

Allied Telesis™
Allied View Network Management System 14.0
(SP0)
Administration Guide
Issue 1

Introduction to the AlliedView NMS Product

Congratulations on your purchase of the Allied Telesis™ Network Management System product. This product allows administrators to query and control all aspects of Allied Telesis products in their network.

Who Should Read This Guide?

This document is for network administrators who need in-depth knowledge of the NMS and its applications. Many of these applications are only available to administrators and allow them to control the actions available to users. (Applications available to users are described in the NMS User Guide.)

About this Guide

This guide includes all aspects of the NMS product and includes information on the installation and administration of the NMS server software.

- Chapter 1 provides an overview of the product, how the document is organized, and the changes that have occurred to both the product and this document since the last release.
- Chapter 2 gives an overview of the installation process and starting up the client interfaces
- Chapter 3 includes the real-time tasks available on the NMS (do not require a server restart).
- Chapter 4 gives the tasks involved in setting up users and their scope of operation.
- Chapter 5 includes the tasks available to control individual devices from both the Rapier and Telesis families.
- Chapter 6 controls how network-spanning features, such as interdevice VLANs, can be easily configured using the AlliedView NMS user interface.
- Chapter 7 includes all aspects of Provisioning Gateways (iMG/RGs)
- Chapter 8 explains how statistics work and how to configure them.
- Chapter 9 explains how the Fault Management application works and how to control alarm outputs.
- Chapter 10 explains the html interface.
- Chapter 11 explains the MIB manager interface.

- Chapter 12 explains the capabilities of the Northbound interface.
- The Appendix explains how to export to a file tabular data displayed in the Fault Management, Performance, and Network Inventory views. For the iMG/RG, it includes sample configuration files.

Tracking Updates since the Previous Release

Section 1 of this document includes a Reason for Update table, allowing the user to see what features have been added or changed. Throughout this document, change bars let the user know where the information oscillated with these changes is located.

There is also an improved explanation for how standard and custom downloads are performed on the NMS.

Reason for Update

This document is being updated to include changes that are part of Release 14.0 (SP0), as well as technical updates.

Also, information for both the SE and EE versions of this product are included. In tables that include SE only information, the rows are highlighted.

Service and Support

For information about support services for Allied Telesis, contact your Allied Telesis sales representative or visit the website at www.alliedtelesis.com.

All company names, logos, and product designs that are trademarks or registered trademarks are the property of their prospective owners.

Table of Contents

1 Product Overview	1-1
1.1 Intended Audience for this Guide	1-1
1.2 How this Document is Organized	1-1
1.3 Reason for Update	1-2
1.4 The AlliedView Network Management System (NMS)	1-3
1.4.1 User Privileges at the NMS and Product Level	1-3
1.4.2 Compatibility of NMS and Device Loads	1-3
1.4.3 Setting Web Browser Caching	1-3
1.4.4 Using Default Prompt for Device Account Used by AlliedView NMS	1-3
1.5 Levels of Support (Enterprise Edition)	1-4
1.6 Managed Devices (Firmware Interop)	1-5
1.6.1 Full Support, Excluding iMG/RG	1-5
1.6.2 Basic Management Support	1-12
1.6.3 iMG/RG Types Supported (3-8-03 and 4-n)	1-14
1.7 Levels of Support	1-15
1.7.1 Overview	1-15
1.7.2 Allied Telesis, AlliedWare, and AlliedWare Plus Products	1-15
1.7.3 AR, AT, and GenBand Products	1-17
1.7.4 Specific Market Devices	1-19
1.7.5 Devices Supported by SwimView	1-22
1.8 Document Conventions	1-23
1.9 How to Use Supporting Documents	1-23
1.9.1 Document Media	1-23
1.9.2 Printing Hardcopy	1-23
1.9.3 Accessing Online	1-23
1.9.4 Using Online Help with NMS	1-23
1.10 Copyrights	1-23
2 Installing and Starting Up	2-1
2.1 Overview	2-1
2.2 AlliedView NMS Installation	2-1
2.3 Starting up AlliedView NMS	2-1
2.3.1 Password Configuration	2-1
2.3.2 Configuration Limits for Clients	2-2
2.4 Using the Logs Console	2-2
2.5 The Application Screen	2-3
2.6 Broadcasting a Message	2-4
2.7 Restart / Shut Down the Server	2-5
2.8 Resource Management	2-6

2.8.1	Setting the Custom Security Policy (Required)	-2-6
2.8.2	Resource Management Table (<i>Tools -> Resource Management</i>)	-2-7
2.8.3	Front-End Monitor	-2-7
2.8.4	Client Memory Monitor	-2-7

3 File Administration ----- **3-1**

3.1	Overview	3-1
3.2	Discovery Configurator (Service Provider)	3-3
3.2.1	Overview	3-3
3.2.2	Schedule Tab	3-3
3.2.3	SNMP Tab	3-5
3.2.4	CWMP Tab	3-6
3.2.5	CLI Logins Tab	3-8
3.2.6	Network Discovery Tab	3-10
3.2.7	Node Discovery Tab	3-12
3.2.8	Other Discovery Tab	3-14
3.2.9	Example Configurations	3-15
3.3	Discovery Configurator (EE)	3-18
3.3.1	Overview	3-18
3.3.2	Basic Tab	3-19
3.3.3	SNMP Tabs	3-21
3.3.4	CWMP Tab	3-22
3.3.5	CLI Logins Tab	3-23
3.3.6	Network Discovery Tab	3-25
3.3.7	Node Discovery Tab	3-26
3.4	Backup and Restore	3-27
3.4.1	AlliedView NMS Backup (On Demand)	3-27
3.4.2	AlliedView NMS Backup (Scheduled)	3-28
3.4.3	Configuring Backup Parameters for AlliedView NMS	3-30
3.4.4	Restore the AlliedView NMS (GUI Screens)	3-30
3.4.5	Device Backup (Per-Device Limit)	3-33
3.5	AlliedView NMS License Manager	3-34
3.5.1	Overview	3-34
3.5.2	Installing a License (Using the License Key Manager)	3-34
3.5.3	Installing a License (Using the Console Mode)	3-36
3.5.4	Verifying the License After Installation	3-37
3.5.5	Viewing the License Configuration	3-38
3.5.6	Migrating Existing Licenses	3-40
3.6	File Keys to Identify Downloadable Files	3-41
3.6.1	Overview	3-41
3.7	Log Files for Debugging the AlliedView NMS Server	3-42
3.8	Commands for the Allied Telesis Tools Submenu	3-43
3.9	Status Monitoring	3-44
3.9.1	Status Table	3-45
3.9.2	Menu Options (Export)	3-48
3.10	Downloading Device Files	3-49

3.10.1 Overview (Standard versus Custom Loads)	3-49
3.10.2 Load Import GUI (Standard Loads)	3-49
3.11 Accessing the NMS Database	3-54

4 Security Administration

4.1 Overview	4-1
4.2 Add a New User	4-3
4.3 User Settings.....	4-6
4.3.1 Overview	4-6
4.3.2 Associating Groups to User.....	4-6
4.3.3 Setting User Profile	4-6
4.3.4 Viewing Audit Trails	4-8
4.3.5 Change the User Password	4-9
4.3.6 Assigning Operations to User	4-9
4.3.7 Delete User	4-10
4.4 Adding a new group	4-10
4.4.1 Group and Scope Settings	4-12
4.4.2 Assigning Users to Group.....	4-14
4.4.3 Assigning Operations to Group	4-14
4.5 Custom View Scope (CVS)	4-14
4.5.1 Overview	4-14
4.5.2 Add Authorized Scope for a Custom View Scope	4-15
4.5.3 Set Authorized Scope for a Custom View Scope	4-15
4.5.4 Set Scope Properties	4-15
4.5.5 Deleting Authorized Scope	4-16
4.6 Permissions Tree	4-16
4.6.1 Overview	4-16
4.6.2 Permissions Tree.....	4-17
4.7 Remote Authorization (RADIUS / Tacacs+) on Devices	4-23
4.7.1 RADIUS	4-23
4.7.2 Tacacs+ (Using the CLI Login Manager).....	4-24
4.8 NMS RADIUS Client Support	4-25
4.8.1 Overview	4-25
4.8.2 RADIUS Configurator Tool (with Valid License)	4-26
4.8.3 Example Configurations	4-33
4.8.4 Feature Interactions (RADIUS Server De-activated or Unavailable)	4-36

5 Controlling and Provisioning Network Devices

5.1 Overview	5-1
5.2 View Chassis.....	5-5
5.2.1 Display Types	5-6
5.2.2 Display of VLAN-based HVLANs (Tunneling)	5-8
5.2.3 Notes on Chassis View	5-9
5.3 Provisioning a Device.....	5-9

5.3.1 Overview of the Provisioning Interface	5-9
5.3.2 Backup/Restore (with Purge Button)	5-14
5.3.3 Command Script Management	5-21
5.3.4 Configuration File Management	5-27
5.3.5 Device Information	5-29
5.3.6 SNMP Agent	5-30
5.3.7 SNMP Community	5-32
5.3.8 Obtaining SW Loads	5-37
5.3.9 Software Configuration (Standard Loads)	5-37
5.3.10 Software Configuration (Custom Loads)	5-48
5.3.11 Using Custom Loads to Reduce Unneeded Card Types	5-59
5.3.12 SysLog Management	5-61
5.3.13 LLDP Protocol and Associated Features (LAG/VCS Monitoring)	5-62
5.3.14 MPEG Test	5-70
5.3.15 Using the Edit Functions	5-77
5.3.16 Using the Delete Function	5-83
5.3.17 SNMPv3 USM Configuration	5-86
5.4 Configure VLAN (Chassis View)	5-87
5.5 Card Management	5-91
5.5.1 Overview	5-91
5.5.2 Accessing the Card Management Application	5-91
5.5.3 Creating a Card (Pre-provisioning)	5-93
5.5.4 GE3 Card	5-96
5.5.5 GE8 Card	5-97
5.5.6 ADSL24A Card	5-97
5.5.7 ADSL24 (Annex B) and ADSL24AE	5-98
5.5.8 SHDSL24 Card (Card-Level vs. Port-Level)	5-98
5.5.9 CFC24 Card in Simplex and Duplex	5-98
5.5.10 CFC56, CFC100, and CFC200 Card	5-101
5.5.11 FE10/FX10 Card	5-101
5.5.12 FX20 Card	5-103
5.5.13 POTS24 Card	5-103
5.5.14 CES8 Card	5-111
5.5.15 NTE8 Card	5-113
5.5.16 ADSL24A, ADSL24B, and ADSL24E Card	5-114
5.5.17 PAC24A, PAC24C Card	5-114
5.5.18 EPON2 Card	5-114
5.5.19 VDSL24 Card	5-114
5.5.20 ADSL48A/B Card	5-114
5.5.21 Viewing Card Details for the iMAP 9100	5-114
5.5.22 GE24POE	5-115
5.5.23 Controlling Card Software (Download and Restart)	5-115
5.5.24 Overview of Provisioning Data, Profiles, and Card States	5-116
5.5.25 Power Over Ethernet (POE) Management on SBx3112	5-117
5.5.26 XE Cards (XE1, XE1S, XE4, XE6SFP, and XE6)	5-119
5.5.27 GE24 Cards (GE24SFP, GE24POE, GE24RJ, GE24BX)	5-119
5.6 Port Management (iMAP Devices)	5-119
5.6.1 Overview	5-119
5.6.2 Accessing the Port Management Application	5-120

5.6.3 Provision New Customer/Port (Triple Play Form) - with Preferences	5-123
5.6.4 Provision New Customer Port for Ethernet	5-128
5.6.5 Provision New Customer/Port for ADSL	5-128
5.6.6 Provision New Customer/Port for CES8 (DS1/E1 Form)	5-129
5.6.7 Provision New Customer/Port for NTE8 (DS1/E1 Form)	5-131
5.6.8 Provision New Customer / Port for SHDSL16/24	5-133
5.6.9 Provision New Customer / Port for EPON2	5-133
5.6.10 Provision New Customer / Port for ONU	5-136
5.6.11 Provision New Customer / Port for VDSL24A/B	5-137
5.6.12 Overview of Triple Play Service Management Form	5-139
5.6.13 Status Tab	5-139
5.6.14 Add Derived Voice Line for GenBand (on Status Tab Form)	5-141
5.6.15 iMG/RG Tab	5-142
5.6.16 Ether-like Config. Tab (Upstream and Downstream)	5-144
5.6.17 ADSL Configuration Tab	5-152
5.6.18 SHDSL Port Management Form	5-170
5.6.19 Voice Port Management (Tabbed Form)	5-174
5.6.20 CES8 Port (DS1/E1 Port Management Tabbed Form)	5-183
5.6.21 NTE8 Port Management Form	5-190
5.6.22 SHDSL Bonding (Card Level to Port Level)	5-200
5.6.23 View the EPON2 Port Configuration	5-202
5.6.24 ONU Configuration (as ON1000 or as part of iMG646PX-ON)	5-204
5.6.25 VDSL24 Port	5-205
5.6.26 Statistics Tab	5-210
5.6.27 Port Log Tab	5-213
5.6.28 DHCP Tab	5-213
5.6.29 FDB Tab	5-213
5.6.30 Video Tab	5-213
5.6.31 ATM Bonding	5-216
5.6.32 STP Tab	5-223
5.7 Port Management (non-iMAP Devices)	5-224
5.7.1 Rapier/Switchblade Devices	5-224
5.7.2 GenBand Reports	5-227
5.7.3 Dual End Line Testing (DELT)	5-229
5.7.4 Single-End Line Testing (SELT)	5-235
5.7.5 Diagnostics for ATMBOND	5-237
5.7.6 Support of CWMP with TR-069 Devices	5-238
5.7.7 POE View / Modify Port	5-249
5.8 Scheduling and Controlling Provisioning Tasks	5-250
5.8.1 One Time	5-250
5.8.2 Recurring	5-251
5.8.3 View Tasks Form	5-252
5.9 Other Device Control Tasks	5-253
5.9.1 Alarms/Events	5-253
5.9.2 Performance	5-253
5.9.3 File Comparison (Text Files)	5-254
5.9.4 Discover Attached iMG/RGs	5-261
5.9.5 Display Switch Forwarding Database (iMAP Systems)	5-261

5.9.6 Telnet / SSH to a Device	5-262
5.9.7 Browse Device (Rapiier Device Only)	5-263
5.9.8 Rediscovery Device (When Required)	5-263
5.9.9 Managed Object Properties	5-263
5.9.10 Manage/Unmanage	5-263
5.9.11 Update Status	5-263
5.10 Manage CLI Users	5-265
5.11 Customer Cutover	5-265
5.11.1 Overview	5-265
5.11.2 Cutover Scenarios/Restrictions	5-265
5.11.3 Procedure Overview	5-267
5.11.4 Procedure Example - Transfer to different cardtype	5-268
5.11.5 Procedure Example - Transfer of iMG to different Port	5-273

6 Configuring Network Services ----- 6-1

6.1 Overview	6-1
6.1.1 Profile Management	6-2
6.1.2 Quality of Service	6-2
6.1.3 Protection Switching (EPSR)	6-2
6.1.4 Circuit Emulation Service (CES)	6-2
6.1.5 NTE8 Service	6-3
6.2 Topology Maps and Inventory Tables	6-3
6.2.1 Overview	6-3
6.2.2 VLAN Network Map (Layer 3)	6-4
6.2.3 VLAN Sub Maps (Layer 2)	6-5
6.2.4 Physical Network Map	6-6
6.2.5 VLAN Interfaces Inventory Table	6-9
6.2.6 Physical Links Inventory Table	6-11
6.2.7 Alarm Indicators from the Maps and Inventory Tables	6-12
6.3 Creating Network VLANs	6-12
6.3.1 Creating Initial VLAN Information	6-12
6.3.2 Modify the Network VLAN Link Configuration	6-13
6.3.3 Configure the VLAN Interfaces (Service Ports)	6-15
6.4 Extending Network VLANs	6-18
6.5 Trimming or Splitting Network VLANs	6-21
6.6 Deleting Network VLANs	6-21
6.7 Network VLAN Manager (Excluding EPSR)	6-22
6.7.1 Overview	6-22
6.7.2 Create Network VLAN	6-22
6.7.3 Using the Network VLAN Hierarchy	6-23
6.7.4 Using the Device VLAN Hierarchy	6-24
6.7.5 Importing Physical Link Configurations	6-25
6.7.6 Exporting Physical Link Configurations	6-27
6.7.7 Viewing VLAN Outage Statistics	6-28
6.8 Example of Creating Network VLANs	6-30
6.8.1 Sample Island-Based Network VLAN	6-30

6.8.2 Extending the Island-Based VLAN	6-36
6.9 Example Configurations for HVLAN, Translations	6-39
6.9.1 Overview	6-39
6.9.2 HVLAN Configuration	6-39
6.9.3 VLAN Translations Configuration	6-46
6.10 Profile Management	6-47
6.10.1 Profile Configuration Parameters - Devices and Scoping	6-48
6.10.2 Creating a Profile	6-52
6.10.3 Viewing and Modifying Profiles	6-55
6.10.4 Deleting a Profile	6-55
6.10.5 Deploying a Profile	6-56
6.10.6 Redeploying a Profile	6-59
6.10.7 Scheduling Deployment of a Profile	6-59
6.10.8 Deploying Changes to a Profile	6-60
6.10.9 Profile Monitoring	6-60
6.10.10 Keeping the Profile Parameters and Ports/Devices in Sync	6-61
6.10.11 Coordination of External and NMS Profiles	6-61
6.10.12 ADSL G.Bond Creation and use of Profiles	6-64
6.10.13 Multiple VC Support on ADSL Port	6-65
6.10.14 Multiple VC Support on SHDSL Port	6-65
6.10.15 Multiple VC Support on VDSL Port	6-65
6.10.16 DS3 SFP Support	6-72
6.10.17 Changes for the Enterprise Edition	6-77
6.11 Quality of Service (QoS) Network Management	6-82
6.11.1 Overview	6-82
6.11.2 QoS Flows	6-88
6.11.3 QoS Priority Action	6-91
6.11.4 QoS Traffic Action Form	6-94
6.11.5 QoS Policy Action Form	6-98
6.11.6 QoS Policy Maintenance Window (Defining a Policy)	6-100
6.11.7 QoS Policy Rule Form	6-102
6.11.8 Viewing Default Flows, Priorities, Actions, and Policies	6-103
6.11.9 Example of an iMAP Device Class Policy	6-104
6.11.10 Example of a Rapier/SwitchBlade Policy	6-106
6.11.11 Example of an EPON/ONU Interface Policy	6-113
6.11.12 QoS Policies for the FX20 Interface	6-118
6.12 Troubleshooting Policies and Profile Management	6-125
6.12.1 Overview (QoS Deployments Table)	6-125
6.12.2 Determine which QoS Policy is Assigned to a Port	6-125
6.12.3 Determine Whether a QoS Policy is Deployed and In-sync on a Device	6-125
6.12.4 Determine whether a QoS Policy has the Desired Configuration	6-126
6.12.5 Redeploying Policies	6-126
6.13 Protection Switching-EPSR	6-129
6.13.1 Overview of EPSR Topology	6-129
6.13.2 The Network VLAN Manager Application - Configure Control Ring	6-131
6.13.3 The Network VLAN Manager Application - Configure Data Ring	6-137
6.13.4 Configuration Guidelines	6-139
6.13.5 Example Scenario	6-140

6.13.6	Troubleshooting the EPSR Configuration	6-150
6.13.7	Status of Transit Nodes for AlliedWare Plus Devices	6-156
6.14	SuperLoop Prevention (Superring)	6-157
6.14.1	Overview	6-157
6.14.2	Creating the EPSR SuperRing	6-159
6.15	Customer Management	6-175
6.15.1	Overview	6-175
6.15.2	Add New Triple Play Customer - Four Examples	6-175
6.15.3	Add DS1/E1 Customer	6-180
6.15.4	View/Modify Customer Ports	6-180
6.15.5	Deprovision Customer Ports	6-182
6.16	Circuit Emulation Service	6-183
6.16.1	Overview (CES8 and iMG6x6MOD Configurations)	6-183
6.16.2	CES8 Configuration - Overview of Steps	6-184
6.16.3	Create/Provision CES8 card to Support DS1 Ports (Same Device)	6-185
6.16.4	Create DS1 Profile (DS1 and P-SPAN)	6-186
6.16.5	Provision the Two DS1 Ports	6-187
6.16.6	View Provisioning Results	6-189
6.16.7	Provisioning iMG6x6MOD with T1/E1 Card and CES	6-196
6.17	NTE8 Dual Circuit Provisioning	6-213
6.17.1	Main Provisioning Steps	6-214
6.17.2	Create/Provision NTE8 cards to Support DS1 Ports (Different Devices)	6-215
6.17.3	Create DS1 Profile	6-215
6.17.4	Provisioning one NTE8 Circuit	6-217
6.17.5	Adding PPPs to the MLPPP	6-219
6.17.6	Viewing Provisioning Results - Port Inventory Table	6-221
6.17.7	Viewing Provisioning Results - Port Details Form	6-221
6.17.8	Viewing NTE8 Endpoints on Physical Map	6-229
6.17.9	Viewing NTE8 Configuration Faults	6-230
6.18	Upstream Control Protocol (UCP) Display	6-230
6.18.1	VLAN Submap Display	6-231
6.18.2	Network Inventory Display	6-231
6.18.3	Events View (Change of State)	6-232
6.19	Link Discovery	6-233
6.20	Software Upgrade with EPSR	6-234
6.20.1	Overview	6-234
6.20.2	Upgrading all Nodes for an EPSR Ring	6-234
6.20.3	Upgrading One Node that is part of an EPSR Configuration	6-238
6.20.4	Upgrading Devices when EPSR not Properly Configured	6-240
6.21	Diagnostic Audit	6-241
6.21.1	Network VLANs	6-241
6.21.2	Audit the CES Circuit on the iMG6x6MOD or CES8 Card	6-244
6.22	Port Authentication (802.1x)	6-247
6.22.1	Port Authentication for a Device	6-247
6.22.2	Profiles with the Port Authentication Feature	6-250
6.22.3	Etherlike Port Profile	6-253
6.22.4	Feature Support (AlliedWare Plus and iMAP Devices)	6-254

7 Provisioning the iMG/RG-----7-1

7.1 Overview----- 7-1

7.1.1 Roadmap for this Section----- 7-1

7.2 Provisioning Strategy ----- 7-2

7.2.1 Main Concepts (Profiles, Triple Play Form, DHCP Discovery) ----- 7-2

7.2.2 Deployment Models (Access Islands, Open Access, multi-service VLANs) ----- 7-2

7.2.3 iMG/RG Types Supported ----- 7-6

7.2.4 Provisioning Strategies ----- 7-7

7.2.5 Configuring Components for DHCP Discovery----- 7-8

7.2.6 Naming Conventions to Identify Components (DNS)----- 7-20

7.2.7 Naming Convention for Customer IDs (Triple Play Form) ----- 7-25

7.2.8 Changing Customer IDs ----- 7-25

7.3 Viewing iMG/RG on the AlliedView NMS ----- 7-27

7.4 Creating RG Profiles with Field Descriptions ----- 7-29

7.4.1 Overview ----- 7-29

7.4.2 General Profile----- 7-29

7.4.3 RG Internet Profile ----- 7-38

7.4.4 Video Profile ----- 7-51

7.4.5 Voice Port Profile ----- 7-53

7.4.6 Business Group ID for SIP----- 7-58

7.5 Basic Configurations with Sample Profiles ----- 7-59

7.5.1 Overview ----- 7-59

7.5.2 Transparent LAN Service (TLS)----- 7-60

7.5.3 Internet - Bridged ----- 7-62

7.5.4 Internet - Routed ----- 7-64

7.5.5 Internet - Routed - NAT----- 7-67

7.5.6 Video - Snooping ----- 7-71

7.5.7 Video - Proxy ----- 7-73

7.5.8 Voice - Public and Private ----- 7-75

7.5.9 ADSL iMG with multiple VCs ----- 7-78

7.6 Datafilling the Triple Play Form - Examples----- 7-83

7.6.1 Overview ----- 7-83

7.6.2 Configuration 1 Example - POTS, Derived Voice, Internet, Video, TLS ----- 7-84

7.6.3 Configuration 2 - Multiple Video, Data, Derived Voice ----- 7-87

7.6.4 Configuration 3 - Static Provisioning (no DHCP) ----- 7-89

7.6.5 Configuration 4 - EPON/ONU Interface Connected with iMG646PX-ON ----- 7-99

7.6.6 Configuration 5 - Voice Service Provided by SIP----- 7-102

7.6.7 Configuration 6 - Multi-Service VLAN ----- 7-104

7.6.8 Configuration 7 - iMG7x6MOD with HPNA ----- 7-109

7.6.9 Configuration 8 - AlliedWare Plus Device ----- 7-113

7.6.10 Configuration 9 - Microsoft© Mediaroom™ with the iMG/RG ----- 7-115

7.6.11 Configuration 10 - Video with static IP Address (iMG1000 and 2000 Series) --- 7-122

7.7 Provisioning the iMG/RG (Managed Object Properties) ----- 7-124

7.7.1 Overview ----- 7-124

7.7.2	Managed Object Properties for the iMG/RG	7-124
7.7.3	Creating Custom Views for an Access Island	7-128
7.8	Provisioning the iMG/RG (Application Manager)	7-136
7.8.1	Overview	7-136
7.8.2	Backup/Restore	7-137
7.8.3	Device Configuration	7-137
7.8.4	Software Configuration	7-137
7.9	Provisioning Guidelines for Models	7-138
7.9.1	Open Access	7-138
7.9.2	Multi-service VLANs	7-141
7.9.3	iMG6x6MOD/iMG7x6MOD - Translation and HPNA Diagnostics	7-142
7.9.4	iBG915-FX	7-146
7.9.5	iMG with WAN 1G Module	7-154
7.9.6	Split Management for Wireless iMG	7-160
7.9.7	Changing VoIP Endpoint Syntax	7-166
7.9.8	Provisioning Custom VLANs	7-167
7.9.9	Error Conditions when Provisioning	7-170
7.10	Installation Procedures	7-171
7.10.1	Overview	7-171
7.10.2	Installation Restrictions	7-171
7.10.3	Pre-provision Future Customer (Provision iMAP Port, no Services)	7-172
7.10.4	Provision a new Customer (out of the box) - Triple Play	7-176
7.10.5	Provisioning / De-Provisioning Voice Service	7-181
7.10.6	Provisioning / De-Provisioning Video Service	7-190
7.10.7	Change Quality of Existing Data Service	7-198
7.10.8	Reprovision Existing iMG/RG so incorporated into AlliedView NMS	7-199
7.10.9	De-Provision iMG/RG from AlliedView NMS	7-199
7.10.10	Changing a Customer ID	7-204
7.10.11	iMG/RG Recovery	7-205
7.10.12	Recover using new Hardware	7-205
7.10.13	Configuring multi-service VLAN	7-206
7.11	Provisioning the iMG/RG (no iMAP or AW+)	7-226
7.11.1	Overview	7-226
7.11.2	DHCP Provisioning	7-226
7.11.3	GUI Provisioning	7-229
7.11.4	GUI Displays	7-231
7.12	Provisioning an iMG/RG with the LAN4 Feature	7-232
7.12.1	Overview	7-232
7.12.2	Profiles	7-232
7.12.3	Service Management GUI	7-234
7.12.4	Custom View	7-234
7.12.5	Procedure - Initial Installation of iMG with LAN4	7-238
7.12.6	Deprovision the iMG and Re-provision with the ADSL Uplink	7-241
7.13	LCFO	7-243
7.14	iMG/RG Diagnostic Features	7-245
7.14.1	iMG GR909 Diagnostics	7-245
7.14.2	iMG LAN Diagnostics	7-247
7.15	System Power Management	7-250

7.15.1 System Power Management	7-250
7.15.2 LAN Ports Power Management	7-252
7.15.3 LAN Ports State	7-253
7.15.4 TEL Ports Power Management	7-255
7.15.5 Voice Ports State	7-255
7.16 LAN Flow Control	7-256
7.17 Port-Based Rate Limiting - Reference	7-258

8 Setting Up Performance Management -----8-1

8.1 Overview	8-1
8.2 Data Collection Screen	8-2
8.2.1 Overview	8-2
8.2.2 Screen Components for Statistics	8-2
8.3 Data Collection	8-3
8.3.1 Overview	8-3
8.3.2 Polling Objects	8-4
8.3.3 Add a Statistic	8-8
8.4 Threshold Notification	8-11
8.4.1 Overview	8-11
8.4.2 Add Threshold	8-13
8.4.3 Associate Thresholds with Statistics	8-15

9 Setting Up Fault Management -----9-1

9.1 Overview	9-1
9.1.1 AlliedView NMS Fault Management Configuration	9-1
9.1.2 Task Overview	9-2
9.2 Event View	9-3
9.3 Configuring Trap Parsers	9-3
9.3.1 Using Trap Values in the PDU	9-6
9.3.2 Loading from a MIB	9-8
9.3.3 Loading from a File	9-8
9.3.4 Reordering the Trap Parser List	9-9
9.4 Configuring Event Parsers	9-9
9.4.1 Overview	9-9
9.4.2 Setting Event Parsers	9-10
9.4.3 Relationship Between User Properties and Custom Views	9-13
9.4.4 Setting up a SYSLOG Event to Create an Alarm	9-13
9.4.5 Changing Severity of Default Events (i.e. Status Update Failure)	9-14
9.4.6 Changing Severity of Port-based Alarms	9-19
9.5 Configuring Event Filters	9-20
9.5.1 Overview	9-20
9.5.2 Setting Event Filters	9-22
9.5.3 Setting Event Filter Actions	9-24
9.5.4 Example of Setting an Event Filter Action	9-26

9.5.5	Setting Up Event Filters for SYSLOG Events	9-27
9.6	Configuring System Logs (NMS System Log Server)	9-27
9.6.1	Configuring the System Log Server	9-29
9.6.2	Applying Log Filters	9-30
9.6.3	Configuring Log Actions	9-31
9.6.4	Viewing Logs	9-31
9.6.5	Disabling and Re-enabling Logs from a Device	9-32
9.6.6	OTHER Event Type	9-32
9.7	Alarm View Display	9-32
9.8	Alarm Propagation	9-34
9.8.1	Overview	9-34
9.8.2	Controlling Alarm Propagation	9-34
9.9	Configuring Alarm Filters	9-36
9.9.1	Overview	9-36
9.9.2	Example to Configure Alarm Filter and Actions	9-37
9.10	Retrieval of Alarms during (Re)Discovery (Telesis MAP Devices Only)	9-43
9.10.1	Overview	9-43
9.10.2	Enable / Disable the Feature (Feature is Optional)	9-43
9.10.3	Restrictions / Limitations	9-44

10 Using the HTML Interface ----- 10-1

10.1	Overview	10-1
-------------	-----------------	-------------

11 Built-in Browsers - SNMP MIB and CWMP ----- 11-1

11.1	Overview - SNMP MIB	11-1
11.2	MIB Browser Screen and Toolbar	11-2
11.3	Loading and Unloading MIBs	11-3
11.3.1	Overview	11-3
11.3.2	Loading Options (Directly, as Compiled Files, Using MySQL)	11-4
11.3.3	Loading MIBs as Compiled Files	11-4
11.3.4	Loading MIBs from a Database	11-5
11.3.5	Loading MIBs Using MySQL	11-5
11.3.6	Unloading MIBs	11-6
11.4	MIB Browser Settings	11-6
11.5	SNMP Operations	11-6
11.5.1	Multi-Varbind Request	11-6
11.6	MIB Browser – Table Operations	11-7
11.7	Trap Viewer	11-9
11.8	Trap Parser	11-10
11.8.1	Overview	11-10
11.8.2	Procedure to Create a Parser File	11-12
11.8.3	Adding a Trap Definition from MIBs to a Parser File:	11-13
11.8.4	Filtering Incoming Traps	11-13
11.8.5	Setting Trap Parser Parameters	11-13

11.9 Graphs	11-14
11.10 CWMP	11-15

12 Northbound Interface - - - - - **12-1**

12.1 Overview	12-1
12.2 SOAP Implementation	12-2
12.2.1 Overview (Apache Axis)	12-2
12.2.2 WSDL	12-3
12.2.3 Web Services	12-3
12.3 User Interaction	12-4
12.3.1 Web Services Activation	12-4
12.3.2 User Security	12-5
12.3.3 Operation Threshold Activation	12-5
12.3.4 Axis/SOAP Interface Client Development - Examples	12-5
12.3.5 Available Operations	12-6
12.3.6 Provision Parameters	12-9

13 Appendices - - - - - **13-1**

13.1 Exporting Tabular Data	13-1
13.1.1 Exporting the Entire Table	13-1
13.1.2 Exporting Selected Items	13-5
13.1.3 Viewing a Data Export File	13-6
13.1.4 Viewing Data on a Web Browser	13-7
13.2 dhcpd Files	13-9
13.2.1 dhcpd.conf	13-9
13.2.2 dhcpd Includes	13-11
13.2.3 DNS Configuration File	13-30



1. Product Overview

1.1 Intended Audience for this Guide

This document is for those who are responsible for all aspects of configuring and administrating the network or networks they manage. After reading this document, the user should be able to control all aspects of the AlliedView NMS and be able to instruct all users on tasks they may perform and the impact of any changes they have made.

1.2 How this Document is Organized

The document covers all areas of administration that are controlled through the AlliedView NMS Application interface and should be performed by the Administrator, such as:

- Discovery (filters and configurator)
- Topology
- Maps
- Security Management
- Configuration Management
- Fault Management
- Performance Management
- MIB Management

1.3 Reason for Update

The following tables list the updates for Release 14.0.

TABLE 1-1 Changes to the AlliedView NMS Administration Guide in Release 14.0 (SP0)

Feature	12.5 Functionality	14.0 Functionality	Notes
LAG Auto negotiation	For iMAP and SBx3112, ports needed to be compatible with manual settings. If link was set to Auto Negotiate, could not be included in LAG.	Link can be set to Auto Negotiate, and if links are compatible, it will be included. If the link is incompatible, the link is excluded and an alarm is generated.	There is no change to NMS functionality, except for reporting of new log messages “Bandwidth Degraded” when one of the LAG links is down (INTF001), and “Link Attribute Mismatch” when a LAG member port does not match the operational physical attributes (speed or duplex settings) of the links already in the LAG. Refer to 5.3.13.3 .
Device Support	Refer to tables in this section in the 12.5 release.	Devices and device categories are added, and include: <ul style="list-style-type: none"> - x200 series - x210 series - x610-24SPs-X model - FS9xxM-PS devices 	Refer to tables in this section.
Card Support	Refer to tables in this section in the 12.5 release	The GE40CSFP card, used in the SBx3112 device, is supported. The x6EM-XS2 card, used in the TBS, is supported.	
8000S and 8000GS VLAN Provisioning	Not Supported	Supported	Refer to Table 1-8 .
Internationalization	Not Supported	Support of Japanese language	The NMS client can be in Japanese.
Load names for SBx3112 cards	Different names for different line cards	All line cards have a common load-name, x31sma_16.x.x.tar. Line cards include: <ul style="list-style-type: none"> GE40CSFP GE24RJ GE24POE GE24SFP XE6SFP XE4 	A custom load must be built. Refer to 5.3.10.1 .

1.4 The AlliedView Network Management System (NMS)

For managing a network, the AlliedView NMS product provides a powerful client that presents the network and its devices in a user-friendly way, allowing its users to learn quickly how the network is configured, how to reconfigure elements when necessary, and how to spot problems (or potential problems) before they degrade network performance.

The version of the AlliedView NMS release is shown in the main menu window, as shown in the following figure.

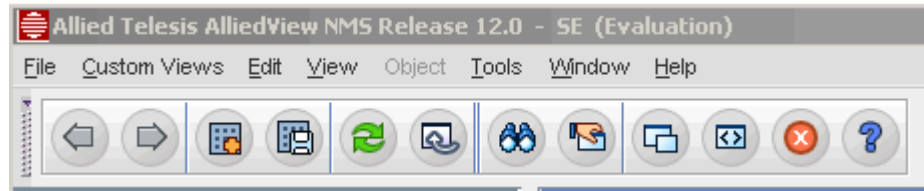

FIGURE 1-1 AlliedView NMS 12.0 GUI (for the SE Version)

To set up the AlliedView NMS product, the Administrator must first set up the AlliedView NMS product on a server configuration. Once the AlliedView NMS software is installed, the Administrator can query and control all aspects of the network by changing the file configuration on the server or making changes using a client.

1.4.1 User Privileges at the NMS and Product Level

At the AlliedView NMS, groups are created and assigned actions that can be performed at the AlliedView NMS. Moreover, users can be assigned to a group, so that they inherit the privileges of that group. Users can also be defined outside a group.

Caution: *At the device, there is a user name and password used to access the device, and this name/password is used by all NMS users when accessing a device. To enable NMS users to query and control a device, the device name and password must be at a security officer level. Failure to do so may make certain operations performed at the NMS on a device to fail.*

1.4.2 Compatibility of NMS and Device Loads

All of the tables in this Section about device support always assume that the NMS 12.0 load is being used. This is to ensure that the NMS can support the latest version of a device.

Caution: *Always ensure that you have the latest NMS load (12.0). If you upgrade a device to the loads listed in Table 1-3 and are not running NMS 12.0, the NMS may not be able to manage the device.*

1.4.3 Setting Web Browser Caching

The web browser caching function should be set to always check for updates from the server before retrieving content from cache. Refer to the AlliedView NMS User Guide for details.

1.4.4 Using Default Prompt for Device Account Used by AlliedView NMS

Caution: *One feature for AT and iMAP devices is the ability to change their default prompts to a custom string. For AT devices, the default prompt ends with ">" and is required, and therefore should not be changed/eliminated. For iMAP devices, there are no restrictions.*

1.5 Levels of Support (Enterprise Edition)

The Enterprise Edition is introduced primarily for the smaller enterprise customer managing a network of less than 100 devices. All features of the Service Provider Edition (SE) are supported in the Enterprise Edition with the exception of customer provisioning of voice, video, and data services. Upgrade to the Service Provider Edition will be available in a future release.

The following table summarizes the main aspects of the Enterprise Edition version of NMS, with references to additional information.

TABLE 1-2 Enterprise Edition Feature Set

Feature	Description when used in Enterprise Edition	Reference
Licensing process	The licensing process remains the same, with the customer receiving a license file and using the License Manager GUI to apply the license. On a running system, the License Keys option for the Status Monitoring Tool shows that the license is Service Provider or Enterprise Edition.	AlliedView NMS Installation Guide, Appendix B.
Show current license once installed	The License Keys option for the Status Monitoring Tool shows that the license is Service Provider or Enterprise Edition. The title bar or the NMS GUI includes the text Service Provider or Enterprise Edition	Refer to 3.9.
Platforms Supported	Windows 2003/2008 Server, Windows XP, Windows 7	
Discovery Configurator	A separate Discovery Configurator Interface is used, with changes to the GUI that match the Enterprise Edition discovery features.	Refer to 3.3
Devices Supported	These are the same as with the Service Provider Edition, as well as monitoring of non_ATI devices.	Refer to 1.7
Triple Play Customer Management	Triple Play provisioning of voice, video, and data services are not supported by the Enterprise Edition NMS. Therefore, changes to the GUI that reflect the Enterprise Edition feature set are: <ul style="list-style-type: none"> - Under the Tools menu, Customer Management option is not available. - In the Ports table, right click on ports does not include <i>Provision New Customer Port</i>. - Right click on iMG/RG from list does not include: <ul style="list-style-type: none"> - <i>Provision New Customer iMG/RG</i> - <i>Deprovision Customer iMG/RG</i> - <i>MPEG Test</i> - In Port Management window, buttons do not allow provision / deprovision of customer port. - For <i>Network Services</i> -> <i>Profiles</i>, CPE Customer Profiles is removed. 	Refer to 6.10.17.

1.6 Managed Devices (Firmware Interop)

1.6.1 Full Support, Excluding iMG/RG

Table 1-3 lists the devices that the AlliedView NMS 12.0 supports. More details about the support features for specific products is included in subsequent tables, since there may not be full support for all features.

Note: Because of the Firmware Decoupling feature, there is no need for a column “Upgradeable Firmware (Patch)”. The user obtains these files separately, and the Software Configuration selects which files are compatible and which files can be deleted. Refer to 5.3.9.

TABLE 1-3 Device Support for the AlliedView NMS 14.0

Family (Level of Support)	Devices	Latest Compatible Firmware ¹	Notes
AT-AR100	AT-AR160 AT-AR130		
AT-AR200	AT-AR250E	1.0.6	Use AT Loader for upgrade (For AT Loader, contact your Allied Telesis representative or go to the ATI website.)
AT-AR260	AT-AR260S AT-AR260S v2		
AT-AR300	AT-AR300 AT-AR300 v2 AT-AR300L AT-AR300L v2 AT		Use AT Loader for upgrade (For AT Loader, contact your Allied Telesis representative or go to the ATI website.) TBS
AT-AR410	AT-AR410 AT-AR410 v2	2.7.1-*	NMS 12.0 End-of-Life (EOL)
AT-AR415	AT-AR415S	2.9.1	NMS 12.0 End-of-Life (EOL)
AT-AR440	AT-AR440S	2.9.1-*	NMS 12.0 End-of-Life (EOL)
AT-AR450	AT-AR450S		
AT-AR442	AT-AR442S	2.9.1	NMS 12.0 End-of-Life (EOL)
AT-AR700	AT-AR720 AT-AR740 AT-AR740DC	2.6.*-*	NMS 12.0 End-of-Life (EOL)
	AT-AR725 AT-AR725DC AT-AR745 AT-AR745DC	2.9.1-*	NMS 12.0 End-of-Life (EOL)
	AT-AR750S	2.9.1-*	NMS 12.0 End-of-Life (EOL)
	AT-AR770S	2.9.1-*	NMS 12.0 End-of-Life (EOL)

TABLE 1-3 Device Support for the AlliedView NMS 14.0

Family (Level of Support)	Devices	Latest Compatible Firmware ¹	Notes
AT-8000	AT-8012M AT-8012MQS AT-8016FMT AT-8016FSC AT-8016FST AT-8016XL AT-8024 AT-8024GB AT-8024M AT-8026FC AT-8026T AT-8088MT AT-8088SC	3.3.*	NMS 12.0 Support End-of-Life (EOL)
AT-8000S	AT-8000S/16 AT-8000S/24 AT-8000S24/POE AT-8000S/48 AT-8000S/48POE	3.0.0.*	Full range of support is 1.0.0.19 up to 3.0.0.44.
AT-8000GS	AT-8000GS/24 AT-8000GS24/POE AT-8000GS/48	2.0.0.*	
AT-8100S (AlliedWare Plus)	AT-8100S/24C AT-8100S/24 AT-8100S/24POE AT-8100S/48 AT-8100S/48POE	2.2.2.*	Other devices going up to 2.2.2.*. Moreover, these devices must be upgraded to 2.2.2.* to be discovered correctly by NMS 12.4. When the SNMP function under the SNMP Agent provision menu is enabled after disabling it through that same menu, only the public community is restored; the private community is deleted/erased.
AT-8200	AT-8224XL AT-8224SL AT-8216XL AT-8216FXL/SC AT-8216FXL/SMSC		
AT-8300	AT-8312 AT-8324	2.0.*	NMS 12.0 End-of-Life (EOL)

TABLE 1-3 Device Support for the AlliedView NMS 14.0

Family (Level of Support)	Devices	Latest Compatible Firmware ¹	Notes
AT-8500	AT-8516FSC AT-8524M AT-8525 AT-8525 AT-8524POE AT-8550GB AT-8550SP	1.4.*	NMS 12.0 End-of-Life (EOL)
AT-8600	AT-8624POE AT-8624T/2M AT-8624XL AT-8624PS AT-8624EL AT-8648T/2SP	2.9.1-20	
AT-8700	AT-8724XL AT-8724XLDC AT-8724XLDCNEBS AT-8748XL AT-8748XLDC AT-8748SL AT-8748SL V2	2.9.1-20	Not supported: 2.6.1-04+ 2.6.2 2.6.3
AT-8800	AT-8824 AT-8824DC AT-8848 AT-8848DC	2.9.1-20	NMS 12.0 End-of-Life (EOL)
AT-8900 (Full Support)	AT-8948	2.9.1-20	If an AT-8900 is part of an EPSR Domain, then to support EPSR management from the NMS, the NMS must be set as an SNMPv2 trap host on the device.

TABLE 1-3 Device Support for the AlliedView NMS 14.0

Family (Level of Support)	Devices	Latest Compatible Firmware ¹	Notes
AT-9000	AT-9000/28 AT-9000/28SP AT-9000/52	2.1.2	<p>LLDP and LLDP-MED for this device is not supported in NMS release 12.2; values cannot be retrieved through SNMP (available lldp mibs does not return corresponding values).</p> <p>Mode LED indicator is fixed in the ACT Mode. The NMS has no provision for Mode Selection.</p> <p>Provision/De-provision button under Port Management is disabled since Profile Management function is not supported.</p> <p>When SNMP function under SNMP Agent provision menu is enabled after disabling it through that same menu, only the public community is restored; private community is deleted/erased.</p>
AT-9100	AT-9108		
AT-9600	AT-9606SX/SC AT-9606T		
AT-9700	AT-9724TS AT-9748TSXP	3.03	
AT-9800	AT9812T AT9812TDC AT9812TF AT9816GB AT9816GBDC AT9816GF	2.9.1-20	
AT-9900	AT-9924SP AT-9924T AT-9924T4SP	2.9.1-20	If an <AT-9900> is part of an EPSR Domain, then to support EPSR management from the NMS, the NMS must be set as an SNMPv2 trap host on the device.
AT-9900s	AT-9924Ts	3.2.1-03	If an <AT-9900s> is part of an EPSR Domain, then to support EPSR management from the NMS, the NMS must be set as an SNMPv2 trap host on the device.
AT-x200	AT-x200-GE-28T AT-x200-GE-52T		
AT-x210	AT-x210-9GT AT-x210-16GT AT-x210-24GT		

TABLE 1-3 Device Support for the AlliedView NMS 14.0

Family (Level of Support)	Devices	Latest Compatible Firmware ¹	Notes
x600 (AlliedWare Plus)	AT-x600-24Ts AT-x600-24TsXP AT-x600-24Ts-POE AT-x600-48Ts AT-x600-48TsXP AT-x600-24Ts-POE+	5.4.2-*	The AlliedWare Plus x600 Series does not allow the modification of the Enhanced Recovery Mode if the EPSR domain is currently enabled. If a user attempts to do this, an error message is displayed. If an x600 is part of an EPSR Domain, then to support EPSR management from the NMS, the NMS must be set as an SNMPv2 trap host on the device.
x610 (AlliedWare Plus)	AT-x610-24Ts AT-x610-24Ts-PoE+ AT-x610-24Ts/X AT-x610-24Ts/X-PoE+ AT-x610-48Ts AT-x610-48Ts-PoE+ AT-x610-48Ts/X AT-x610-48Ts/X-PoE+ AT-x610-24SPs/X	5.4.2-*	The AlliedWare Plus x610 Series does not allow the modification of the Enhanced Recovery Mode if the EPSR domain is currently enabled. If a user attempts to do this, an error message is displayed. If an x610 is part of an EPSR Domain, then to support EPSR management from the NMS, the NMS must be set as an SNMPv2 trap host on the device. The Stack-XG card can be swapped during operation (e.g. to replace a faulty card), but for stacking to be activated the unit must be rebooted. (Stacking will not start unless the card is already inserted and the unit is rebooted.)
x900 (AlliedWare Plus)	x900-12XT/S ATx900-24XS ATx900-24XT ATx900-24XT-N	5.4.2-*	The AlliedWare Plus x900 Series does not allow the modification of the Enhanced Recovery Mode if the EPSR domain is currently enabled. If a user attempts to do this, an error message is displayed. If an x900 is part of an EPSR Domain, then to support EPSR management from the NMS, the NMS must be set as an SNMPv2 trap host on the device.
x900 AlliedWare	900-24XS 900-24XT	3.2.1-03	
x900 - 48	x900-48FE x900-48FS	2.9.1.20	
GenBand	GB-G6	8-1-11 10-4-10	Supported for provisioning of MGCP voice lines and configuration backup and restore.
GenBand	GB-G2	1.2.0	Functionally the same as the G6
RG107	RG107TX		

TABLE 1-3 Device Support for the AlliedView NMS 14.0

Family (Level of Support)	Devices	Latest Compatible Firmware ¹	Notes
RG203	RG203TX-SIP/H323 RG203TX v2-SIP/H323		
RG213	RG213-H323 RG213-MGCP RG213-SIP	6.*	NMS 12.0 End-of-Life (EOL)
Rapier (Full Support)	Rapier24 Rapier48	2.3.1-* 2.7.0-*	NMS 12.0 End-of-Life (EOL)
Rapier "G"	RapierG6 RapierG6flx RapierG6fmt RapierG6fsx	2.7.3-09	NMS 12.0 End-of-Life (EOL)
Rapier "i" (Full Support)	Rapier24i Rapier24iDCNEBS Rapier48i Rapier 48W	2.9.1-20	NMS 12.0 Support End-of-Life (EOL)
SwitchBlade (AlliedWare)	SB4104AC SB4104DC SB4108AC SB4108DC	2.7.5-09	NMS 12.0 Support End-of-Life (EOL)
SwitchBlade (AlliedWare Plus)	AT-SBx908	5.4.2-*	The AlliedWare Plus SBx908 Series does not allow the modification of the Enhanced Recovery Mode if the EPSR domain is currently enabled. If a user attempts to do this, an error message is displayed. If an SBx908 is part of an EPSR Domain, then to support EPSR management from the NMS, the NMS must be set as an SNMPv2 trap host on the device.
SwitchBlade (iMAP)	SBx3112	16.0.*	
Telesis T1000	T1000	1.3.* 1.6.*	NMS 12.0 Support End-of-Life (EOL)

TABLE 1-3 Device Support for the AlliedView NMS 14.0

Family (Level of Support)	Devices	Latest Compatible Firmware ¹	Notes
iMAP (Full Support)	7100 7101 7102 7103 7104 7105 7112 7115 7400 7700	6.1.12	NMS 12.0 Support End-of-Life (EOL)
iMAP 9000 (Full Support)	9400 9700 9810	16.0.*	iMAP releases are supported up to two releases prior to the current release. Therefore, in release 12.0, releases prior to iMAP 11.0 are not supported.
iMAP 9000 (Full Support)	9100 9101 9102 9103	16.0.*	
iMAP 9000 (Full Support)	9400-56 9700-56	16.0.*	
DTM	NM1000	-	NMS 12.0 Support End-of-Life (EOL)
MC2700	CentreCOM-MC2700	1.2.*	
CentreCom AR Series	AR415S AR550S AR560S AR570S	2.9.2-00	LLDP configuration per port is not supported and will return a 'Function not supported' error.
CentreCom 8000 Series	8324XL 8316XLR 8324XLR 8424TX 8424XL	2.7.9-*	LLDP configuration per port is not supported and will return a 'Function not supported' error.
CentreCom 9400 Series	CentreCOM-9424T	4.*	
	CentreCOM-9424T-SP	2.*	
FS Series	CentreCOM-FS926M CentreCOM-FS917M CentreCOM-FS909M	1.6.9	
	CentreCOM-FS926M-PS CentreCOM-FS917M-PS CentreCOM-FS909M-PS	1.6.9	

TABLE 1-3 Device Support for the AlliedView NMS 14.0

Family (Level of Support)	Devices	Latest Compatible Firmware ¹	Notes
	CentreCOM-FS808M	1.0.3	
GS Series	CentreCOM-GS924M	1.6.6	
	CentreCOM-GS916M		
	CentreCOM-GS908M		
	CentreCOM-GS924M v2	2.1.0	
	CentreCOM-GS916M v2		
	CentreCOM-GS908M v2		
CentreCom 9048XL	CentreCOM 9048XL	2.1.0	

1. Compatible Firmware defines the device software releases that the NMS is able to manage. Refer to the Allied Telesis website for specific load information.

1.6.2 Basic Management Support

Table 1-4 lists the devices in which the NMS provides basic management support (Network Inventory, IP Maps, Alarms).

TABLE 1-4 Devices Supported by NMS - Network Inventory, IP Maps, Alarms

Family	Devices	Notes
AT-9400	AT-9408LC-SP AT-9424T AT-9424T-GB AT-9424T-POE AT-9424TS AT-9424T-SP AT-9424TS-XP AT-9448T-SP AT-9448TS-XP	NMS 12.0 Support End-of-Life (EOL)
AT-8324XL	AT-8324XL	NMS 12.0 Support End-of-Life (EOL)
AT-8724SL		NMS 12.0 Support End-of-Life (EOL)
AT-8748XL	AT-8748XL	NMS 12.0 Support End-of-Life (EOL)
AT-AR550S	AT-AR550S	NMS 12.0 Support End-of-Life (EOL)
AT-GS900M Series	AT-GS908M AT-GS916M AT-GS924M	
AT-FS900M Series	AT-FS909M AT-FS917M AT-FS926M	
AT-MC2700	AT-MC2700	
Extreme BD 8810	Extreme BD 8810	
Extreme BD 8806	Extreme BD 8806	

TABLE 1-4 Devices Supported by NMS - Network Inventory, IP Maps, Alarms (Continued)

Family	Devices	Notes
Extreme Summit X250e	X250e-24t X250e-24p X250e-24x X250e-48t X250e-48p X250e-24tDC X250e-24xDC X250e-48tDC	
Extreme Summit X450a	X450a-24t X450a-48t X450a-24tDC X450a-24xDC X450a-24x X450a-48tDC	
Juniper SSG-550M	SSG 550M	
NetScreen	NS-208	
	NS-50	
	NS-5XT	
A10 AX3200	A100-AX3200	

1.6.3 iMG/RG Types Supported (3-8-03 and 4-n)

1.6.3.1 iMG/RG Device Support (up to 3-8-03)

Table 1-5 lists a history of iMG/RG devices, and includes those that support 3-8-03.

Note: This table lists all of the iMG/RGs that can be upgraded to 3-7 (using the Migration tool) and then which of those devices can be upgraded to 3-8. Also, note that there are some devices (such as RG623-BD) that have a release of 2-5 or 3-5 that are not being migrated to 3-7. These devices are at End of Life (EOL) but can still be supported by Release 12 of NMS.

TABLE 1-5 History of iMG/RG Releases Through 3-8-03

Device ¹	Previous	3-7 ²	3-8-01	3-8-02	3-8-03	Notes
RG613-BD/LH	2-5	Yes	Yes	Yes	Yes	
RG613-SH/TX	2-5	Yes	-	-	-	
iMG613-RF	2-5	Yes	Yes	Yes	Yes	Use RG613 in Boot Configurator
RG656-BD	2-5	Yes	Yes	Yes	Yes	
RG656-LH/SH/TX	2-5	Yes	-	-	-	
iMG606-BD	2-5	Yes	Yes	Yes	Yes	
iMG606-BD-R2		No	No	Yes	Yes	For 3-8-02
iMG606-LH/SH	2-5	Yes	-	-	-	
iMG646-BD	2-5	Yes	Yes	Yes	Yes	
iMG646-LH/SH	2-5	Yes	-	-	-	
iMG646-BD-ON/PX-ON	2-5	Yes	Yes	Yes	Yes	
iMG616-BD/LH/SH	3-5	Yes	Yes	Yes	Yes	
iMG616-BD-R2		No	No	Yes	Yes	For 3-8-02
iMG616-RF/RF+/SRF+	3-5	Yes	Yes	Yes	Yes	
iMG616-W	-	Yes	Yes	Yes	Yes	
iMG626-MOD	3-6	Yes	Yes	Yes	Yes	
iMG646-MOD	3-6	Yes	Yes	Yes	Yes	
iMG726-MOD	3-6	Yes	Yes	Yes	Yes	
iMG746-MOD	3-6	Yes	Yes	Yes	Yes	
iMG726BD-ON ³		No	No	Yes	Yes	For 3-8-02
iMG624-A	3-5	Yes	Yes	Yes	Yes	
iMG634-A	3-5	Yes	Yes	Yes	Yes	
iMG624-B	3-5	Yes	-	-	-	
iMG634-B	3-5	Yes	-	-	-	
iMG634-WA	3-5	Yes	-	-	-	
iMG634-WB	3-5	Yes	-	-	-	
iMG624-A-R2	-	Yes	Yes	Yes	Yes	
iMG634-A-R2	-	Yes	Yes	Yes	Yes	
iMG634-B-R2	-	Yes	Yes	Yes	Yes	
iMG634-WA-R2	-	Yes	Yes	Yes	Yes	

TABLE 1-5 History of iMG/RG Releases Through 3-8-03 (Continued)

Device ¹	Previous	3-7 ²	3-8-01	3-8-02	3-8-03	Notes
iMG634-WB-R2	-	Yes	Yes	Yes	Yes	
iBG915-FX	3-6	Yes	Yes	Yes	Yes	

1. Refer to 7.17 for functional groupings of iMGs/RGs.
2. With the Migration Tool, allows the offline migration of 2-5 im.conf to 3-7 format.
3. iMG726BD-ON has same processor and feature support with LAN and BD interfaces (no optional modules).

1.6.3.2 iMG2500 and 1500 Series

These devices are explained in the *Software Reference Manual* for the Allied Telesis Gateway Product Family for release 4.1.2

TABLE 1-6 History of iMG/RG Releases for 4.n Release

Device	First Release	Notes
iMG1505	4.0	
iMG1525	4.1	
iMG1525RF	4.1.1	
iMG2522	4.1.2	
iMG2504	4.0	
iMG2524	4.1	
iMG2524F	4.1.1	Supports 100M/1000 on the WAN interface
iMG1405, iMG1425	4.2.1	
iMG2524H	4.2.1	Has HPNA port

1.6.3.3 Comtrend Device Support (Comtrend NexusLink CT-5631)

Basic provisioning tasks are performed via the NMS Triple-Play Provisioning for ADSL. (There is also a TR-069 Browser.). Support is for Comtrend loads 310.9.1 and above. Refer to 5.7.6.

1.7 Levels of Support

1.7.1 Overview

The level and types of support depend on the product type, the specific product, and the feature support for a release.

1.7.2 Allied Telesis, AlliedWare, and AlliedWare Plus Products

Table 1-7 lists the support features for the AlliedView NMS with the Allied Telesis, Rapier, and Switchblade series products and what is supported for each product. Each table cell can have the following:

- **Y(es)**: NMS supports the feature in this release.
- **N(o)**: NMS does not support the feature in this release.
- **-**: The feature is not applicable for this device.

For the **Provision** feature group, if a product supports all the features, there is All in the first row

TABLE 1-7 Product Support Features for the AlliedView NMS in 14.0

Support Features	iMAP 9000 ¹	T-1000	Rapier Family ²	SB/9800 Family ³	x900 Family ^{4 5}	x600 ⁶	x610 ⁷	SBx3112
View Chassis	Y	--	Y	Y	Y ⁸	Y	Y	Y
Device Log Management	Y	Y	Y	Y	Y	Y	Y	Y
Backup/Restore	Y	N	Y	Y	Y	Y	Y	Y
Command Script Mgmt.	Y	-	Y	Y	Y	Y	Y	Y
Configuration File Mgmt	Y	-	Y	Y	Y	Y	Y	Y
Syslog Management	Y	N	Y	Y	Y	Y	Y	Y
SNMPv2 Configuration	Y	Y	Y	Y	Y	Y	Y	Y
SNMPv3 Configuration	N	-	Y	Y	Y	Y	Y	N
Software Configuration	Y	-	Y	Y	Y	Y	Y	Y
VLAN Configuration	Y	-	Y	Y	Y	Y	Y	Y
Card, Port Management	Y	-	Y ⁹	Y(9.)	Y(9.)	Y(9.)	Y(9.)	Y
Alarms/Events	Y	Y	Y	Y	Y	Y	Y	Y ¹⁰
Performance Monitoring	Y	Y	Y	Y	Y	Y	Y	Y
Telnet to Device	Y	Y	Y	Y	Y	Y	Y	Y
SSH	Y	-	Y	Y	Y ¹¹	Y(11.)	Y(11.)	Y ¹²
Stacking	-	-	-	-	Y	Y	Y	-
Browse Device	-	-	Y ¹³	Y	Y	Y	Y	-
Custom Load	Y	-	Y	Y	Y	Y	Y	Y
Text File Comparison ¹⁴	N	-	Y	Y	Y	Y	Y	Y
WebGen Service	-	-	Y	Y	-	-	-	-
Network Services								
- Link Operations	Y	-	Y	Y	Y	Y	Y	Y
- VLAN	Y	Y	Y	Y	Y	Y	Y	Y
- Profile mgmt.	Y	-	Y ¹⁵	Y	Y	Y	Y	Y
- QoS	Y	-	Y	Y	Y	Y	Y	Y
- EPSR/ESPR+	Y	-	Y ¹⁶	Y(16.)	Y	Y	Y	Y
- CES	Y	-	-	-	-	-	-	-
LLDP Configuration	Y	-	Y	-	Y	Y	Y	Y
LAG	Y	-	Y ¹⁷	N	Y	Y	Y	Y
VCS Monitoring	N		N	N	Y	Y	Y	N

1. Includes the iMAP 9100 series, released in 7.0, as well as the iMAP 9810, released in iMAP release 15.0.
2. Includes the 8700/8800/8900/9900/8600, Rapier Series (Rapeier24, Rapier48W, etc.), and x900 Series (x900-24x, x900-48F)
3. Includes the AT-9800, SB4004, and SB4008
4. Includes the x900-24XS, x900-24XT-n, x900-12XT/S, and x908.
5. Uses AlliedWare Plus firmware.
6. Includes the x600-24Ts, x600-24Ts-POE, x600-24Ts-POE+, x600-24Ts/XP, x600-48Ts, x600-48Ts/XP

7. Includes the x610-24SPs/X, x610-24Ts, x610-24Ts-PoE+, x610-24Ts/X, x610-24Ts/X-PoE+, x610-48Ts, x610-48Ts-PoE+, x610-48Ts/X, x610-48Ts/X-PoE+
8. For x900 stacked and SBx908 stacked, the chassis view shows both ETH0 ports as green, although only one should be green (the stack member with the connected eth0 port).
9. Card Management not supported. The device has no available card/slot.
10. When the SBx3112 is running R15.1, no alarm will be generated when wrong type of SFP module is inserted on XE6SFP card. This alarm will be supported in R16.0 device management software.
11. For AlliedWare Plus devices, only SSH version 2 is supported.
12. Cannot be used for Triple-Play Provisioning.
13. For the 8900, Not Applicable
14. For text files only, so backup files for iMAP devices are not supported.
15. For Profile Management and QoS, supported only in Release 2.5.1 and above.
16. EPSR+ is not supported.
17. Only AT-8600 is supported.

1.7.3 AR, AT, and GenBand Products

TABLE 1-8 Product Support Features for the AlliedView NMS in 14.0

Support Features	AR 700 ¹	AR 400	AR 400s ²	AT-8324	AT-8xxx ³	AT-85xx ⁴	AT-9700 ⁵	AT-8000S ⁶	AT-8000GS ⁷	AT-8100S ⁸	AT-9000 ⁹	G6/G2
Full Support	N			Y	Y	N	N	N	N	Y	N	N
View Chassis	Y			Y	Y	Y	Y	Y	Y	Y ¹⁰	Y ¹¹	N
Provision												
- Backup/Restore	Y	Y	Y	N	N	N	N	Y	N	Y	Y	Y
- Command Script Mgmt.	Y	Y	Y	N	N	N	N	N	N	N	N	N
- Configuration File Mgmt	Y	Y	Y	N	N	N	N	Y	N	Y	Y	N
- Device Information	Y	Y	Y	Y	Y	Y	Y	Y	Y	Y	Y	Y
- Device Log Management	Y	Y	Y	N	N	N	N	N	N	Y	Y	N
- SNMP Agent	Y	Y	Y	N	N	Y	Y	Y	Y	Y	Y	N
- SNMPV2 Configuration	Y	Y	Y	Y	Y	Y	Y	Y	Y	Y	Y	N
- SNMPV3 Configuration	Y	Y	Y	N	N	Y	Y	Y	Y	Y	Y	N
- Software Configuration	Y	Y	Y	N	N	N	N	Y	N	Y	Y ¹²	N
- Text File Comparison	Y	Y	Y	-	-	N	Y	Y	N	N	Y	N
- Configure VLAN	-	Y	Y	Y	Y	N	N	Y	Y	Y	Y	N
- Card, Port Management	-	-	-	-	-	-	-	-	Y	Y ^{13 14}	Y ^(13.)	N
- Syslog	Y	N	N	N	N	N	N	Y	N	Y ¹⁵	Y ¹⁶	N
- SSH	Y	Y	Y	N	N	Y	Y	Y	Y	Y ¹⁷	Y	N
WebGen Service	Y	-	-	-	-	-	-	-	-	-	-	-
Network Service												
- Link Operations	-	Y	Y	Y	Y	N	N	Y	Y	Y	Y	N
- VLAN	-	-	-	All	All	N	N	Y	Y	Y	All	N
- Profile Mgmt.	-	Y	Y	N	N	N	N	N	N	N	N ¹⁸	N
- QoS	-	Y	Y	N	N	N	N	N	N	N	N	N
- EPSR	-	-	-	N	N	N	-	-	N	N	N	N

TABLE 1-8 Product Support Features for the AlliedView NMS in 14.0

Support Features	AR 700 ¹	AR 400	AR 400s ²	AT-8324	AT-8xxx ³	AT-85xx ⁴	AT-9700 ⁵	AT-8000S ⁶	AT-8000GS ⁷	AT-8100S ⁸	AT-9000 ⁹	G6/G2
- CES	-	-	-	-	-	N	-	-	-	-	-	N
LLDP Configuration	N	N	N	N	N	Y	N	Y	Y	N	N	N
LAG ¹⁹	N	-	-	-	-	Y		Y	Y	N	N	N
VCS Monitoring	N	-	-	-	-	Y		Y	Y	Y	N	N
Alarms/Events	Y	Y	Y	Y	Y	Y	Y	Y	Y	Y ²⁰	Y(20.)	N
Performance	Y	Y	Y	Y	Y	Y	Y	Y	Y	Y	Y	N
Browse Device	Y	Y	Y	Y	Y	Y	Y	Y	Y	Y	Y	N
Rediscover Device	Y	Y	Y	Y	Y	Y	Y	Y	Y	Y	Y	Y

1. Includes the AT-AR720, AT-AR725, AT-AR740, AT-AR745, AT-AR750s, and AT-AR770s
2. Includes the AT-AR415S, AT-AR440s, AT-AR442S
3. Includes the AT-8012, AT-8016F, AT-8024, AT-8026, AT-8088
4. Includes the AT-8516F/SC, AT-8524M, AT-8524POE, AT-GB, AT-8550SP
5. Includes the AT-9724, AT-9748
6. Includes the AT-8000S/16, AT-8000S/24, AT-8000S/24POE, AT-8000S/48, AT-8000S/48POE
7. Includes the AT-8000GS/24, AT-8000GS/24POE, AT-8000GS/48
8. Includes the AT-8100S/24C, AT-8100S/24, AT-8100S/24POE, AT-8100S/48, AT-8100S/48POE
9. Includes the 9000/28, 9000/28SP, 9000/52
10. If the devices are in stacked configuration and a SFP module is inserted to the stack member 2; the CLI command 'show system pluggable' will not show SFP modules for stack members. If the device stack ID is not 0, Chassis View and Port Management shows all ports are down. This is due to doing the SNMP GET of the ifOperStatus <portinterface> returns the value '2', which means down. Finally, the incorrect LED turns green when an SFP module is inserted in the SFP port and its corresponding redundant RJ-45 port is active.
11. Incorrect LED turns green when an SFP module is inserted in the SFP port and its corresponding redundant RJ-45 port is active.
12. Software Configuration is supported. However, this feature is not yet supported in NMS 12.2.1.
13. Provision/De-provision button under Port Management is disabled since Profile Management function will not be supported.
14. If the device stack ID is not 0, Chassis View and Port Management shows all ports are down. This is due to doing the SNMP GET of the ifOperStatus <portinterface> returns the value '2', which means down
15. Supported, but unable to set Device Logs to disable. Moreover, syslog status cannot be disabled. Refer to Release Notes.
16. Syslog status on AT9000 cannot be disabled.
17. Open SSH prompts for the password twice.
18. Provision/De-provision button under Port Management is disabled since Profile Management function is not yet supported.
19. To display the LAG configuration on the Physical Network Map during discovery, LLDP must be enabled.
20. No alarm is generated after a cold or warm restart.

1.7.4 Specific Market Devices

Table 1-9 and Table 1-10 list the support features for the AlliedView NMS for other products.

Note: Contact your Allied Telesis Customer Representative for detailed information on using these devices, since many of them fulfill specific market requirements.

TABLE 1-9 Product Support Features for the AlliedView NMS in 14.0

Support Features	Juniper ¹	Extreme Summit ²	Extreme BD ³	Netscreen 208
Full Support	-	-	-	-
View Chassis	-	-	-	-
Provision	-	-	-	-
- Backup/Restore	Y	Y ⁴	Y (4.)	-
- Command Script Mgmt.	-	-	-	-
- Configuration File Mgmt	-	-	-	-
- Device Information	-	-	-	-
- Device Log Management	-	-	-	-
- SNMP Agent	-	-	-	-
- SNMPV2 Configuration	Y	Y	Y	N
- SNMPV3 Configuration	Y	Y	Y	N
- Software Configuration	-	-	-	-
- Text File Comparison	-	-	-	-
- Configure VLAN	-	-	-	-
- Card, Port Management	-	-	-	-
- Syslog	-	-	-	-
- SSH	N	Y	Y	Y
WebGen Service	-	-	-	-
Network Services	-	-	-	-
- Link Operations	-	-	-	-
- VLAN	-	-	-	-
- Profile Mgmt	-	-	-	-
- QoS	-	-	-	-
- EPSR	-	-	-	-
- CES	-	-	-	-
LLDP Configuration	-	-	-	-
LAG	-	-	-	-
VCS Monitoring	-	-	-	-
Alarms/Events	-	-	-	-
Performance	-	-	-	-
Browse Device	-	-	-	-
Rediscover Device	-	-	-	-

1. Includes the SSG-55M

2. Includes the X250e-24t and X450a-24t
3. Includes the BD 8810 and BD8806
4. For Extreme devices, there is the option to specific additional files for backup.

TABLE 1-10 Product Support Features for the AlliedView NMS in 14.0

Support Features	CentreCom AR Series ¹	CentreCom 8000 series ²	CentreCom MC2600	CentreCom MC2700	CentreCom 9400 Series ³	GS Series ⁴	FS Series ⁵	CentreCom 9048XL
Full Support								
View Chassis	Y	Y	Y ^{6 7}	Y ^{8 9}	Y	Y	Y	Y
Provision								
- Backup/Restore	Y	Y	Y	Y	Y	Y	Y	Y
- Command Script Mgmt.	Y	N	-	-	-	N	N	N
- Configuration File Mgmt	Y	Y	Y	Y	Y	Y	Y	Y
- Device Information	Y	Y	Y	Y	Y	Y	Y	Y
- Device Log Management	Y	Y	Y	Y	Y	Y	Y	Y
- SNMP Agent	Y	Y	Y ¹⁰	Y ¹¹	Y ¹²	Y	Y	Y
- SNMPV2 Configuration	Y	Y	Y	Y	Y	Y	Y	Y
- SNMPV3 Configuration	Y	Y ¹³	-	-	Y	-	N	-
- Software Configuration	Y	Y	Y	Y	Y ^{14 15}	Y	Y	Y
- Text File Comparison	Y	Y	Y	Y	Y	Y	Y	Y
- Configure VLAN	Y	Y	-	-	Y	Y	Y	Y
- Card, Port Management	Y ¹⁶	Y (16.)	-	-	Y (16.)	N	N	N
- Syslog	Y	Y	Y ¹⁷	Y(17.)	Y(17.)	Y	Y(17.)	Y(17.)
- SSH	Y	N ¹⁸	-	-	Y	-	-	-
WebGen Service	N ¹⁹	N (19.)	-	-	Y	-	-	-
Network Services								
- Link Operations	Y	Y	-	-	Y	Y	Y	Y
- VLAN	Y	Y	-	-	Y	Y	Y	Y
- Profile Mgmt	N	N	-	-	N	N	N	N
- QoS	N	N	-	-	N	N	N	N
- EPSR	N	Y	-	-	Y ²⁰	Y	Y ^{21, 22}	Y
- CES	N	Y	-	-	-	N	N	N
LLDP Configuration	Y ²³	23. and ²⁴	-	-	-	N	N	N
Alarms/Events	Y	Y	Y	Y	Y ²⁵	Y	Y	Y
Performance	Y	Y	Y	Y	Y	Y	Y	Y
Browse Device	Y	N	Y	Y	-	Y	Y	Y
Rediscover Device	Y	Y	Y	Y	Y	Y	Y	Y

1. Includes the AR415S, AR550S, AR570S, AR560
2. Includes the 8748XL, 8724SL, 8724SL V2/8748SL, 8424TX/8424XL, 8316XL/8324XL
3. Includes the 9424T and 9424/SP

4. Includes the GS924M, GS916M, GS908M, GS924M v2, GS916M v2, GS908M v2
5. Includes the FS808M, FS926M, FS917M, FS909M, FS909M-PS and FS917M-PS.
6. There is no info via SNMP or CLI that shows the duplex mode. The duplex led will always be gray.
7. The color of disabled port will not turn orange when module/port is disabled via CLI
8. There is no info via SNMP or CLI that shows the duplex mode. The duplex led will always be gray.
9. The color of disabled port will not turn orange when module/port is disabled via CLI
10. Can only have a maximum of two SNMP communities
11. Can only have a maximum of two SNMP communities
12. Disregard the SNMP Version parameter when creating and modifying SNMP Community
13. 8748XL is not supported.
14. NMS will return the Application Software Version name which was shown when commands 'show switch' and 'show system' was executed on the device instead of the exact filename of the loaded release file.
15. Manage WebGen Passwords function is not supported.
16. Support for Port Management, Card Management is not applicable.
17. Enable and Disable of Device Log(s) are the only supported operations; only the default syslog server and filter are available.
18. Only the 8748XL supports SSH.
19. For CentreCom devices, license management is incorporated when downloading firmware in Software Configuration
20. "Create/Protect EPS Data Ring", "View EPS Data Protection" and "Modify Protection Domain" are not supported
21. FS808 devices do not support EPSR
22. When creating EPSR, ports should not be part of STP.
23. LLDP configuration per port is not supported.
24. Only 8700 devices support LLDP configuration module.
25. There will be no event generated for 'authenticationFailure' trap when using SNMPv3. It is only applicable when using SNMPv1 or SNMPv2c.

1.7.5 Devices Supported by SwimView

Table 1-11 lists the devices that are discovered and viewed/modified by SwimView.

Note: Contact your Allied Telesis Customer Representative for detailed information on using these devices with SwimView, since many of them fulfill specific market requirements.

TABLE 1-11 Devices Supported by SwimView

Device	Device	Device	Notes
AT-SB4104-00	8216XL	AR130	
AT-SB4108-76	8216FXL/SC	MBRK16-10	
9924T/4SP	8216FXL/SMSC	MBRK16-80	
9924Ts	8124XL	MBMC115B	
9924SP	8124	LBMC115A	
9816GB	8116	MBMC140B	
9812T	8016XL	LBMC140A	
9606SX/SC	8008	MC2700-10	
9606T	3734TX	MC2602	
9108	3734TX-1F	MC2601	
8948XL	8216XL2	WD1008L	
8748XL	8216XL2/SMSC	WD1004	
8724XL	3726XL	WD1002	
8748SL	3726	WD1001	
8624XL	3716TR plus	AT-1331-10/80	
8624PS	3716TR	RG107TX	
8624EL	RG107TX/B	RG203TX-SIP/H323	
8550	FS816M	RG203TX V2-SIP/H323	
8525	GS908M V2-4PS	VS812TX	
8518	9048XL	VS503EX	
8312	IA810M	AT-TQ2403	
9424T	AR740	AT-TQ2450	
9424T/SP-E	AR720	RH609	
9424Ts/XP-E	ARX640S	FH812u	
9424T/SP	AR450S	FH824u	
9408LC/SP	AR415S	FH612TX	
9006SX/SC	AR410 V2	FH612TXS	
9006T	AR320	3600 series	
8424XL	AR300 V2	AT-TS HUB Series	
8424TX	AR300L V2	SBx3112	
8324XL	AR300	8724SL	
8316XL	AR300L	AR160	
8224XL	AR260S V2	8748SL V2	
8224SL	AR260S	9048X / 9048XL	

1.8 Document Conventions

To help the reader use this document, the following conventions are used:

- Menu selections are in bold/italic, with -> for accessing a submenu, such as ***Policy*** -> ***Add Policy***.
- Descriptions of properties are in a two-column table, with the order of properties matching the order of policies matching those shown on the window.
- Names of windows and window elements (such as Tool Tips) are in bold, such as the **Restore Configuration** window.
- Admonishments use the words Note, Caution, and Warning, where note means added information, Caution means a potential degradation of service, and Warning means a potential loss of service/revenue.

1.9 How to Use Supporting Documents

1.9.1 Document Media

Customer documentation is offered on the Allied Telesis website, with the option to download all available releases.

1.9.2 Printing Hardcopy

Hardcopy of the documents is in pdf format and requires Acrobat Reader. The link to the Acrobat site is provided on the NMS document web site.

1.9.3 Accessing Online

The pdf documents are also used for context-sensitive online help.

1.9.4 Using Online Help with NMS

In the main screens of NMS and various forms, there is a Help or question mark button. When the user presses this button, the relevant section of the NMS User or Administration Guide will appear.

1.10 Copyrights

This product contains copyright material licensed from AdventNet, In <http://www.adventnet.com>. All rights to such copyright material rest with AdventNet.

2. Installing and Starting Up

2.1 Overview

The AlliedView NMS software is delivered as a CD-ROM, which includes both server and client (application interface) software.

2.2 AlliedView NMS Installation

Refer to the AlliedView NMS Installation Guide for the system requirements, limitations, and the installation and startup procedures.

Note: The monitor used with the client and server machines should have a resolution of 1280x1024 or better.

2.3 Starting up AlliedView NMS

Refer to the AlliedView NMS Installation Guide for steps on starting up the AlliedView NMS server and client on Windows and Solaris platforms.

2.3.1 Password Configuration

The NMS provides the option to configure your password once you have logged into the application client or the browser client for the first time. The **Password Configuration** dialog box appears by choosing the **Tools -> Change Password** menu item. Refer to the following figure. You can type in your new password and set the time duration for which this password is to remain valid. Refer to the following figure.

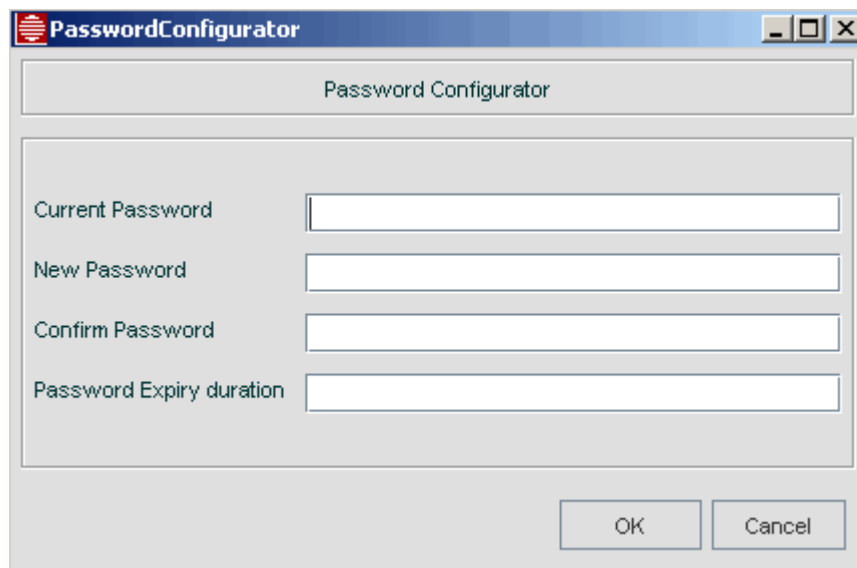

FIGURE 2-1 Setting a New Password

If at anytime you wish to change the password, select *Tools -> Change Password* from the main menu bar, and the **Password Configurator** form will reappear.

2.3.2 Configuration Limits for Clients

The AlliedView NMS server can support up to five GUI client connections at the same time.

Note: Connecting to the AlliedView NMS server using an html client counts as one of the five allowed users.

2.4 Using the Logs Console

When the client is first started, the user has the option of having a console file open during the session with AlliedView NMS. The console file tracks all events that occur between the client and server for the life of the session.

The following figure is an example of the console file when the client first starts and includes general information about the AlliedView NMS configuration. Messages are grouped with a header for each day.

At any time during a session, the contents can be written to a file (**Save to File**) for archiving and for saving for Allied Telesis technical support.

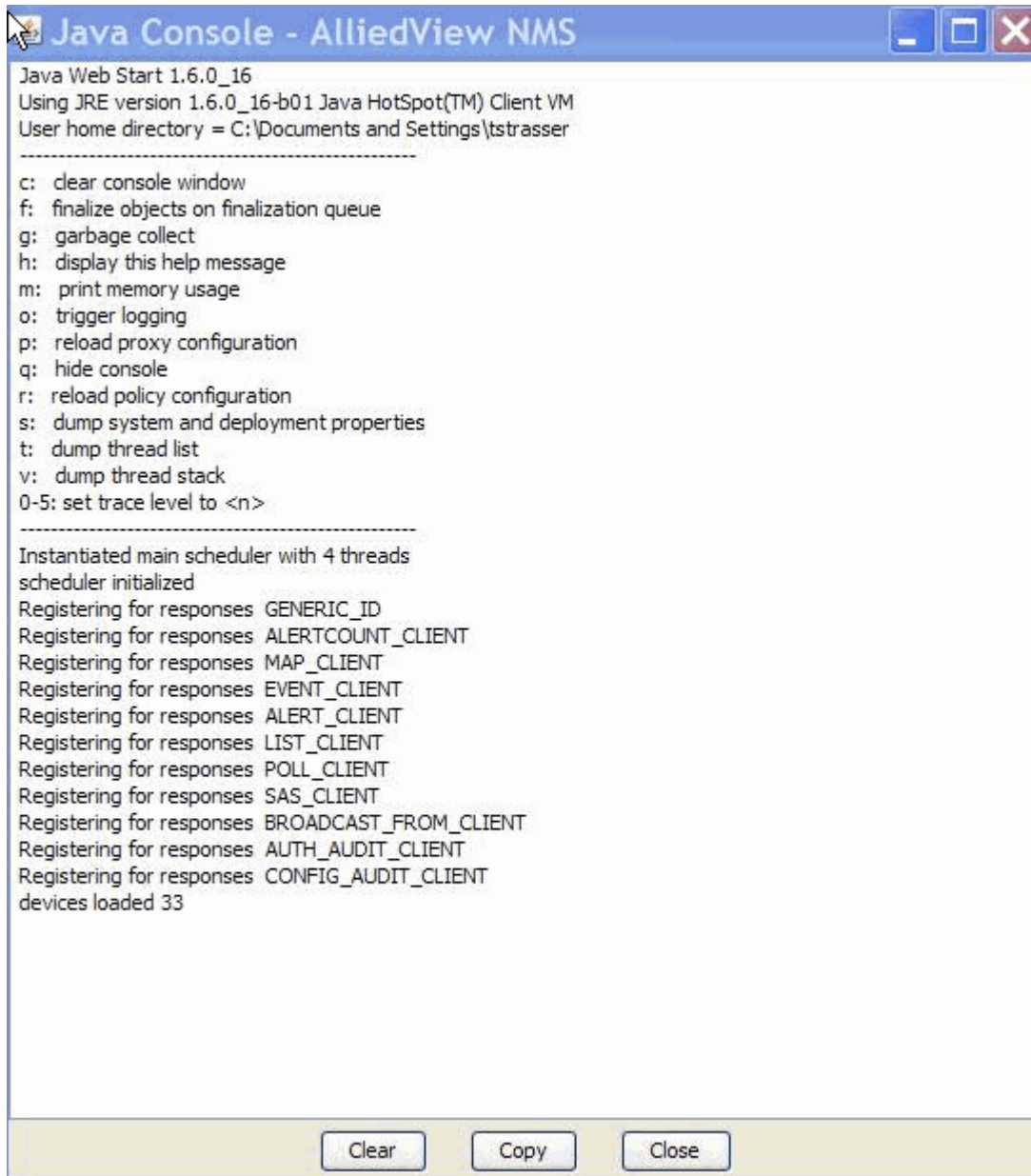

FIGURE 2-2 Console File Window

2.5 The Application Screen

When you log in to the Application interface, the default screen that is displayed shows a map containing the map symbols that represent the discovered network devices. Refer to the following figure. You can find the common Menu Bar, Toolbar, Map Toolbar, AlliedView NMS Client Tree, Alarm Count Panel, Status Bar, and the AlliedView NMS Panel displayed in the user interface.

An overview of the look and feel of the Application Screen is provided in the *AlliedView NMS User Guide*.

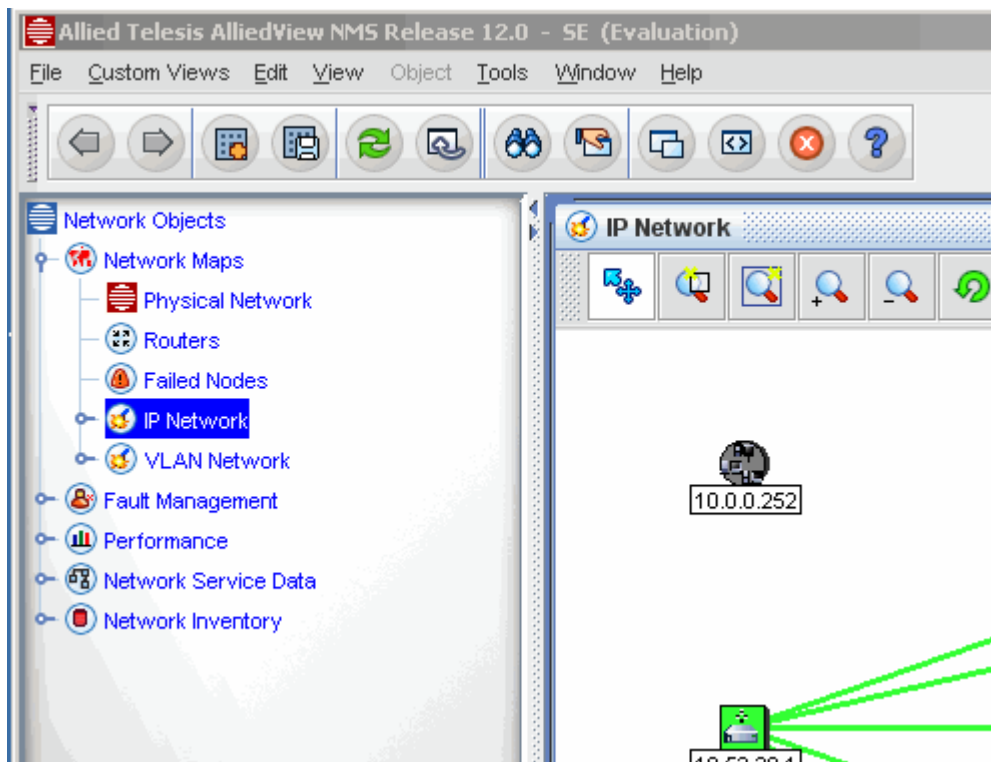

FIGURE 2-3 Initial Network Interface

2.6 Broadcasting a Message

The option *File -> Broadcast Message* can be used to send messages to all the clients. When this option is selected, the message is sent to all the clients managed by the main AlliedView NMS Server by default. (The option chosen does not matter.) When this option is selected, a dialog that contains the following details pops up. Refer to the following figure.

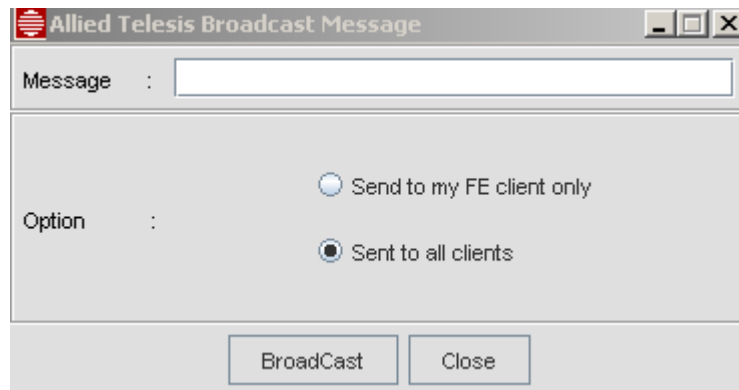

FIGURE 2-4 Broadcasting a Message (use bottom option only)

The following table lists the properties for broadcasting a message.

TABLE 2-1 Properties for Broadcasting a Message

Property	Details for Broadcast Message Properties
Message	The message to be broadcast.
Option	Two message options. The option Send to my FE client only is not supported. The other option is Send to all clients . When this option is selected, the message is sent to all the clients that are managed by the main AlliedView NMS Back-End Server.
BroadCast	Sends the message. The message sent is displayed in the status bar of the receiver.

2.7 Restart / Shut Down the Server

The procedures in this Guide that involve changes made to the server and its files do not need a server restart to take effect. You should restart the server only if a procedure instructs you to do so.

Warning: *The administrator should avoid restarting the server, since during restart the AlliedView NMS is no longer monitoring devices and cannot communicate with any clients.*

2.8 Resource Management

2.8.1 Setting the Custom Security Policy (Required)

This must be set for the server.

- Find the java runtime environment (jre). It's usually located in:
`<drive>:/Program Files/Java/jre*`
or use the Control Panel Java Plug-in tool "Advanced" tab to see the exact path of the java runtime.
- Open the `java.policy` file in `lib/security` (under the jre path).
- Append a tag for the NMS server in the system, as follows, where `<server_name>` is a host name or IP address:

```
grant {  
    permission java.net.SocketPermission "<server_name>", "accept,connect,resolve";  
    permission java.awt.AWTPermission "setAppletStub";  
};
```

- Save the file.

Wildcard (*) can be used in the `server_name` but the wildcard must be the first character, such as `*.sun.com`.

You can combine the NMS-specific permissions for the server into a single grant, as follows:

```
grant {  
    permission java.net.SocketPermission "nmstest2", "accept,connect,resolve";  
    permission java.awt.AWTPermission "setAppletStub";  
};
```

`nmstest2` is an example server.

Note: Permissions are also required when using the WebGen features. Refer to [4.7.2](#) and [5.3.9.5](#).

2.8.2 Resource Management Table (Tools -> Resource Management)

To view the status of the server configuration, the user selects **Tools -> Resource Management** from the main menu. The Resource Management Window appears, as shown in the following figure.

Note: This table should only be used by the Administrator.

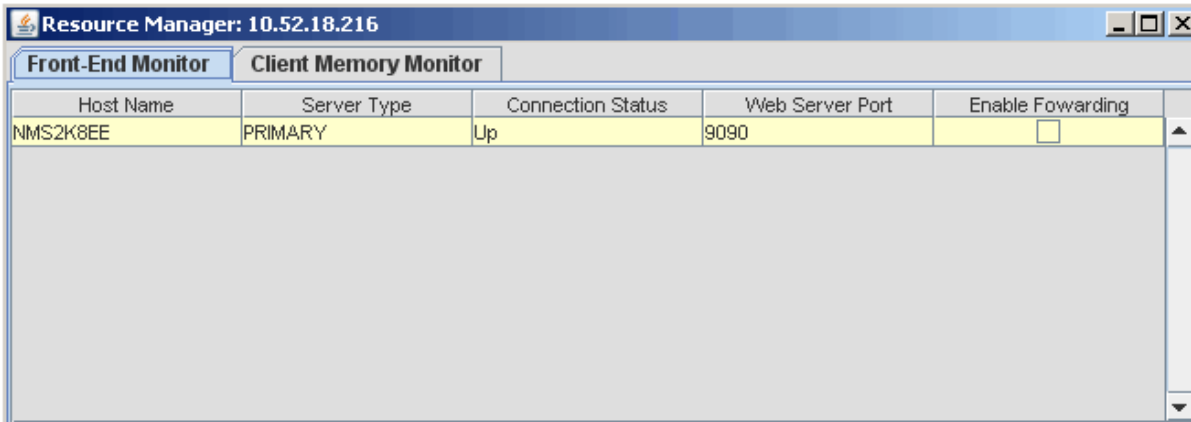

Host Name	Server Type	Connection Status	Web Server Port	Enable Forwarding
NMS2K8EE	PRIMARY	Up	9090	<input type="checkbox"/>

FIGURE 2-5 Resource Manager Window - Back End Only

2.8.3 Front-End Monitor

Note: This applies to the distributed FE system available prior to 11.0.

In the example above, there is the default client to BE configuration. This has the following information:

- Resource Manager (in window title) - This is the server the client currently is connected to. (If the client is locally connected to the server this will be localhost.)
- HostName - These are the servers currently deployed in the AlliedView NMS server configuration. In the default BE only configuration, there is only one server and therefore only one row.
- Server Type - The BE server will have PRIMARY as the server type, while the FE servers will have STANDALONE.
- Connection Status - Working connections are Up. If a server fails this will change to Down.
- Web Server Port - This is the port used by the client to connect to the server.
- Enable Forwarding - This box is editable only when there is more than one server, and can only be activated for the FE server when the client is connected to that FE server. The feature is explained above.

2.8.4 Client Memory Monitor

This tab brings up a graph that monitors the memory used on the client. Memory allocated is the java heap space pre-allocated at start-up, while the used memory is the actual memory used by the client. If the client is functioning slowly, this graph can help determine if client memory usage is an issue. Refer to the following figure.

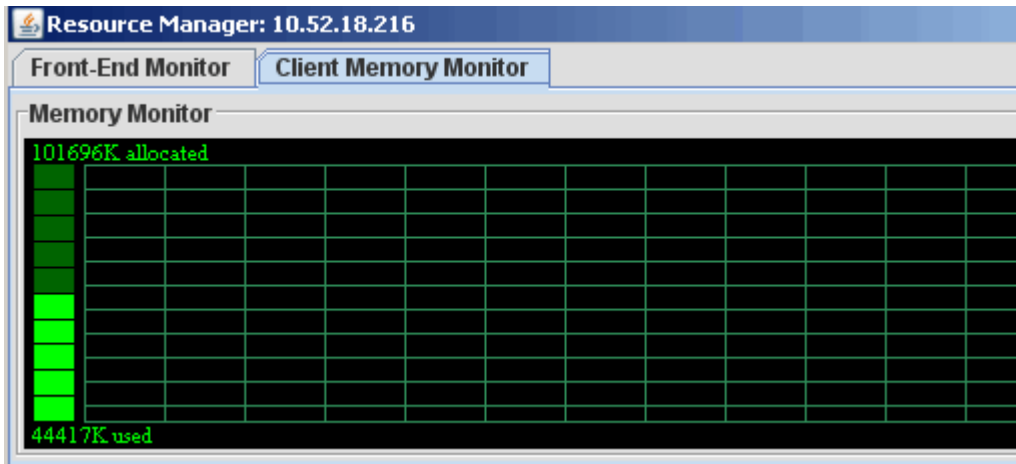

FIGURE 2-6 Client Memory Monitor

3. File Administration

3.1 Overview

Many administrative tasks for the AlliedView NMS are done by adding, changing, and deleting files on the server. However, directly accessing these files should not be attempted, since a loss of AlliedView NMS functionality could result.

For this reason, the AlliedView NMS provides GUI-based functions (mainly the Discovery Configurator) that make updating the AlliedView NMS files easy and less error-prone. Moreover, the server does not have to be restarted for the changes to take effect. However, a few tasks will involve restarting the server. These tasks are also included in this section, and the point at which a restart is required is highlighted.

Note: Throughout this section, <NMS_HOME> refers to the directory where the NMS was installed, with the default as:

- Windows - c:\Program Files\Allied Telesis\AlliedView NMS
- Solaris - /opt/AlliedTelesis/AlliedViewNMS

Directory names inside configuration files use the Internet standard of forward slashes (/), whether on Windows or Solaris.

Caution: *Table 3-1 only lists the tasks that are fully supported. Accessing a file on the server and changing a value without Allied Telesis Support could result in a loss of AlliedView NMS functionality.*

TABLE 3-1 Task List for File Administration

Task	Screen / Form Name (if Applicable)	Section
Discovery Configurator (SE)	Form with set of Tabs for SE version	3.2
	Schedule Tab	3.2.2
	SNMP Tab	3.2.3
	CWMP Tab	3.2.4
	CLI Logins Tab	3.2.5
	Network Discovery Tab	3.2.6
	Node Discovery Tab	3.2.7
	Other Discovery Tab	3.2.8
- Example		3.2.9
Discovery Configurator (EE)	Form with set of Tabs for EE version	3.3
	Basic Tab	3.3.2
	SNMP	3.3.3
	CWMP Tab	3.3.4
	CLI Logins Tab	3.3.5
	Network Discovery Tab	3.3.6
Node Discovery	3.3.7	

TABLE 3-1 Task List for File Administration (Continued)

Task	Screen / Form Name (if Applicable)	Section
AlliedView NMS Backup and Restore	AlliedView NMS Backup	(3.4.1)
	AlliedView NMS Restore	(3.4.4)
	Device Backup Limit	(3.4.5)
Node Limiting, Registering NMS load	AlliedView NMS License Manager	(3.5)
Software Downloads	Software Configuration (Modify Release Configuration, Create Custom Load buttons)	(3.6)
Monitor AlliedView NMS server/processes	Status Monitoring	(3.9)
Firmware Upload Tool	Load Import	(3.10)
Access database	NA	(3.11)

3.2 Discovery Configurator (Service Provider)

3.2.1 Overview

AlliedView NMS discovers devices in a network and then, based on the properties of the device, constructs ManagedObjects for each discovered device.

There are several ways to invoke the Discovery Configurator panel.

- For both windows and Solaris, Invoke the Discovery Configurator as a standalone tool by invoking file **DiscoveryConfigurator.bat** in the `<NMS_home>/bin/admintools` directory.
- With the NMS started and the a client interface, select **Tools ->Discovery Configurator (Alt + R)** from the main menu.
- For windows, begin with the menu Start menu and select Tools -> Discovery Configurator.

Note: There are differences when changes made will take effect. Refer to 3.2.9.1.

3.2.2 Schedule Tab

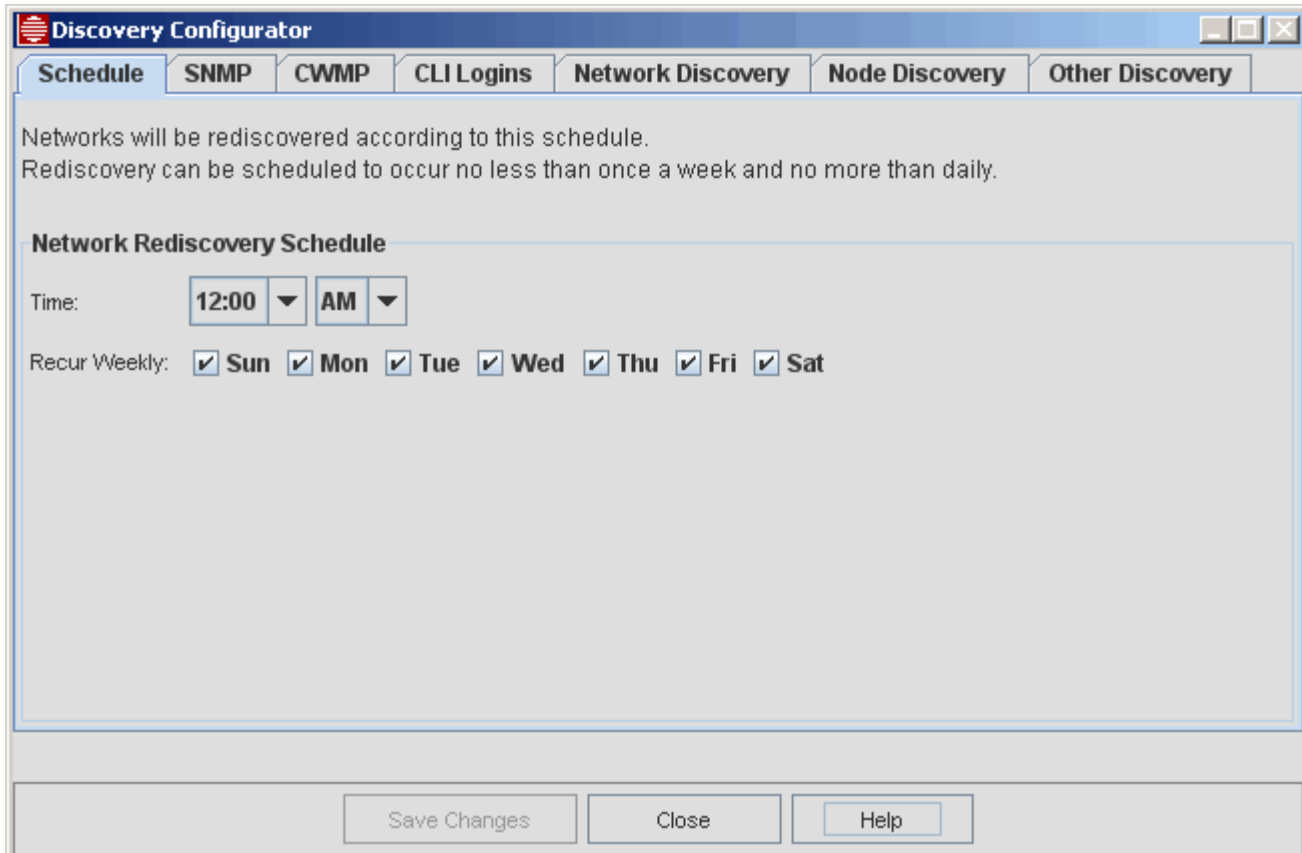

FIGURE 3-1 Discovery Configurator – Initial Screen (Schedule Tab)

The schedule tab allows configuring the rediscovery time, the time all managed devices in networks included for discovery in the Network Discovery tab will be rediscovered to update the NMS database with any changes, including the addition of new devices.

Note: Devices in the Node Discovery tab will not be rediscovered.

To schedule the time, choose an hour and select one or more days of the week. Nightly rediscovery is recommended. At least once a week is required, with no more than once every 24 hours.

The buttons are defined as follows, and have the same function for all tabs:

- **Save Changes** - Saves the configuration to the NMS database and leaves the dialog up.
- **Close** - Dismisses the dialog, but before doing so will prompt to save changes if changes are pending.

If a user makes a change in the Network Rediscovery Schedule, the NMS displays a popup that requires the user to select from two options. Refer to the following figure.

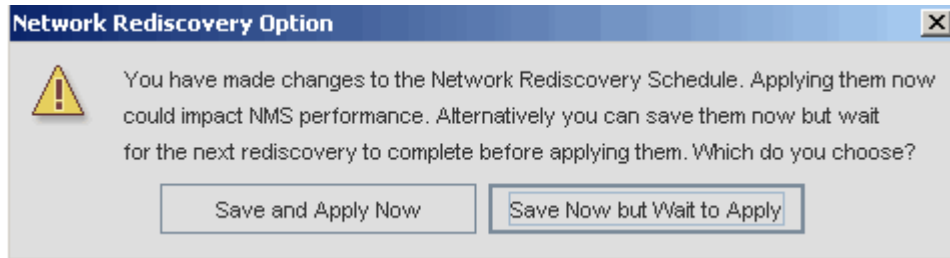

FIGURE 3-2

1. The "Save and Apply Now" option makes the schedule change immediately, but in doing this it will immediately restart discovery, which can slow down the NMS and disrupt operations.
2. The "Save Now but Wait to Apply" option also saves the new schedule but without disrupting operations, because the schedule changes won't go into effect until the next previously-schedule discovery completes. Note, however, that when adding a new network, the discovery for this new network will initiate immediately (since this network has not been previously discovered).

Option 1 can be used to force an immediate rediscovery or to move the schedule earlier in case it's currently scheduled too late. Option 2 is the default because that will normally be the desired case.

3.2.3 SNMP Tab

Discovery Configurator

Schedule **SNMP** CWMP CLI Logins Network Discovery Node Discovery Other Discovery

Devices will be discovered if they respond to one of the SNMP Read Communities in the list below.
For each IP address, communities will be tried in the order listed until one succeeds or they all fail.

Communities

Read Communities

- public
- notpublic
- tim
- tims

Write Communities

- private
- public
- friend
- eeeee

Read: public Write:

▲ ▼ Add Modify Delete ▲ ▼ Add Modify Delete

Parameters

Port(s): 161 Timeout: 2 Retries: 0

SNMP v3

Enable SNMPv3 Discovery Context Name:

User Names

User Name:

▲ ▼ Add Modify Delete

Save Changes Close Help

FIGURE 3-3 Discovery Configurator – SNMP Tab

Only devices that respond to SNMP can be discovered and managed by the AlliedView NMS. The NMS will perform “SNMP Ping” operations with each of the given read communities until a device responds or all communities have been tried and failed. (SNMP Pings are essentially SNMP get requests for selected system variables. Devices that respond are considered “connected” and those that don’t are considered “unreachable”)

3.2.3.1 SNMPv2

For most devices, only read communities are used during discovery. Some devices, including iMG/RGs, require discovering write communities as well.

Communities will be attempted in the order displayed. The order may be modified by selecting a row and then clicking on the up/down buttons.

Communities may be added, modified, or deleted with the **Add**, **Modify** or **Delete** Buttons. The Add button will add to the list whatever is in the Read or Write text field. The Modify button will replace whatever is in the selected row with whatever has been typed in the Read or Write text field.

The SNMP agent port, timeout, and retry count can be configured as well. The defaults are 161, 2, and 0 respectively. Whereas 161 is the most commonly used SNMP agent port, others can be added as a space-separated list. Each port will be tried in the given order.

3.2.3.2 SNMPv3

There is the option to enable SNMPv3 Discovery, which adds security and administration features. (For information on the relationships between the SNMP versions refer to RFC 3416.)

The SNMP panel allows the addition of Users following the User-based security model defined in RFC 3414. As RFC 3416 states, only those principals (users) having legitimate rights can access or modify the values of any MIB objects supported by that entity.

The SNMP panel includes the Enable SNMPv3 Discovery option, as shown in Figure 3-3. User Names are added by typing in the User Name field, the Context Field, and then selecting **Add**. Names can continue to be added and the order changed using the direction arrows. A name can be modified by selecting a name, changing the name in the User name field, and selecting **Modify**. Selecting **Save Changes** writes the values to the NMS.

3.2.4 CWMP Tab

The CWMP (Common WAN management Protocol) Discovery tab is added for TR-69 Support. This tab allows setting the ACS (Auto Configuration Server) login credentials on the NMS and creating a list TR-69 connection request login credentials for iMGs.

The ACS login credentials will be used by iMGs when they connect to the ACS embedded with the NMS server. iMGs can log into the ACS if they use any username/password from the ACS list.

During discovery, the NMS will discover the connection request login credentials by trying the username/password pairs in the CPE list, in configured order, until successfully logged in. The connection request login credentials will be used by the NMS to log into and contact iMG. Refer to the following figure.

FIGURE 3-4

The CWMP tab consists of 2 lists, one of ACS usernames and one of CPE usernames. Since order is significant, credentials in each list may be reordered by clicking the arrow buttons below each list until the desired order is attained.

There is a password associated with each username. Duplicates are allowed.

Note: Password displays are blotted. Some duplicates may be difficult to distinguish from others.

Credentials may be added with the Add button after typing in a new username and password below each list.

Credentials may be modified by selecting a row, modifying the values in the username and password fields and clicking the Modify button.

Credentials may be deleted by selecting one or more rows and clicking on the Delete button.

No change is saved permanently, until the Save Changes button is clicked.

3.2.5 CLI Logins Tab



The CLI Login Manager allows the user to specify a list of CLI username/password pairs that will be used by the Discovery Process to determine the CLI username and password for individual devices. The username and password discovered for each device are used for all CLI interactions with the device.

All managed devices are shipped with a factory-default CLI username and password, and customers are encouraged to change these for security reasons.

Caution: As mentioned in Section 1.6.3 there is a user name and password used to access the device, and this name/password is used by all NMS users when accessing a device. To enable NMS users to query and control a device, the device name and password must be at a security officer level. Failure to do so may make certain operations performed at the NMS on a device to fail.

Type	Protocol	User Id	Hints	Description
login	telnet	manager	Rapier, RG600	Factory default login for AR-XXX, AT-XXXX, IMG/RG, Rapier, and Switchblade devices
login	telnet	officer	Telesyn	Factory default login for iMAP Devices
login	telnet	admin	GenBand	Factory default login for GenBand
login	telnet	root	Comtrend	Factory default login for Comtrend devices
login	telnet	support	Comtrend	Factory support login for Comtrend devices
login	telnet	netscreen	Juniper	Factory default for Juniper devices
login	telnet	admin	Extreme	Factory default for Extreme devices
login	telnet	admin	A10 Networks	Factory default for A10 Networks devices
tacacs+	telnet	tacacs+		Default TACACS+ security officer passcode
login	telnet	tim		
login	telnet	dfsdf		

FIGURE 3-5 Discovery Configurator – CLI Logins Tab

Once a device has been discovered by SNMP, more detailed discovery requiring a CLI login is required to manage the device. The NMS attempts to log into each device until it either discovers an accepted login or all login attempts are rejected. The login sequence generally follows the order of the logins in the table. The order may be modified by selecting a row and then clicking on the up or down   buttons.

The login sequence can be overridden by the **Hints** field. Hints are a comma-separated list of device category, sysLocation, IP address, and subnets (in x.x.x.x/bits notation). Login parameters for a device that matches any of the hints will be attempted before any other login parameters. If there are more than 1 login entry with matching hints, they will be attempted in the sequence from the list.

The NMS will retry each user id up to 5 minutes if it gets connection-refused errors (in case it just came up and needs more time to finish initializing telnet and/or ssh services). If the NMS never gets connected, it will raise a discovery failure alarm.

If all login attempts with matching hints fail, all of the entries without hints will be attempted until one is accepted or all are rejected. And if all of those fail, all of the rest (without matching hints) will be attempted.

The Description field is a free format reminder of what each login entry represents.

There are 2 login types: User and Security Officer, which are specified by the radio buttons. The “user” type uses the User Id and Password to initially log into the device. User login is all that’s required for iMAPs running without TACPLUS.

If an iMAP is running with TACPLUS enabled, the NMS also needs a Security Officer passcode (to enable securityofficer). Security Officer passcodes can be designated by clicking on the Security Officer radio button. For Security Officer, the User Id field is not applicable and will be disabled and set to “tacacs+”. (You can still define a user login with the user id tacacs+, if necessary, by clicking on the User radio button instead of the Security Officer radio button) Security Officer passcodes will be attempted as ordered in the list and as overridden by Hints. Since multiple Security Officer passcodes are permissible, be sure to use the description field to keep track of which is which (since they will typically be indistinguishable without displaying the passcode).

Buttons specific to the CLI Login Manager are:

- **Add** - Adds a new entry to the CLI User list—after the current position of the selected login. (Duplicates are allowed)
- **Modify** - Overwrites the currently selected login with what’s in the main dialog.
- **Delete** - Deletes the currently selected login from the CLI User list.

Note: Discovery uses the CLI logins in the order specified in the CLI Login Manager. There is a performance hit associated with each failed login attempt. Use the up/down keys to order the list such that the most likely pair is listed first. (Use the Hints field to help identify device)

Caution: One feature for AT and iMAP devices is the ability to change their default prompts to a custom string. (For AT devices the default prompt is “>”, and for iMAP devices this feature begins with the default prompt “>>”). Therefore, this default prompt should not be changed.

There is also the option to select the protocol. The default is telnet, but here is also the option to choose SSH. These are also added to the User ID list.

Most Allied Telesis devices support SSHv2. Using SSH involves configuring and enabling the SSH server. This involves:

- Server authentication, confidentiality, and integrity
- User authentication through the use of a password and/or public key
- Connection encryption for interactive login sessions

Refer to customer documents for Allied Telesis products for support of specific SSH features.

3.2.6 Network Discovery Tab

Specific networks or portions of networks can be included in or excluded from discovery, per the list below.

Discover	IP Address	Net Mask	Start IP	End IP
<input checked="" type="checkbox"/>	10.52.30.0	255.255.255.0		
<input checked="" type="checkbox"/>	10.52.32.0	255.255.255.0		
<input checked="" type="checkbox"/>	10.52.34.0	255.255.255.0		
<input checked="" type="checkbox"/>	10.52.33.0	255.255.255.0		
<input checked="" type="checkbox"/>	10.52.35.0	255.255.255.0		
<input checked="" type="checkbox"/>	10.52.36.0	255.255.255.0		

Discover Network Entire Network Set of Nodes

IP Address: Net Mask:

Start IP: End IP:

SNMP v1 v2 v3 (Override SNMP configuration for this network)

Properties

FIGURE 3-6 Discovery Configurator – Network Discovery Tab

This tab specifies networks to discover (or exclude from discovery). The discovery process will attempt to discover devices at all IP addresses in the network (or exclude all such addresses if configured for exclusion).

Networks can be added, modified, or deleted with the **Add**, **Modify**, and **Delete** buttons.

The “Discover Network” toggle, when checked, means to discover the network. When unchecked, that network will be ignored during discovery.

The “Entire Network” radio button, when selected means to use all addresses in the network, specified by the IP Address and Net Mask fields. When “Set of Nodes” is selected instead, only the addresses from the Start IP to the End IP will be discovered.

If SNMP discovery is enabled, network discovery will normally use the parameters configured on the SNMP tab, but they can be overridden for specific networks and subnets by selecting the SNMP option on this tab. The properties to fill in depend on the SNMP version selected.

A version of SNMP can be chosen to override what is configured for the network. After choosing the SNMP version, selecting the **Properties** button allows the parameters to be filled in. Refer to the following figure.

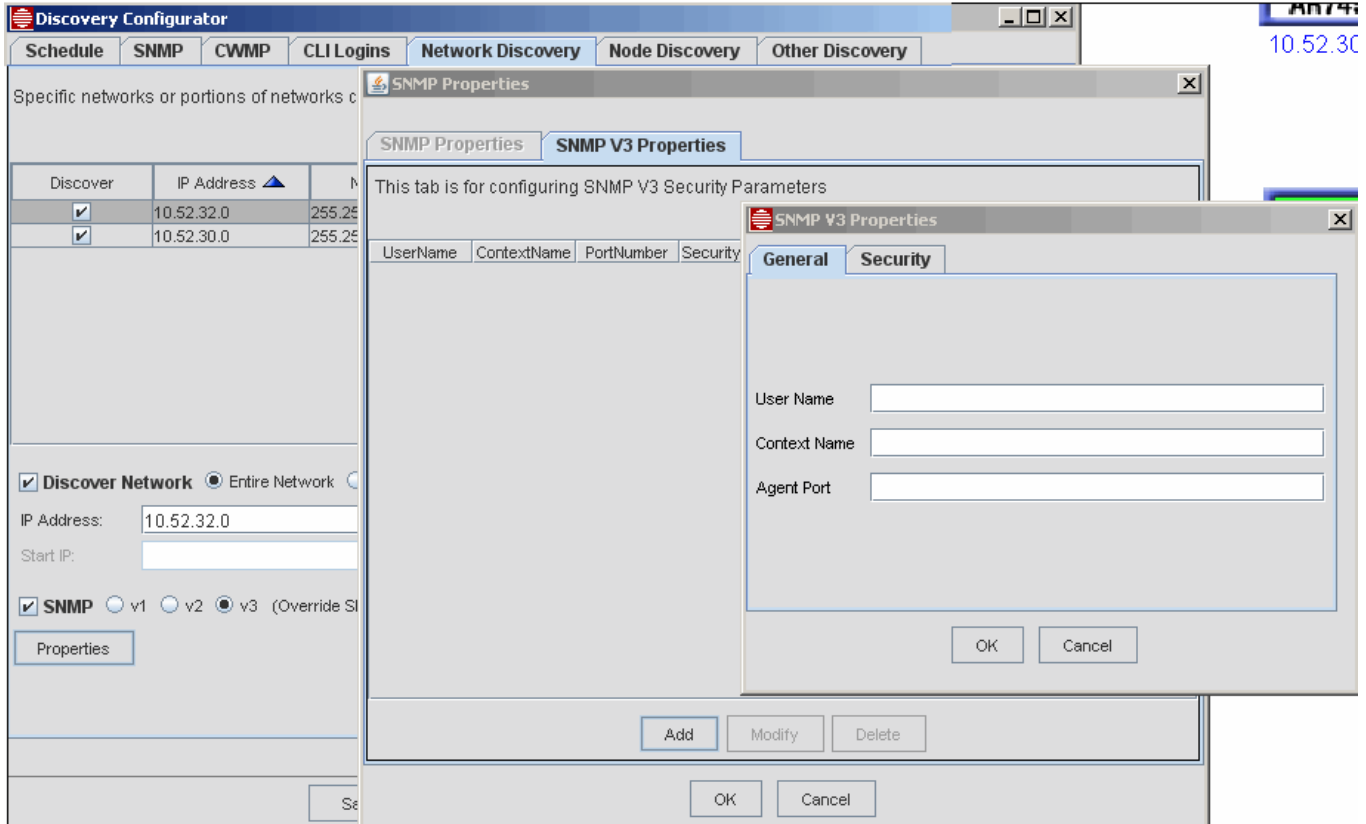

FIGURE 3-7 Setting Properties for SNMPv3

All networks, including the local net, have to be added via the network tab.

Caution: *It is not possible to delete a network from discovery once discovery begins on that network. Discovery begins any time immediately after saving changes. Therefore, to permanently remove a network from the discovery configuration, shut down the NMS to shut down the discovery process and use the standalone Discovery Configurator to delete the unwanted network. Networks are successfully deleted, however, when deleted before saving changes.*

The user can add networks and nodes in the Network Inventory screen as Managed Objects and this will take effect immediately. The menu choice:

- *Network Inventory / Edit -> Add Network*
- *Network Inventory / Edit -> Add Node*

brings up the dialog to add a network or node. Refer to 3.2.9.2.

3.2.7 Node Discovery Tab

Specific nodes can be included in or excluded from discovery, per the list below.

Discover	Parent Net	IP Address	Net Mask	Community	Version	Port
<input checked="" type="checkbox"/>	<input type="checkbox"/>	10.52.200.122	255.255.255.0			
<input checked="" type="checkbox"/>	<input type="checkbox"/>	10.52.200.110	255.255.255.0			
<input checked="" type="checkbox"/>	<input type="checkbox"/>	10.52.30.37	255.255.255.0			

Discover Node Discover Parent Network

IP Address: Net Mask:

SNMP v1 v2 v3 (Override SNMP configuration for this node)

Community: Port:

User Name: Context Name:

FIGURE 3-8 Discovery Configurator – Node Discovery Tab.

This tab specifies specific nodes to discover (or exclude from discovery).

Nodes can be added, modified, or deleted with the Add, Modify, and Delete buttons.

The “Discover Node” toggle, when checked, means to discover the node. When unchecked, that node will be ignored (excluded) from discovery.

The “Discover Parent Network” tab means to discover all the devices in the parent network, as well. The parent network will be considered to be all IP addresses in the same subnet as the node as defined by its IP Address and its Net Mask. When unchecked, only the one node will be discovered.

The SNMP version used can be selected here as well, with the properties determined by the version, as shown in the following figure.

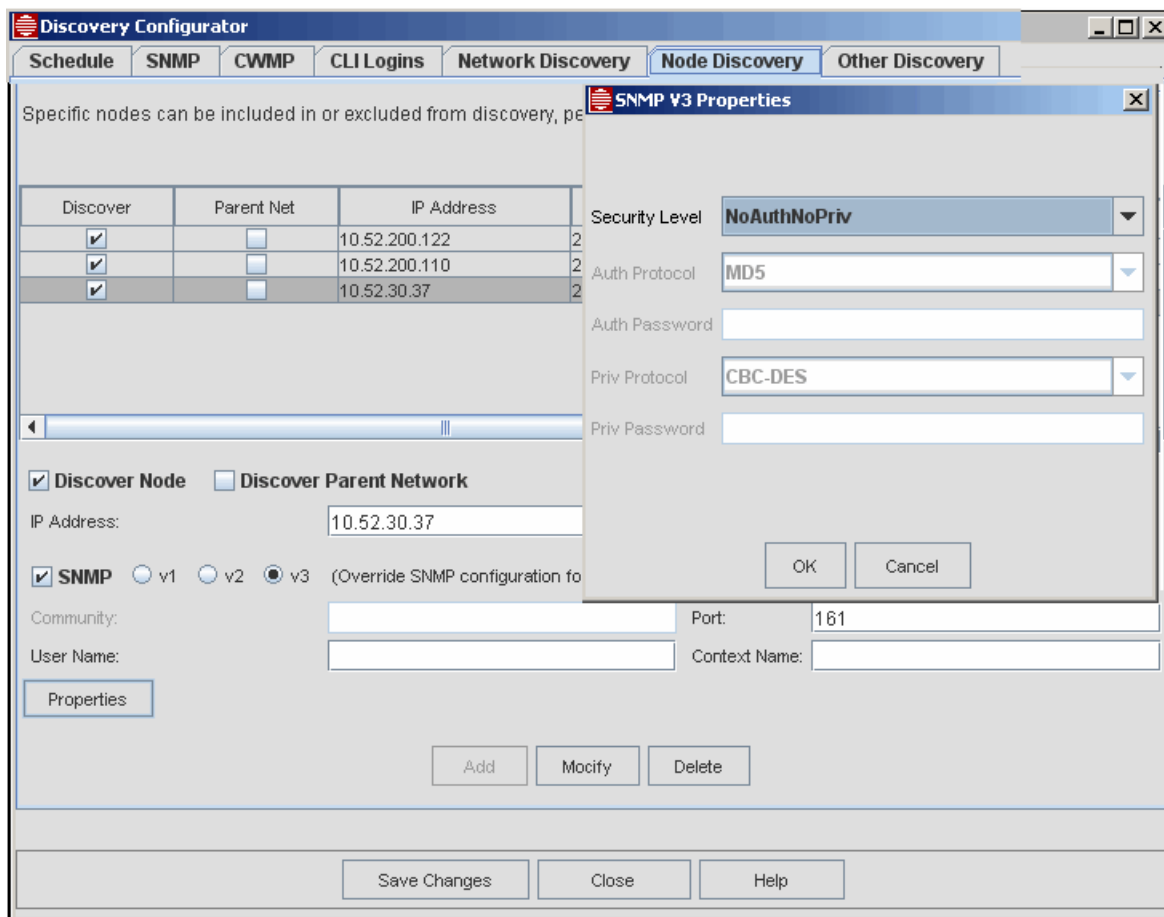

FIGURE 3-9 Setting Properties for SNMPv3

The user can add networks and nodes in the Network Inventory screen as Managed Objects and this will take effect immediately. The menu choice:

- *Network Inventory / Edit -> Add Network*
- *Network Inventory / Edit -> Add Node*

brings up the dialog to add a network or node. Refer to 3.2.9.2.

*Note: If nodes are failing initial discovery, change the "Retries" parameter (default 0) and the "Timeout" parameter from the **SNMP** Tab, and then use the *Network Inventory / Edit -> Add Node* to retry initial discovery.*

3.2.8 Other Discovery Tab

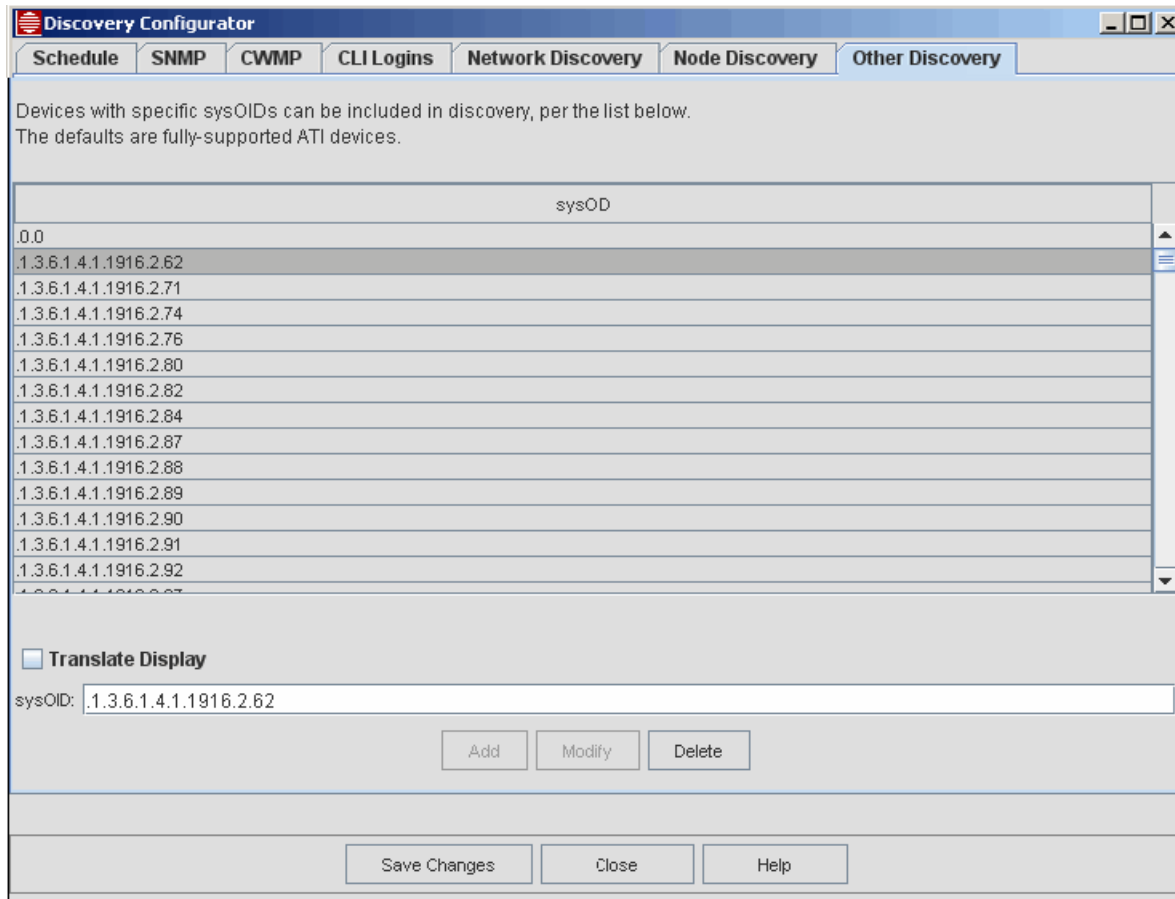

FIGURE 3-10 Discovery Configurator – Other Discovery Tab

This tab lists sysOIDs (SNMP system Object Identifiers) of devices to be included for discovery. Any device discovered by way of SNMP will be rejected unless its sysOID is one of these from this table. The defaults for this table are the Allied Telesis devices fully-supported by the AlliedView NMS.

As shown below, the “Translate Display” toggle can be checked to display sysOIDs as translated names, provided the names are adequately defined by the MIBs installed with the AlliedView NMS. Names will be a mix of numbers and names where available MIBs are not complete. When unchecked, sysOIDs are displayed as instance identifiers (numbers only).

Additional sysOIDs can be added, modified, or deleted with the Add, Modify, and Delete buttons. Added sysOIDs can be displayed and minimally managed (live status monitoring, for example).

When adding or modifying sysOIDs, names or numbers may be entered into the sysOID text field whether or not the “Translate Display” toggle is selected. Names will be resolved to numbers if the appropriate MIBs are installed. Otherwise the user will be prompted to enter the sysOID in numeric form.

The default sysOIDs cannot be modified or deleted.

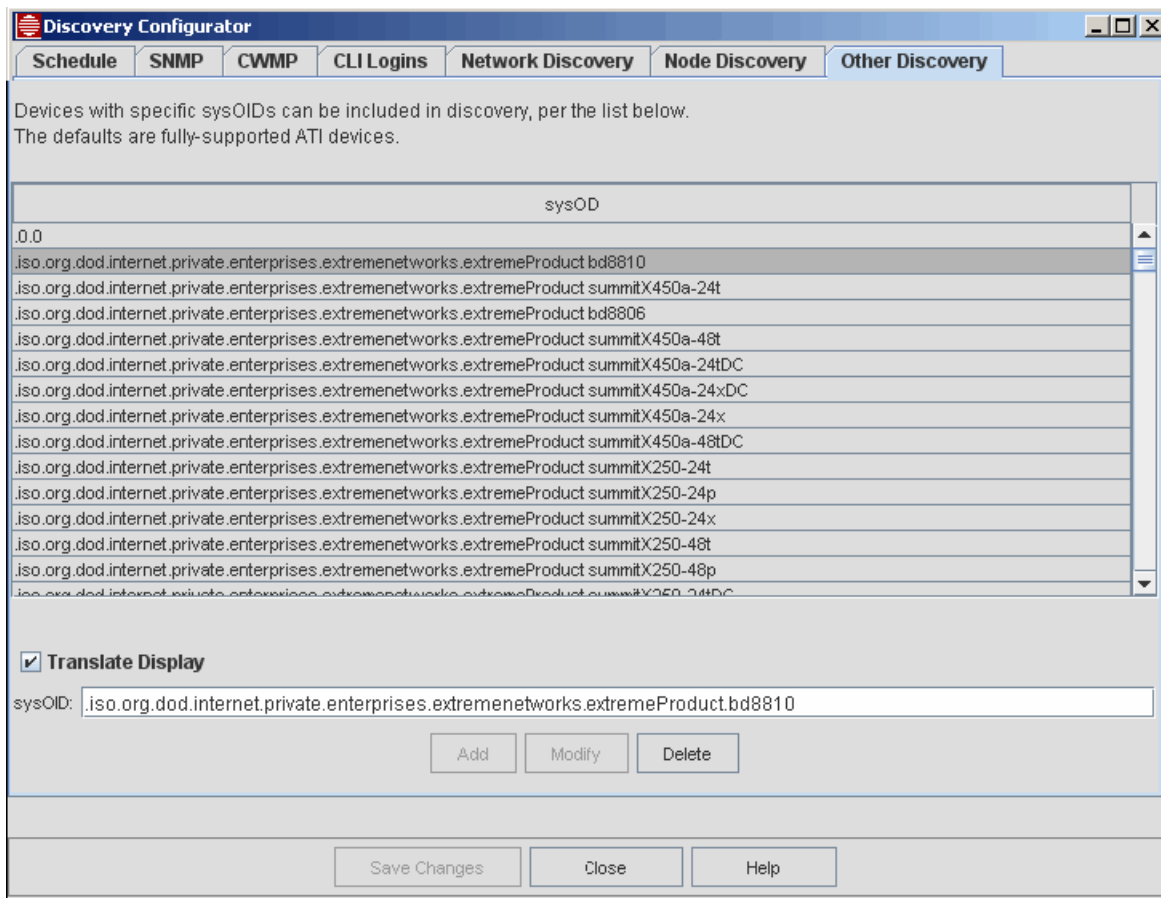

FIGURE 3-11 Discovery Configurator – Other Discovery Tab - Translate Display Option

3.2.9 Example Configurations

3.2.9.1 Setting up Discovery - Procedure

The tabs in the Discovery Configurator from right to left are the sequence that should be followed when setting up discovery. The following procedure should be done when the NMS has just been installed and the server has not been started.

1. Open up the standalone Discovery Configurator (using the DiscoveryConfigurator executable)
2. Follow the tab sequence and set up the criteria for initial discovery, including schedule, global and per-device SNMP communities, CLI logins, Network Discovery, and Node Discovery. Use the Other Discovery tab to add any other devices that are not ATI devices supported by the NMS.
3. Save the changes and exit the Discovery Configurator.
4. Start the NMS server.
5. Bring up an NMS client.
6. As networks/device are initially discovered, they appear in the various GUIs for the NMS. Rediscovery is then determined by the schedule set in the Schedule tab.

With the networks/nodes now discovered and the NMS active, the administrator may need to change the discovery configuration. In this scenario, you would bring up the Discovery Configurator and make any changes. When the **Save Changes** button is selected, the changes will take effect depending on what is set in the schedule tab. If you wish for the changes to occur immediately, you will need to stop and then restart the server.

3.2.9.2 Adding a Network or Node from the Network Inventory

To immediately add an individual node or network, the administrator goes to the Network Objects tree, selects Network Inventory node, and then clicks from the pull-down menu *Edit -> Add Node* or *Edit -> Add Network*. This brings up the Add Node and Add Network panels as shown in the following figures.

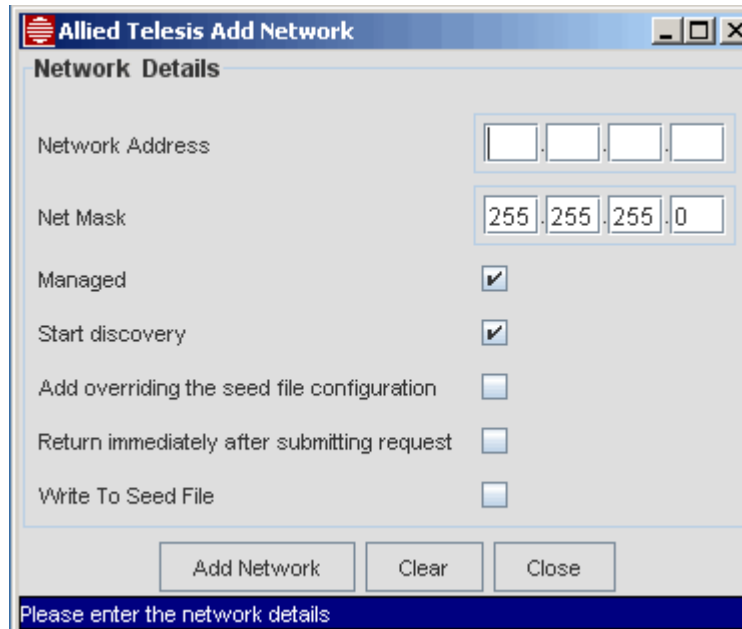

The screenshot shows a dialog box titled "Allied Telesis Add Network". The dialog has a "Network Details" section with the following fields and options:

- Network Address: Four empty text boxes for IP address entry.
- Net Mask: Four text boxes containing "255", "255", "255", and "0".
- Managed:
- Start discovery:
- Add overriding the seed file configuration:
- Return immediately after submitting request:
- Write To Seed File:

At the bottom of the dialog are three buttons: "Add Network", "Clear", and "Close". A status bar at the very bottom of the dialog contains the text "Please enter the network details".

FIGURE 3-12 Add Network (From Network Inventory)

Add Node

SNMP

Discovery Configurations

Node Type IPV4 IPV6

IP Address / Host Name

Netmask . . .

Discover even if node is not reachable?

Discover all devices in parent network?

Override Seed.file filters?

Update configurations in Seed.file?

SNMP Configurations

Community

SNMP Agent Port

SNMP V3 Enabled?

User Name

Context Name

Process Add Node request in the background

Add Node

FIGURE 3-13 Add Node (From Network Inventory)

3.3 Discovery Configurator (EE)

3.3.1 Overview

The EE version of the Discovery Configurator is available in NMS Release 12.0, is similar to the SE version but has the following features:

1. The GUI allows enabling/disabling of Discovery
2. ICMP Discovery (using Ping) can be configured, and SNMP Discovery is optional.
3. The local network can be discovered using a simple option.
4. Rediscovery can be disabled.
5. DHCP support is provided.
6. There is no sysOID filtering.

The EE version supports more discovery options than the SE version, as shown in the following figures.

3.3.2 Basic Tab

The *Basic* tab is displayed where the SE version displays the *Schedule* tab. Refer to the following figure.

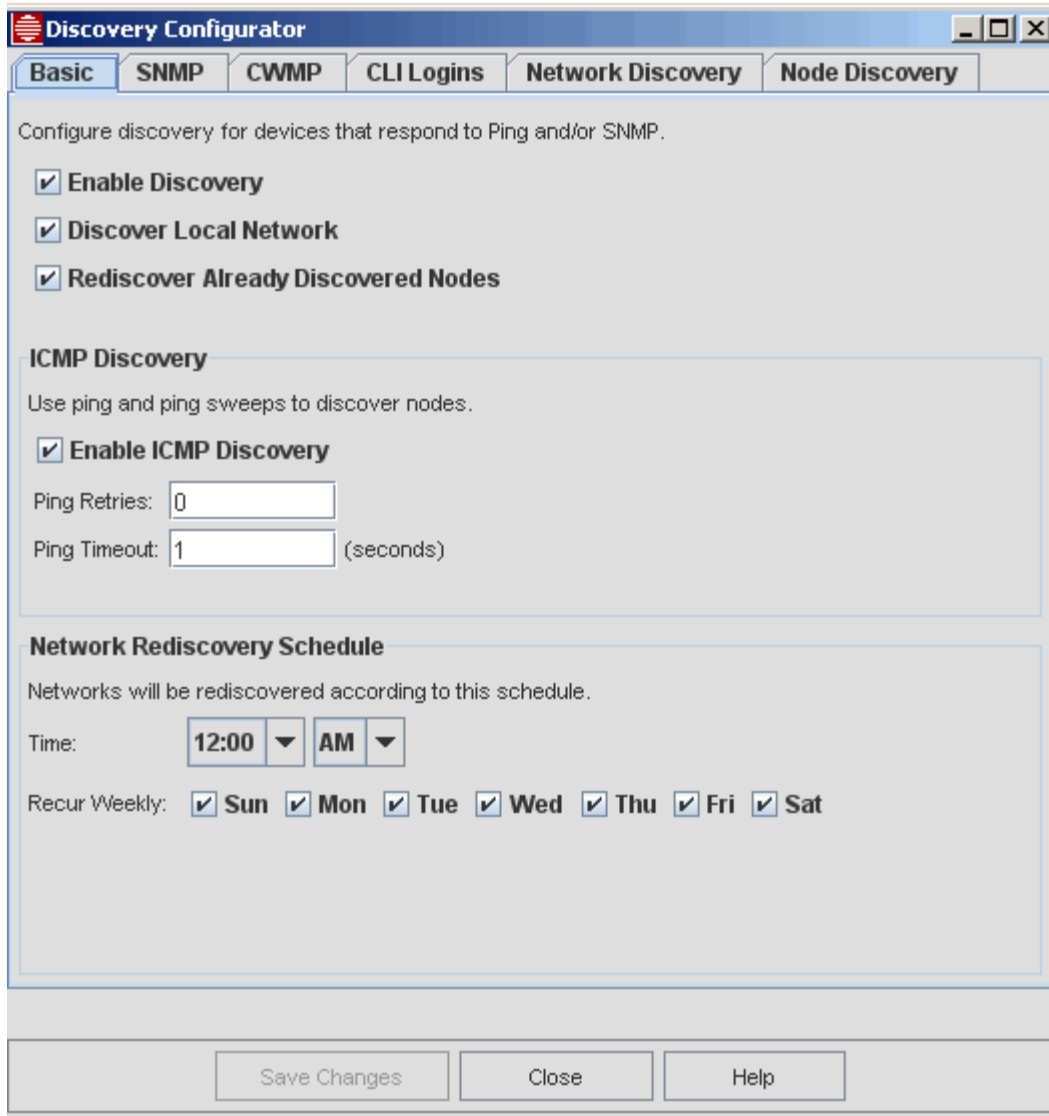

FIGURE 3-14 Basic Tab - EE Version

Buttons for the Basic tab are:

- **Enable Discovery** -The default is checked; if not checked, Discovery will not be performed.
- **Discover Local Network** - The default is not checked; if checked, nodes from the local network (where the NMS resides) are discovered.
- **Rediscover Already Discovered Nodes** - If checked (the default), nodes already discovered are rediscovered based on the rediscovery interval that has been set. If not checked, the node will not be rediscovered (and updates will not be detected).
- **Enable ICMP Discovery** - If checked (not the default), ICMP Ping is used for discovery.
 - **Ping Retries** - Number of times an ICMP Ping will be resent.
 - **Ping Timeout** - Number of seconds the Configurator waits before assuming there will be no response.
- **Rediscovery Schedule** - Choose an hour and one or more days of the week. Nightly rediscovery is recommended (default), but any number (including none) can be selected. No more than once every 24 hours is allowed.

3.3.3 SNMP Tabs

Refer to the following figure.

Discovery Configurator

Basic **SNMP** CWMP CLI Logins Network Discovery Node Discovery

Devices will be discovered if they respond to one of the SNMP Read Communities in the list below.
For each IP address, communities will be tried in the order listed until one succeeds or they all fail.

Enable SNMP

Communities

Read Communities	Write Communities
public	private
notpublic	public
	friend

Read: Write:

▲ ▼ Add Modify Delete ▲ ▼ Add Modify Delete

Parameters

Port(s): Timeout: Retries:

SNMP v3

Enable SNMPv3 Discovery Context Name:

User Names

User Name:

▲ ▼ Add Modify Delete

Save Changes Close Help

FIGURE 3-15 SNMP - EE Version

SNMP discovery can be enabled or disabled. If disabled, the rest of this tab is grayed-out. If enabled, the NMS will use this configuration during network discovery to test IP addresses for the presence of SNMP-enabled devices. Devices that respond will be added to the NMS database and will be monitored for status polling by periodically polling selected system variables (such as sysDescr).

The NMS performs “SNMP Ping” operations with each of the given read communities until a device responds or all communities have been tried and failed. (SNMP Pings are essentially SNMP get requests for selected system variables. Devices that respond are considered “connected” and those that don’t are considered “unreachable”)

3.3.3.1 SNMPv2

For most devices, only read communities are used during discovery. Some devices, including iMG/RGs, require discovering write communities as well.

Communities will be attempted in the order displayed. The order may be modified by selecting a row and then clicking on the up/down buttons.

Communities may be added, modified, or deleted with the **Add**, **Modify** or **Delete** Buttons. The Add button will add to the list whatever is in the Read or Write text field. The Modify button will replace whatever is in the selected row with whatever has been typed in the Read or Write text field.

The SNMP agent port, timeout, and retry count can be configured as well. The defaults are 161, 10, and 0 respectively. Whereas 161 is the most commonly used SNMP agent port, others can be added as a space-separated list. Each port will be tried in the given order.

3.3.3.2 SNMPv3

There is the option enable SNMPv3 Discovery, which adds security and administration features. (For information on the relationships between the SNMP versions refer to RFC 3416.)

The SNMP panel allows the addition of Users following the User-based security model defined in RFC 3414. As RFC 3416, states, it is up to the only those principals (users) having legitimate rights can access or modify the values of any MIB objects supported by that entity.

The SNMP panel includes the Enable SNMPv3 Discovery option, as shown in [Figure 3-16](#). User Names are added by typing in the User Name field, the Context Field, and then selecting **Add**. Names can continue to be added and the order changed using the direction arrows. A name can be modified by selecting a name, changing the name in the User name field, and selecting **Modify**. Selecting Save Changes writes the values to the NMS

3.3.4 CWMP Tab

The CWMP (Common WAN management Protocol) Discovery tab is added for TR-69 Support. This tab allows setting the ACS (auto configuration server) login credentials on the NMS and creating a list TR-69 connection request login credentials for iMGs.

3.3.5 CLI Logins Tab

Refer to the following figure.

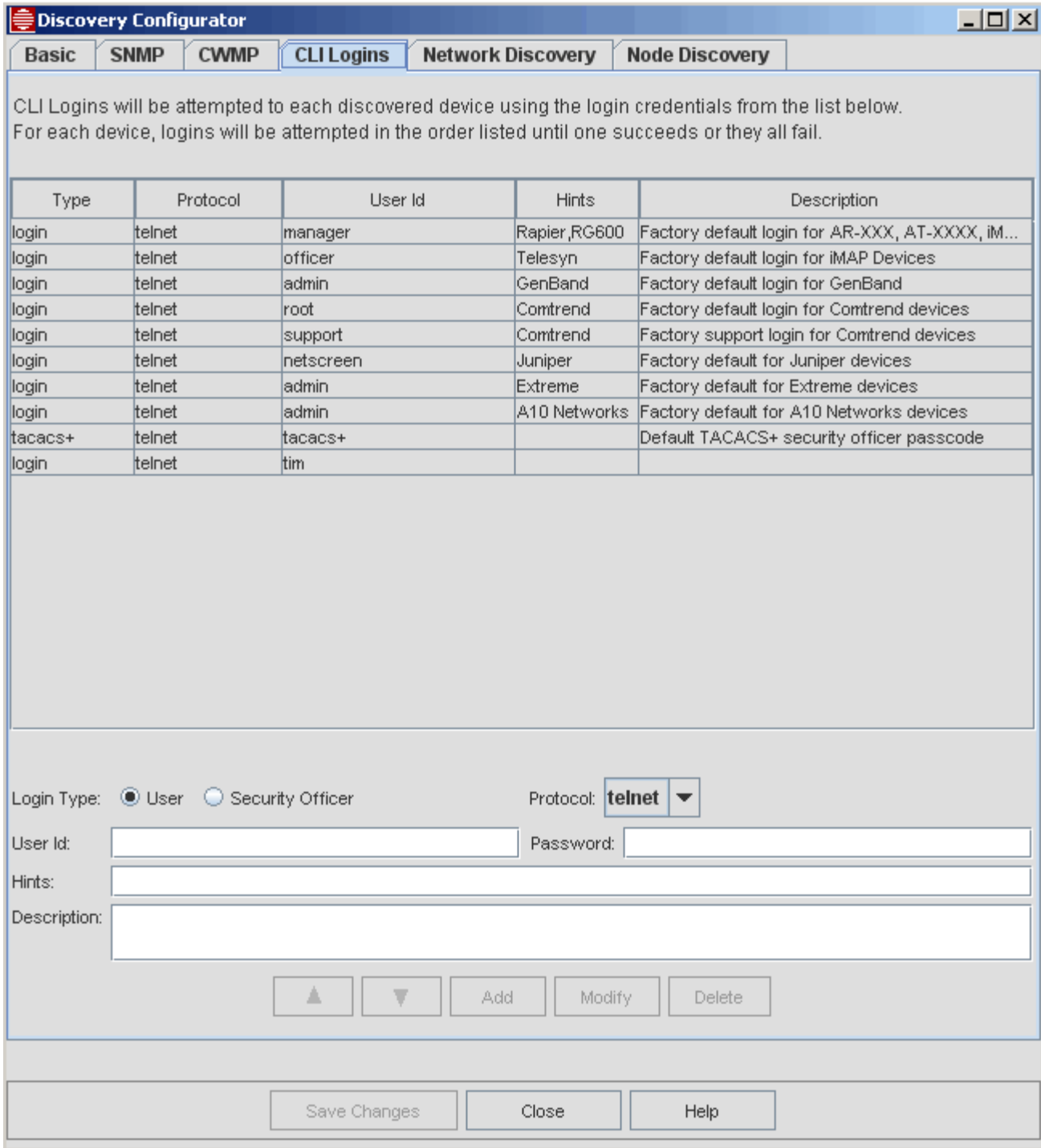



FIGURE 3-16 CLI Logins Tab - EE Version

Status polling via ICMP or SNMP does not require CLI access; CLI discovery is only required when device configuration (backups, port management, VLAN management, etc.) is desired and is only applicable to fully-supported devices (refer to Section 1).

Once a device has been discovered by way of SNMP, more detailed discovery requiring a CLI login is required to manage the device. The NMS will attempt to log into each device until it either discovers an accepted login or all login attempts are rejected. The login sequence generally follows the order of the logins in the table. The order may be modified by selecting a row and then clicking on the up or down ( ) buttons.

The login sequence can be overridden by the Hints field. Hints are a comma-separated list of device category, sysLocation, IP address, and subnets (in x.x.x.x/bits notation). Login parameters for a device that matches any of the hints will be attempted before any other login parameters. If there are more than 1 login entry with matching hints, they will be attempted in the sequence from the list.

If all login attempts with matching hints fail, all of the entries without hints will be attempted until one is accepted or all are rejected. And if all of those fail, all of the rest (without matching hints) will be attempted.

The Description field is a free format reminder of what each login entry represents.

There are 2 login types: User and Security Officer, which are specified by the radio button. The “user” type uses the User Id and Password to initially log into the device. User login is all that's required for iMAPs running without TACPLUS.

If a device is running with TACPLUS enabled, the NMS also needs a Security Officer passcode (to enable securityofficer). Security Officer passcodes can be designated by clicking on the Security Officer radio button. For Security Officer, the User Id field is not applicable and will be disabled and set to “tacacs+”. (You can still define a user login with the user id tacacs+, if necessary, by clicking on the User radio button instead of the Security Officer radio button) Security Officer passcodes will be attempted as ordered in the list and as overridden by Hints. Since multiple Security Officer passcodes are permissible, be sure to use the description field to keep track of which is which (since they will typically be indistinguishable without displaying the passcode).

There is also the option to select the protocol. The default is telnet, but here is also the option to choose SSH. These are also added to the User ID list.

Most Allied Telesis devices support SSHv2. Using SSH involves configuring and enabling the SSH server. This involves:

- Server authentication, confidentiality, and integrity
- User authentication through the use of a password and/or public key
- Connection encryption for interactive login sessions

Refer to customer documents for Allied Telesis products for support of specific SSH features.

3.3.6 Network Discovery Tab

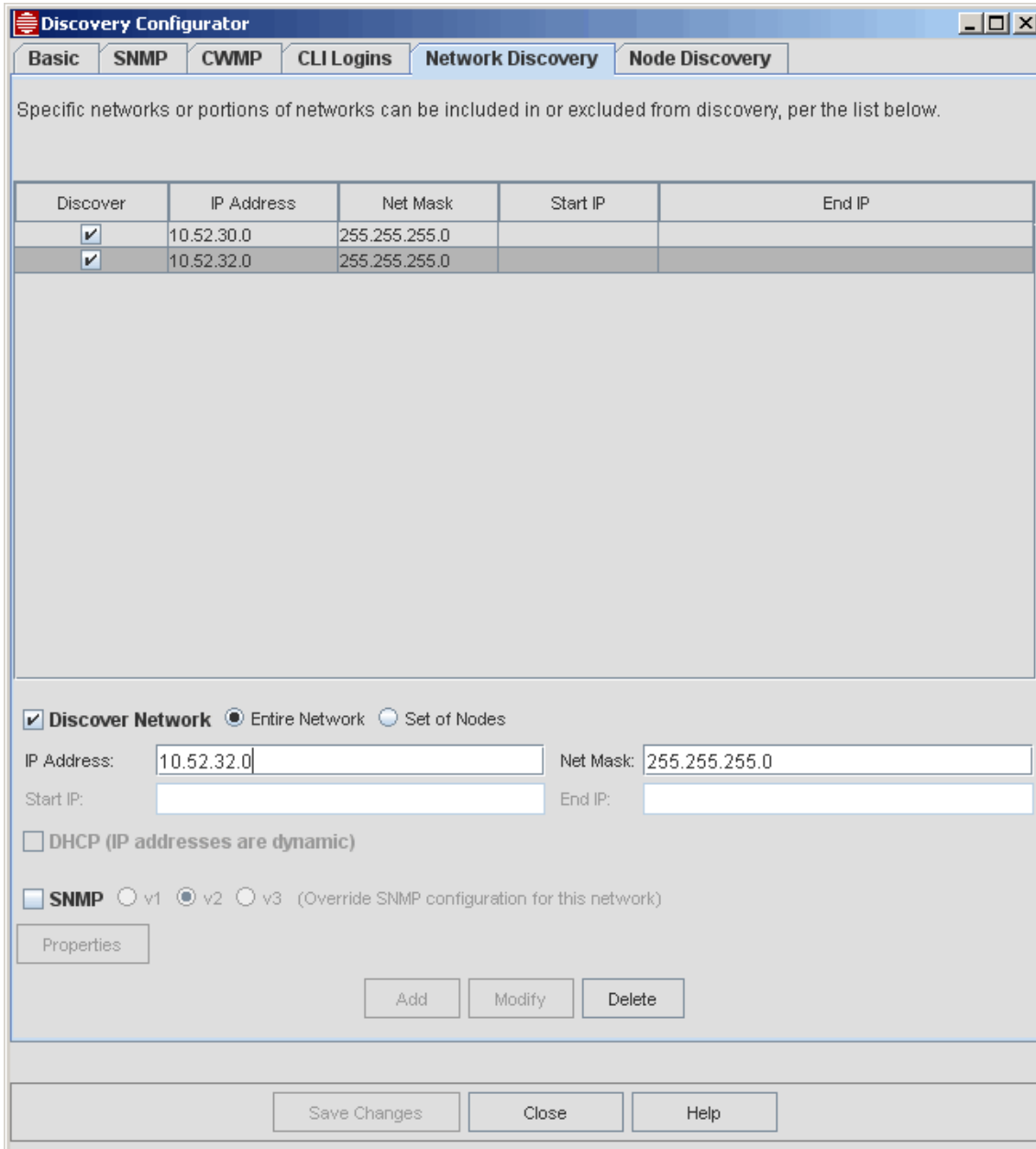

FIGURE 3-17 Network Discovery Tab - EE Version

This tab specifies networks to discover (or exclude from discovery). The discovery process will attempt to discover devices at all IP addresses in the network (or exclude all such addresses if configured for exclusion).

Networks can be added, modified, or deleted with the **Add**, **Modify**, and **Delete** buttons.

The “Discover Network” toggle, when checked, means to discover the network (or subnet). When unchecked, that network (or subnet) will be ignored during discovery.

The “Entire Network” radio button, when selected, means to use all addresses in the network, specified by the IP Address and Net Mask fields. When “Set of Nodes” is selected instead, only the addresses from the Start IP to the End IP will be discovered.

When “Set of Nodes” is selected, the DHCP option becomes available. Use this option if IP addresses are assigned dynamically. The NMS will then use MAC addresses to identify hosts rather than IP addresses or host names.

If SNMP discovery is enabled, network discovery will normally use the parameters configured on the SNMP tab, but they can be overridden for specific networks and subnets by selecting the SNMP option on this tab. The properties to fill in depend on the SNMP version selected.

A version of SNMP can be chosen to override what is configured for the network. After choosing the SNMP version, selecting the **Properties** button allows the parameters to be filled in.

Caution: It is not possible to delete a network from discovery once discovery begins on that network. Discovery begins any time immediately after saving changes. Therefore, to permanently remove a network from the discovery configuration, shut down the NMS to shut down the discovery process and use the standalone Discovery Configurator to delete the unwanted network. Networks are successfully deleted, however, when deleted before saving changes.

3.3.7 Node Discovery Tab

Specific nodes can be included in or excluded from discovery, per the list below.

Discover	Parent Net	IP Address	Net Mask	Community	Version	Port
<input type="checkbox"/>	<input type="checkbox"/>	255.255.255.0	255.255.255.0			

Discover Node Discover Parent Network
 IP Address: Net Mask:
 SNMP v1 v2 v3 (Override SNMP configuration for this node)
 Community: Port:
 User Name: Context Name:

FIGURE 3-18 Node Discovery Tab - EE Version

This tab specifies specific nodes to discover (or exclude from discovery).

Nodes can be added, modified, or deleted with the **Add**, **Modify**, and **Delete** buttons.

The “Discover Node” toggle, when checked, means to discover the node. When unchecked, that node will be ignored (excluded) from discovery.

The “Discover Parent Network” tab means to discover all the devices in the parent network as well. The parent network will be considered to be all IP addresses in the same subnet as the node defined by its IP Address and its Net Mask. When unchecked, only the one node will be discovered.

If SNMP discovery is enabled, node discovery will normally use the parameters configured on the SNMP tab, but they can be overridden for specific nodes by selecting the SNMP option on this tab and supplying the version, community, and port values.

The SNMP version used can be selected here as well, with the properties determined by the version.

*Note: If nodes are failing initial discovery, you can (for SNMP) change the “Retries” parameter (default 0) and the “Timeout” parameter from the **SNMP v1/v2c** Tab, and then use the **Network Inventory / Edit -> Add Node** to retry initial discovery. If you are using ICMP, you can change the “Retries” parameter (default 0) and the **Timeout** parameter from the **Basic** Tab.*

3.4 Backup and Restore

3.4.1 AlliedView NMS Backup (On Demand)

To make an immediate backup of the server and database files, choose from the main menu **Tools -> NMS Database Backup**, and the option **On Demand**. A dialog box appears, as shown in [Figure 3-19](#).

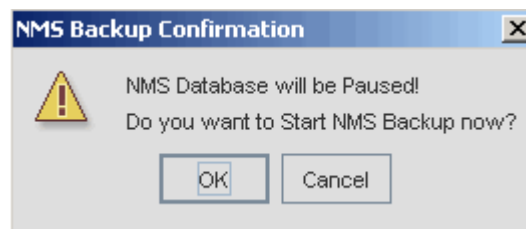

FIGURE 3-19 NMS Backup Confirmation Dialog

Clicking **OK** starts the backup process window. When finished, the window will show whether the backup was successful and where the backups were written to, as shown in [Figure 3-20](#).

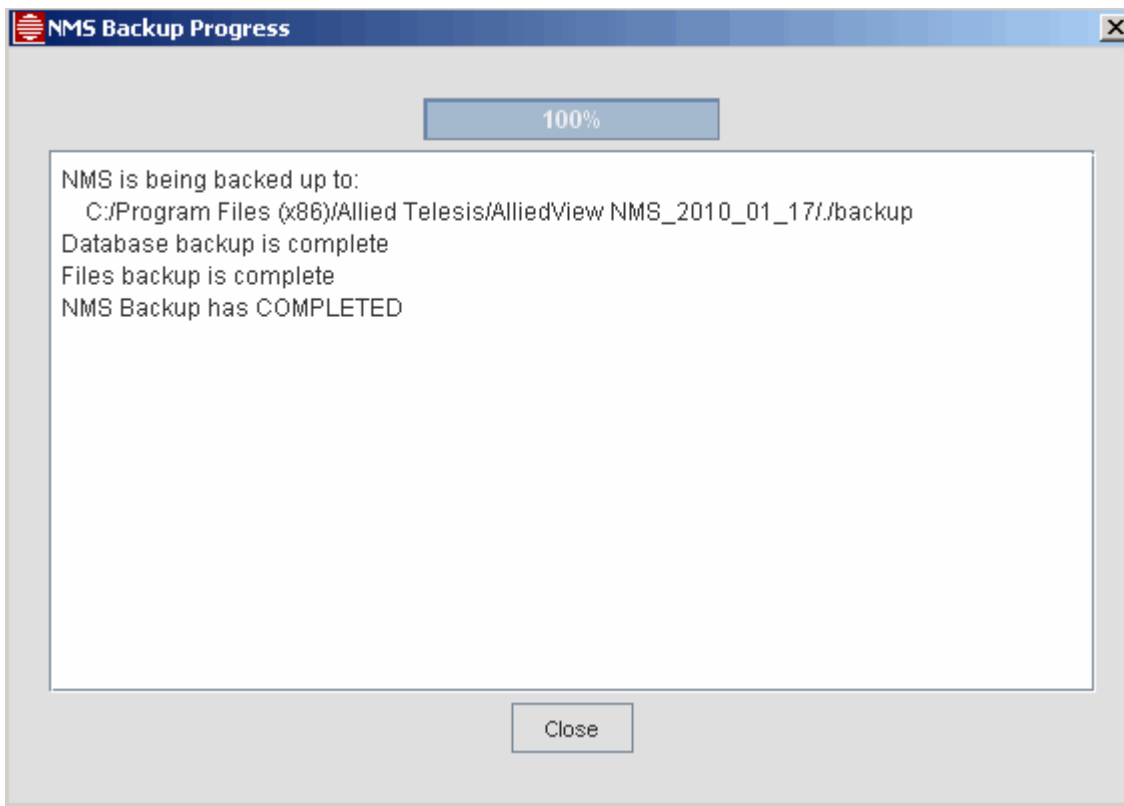

FIGURE 3-20 Backup Process Complete Window

The controlling of where the backup is written to is explained in [3.4.3](#).

3.4.2 AlliedView NMS Backup (Scheduled)

To backup the NMS server on a schedule, choose from the main menu *Tools -> NMS Database Backup*, and the option *Scheduled*. A dialog box appears, as shown in [Figure 3-21](#).

The form has the following options:

- The **Task Name** is by default the time of the backup, but the user should give a descriptive name of the type of backup (such as `NMS_weekly_backup`).
- The **Backup Destination** is part of the restore process and are explained in [3.4.3](#).
- The **Schedule** panel has the following options:
 - **Now** is for a one-time only.
 - **Hold** is to create the task and give it a task name but not to attach a specific time or schedule.
 - **One Time** is to set a time in the future when the backup will be performed.
 - **Recurring** has further options for recurring at a specific time on a weekly or monthly basis.

Caution: *It is highly recommended that the Backup Scheduler be used so that a recent snapshot of the NMS configuration may be available in case of server failure. (Backups can occur as often as once a day if desired.) Moreover, the backup should be written to a separately mounted disk. (Refer to [3.4.3](#).)*

Clicking **Submit** brings up the **Task Details** window so that the task can be modified (if needed) and then added to other NMS tasks. (Clicking **Close** on the **Task Details** window will add the task to the tasklist. This user can then view the task by selecting *Tools -> View Tasks* and perform further actions. The tasklist is described in [5.8](#).

The screenshot shows a window titled "Create NMS Backup Schedule Task". It contains the following fields and options:

- Task Name:
- Backup Destination:
- Schedule** section:
 - Now
 - Hold
 - One Time:
 - Recurring:
 - Time:
 - Recur Weekly Sun Mon Tue Wed Thu Fri Sat
 - Recur Monthly on the of the month

At the bottom of the window are two buttons: "Submit" and "Close".

FIGURE 3-21 NMS Backup Schedule

3.4.3 Configuring Backup Parameters for AlliedView NMS

A backup of the NMS configuration can be performed on demand or on a schedule. When the files are being backed up on demand, the console window shows the path where the files are being copied. When the files are being backed up on a schedule, the **Backup Destination** field (seen in [Figure 3-21](#)) shows this path.

The path used is controlled by the file:

```
<NMS_Home>/conf/AT_NmsBackupFiles.conf
```

This file includes the following parameters:

- ATINMS_BACKUP_DEST

This where the NMS backups are stored. The default is <NMS_Home>/backup

- ATIDEVICE_BACKUP_DEST

This is where device backups are stored. The default is <NMS_Home>/backup

- ATIDEVICE_BACKUP_LIMIT

Refer to [3.4.5](#).

Note: In most cases, the user should change the directory path to one where you normally send backup files. The server should have sufficient space and be reliable for backup purposes.

Note: Changes made to `AT_NmsBackupFiles.conf` are enabled as soon as the file is changed, so a server restart is not needed.

3.4.4 Restore the AlliedView NMS (GUI Screens)

There is a set of GUI screens to perform a restore.

Caution: A restore requires the server to be shut down and then restarted. If this feature is used while the AlliedView NMS is running, there is an error message. Moreover, any data changed since the last backup will be lost.

Caution: A restore should only be done on the same software version in which the backup was performed. If the software versions do not match, the following appears when starting the restore.

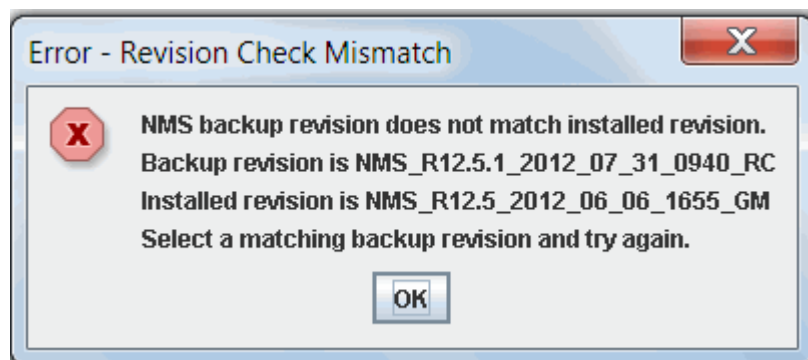

FIGURE 3-22 Warning for Software Version Mismatch for a Restore

1. Shut down the server (using the *Start -> Programs* menu path).
2. Start the tool:

For Windows, from the bin/backup directory, select `AT_NMSRestore.bat`.

On Solaris, from the bin/backup directory, execute `./AT_NMSRestore.sh`

Refer to the following figure for the Windows folder.

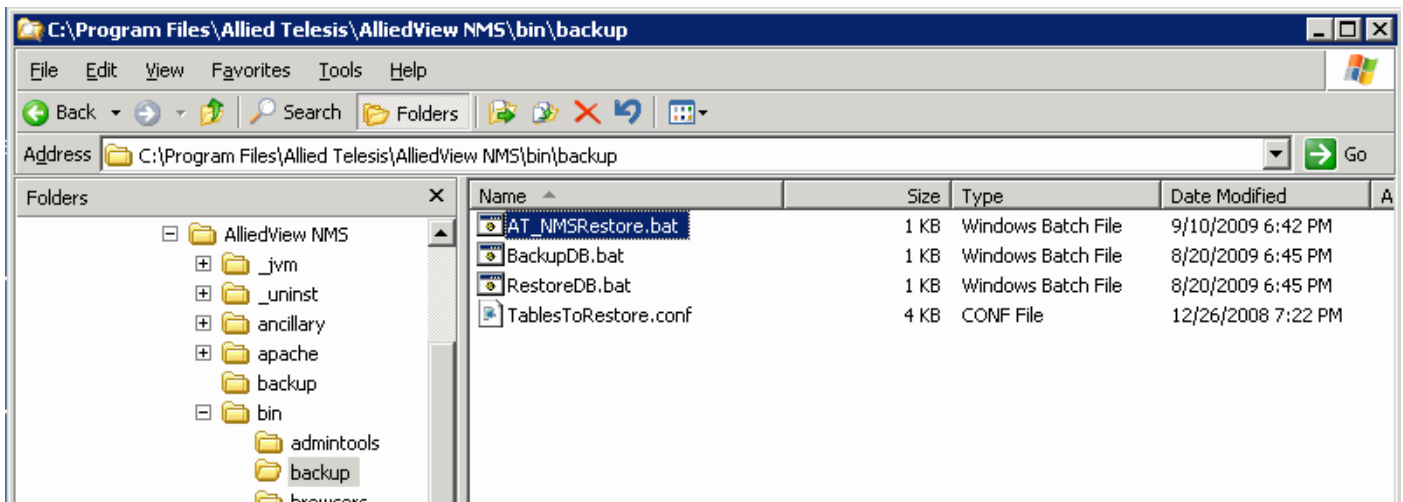

FIGURE 3-23 Starting the AlliedView NMS Recovery Feature (Windows)

3. Selecting the NMS exec file brings up the NMS Restore Tool. Use the **Browse** button to bring up the relevant backup file. In searching there is the Zip option to search through only zip type files. Refer to the following figure.

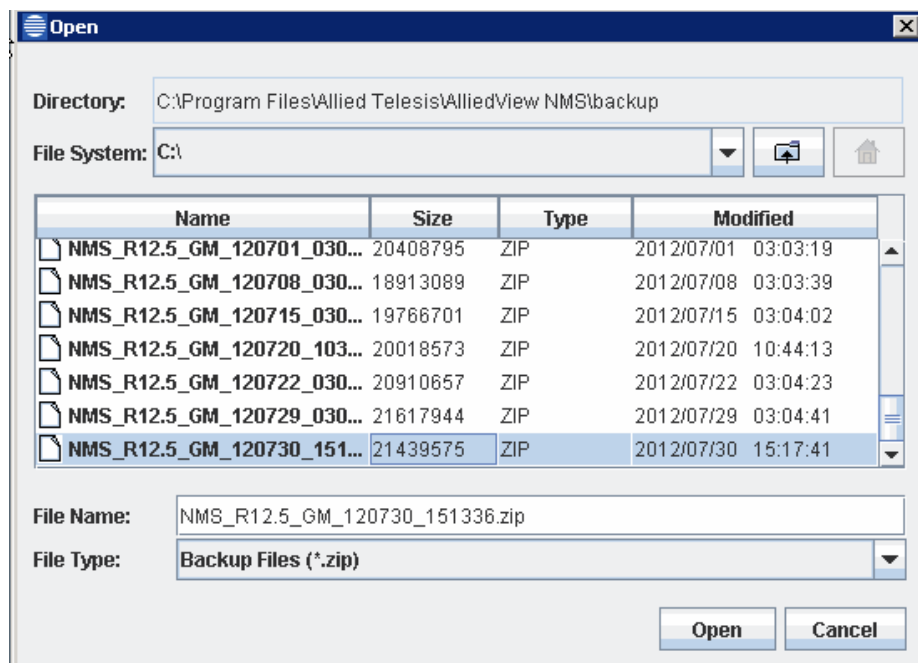

FIGURE 3-24 Selecting Files for AlliedView Restore

4. Press **Open** to bring up the NMS Restore window with the selected backup file, and then **OK** to start the restore. Progress and error messages are displayed in the Progress window during the restoration process and saved to a log file in the backup directory (this is not the bin/backup directory from where the GUI is launched). Refer to the following figures.

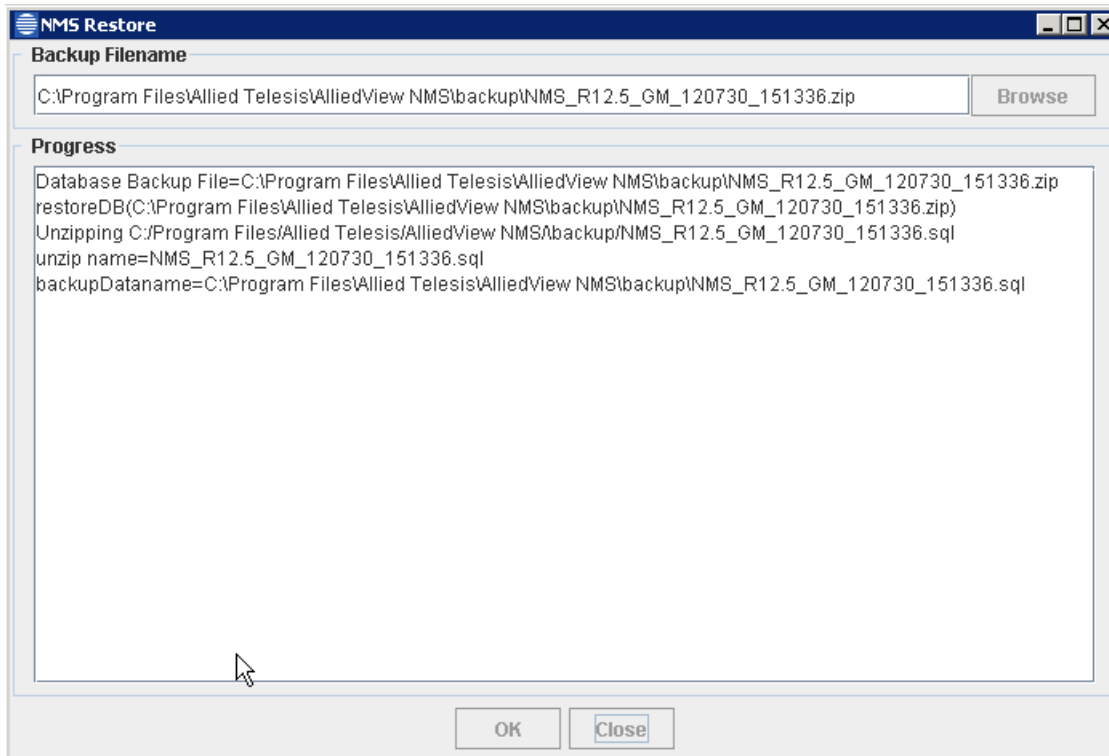

FIGURE 3-25 AlliedView NMS Restore - Start

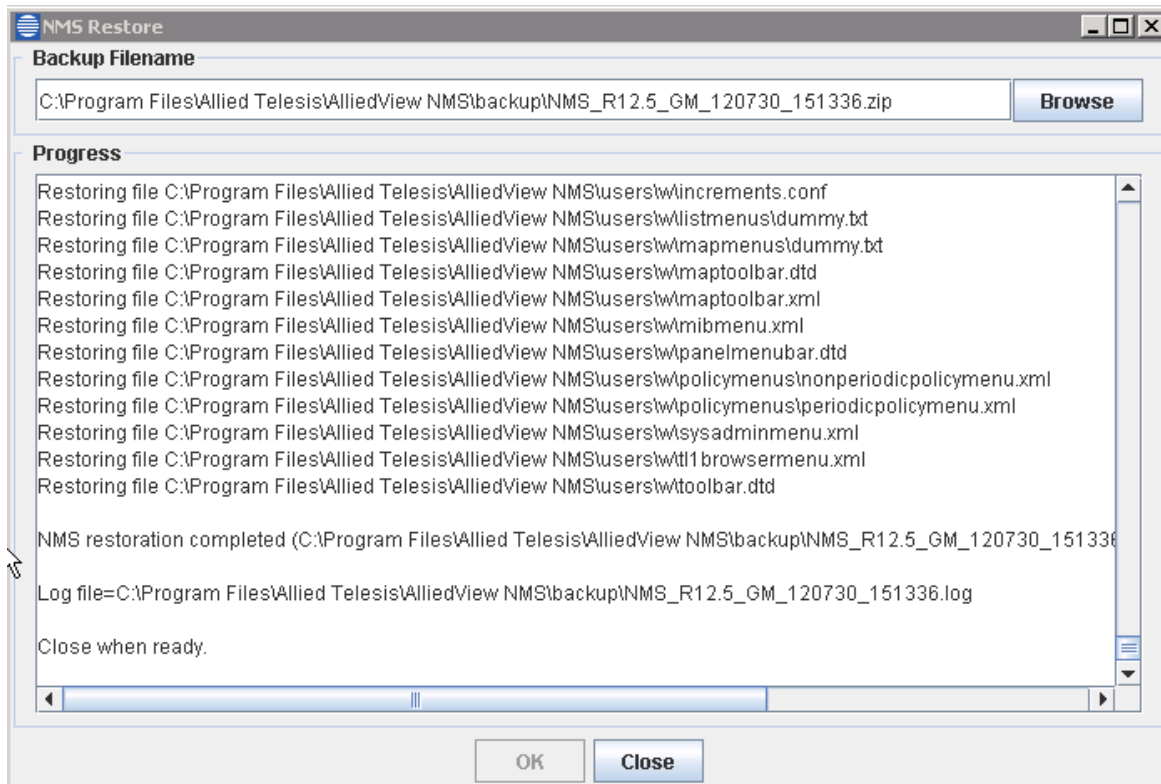

FIGURE 3-26 AlliedView NMS Restore - Finish

3.4.5 Device Backup (Per-Device Limit)

Daily backups of a large network will eventually use up all the disk memory unless customers manually purge old files. One feature to address this is using file configuration as follows:

The limit is configured in `conf/AT_NmsBackupFiles.conf`

The property is `ATIDEVICE_BACKUP_LIMIT`

Setting this to zero is equivalent to no limit.

Setting this to a non-zero number is the number of device backups allowed. For example, if you set the limit to 100, and have backups scheduled to occur daily for all devices, the AlliedView NMS will keep the most recent 100 days of backups for each device.

In another example with the limit set to 100, if you have one device with backups twice daily, the AlliedView NMS would keep the most recent 50 days for that specific device.

Note: There is a *Purge Files* button that is added to the MDTI application. Refer to [5.3.2](#).

3.5 AlliedView NMS License Manager

3.5.1 Overview

In release 10.0, there is a change to the license manager strategy that involves the following changes:

- The license key is associated with the customer who has registered the license rather than the hardware where the key was installed.
- Licensing can include the following:
 - whether the license running NMS is temporary (time limit)
 - the maximum number of nodes allowed
 - allowing access to RADIUS and max number of clients allowed
 - allowing access to the Northbound Interface.
- The details of the license key are encrypted and kept in xml format as AT_License.conf in the Conf subdirectory.

The process of obtaining a license is similar to previous releases and includes the following:

1. The customer fills out a form in which all relevant information is filled in and is sent to Allied Telesis.
2. Allied Telesis receives the form and encodes the customer information and license privileges in the file AT_LicenseKey.upd.
3. The customer receives the file and places it on the NMS server.
4. The customer uses the License Manager GUI to select this file and apply the license.
5. The customer can look at the Status Monitoring Tool and look at the License Keys node to review the Licensed User Information panel.

3.5.2 Installing a License (Using the License Key Manager)

The License Key Manager is included with the NMS release so that they can be used to apply the license key. The GUI is similar to the pre-R10.0 license key tool (called the Update Manager in release 9.0), but the License Manager has more features and presents more information when installing the key.

As in previous license keys, the new key can be installed while the server is running without affecting other services. Some sections of the key will take effect immediately (e.g. node limit), and others will take effect after the next server restart.

When a new key installed with its separate components, it will update previous key of the same component. However, existing product or component keys that are not included in the new key will not be updated. Also, the installed key will not be removable (i.e. there will be no tools to uninstall a key) but a new key can be created to reset the unwanted key to original or any other values.

Refer to the following figure, which show the License Manager Tool.

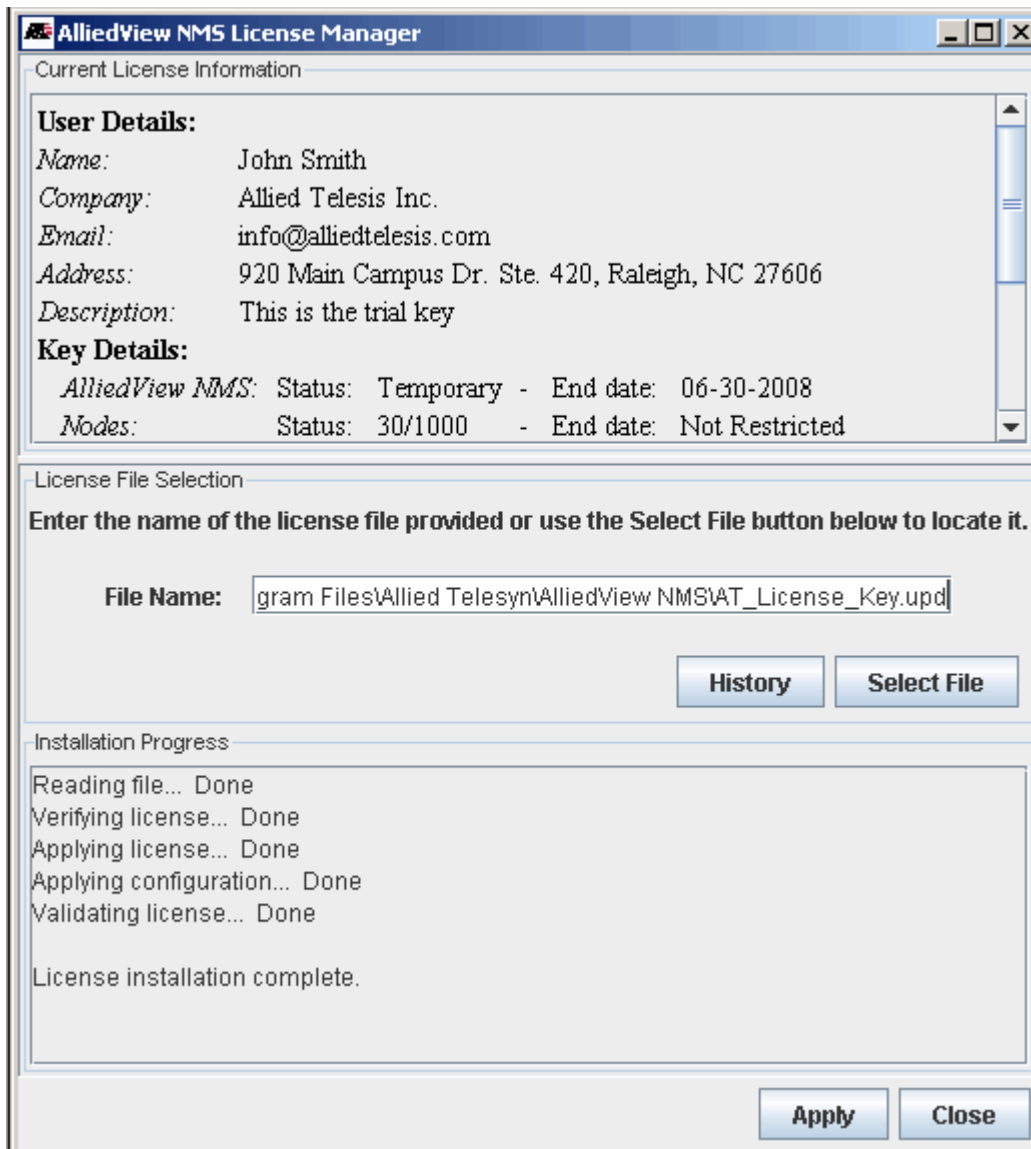

FIGURE 3-27 License Manager Tool

The license key installation user interface has three main sections:

- **Current License Information (Top):** This section has information on the key that is already installed. It displays the license status including user information, product and all components being licensed.
- **License File Selection (Middle):** This section allows the user to select the license file to be applied. The license key file is expected to be on the server and contain the correct extension and the file chooser can be used to select a file from the file system mounted in the server.
- **Installation Progress (Bottom):** This section will display status of the current license installation and the information printed here will be very useful if the installation fails.

There is also a License Key History (Separate panel): This is launched by selecting the **History** button to display the history of all licenses that have been installed on the system in the past. Refer to the following figure.



FIGURE 3-28 License History

When the user selects the Apply button, the selected file is read and checked, installed, and then verified. If there is an error during these steps, the installation will stop. If there are no errors, the key is also stored at another location if needed later for recovery.

3.5.3 Installing a License (Using the Console Mode)

License keys can also be installed and viewed in console mode where all menu options and selections are displayed and entered on a command line and GUIs will not be launched. This mode can be useful when graphical display to the NMS server is not available.

The same script will be used for launching a console mode installation using selected options with the `AT_LicenseInstaller.bat` command.

```

cd <NMA_HOME>/bin
AT_LicenseInstaller.bat -help
Printing help: -help

Usage (all parameters are optional):
AT_LicenseInstaller [options]
Where options are:
-help - Print this message (cannot be used with other
options)
-g - Run in GUI mode (default and all other options
are ignored)
-c - Run in console mode (other options may be added)
Parameters below can only be used in console mode (-c) if
needed to bypass text menu options.
-s - Display current license key status
-h - Display license key installation history
-i ... - Install a new license key (license file must be
specified)

```

Note that all options can be passed on a command line when running the installer or the installer can be executed with the - c option and others can be selected from the key installation menu. This flexibility allows calling the license key installer from other programs in special circumstances if needed to bypass instructions menus.

```

=====
                AlliedView NMS License Manager
=====
AT_LicenseInstaller.bat -c
Please select from the license key menu below using the characters on the left to con-
tinue...

S - Display current key Status
H - Display key installation History
I - Install new license key
Q - Quit (Exit)
Select an option:

```

Options from the menu above will display the same information as when the GUI is used and the selections will also perform the same function as when GUI is used.

3.5.4 Verifying the License After Installation

3.5.4.1 Product Validation

Validating the product key has the following scenarios:

- **Server startup** - If the product key is found to be invalid the server will stop, and the following appears. This occurs because the key is invalid or has expired.

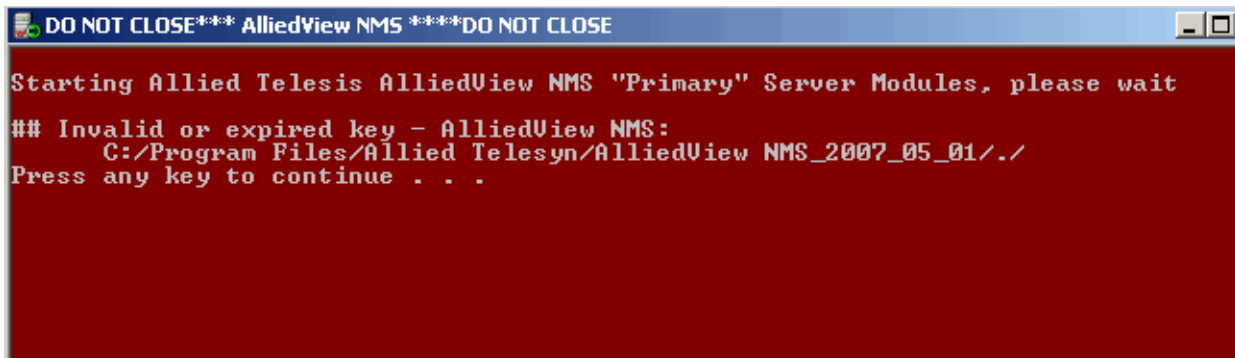

FIGURE 3-29 License Expired/Invalid at Server Startup

- **Server runtime:** Once the server has started, and if the key is found to be invalid, the server is stopped. There will be warning messages in the logs that allow the user to correct the problem before the server is stopped.

3.5.4.2 Viewing Licensed User Information

Once the license is applied, select *Tools -> Status Monitoring*, then select **License Keys** to see the license information for the customer. The following subsections go through the license features.

3.5.4.3 Node Limit Validation

There is already a Node limiting feature, and this is being included with the License Manager in Release 10.0. If the new license includes this feature and a new maximum count, it will not be a replacement to current maximum value, and when the key is applied the old value will be replaced with new value. Therefore, Allied Telesis and the customer should compare records to ensure there is agreement on the value to be used.

The maximum node count can also be decreased with the License Manager, setting the value lower than what was set in 9.0. If there are already more nodes than the new value, the extra nodes will not be deleted but new nodes will not be allowed until some are deleted to make the count lower than new value.

This feature includes the option to have expiration dates so that more nodes can be added for specific time, and the value will automatically reset to default value when the time expires. Also in normal run the maximum node limit can be reset to a default value when the key is detected to be invalid or expired.

3.5.4.4 Northbound Interface Validation

Access to Northbound interface APIs can be time-based, and access to the APIs is blocked when the time expires. Note that when this occurs, all APIs are blocked. (For Northbound Interface, refer to Section 12.)

3.5.4.5 Maximum Allowable Client Logins

Prior to Release 10.0, the maximum available active clients was limited to five (5) on a single NMS server. (This was the default.) In release 10.0, this maximum can be increased to 15.

3.5.4.6 RADIUS License Information

The RADIUS feature allows access to RADIUS server authentication, and the attributes are listed.

3.5.5 Viewing the License Configuration

When the NMS first starts up, the initial splash screen will include text on licensing. This information is also included in the About menu item. Refer to the following figures.



FIGURE 3-30 Splash Screen at Startup

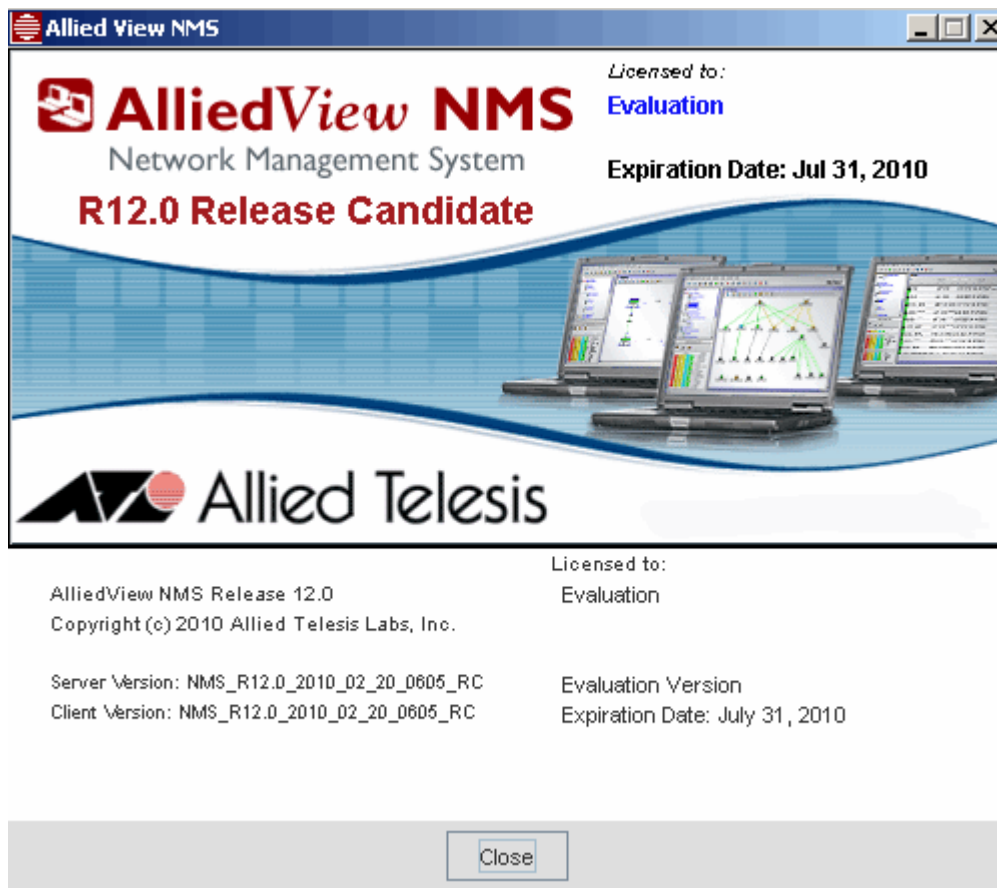

FIGURE 3-31 About NMS Screen

The License Key information is also included in the Status Monitoring Panel. Refer to [3.9](#).

3.5.6 Migrating Existing Licenses

NMS License Keys issued prior to R10.0 will no longer be valid. Therefore effective with NMS R10.0, all customers upgrading from R9.0 to R10.0 will be required to get a new license key from Allied Telesis.

Upgrading a properly licensed NMS R9.0 server to R10.0 will result in the license status being placed back into Evaluation status. Allied Telesis is making every effort to contact all existing customers with new R10.0 compatible license keys to minimize customer inconvenience.

3.6 File Keys to Identify Downloadable Files

3.6.1 Overview

As explained in Section 5.3.9, Software Configuration is an MDTI application that downloads OS releases onto supported devices/components. Since there are many steps and constraints involved in this operation, the MDTI application is a considerable simplification of the process, especially when downloading to multiple devices. The application uses a file on the NMS to identify the files that can be downloaded on devices according to their device types. This file also encodes file relationship constraints.

In previous releases, the data store was static within an NMS release, which meant new OS releases delivered after a particular NMS release could not be downloaded to existing devices. The Custom Software Download feature gives users a safe way to modify the data so newer OS releases can be downloaded to existing devices without waiting for a new NMS release or patch.

Note: NMS applications are not necessarily expected to support devices running advanced releases but will make a best effort in order to do so.

Using the Custom Software Download feature, explained in Section 5.3.10, the user can modify the file that stores the **OS release files**. These custom (usually newer) **release** files must be already loaded in the following path; NMS-HOME/swdownload

The file properties consist of required file keys and their names. The names are OS release files and their required resources, if any. The required file keys vary according to the specific device type.

In using the Custom Software Download feature, the user selects an existing device type (new device types are not supported). The user then selects file names from the files in the above paths for each type-specific file key. See Table 3-2 for example supported device types and their required file keys.

If the Load already contains an entry for the selected device type, its file properties will be replaced by the new selections, otherwise the new entry will be added to the selected Load.

Caution: Devices will fail if the wrong file is used for the wrong purpose when downloading a new release. Standard loads have been tested for correct configurations. Moreover, software upgrades may require updating of loads in a specific sequence to ensure data configuration integrity. Custom loads are usually created and used by Network Administrators, and they must use this feature with extra caution

Note: If a Rapiert or Switchblade type is added, manual WebgenImport will have to be used to enable the release on the target devices.

TABLE 3-2 Example Device Type File Keys

Component Type	Component Category	Required File Keys
Telesis (TN) - ADSL24AE - ADSL48 - FX20 - CFC24 ^a - CFC56 etc.	iMAP	NEW_ADSL24AE_LOAD NEW_ADSL48A_LOAD NEW_FX20_LOAD NEW_CFC24_LOAD NEW_CFC56_LOAD etc.
Rapier Types	Rapier	NEW_RELEASE NEW_PATCH NEW_GUI_RESOURCE NEW_HELP

a. The CFC loads are for the cfc24univ load type. Refer to the Allied Telesis Component Specification for more details.

3.7 Log Files for Debugging the AlliedView NMS Server

This list contains log files that have useful information in debugging NMS problems; The list can be used by support to collect debugging logs if there is a problem in the NMS server.

- NMS logs (Server logs):
 - <AlliedViewNMS>/logs/* (all files in this directory)
- InstallShield Logs (Installer/Uninstaller/Key logs):
 - <AlliedViewNMS>/log.txt
- Webserver logs (Apache/Tomcat logs):
 - <AlliedViewNMS>/apache/logs/* (all files in this directory)
 - <AlliedViewNMS>/apache/tomcat/logs/* (all files in this directory)
- Database logs (MySQL):
 - <AlliedViewNMS>/mysql/data/mysql.err
- Upgrade logs (Service Packs logs):
 - <AlliedViewNMS>/Patch/logs/* (all files in this directory)
 - <AlliedViewNMS>/Patch/*.txt (all text files in this directory)
 - <AlliedViewNMS>/Patch/*.xml (all XML files in this directory)
- Client logs if available
 - <NMS client console has a save to file option>
 - <Other client logs e.g. dialog error messages>
- Others:
 - <AlliedViewNMS>/AT_revision.txt (Build release information)

3.8 Commands for the Allied Telesis Tools Submenu

Table 3-3 lists the command equivalents for the Allied Telesis Tools submenu.

TABLE 3-3 Commands for Allied Telesis Tools Submenu

Menu Name	Windows	Solaris
Admin Tool	AT_Update.bat	AT_Update.sh
Discovery Configurator	DiscoveryConfigurator.bat	DiscoveryConfigurator.sh
License Key Form	AT_LicenseForm.bat	AT_LicenseForm.sh
Uninstall	Uninstaller.exe	Uninstaller.bin
WebGen Import	AT_WebGenImport.bat	AT_WebGenImport

3.9 Status Monitoring

Starting in Release 8.0, the Status Monitoring feature allows the administrator to track the connections, processes, and overall status of the server(s) that make the AlliedView NMS,

To access this feature, select **Tools -> Status Monitoring** from the Main Menu. The main window appears, as shown in the following figure.

Using the Export Option, the user can select either Export Summary Information (all of the panels) or Export Panel Information (the current panel) and export these as:

- An html file to the browser
- A bracket-delimited, comma-separated file to the selected server.

Note: Initially, the rows are sorted by the table category but the user can change the order by clicking on the appropriate column heading.

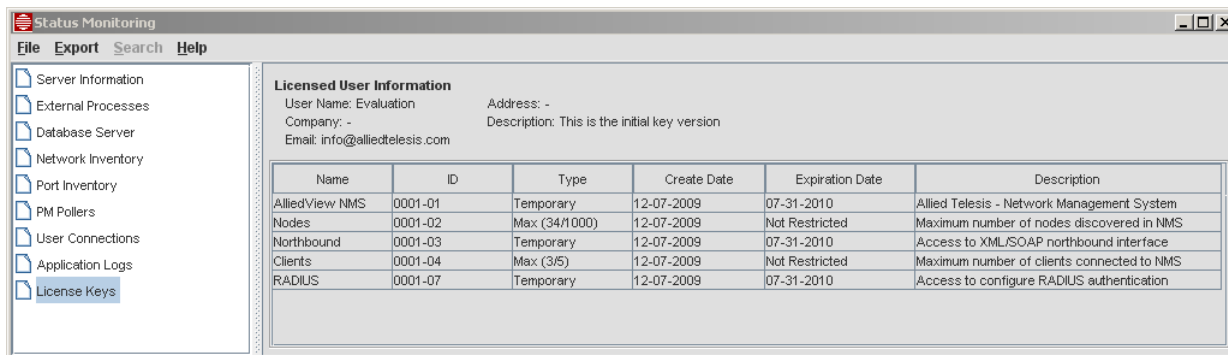

FIGURE 3-32 Status Monitoring Panel

3.9.1 Status Table

TABLE 3-4 Status Monitoring Window

Status Type	Field	Description
Server Information	Host Name	Host name of the server
	IP Address	IP address of the server
	Type	Server type (PRIMARY)
	Port	Port used for connection to the server
	State	Last observed state of the server (Up if connection working, Down server fails)
	Uptime	Time since the server was last started
	CPU Time	Total processor time used by the server since it was started
	Memory Usage (K)	Current working memory, in kilobytes
	Forwarding	TBS
External Processes	Name	Process Name
	Program Name	The executable filename
	PID	Process ID
	Usage (%)	Amount of CPU usage currently allocated to the process
	State	The last observed state of the process. The state can be: - Up – if the process is working - Down – if the process is not working
DataBase Server	Connection Information	Provides basic information about the connection to the database. - Host Name - the hostname of the machine where the database server runs. - Port - the port used for the connection to the database server. - User Name - the user name used for the current connection to the database server.
	Database Information	Provides basic information about the database used by the application. - Product - the name and version of the database server used by the application. - Driver - the name and version of the database driver used to connect to the database server. - URL - information about the URL used by the database server.
	Table Columns	Each row contains: - Name - the name of the table. - Rows - the number of rows. - Data Length (B) - the length of the data file, in bytes. - Index Length (B) - the length of the index file, in bytes. - Update Time - when the data file was last updated.
	# of Available Tables	The total number of available tables in the database

TABLE 3-4 Status Monitoring Window (Continued)

Status Type	Field	Description
Network Inventory	Table Columns	<p>Each row contains:</p> <ul style="list-style-type: none"> - Type - type of network objects. <p>Note: New network objects will be automatically added to the list.</p> <ul style="list-style-type: none"> - Discovered - the total number of discovered objects. - Managed - the total number of managed objects. - Unmanaged - the total number of unmanaged objects.
Port Inventory	Tables for iMAPs, Ports, and iMG/RGs	<p>Allows the administrator to see in one screen the total numbers of each type of iMAP, iMG/RG, and Port.</p> <p>For each port type, there is also the number of those ports that have been provisioned with a Customer ID (and should therefore be provisioned and passing customer traffic).</p> <p>The counts can also be derived from the Network Inventory tables, but using this tool provides all of the counts in one screen.</p>
PM Pollers	Summary	<p>This provides basic information about the PM Pollers.</p> <ul style="list-style-type: none"> - Total Active Polled Data - the total number of polling objects that are currently collecting statistics. - Total Number of Devices Polled - the total number of devices that have active polling objects. - Polling Interval (Shortest/Longest) - the time interval for periodic data collection.
	Column Names	<ul style="list-style-type: none"> - Host Name - the host name of the device that have active polling object. - Type - the type of the device. - IP Address - the IP address of the device. - Polled Data - the name of the active polling object. - Polling Interval - the time interval for periodic data collection. - Polling Type - the type of the active polling object. The type can be: <ul style="list-style-type: none"> - Node – if the data identifier is scalar type: - Interface – if the data identifier has many instances - Multiple – if the data identifier has multiple instances - None – if other protocol is used other than SNMP - Save Collected Data - Indicates whether the data will or will not be stored. This can be: <ul style="list-style-type: none"> - Yes – if the data will be saved - No – if the data will not be saved - Log Directly <p>This indicates if the data will or will not be stored in a text file. This can be:</p> <ul style="list-style-type: none"> - Yes – if the data will be saved to a text file - No – if the data will not be saved to a text file

TABLE 3-4 Status Monitoring Window (Continued)

Status Type	Field	Description
User Connections	Active User Connection	Displays all active user connections to the server. Each row contains: - User Name - the name of the currently connected user. - Total - the number of connections a user has currently established to the server. Selecting a user name will display the individual threads of that user in the lower box.
	User Thread	Each row contains: - User Name - the name of the currently connected user. - Host Name - the host name or IP address of the client in which the user used to connect to the server. - Type - the type of client used by the user to connect to the server. - Time - the time since the user was connected to the server.
	Telnet Sessions	This provides basic information about the CLI resources. - Total Active Connections - the total number of connections that have been established. - Maximum Number of Connections - the total maximum number of connections that can be established. - Pooling Sharing - the pooling flag common to telnet sessions. This can be: - Enabled – if the pooling sharing is enabled - Disabled – if the pooling sharing is disabled
Application Logs	Trace Log	This displays the trace logs. - Trace (Text Area) - displays the trace messages from '<installed location>/logs/trace.txt.0' file. This is a read-only field.
	Standard Log	This displays latest standard output/error log file. - Output (Text Area) - displays the standard output messages from '<installed location>/logs/nmsout.txt' file. This is a read-only field. - Error (Text Area) - displays the standard error messages from '<installed location>/logs/nmserr.txt' file. This is a read-only field.
	Server Log	This displays latest standard output/error log file. - Output (Text Area) - displays the standard output messages from '<installed location>/logs/nmsout.txt' file. This is a read-only field. - Error (Text Area) - displays the standard error messages from '<installed location>/logs/nmserr.txt' file. This is a read-only field.
	System Log	This displays the syslog.txt file

TABLE 3-4 Status Monitoring Window (Continued)

Status Type	Field	Description
License Keys	Name	Name of the License Feature.Up to four features can be listed.
	ID	
	Type	Depending on the feature, this can mean whether the feature is temporary or has a certain limit
	Create Date	When the feature was installed
	Expiration Date	When the feature expires or Not Restricted (permanent)

3.9.2 Menu Options (Export)

The Export menu item has the following options:

- **Export Summary Information** - This is a summary report of all the areas of Status Monitoring.
- **Export panel Information** - This is what appears in the panel that is currently being viewed. The one exception to this is for Application logs, where there is a pull-down to select the type of log, as shown in the following figure.

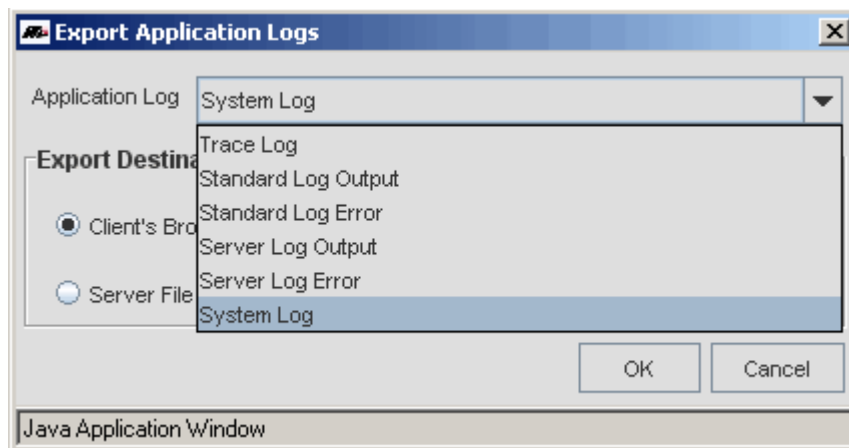

FIGURE 3-33 Selecting Type of Logs for Export

- **Archive Logs** - This is an archive file that contains all log types and can be filtered by date.

The administrator then has the option to view the data in a local browser or to export the data by selecting the Browse button to provide a filename and file type what will be placed in the Status directory.

3.10 Downloading Device Files

3.10.1 Overview (Standard versus Custom Loads)

Device loads that are transferred to the NMS and then loaded onto devices are in two main types:

- Standard load - This is usually a set of device loads that is pre-packaged for a release and is known to be compatible with certain NMS loads. Starting in NMS release 10.0, these are not included with the NMS software, but are available on either a CD provided by Allied Telesis or are on an FTP server that is available to Allied Telesis customers.
- Custom load - These are specific loads for a device or device type. Although NMS compatibility is not guaranteed, these are usually incremental updates and so should be compatible. These loads are available on Allied Telesis websites.

Before either type can be loaded onto devices, they must exist in the `<NMS-Home>swdownload` directory. Moreover, **the firmware and associated xml files must both be included**. The process to achieve this for standard and custom loads is as follows:

- Standard Loads
 - The Load Import tool (explained in 3.10.2), allows the user to place both the firmware and xml files into the swdownload directory in a easy to use GUI format.
 - The user can manually download the files and unzip them before placing them into the swdownload directory. This method would be used when the NMS is on a Solaris platform.

Note: For the manual download, ensure that the files are unzipped only once.

- Custom Loads - The user must download the files manually, and then use the Create Custom Load option that is part of the Software Configuration application (refer to 5.3.10).

Refer to the following figure that shows the steps that are followed.

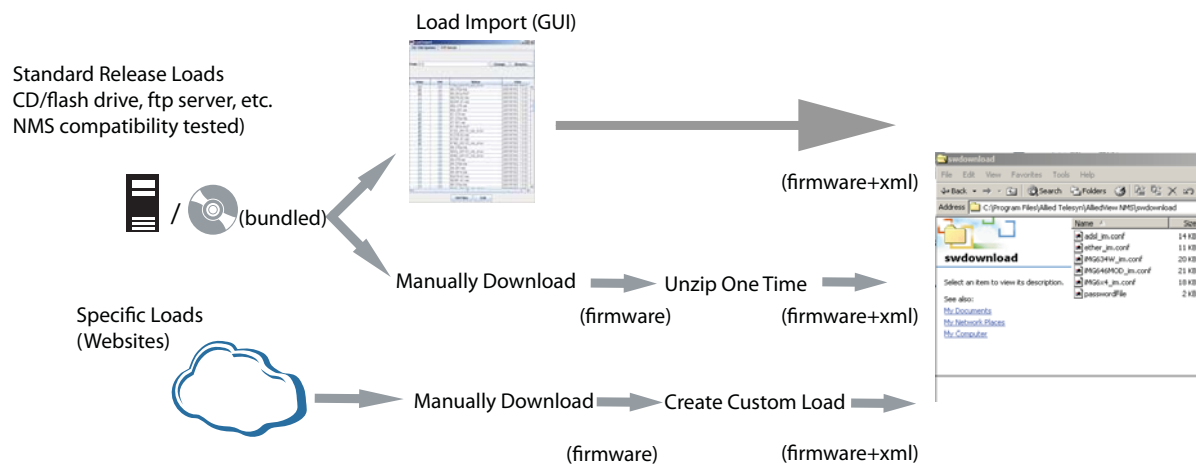

FIGURE 3-34 Download Overview

3.10.2 Load Import GUI (Standard Loads)

In release 10.0, a tool to upload of firmware bundles is added to the NMS server bin directory.

To run the tool on Windows:

- double-click on `AT_FwLoadImport.bat`

To run the tool on Solaris:

- execute `AT_FwLoadImport.sh`

The tool can be used to load firmware into the NMS from either a CD (or file system) or an FTP server. The tool displays a list of files available for download, their timestamps, and whether or not they're already loaded into the NMS. By checking the “Get” boxes, files can be selected for download. The **Get Files** button will load the selected files into the NMS. Loading progress is displayed in a popup window and zip files are unzipped as they're loaded.

Use the tab at the top to select a CD / File System download or an FTP Server download.

The CD / File System tab contains a Path field where a directory path can be entered. Either enter carriage-return or click the **Change** button to get a list of files available in that directory. Use the **Browse** button to popup a directory browser to point-and-click directory changes. Doubling-clicking will change the directory, update the file list, and leave the browser displayed so further directory changes can be selected.

The FTP Server tab also contains Host, Username, and Password fields to designate the FTP server and login credentials. The **Connect** and **Disconnect** buttons allow logging in and logging out of the FTP server. An initial directory can be entered into the Path field before connecting. Then once logged in the tool will immediately change to that directory. Further directory changes can be made the same way as in the CD / File System tab. Since FTP is remote, there may be delays updating the file listings with each directory change.

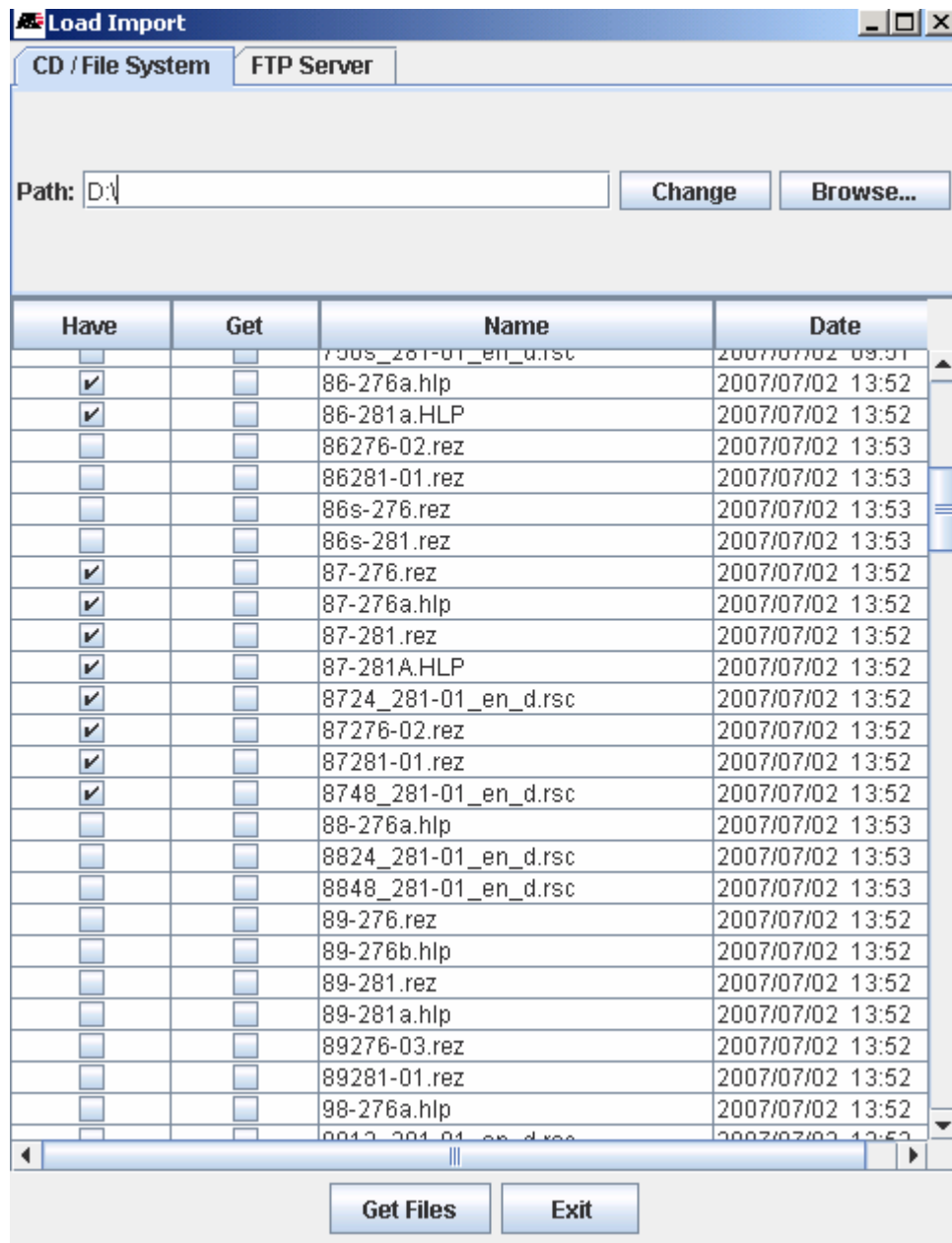

FIGURE 3-35 Load Import for CD/File System

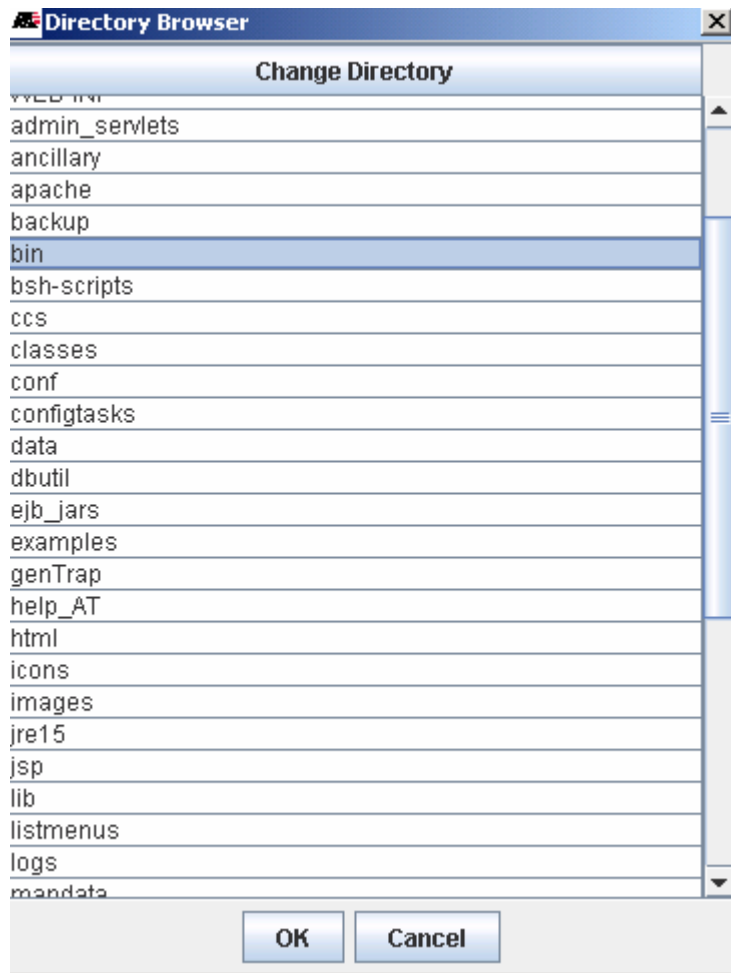

FIGURE 3-36 Changing Directories for Browsing

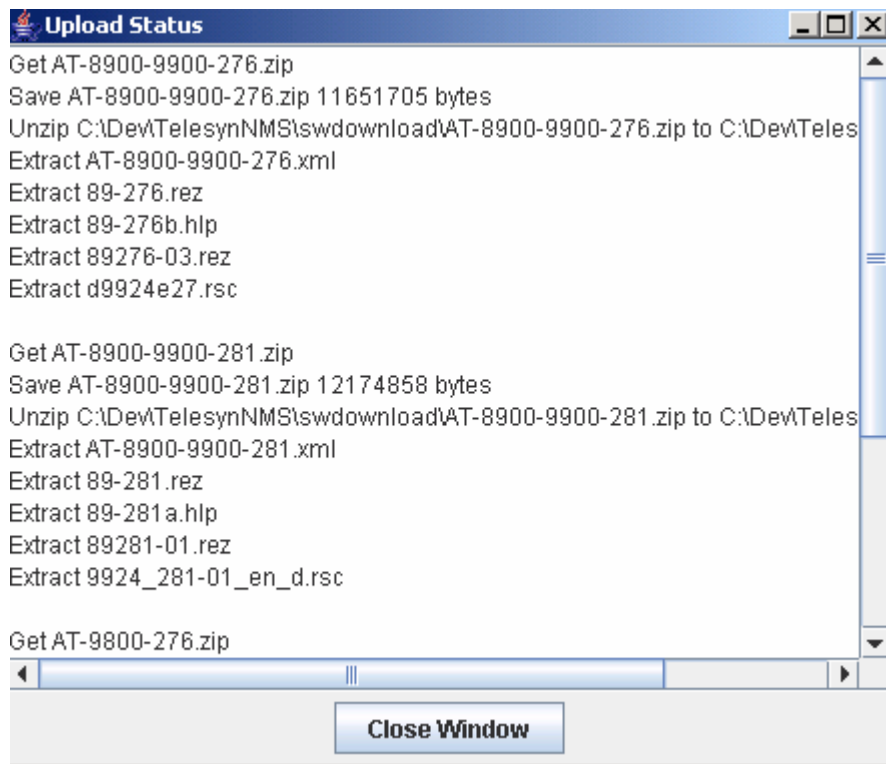

FIGURE 3-37 Upload Status as Getting Files

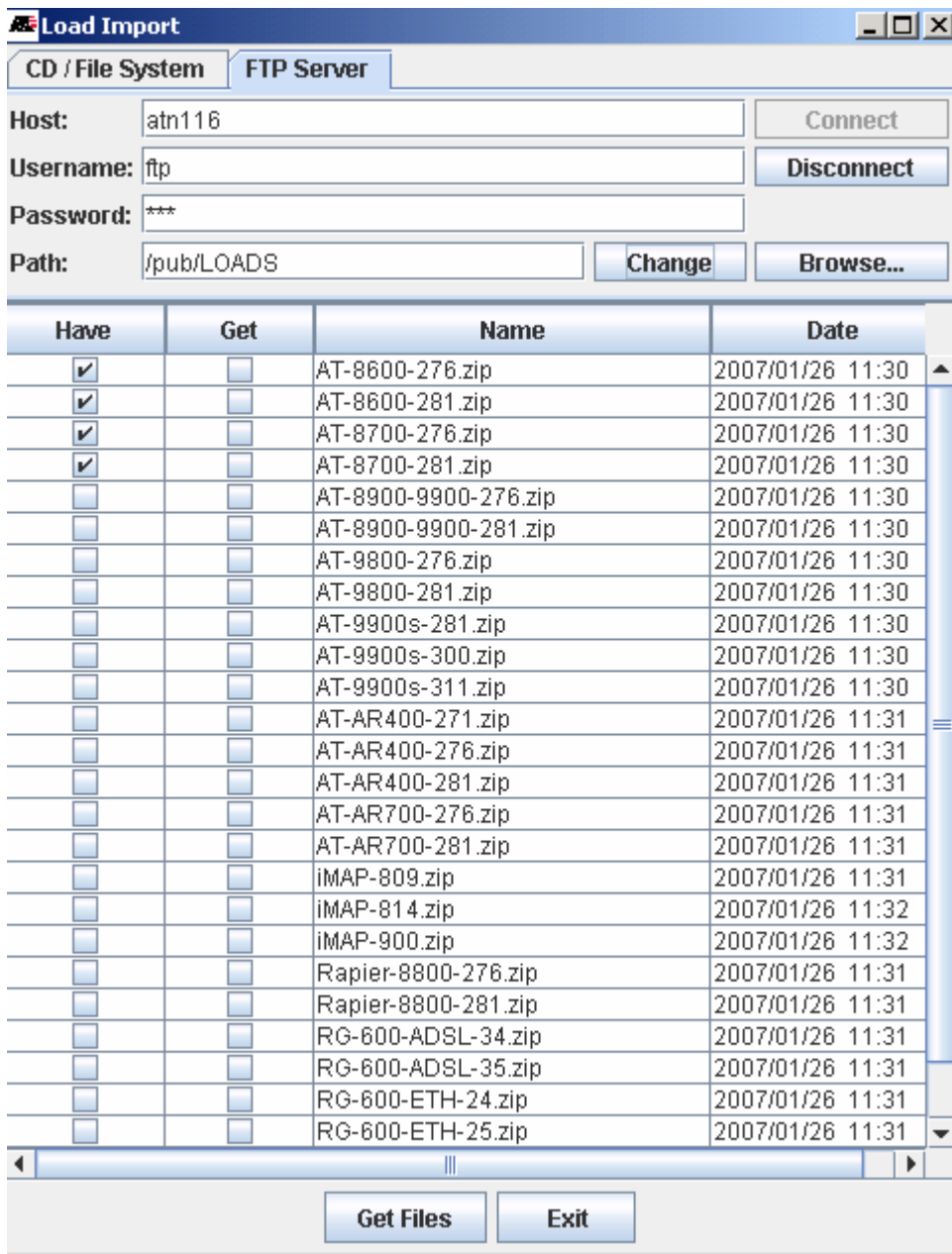

FIGURE 3-38 Load Import Tool for ftp Server

3.11 Accessing the NMS Database

The database used is MySQL. To access the database use the following:

username=guest / password=public

Contact Professional Services for more information.

4. Security Administration

4.1 Overview

Administrators can configure security settings by accessing Security Administration. Security levels are achieved through the creation and defining of **Users** and **Groups**. Levels of access are defined in terms of what nodes can be viewed and what operations can be performed.

Administration tasks are performed using the Security Administration wizard, which is invoked by clicking the **Tools --> Security Administration** menu item. The following figure appears.

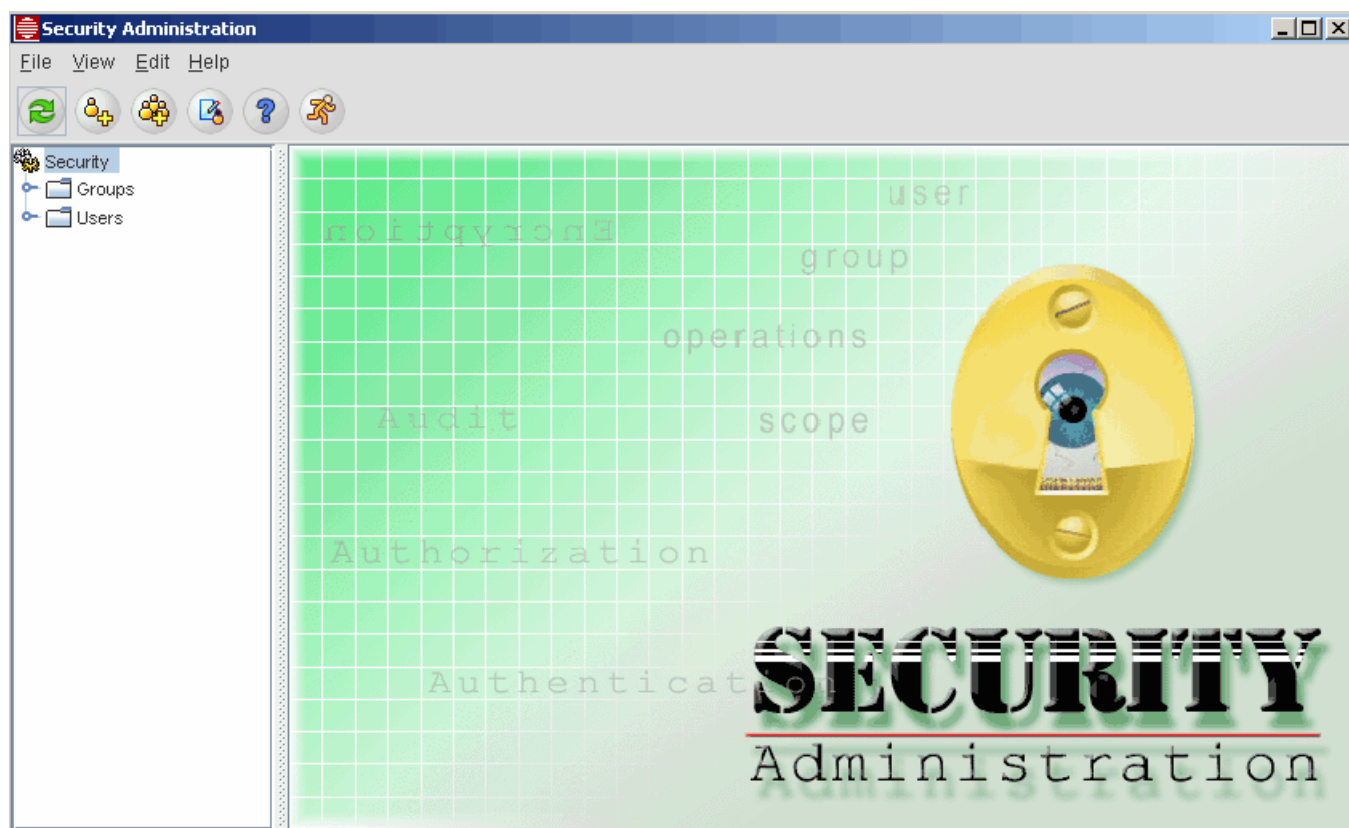

FIGURE 4-1 Security Administration – Main Display

Use the following table to locate the task you wish to perform. If you are using NMS, use the screen or form name you are seeing to locate the relevant section.

TABLE 4-1 Task List for Security Administration - User

Task	Screen / Form Name (if Applicable)	Section
Add User	User Wizard	(4.2)
Configure User - Associate Groups - User Profile - Audit Trails - Change Password - Assign Operations - Delete	Select Groups User Profile Tab Audit Trails for User Tab Permitted Operations for User Tab	(4.3.2) (4.3.3) (4.3.4) (4.3.5) (4.3.6) (4.3.7)
Add Group	Groups Wizard	(4.4)
Configure Group - Set Scope - Associate Users - Assign Operations	Scope Settings Select Users Wizard Operations Tree	(4.4.1) (4.4.2) (4.4.3)
Custom View Scope (CVS) - Overview - Add Authorized Scope - Set Authorized Scope for CVS - Set Scope Properties - Delete Authorized Scope	Custom View Scope for Group Tab Scope Settings Select Authorized Scopes Scope Setting Wizard	(4.5.1) (4.5.2) (4.5.3) (4.5.4) (4.5.5)
Operations Tree - Overview, Add / Delete - Default Operation Categories	Operation Tree Configuration	(4.6.1) (4.6.2)
Remote Authorization (RADIUS / Tacacs+)		(4.7)
NMS RADIUS Client Support	RADIUS Configurator GUI	(4.8)

4.2 Add a New User

For adding a new user you can follow any one of the options.

- Choose the **File** menu from the menu bar and select **New** under which you can select the option AddUser.
- Click the **Add User** icon in the Toolbar
- Right-click the node named **Users** in the left-side tree, which is a parent node.

This brings up the following figure, the **User Administration** wizard.

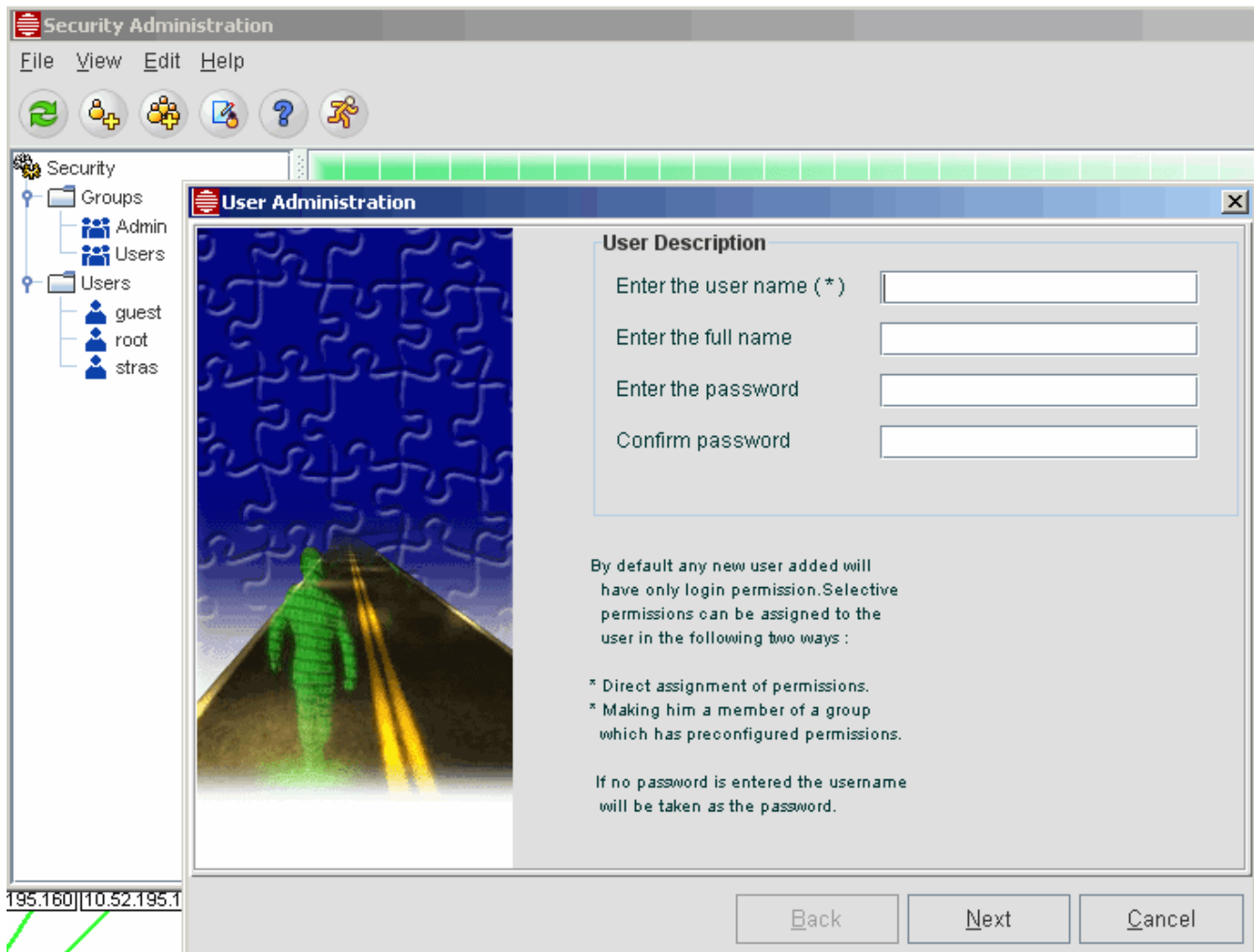

FIGURE 4-2 User Administration Wizard (1)

The User Administration Wizard invoked prompts you to enter the username and the password for the user in the corresponding text boxes.

Note: The screen has a reminder that if no password is supplied, the password is the username.

Click **Next** to move to the next screen, which is shown in the following figure.

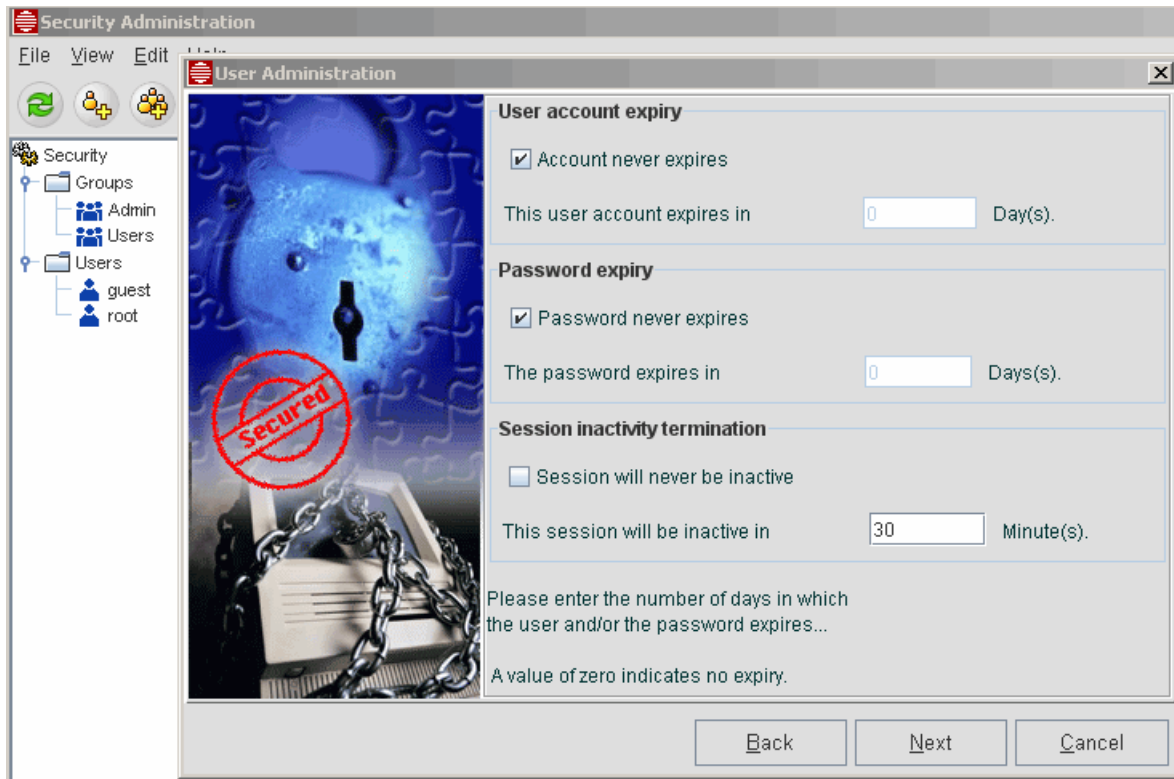

FIGURE 4-3 User Administration Wizard (2)

This **User Administration** screen shows the user account and password expiry in number of days. By default both values will be zero indicating that the user account and password never expire. If you need to set an expiry date for user account and password, uncheck the corresponding check boxes, and then enter the expiry period in the number of days.

The Session inactivity termination panel can activate the session timeout feature, by clicking on the Session Timer checkbox to make it not ticked (default is ticked), and then entering a value (in minutes).

After setting the user account expiry and password expiry time, the last screen of the User Administration Wizard, which is invoked by clicking **Next**, is where you can assign groups to the user or operations to the user directly. Refer to the following figure.

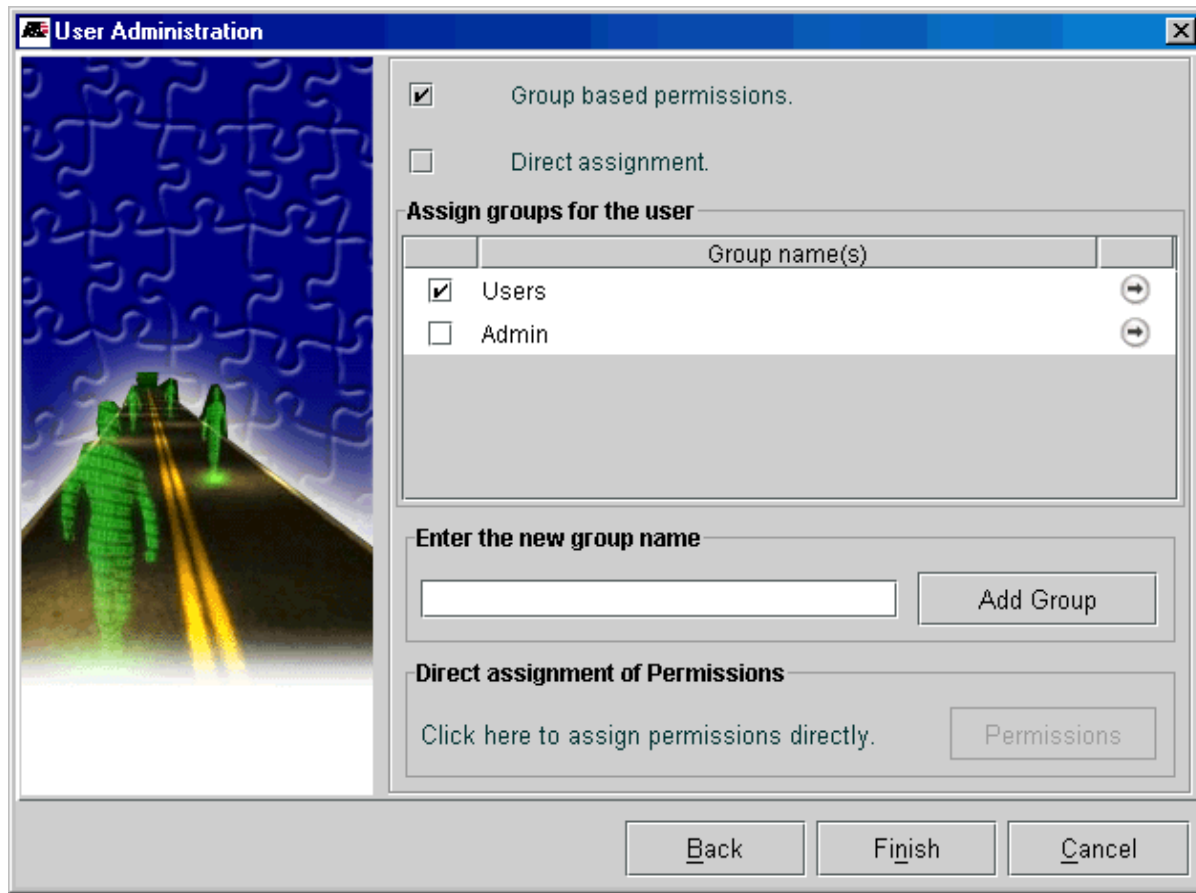

FIGURE 4-4 User Administration Wizard (3)

Users can be associated with existing groups by clicking the appropriate check boxes of the groups when the checkbox **Group based permissions** is checked. You can also see the allocated operations for the existing groups by clicking on the right arrow for that group.

Note: You can associate the new user to a new group by entering the new group name in the corresponding text box and clicking **Add Group**. The group is added and the operations for that group can be defined immediately. In most cases, however, a group should be defined first and then users associated with that group.

To assign operations to the user directly without associating him or her with any groups, check **Direct assignment**. The **Permissions** button is activated, and the Administrator can assign operations to a user without associating them to any groups. Clicking **Permissions** will invoke the Permissions Tree Hierarchy. The Administrator can use this operations tree to allow/disallow operations for that user.

You can assign permissions by:

- Checking (checkmark) the check boxes to include the operations
- Ticking the check box (x) to exclude operations
- Leaving the check box empty so that it inherits its parent operation permission

Note: Repeatedly clicking the checkbox will cycle the checkbox through these states (checkmark, x, empty).

After associating groups to the new user, click **Finish** for confirmation. If you need to make any changes, you can go back to the previous screens by clicking **Back** and make the necessary changes. The new user added will be displayed under the left side tree under the parent node **Users** in the main **Security Administration** window.

4.3 User Settings

4.3.1 Overview

For performing user-level tasks, select the particular user in the left-side tree of the main **Security Administration** window under the parent node **Users**.

4.3.2 Associating Groups to User

After selecting the particular user, click **Setting Groups** in the lower right corner of the **Member Of** panel to associate the user with any of the existing groups or to remove the user from the already associated group, as shown in the following figure.

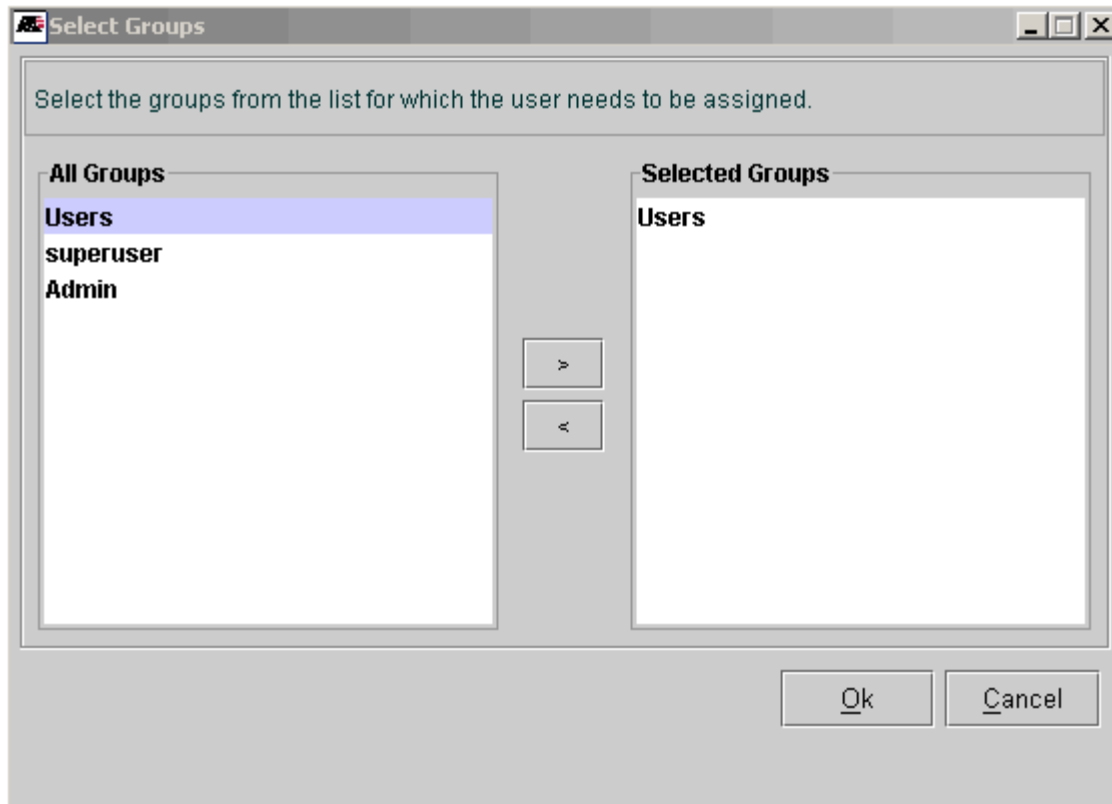

FIGURE 4-5 Associating Groups to User

In the left-side list are the existing groups and in the right-side list are the group names to which the user has already been associated. You can select the particular group from the left side and click the > (Add) button to associate the new group to the user. For removing the user from the already associated group, select the group in the right side from which the user needs to be removed and click the < (Remove) button.

4.3.3 Setting User Profile

To modify the user details select the particular user and click on the **User Profile** tab, which will display the current user status, user account, password expiry in number of days, and the session inactivity termination for the user, as shown in the following figure.

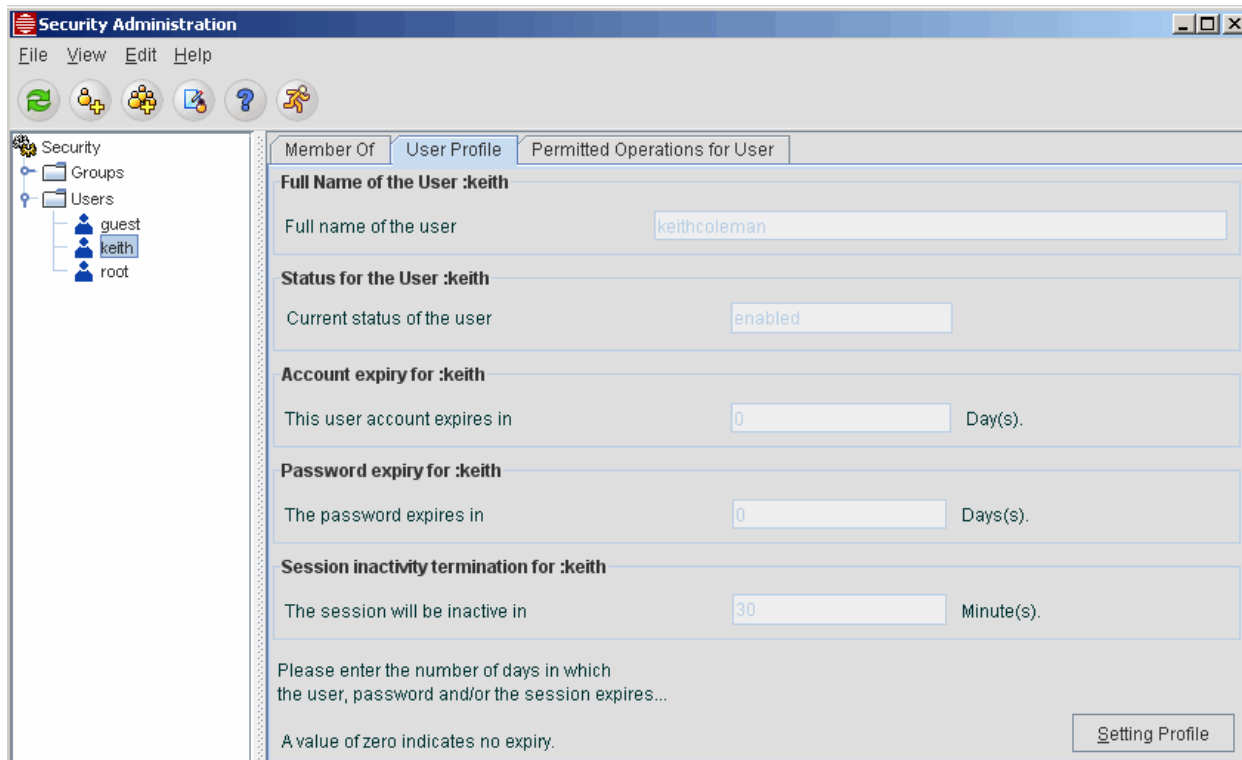

FIGURE 4-6 Setting User Profile

The Security Administration tool has the provision to display the current status of the users using separate icons for different user status as shown in the left-side tree under the **Users** node. The various user status reflected in the User Interface (UI) are shown in the following table.

TABLE 4-2 Icons for User Status

Icon	Description
	User Account is enabled
	User is disabled and he cannot login any more until he or she is enabled by the administrator
	User account has expired since the specified
	User Password has been expired since the specified time and he or she has to change his password or reuse it
	User account has been forced out from logging in to the server similar to the disable status of a user
	User's login has been denied due to continuous unsuccessful login attempts

Click **Setting Profile**, which will invoke the User Profile Wizard where you can set the user account expiry in days by clicking the corresponding check box. After the account expiry period, the status of the user is disabled and the user will not be allowed to log in on the network. Similarly, the user password expiry can be set in number of days, after which the user is prompted to enter a new password. Finally, you can change the session inactivity timer. You can also set the user status as either enable or disable by clicking the respective option. Refer to the following figure.

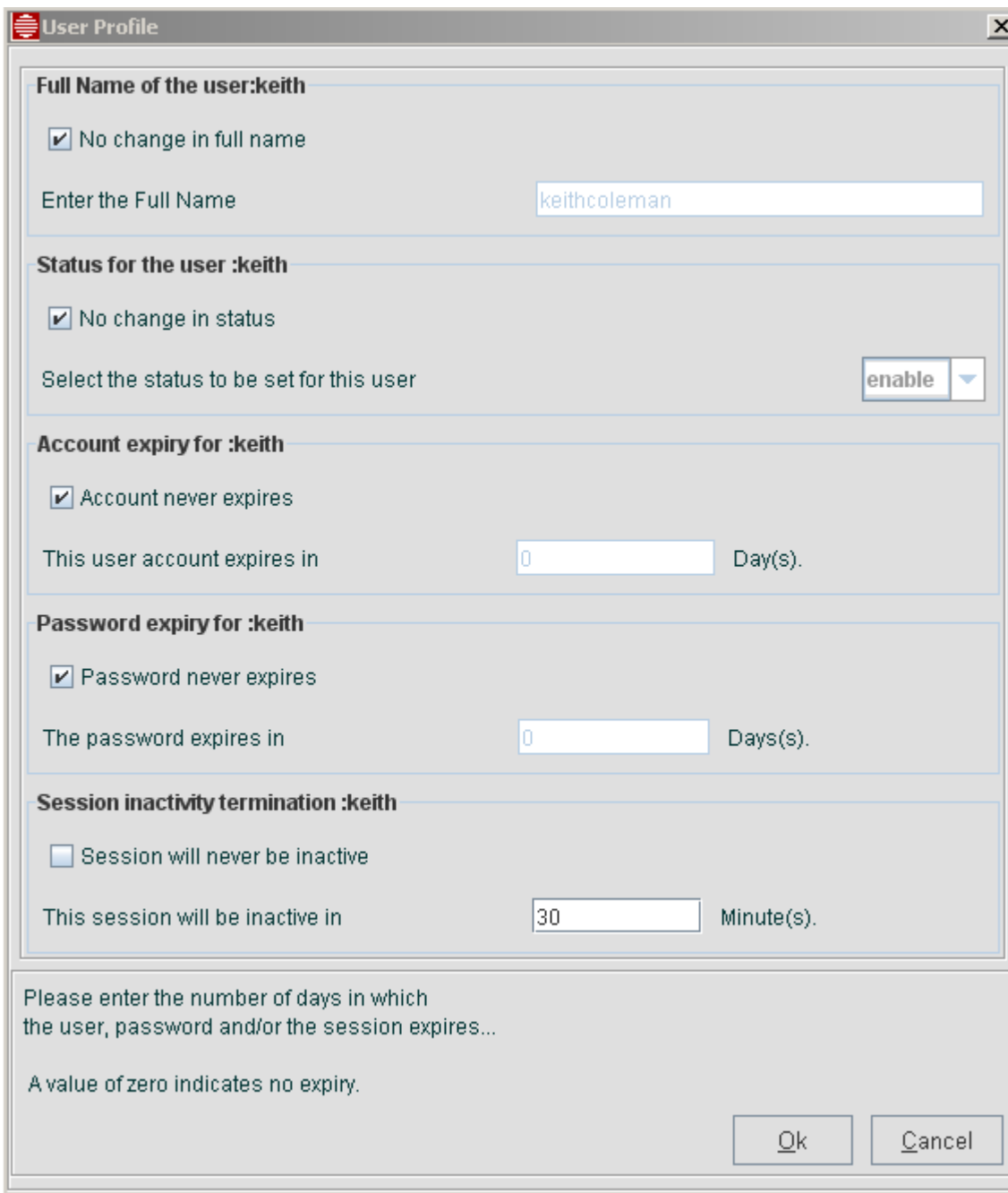

The image shows a 'User Profile' dialog box for user 'keith'. It is divided into several sections:

- Full Name of the user:keith**: A checked checkbox for 'No change in full name' and a text input field containing 'keithcoleman'.
- Status for the user :keith**: A checked checkbox for 'No change in status' and a dropdown menu set to 'enable'.
- Account expiry for :keith**: A checked checkbox for 'Account never expires' and a text input field with '0' followed by 'Day(s)'.
- Password expiry for :keith**: A checked checkbox for 'Password never expires' and a text input field with '0' followed by 'Days(s)'.
- Session inactivity termination :keith**: An unchecked checkbox for 'Session will never be inactive' and a text input field with '30' followed by 'Minute(s)'.

At the bottom, there is a note: 'Please enter the number of days in which the user, password and/or the session expires... A value of zero indicates no expiry.' and two buttons: 'Ok' and 'Cancel'.

FIGURE 4-7 User Profile Wizard

After making the necessary changes click the **Ok** button for updating the server.

4.3.4 Viewing Audit Trails

The audit trails of all the users can be viewed by selecting the **View -> Audit Trails** menu or clicking the **Audit Trails** icon. This displays the **Audit Details** window where the various operations performed by the users along with the status whether the operation was a success or failure are displayed. Refer to the following figure.

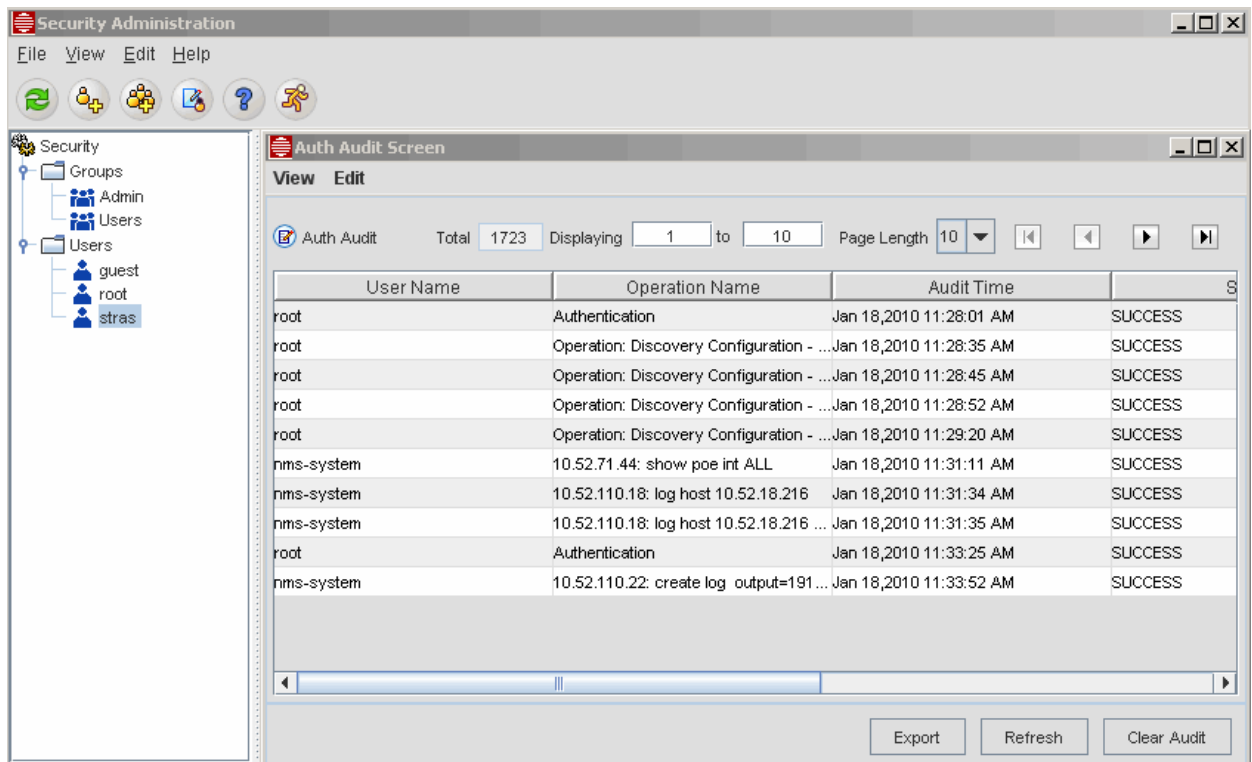

FIGURE 4-8 Audit Trail Details - File

You can save the audit details in a file for future reference to identify any access violation. To clear all the previous audit details, click **Clear Trails**.

Note: Actions such as command input for a device can also be recorded by the SYSLOG application; the benefit of the Audit is that it shows commands that were invoked using the NMS as well as the user who invoked the command.

4.3.5 Change the User Password

For a selected user you can change the password by right-clicking and selecting the **Change Password** option from the pop-up menu, or by selecting **Edit -> Change Password** from the menu of the **Security Administration** window.

This displays the **Change Password** window, which has text boxes in which the new password can be entered and confirmed. After entering the new password and confirming it, click **OK** for the respective change.

4.3.6 Assigning Operations to User

Click the **Permitted Operations for User** tab after selecting the particular user for whom you want to assign operations. This shows the already included and excluded operations for the respective user. In order to assign new operations, click **Set Permissions**. This invokes the operations tree as shown in the following figure.

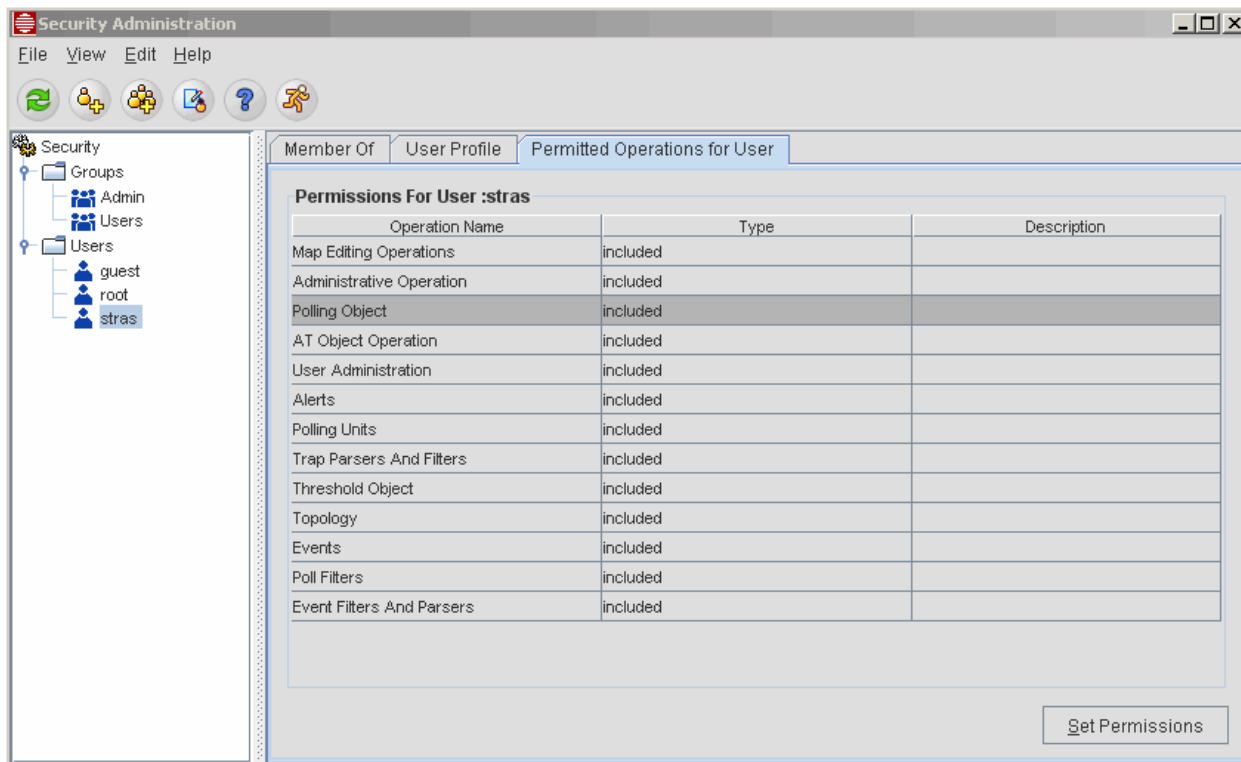

FIGURE 4-9 Permission Tree Hierarchy

The operations tree is a union of the operations included or excluded of the groups and the directly assigned operations. Thus you can assign permissions to the operations that are not associated with the group for the user. In order to modify the permissions set to the user through groups, go to the **Permitted Operations For Group** tab after selecting the particular group, and then click **Set Permissions** to do the necessary changes. In the operations tree, by clicking the respective check boxes of the operations, you can include that operation for the user, and by ticking the check box (x), you can exclude that respective operation for the user. After making the necessary selections click **Done** to make the change permanent.

You can assign permissions by:

- Checking (checkmark) the check boxes to include the operations
- Ticking the check box (x) to exclude operations
- Leaving the check box empty so that it inherits its parent operation permission.

4.3.7 Delete User

To delete a user, right-click the user and select **Delete** from the pop-up menu, or select **Edit -> Delete** option from the menu of the **Security Administration** window. This deletes the user and all his or her associated operations and groups.

4.4 Adding a new group

In the **Security Administration** window, you can add a new group by performing one of the following actions:

- Select **File -> New -> AddGroup** from the menu bar.
- Click the **Add Group** icon from the Toolbar.
- Right-click the node **Groups** in the left-side tree, which is a parent node.

Each of these actions invokes the **Groups wizard**, shown in the following figure, where you can enter the new group name in the text box.

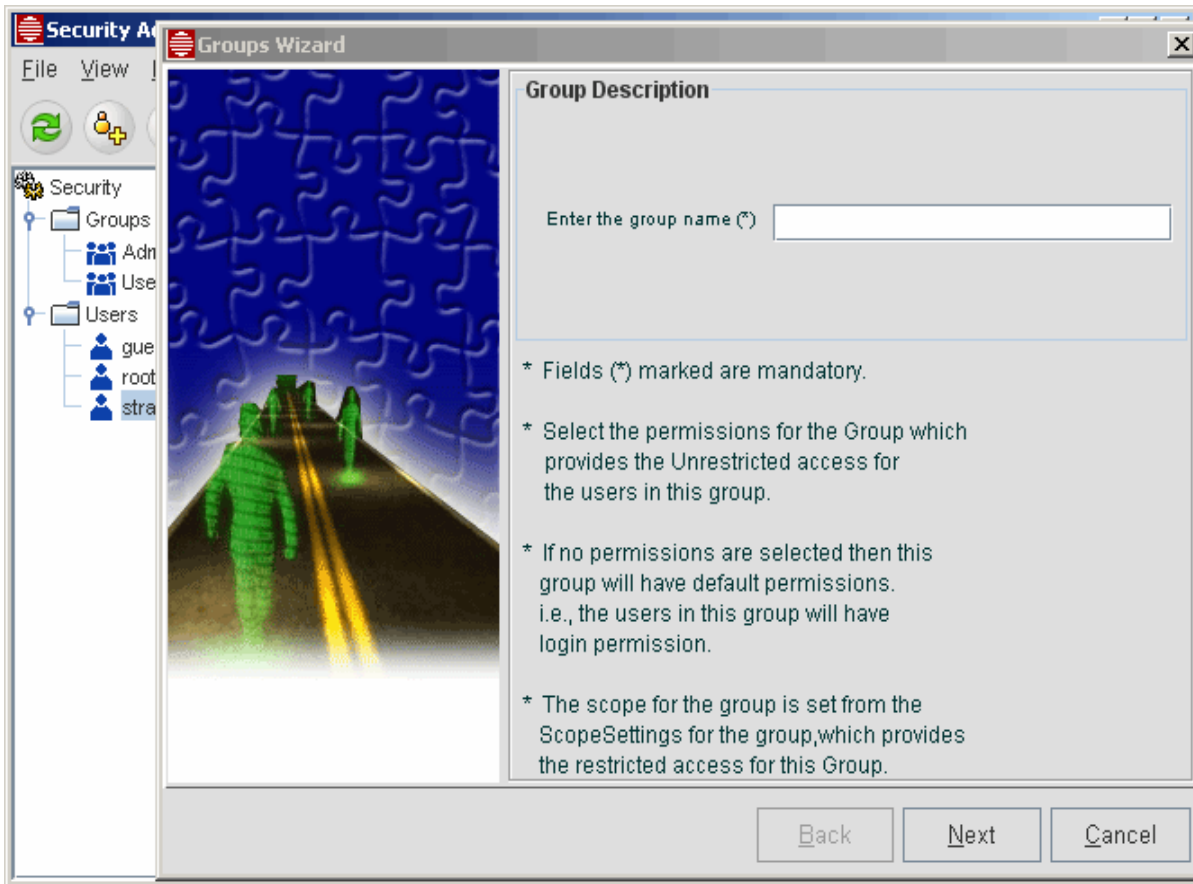

FIGURE 4-10 Groups Wizard (1)

After entering the group name, click **Next**, which invokes the second screen of the Groups Wizard, as shown in the following figure.

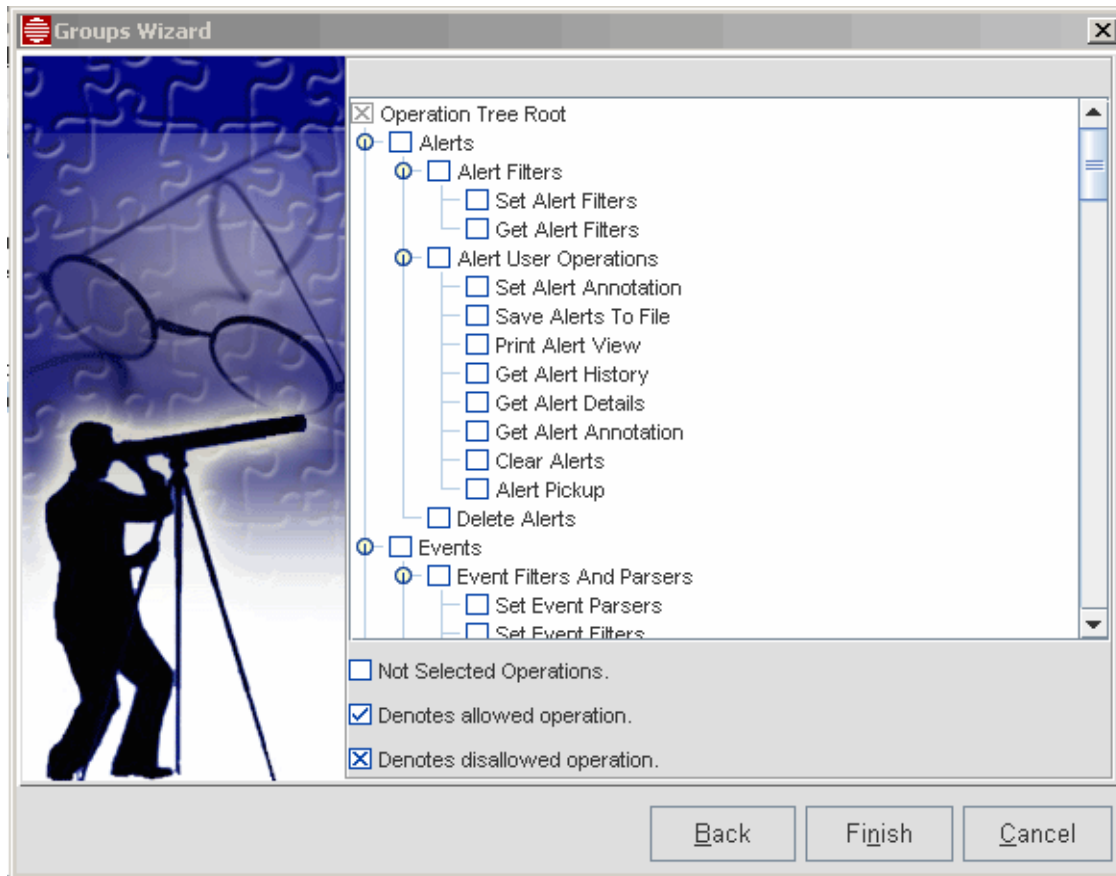

FIGURE 4-11 Groups Wizard (2)

You can assign operations for the group by:

- Selecting (checkmark) the check boxes to include the operations
- Ticking the check box (x) to exclude operations
- Leaving the check box empty so that it inherits its parent operation permission.

After selecting the operations, click **Finish** to saving the changes permanently in the server.

4.4.1 Group and Scope Settings

4.4.1.1 Overview

Authorized Scopes (or Authorized Views) are independent entities that store the real authorization information. The scopes are associated with the actual operations of the group leading to a more specific authorization for the user. Scopes consists of a set of properties, and the scope is applicable only when those properties are true. For example, if you give a property as network=192.168.4.0, the scope of that associated operation is applicable only for this network. The Scopes associated to the respective operations are grouped together under the groups and then allocated to the users. The Administrator can perform the following tasks under Scope configuration.

4.4.1.2 Add a Scope

Select a particular group for which you want to set a scope for the operations under that group, and then select the **Permitted Operations for Group** tab in the **Security Administration** window. Now select the operation for which you wish to set a new scope, and then click **Setting Scope**. This invokes the Scopes Settings Wizard, which helps in adding a new scope, as shown in the following figure.

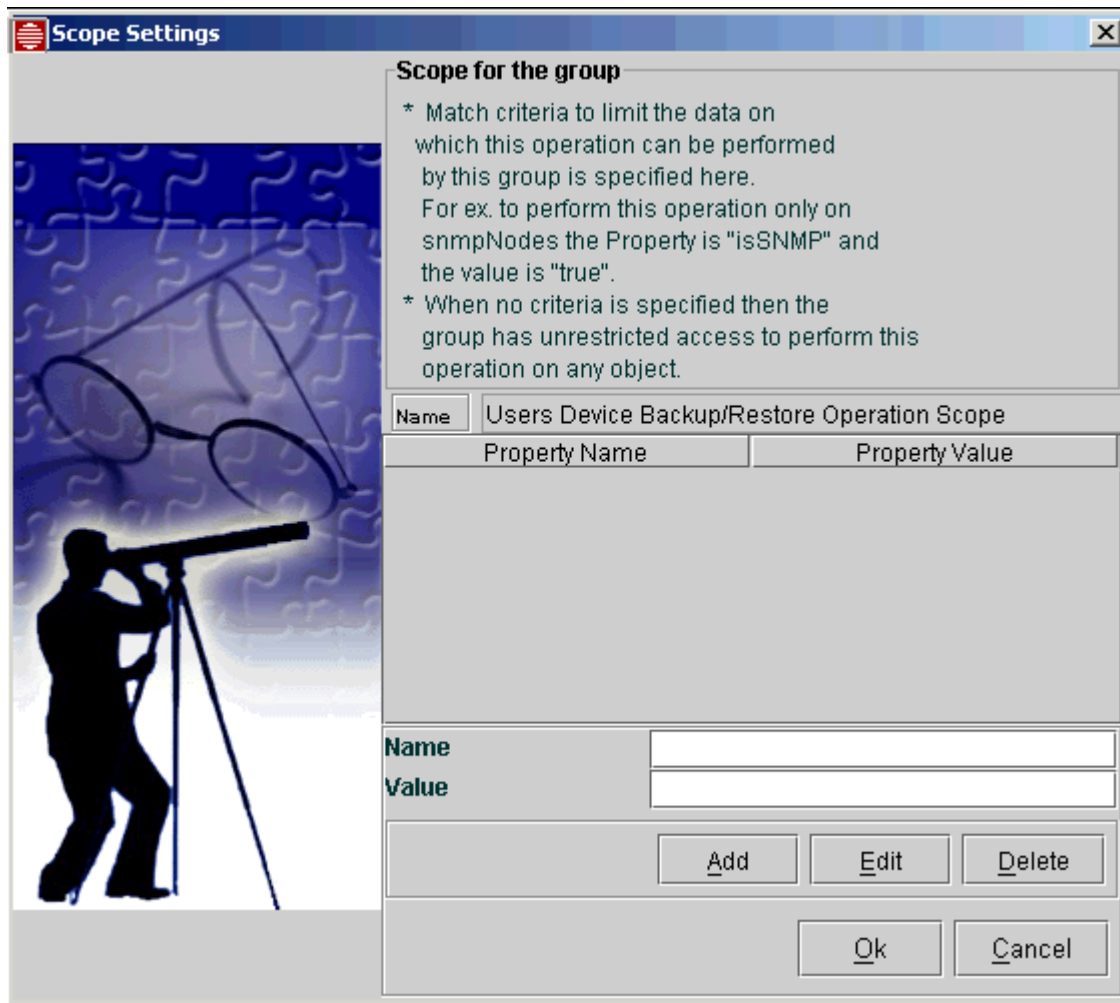

FIGURE 4-12 Scope Settings

To add a new scope, perform the following:

- Give the property name and property value for the selected operation scope.
- Click **Add** in the wizard.
- Click **Ok** to save the changes and to exit.

4.4.1.3 Edit a Scope

To edit a scope, select it and click **Edit**. The inputs given for the respective operation's scope that can be edited are Property Name and Property Value.

4.4.1.4 Delete Scope

To delete a scope, select the respective Property row of the scope to be deleted, and then click **Delete**.

Note: Scopes can be configured to Operations of Groups with properties. The Administrators can add a list of scope to a single operation or more of the groups and then assign the group to the users. Properties are then added for more specific authorization.

4.4.2 Assigning Users to Group

Users can be assigned to the group by selecting the particular group from the left side of the **Security Administration** window under the parent node **Groups** and in the **Members** tab screen in the right, click **Setting Users**. This invokes the Select Users Wizard where you can see all the user names in the left-side column and the selected users for the particular group in the right-side column. Between these two columns are the **Add** and **Remove** buttons by which you can select a particular user and either add the user to the group or remove the user from the group.

4.4.3 Assigning Operations to Group

To assign operations to the group, select the particular group and click the **Permitted Operations for Group** tab in which you can click **Set Permissions**. This invokes the operation tree where you can allow or disallow operations for that group by clicking the check boxes of the respective operations, and then clicking **Done** to make the changes permanently in the server and to exit the operations tree. Thus, the tasks under the Group Settings are performed.

4.5 Custom View Scope (CVS)

4.5.1 Overview

Setting Custom View Scope for groups of users helps in filtering the objects that are to be displayed in the user's GUI on which the user is permitted to do the respective authorized operations. By specifying the custom view scope criteria, the user can view only the objects for which he or she has been authorized to operate on by filtering the objects.

For the particular group the various Custom View Scopes assigned can be viewed, new Authorized Scopes can be added, and already existing Authorized Scopes can be edited for the selected CVS of the group by using the options available in the **Custom View Scope for Group** tab in the right as shown in the following figure.

Note: Any changes to scope take effect the next time a user (or a user in a group) logs in. Also, a user in multiple groups will be filtered according to the most restricting scope of each category of all groups.

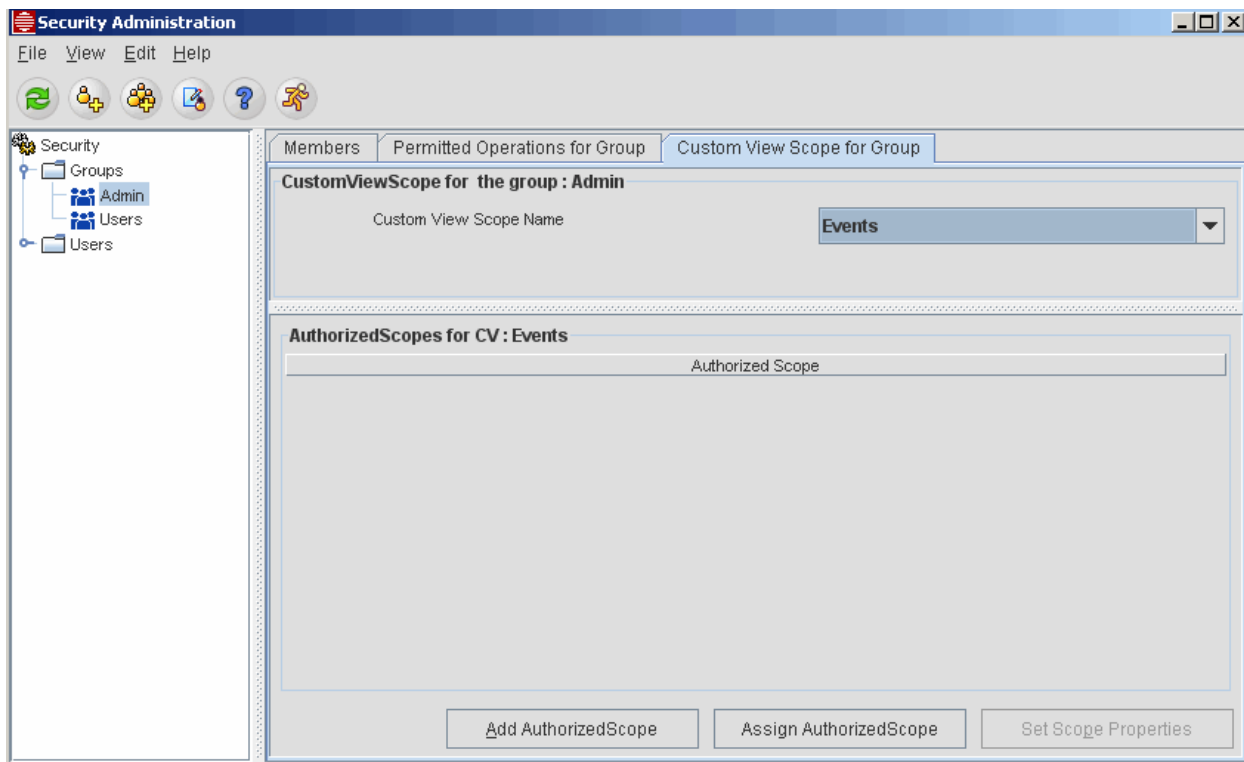

FIGURE 4-13 Custom Scope View

Following are the list of tasks that can be done for the selected Custom View Scope of a group.

4.5.2 Add Authorized Scope for a Custom View Scope

Generally Custom View Scopes are added through the group and scope settings. To add authorized scope to the available Custom View Scope of the group, select the relevant Custom View Scope Name and click **Add AuthorizedScope**, which will invoke the **Scope Settings** form.

In the **Scope Settings** form, enter the Authorized Scope Name in the respective text box, and then enter the required Name and Value for the property of the scope. The Administrator can give more than one value as comma-separated property values for a property name. Now, click **Add**, which adds the Authorized Scope for the selected Custom View Scope of the group, and then click **Ok** to make the change permanent.

4.5.3 Set Authorized Scope for a Custom View Scope

In order to set Authorized Scope for the selected Custom View Scope of the group, click **Set AuthorizedScope**. This will invoke the **Select AuthorizedScopes** screen, in which the left-side column displays all the AuthorizedScopes set for the operations of the groups, which are already present, and the right-side column displays the previously set Authorized Scopes or the selected Custom View Scope name. Thus, you can select the respective scope to be set for the custom view in the left and click > (Add). To remove the already existing authorized scope set for the Custom View, select the respective scope in the right side column, and click < (Remove) button. Click **OK** to save the changes permanently in the server.

4.5.4 Set Scope Properties

To set properties to the Authorized Scopes of the Custom View Scope, select the respective row of the Authorized Scope and click **Set Scope Properties**. This button invokes the Scope Settings Wizard where you can set the necessary properties for the selected Authorized Scope.

This operation is similar to the tasks discussed above in the Scope Configuration section. The below table helps you to know the wild card characters that are supported in NMS while specifying the scope criteria value.

TABLE 4-3 Operators for Setting Scope Criteria

Operator	Description
* (Asterisk)	This is used to match zero or more characters. <i>Example:</i> If the names of all the objects starting with the name “test” is needed, then the property Name - name and the Value test* is given.
! (Exclamation Mark)	This is used for filtering the search using NOT operator. <i>Example:</i> If all the objects whose name does not start with “test” is required, then property key - name and value - !test* is given.
, (Comma)	This is used for searching objects where a single property key has different values. <i>Example:</i> If all the objects with names starting with “abc” or “xyz” are required, then property key - name and value “ abc*,xyz* ” is given
&&	This is also used for searching objects where a single value should be matched with many patterns. <i>Example:</i> If all the objects with names starting with either “abc” and ending with “xyz” are required, then property key - name and value “ abc*&&*xyz ” is given.

TABLE 4-3 Operators for Setting Scope Criteria

Operator	Description
\ (Back Slash)	This is used when the name of the object itself contains a comma. This character is called an escape sequence, since it avoids searching of the objects, as if it were two different names. <i>Example:</i> If an object with name “a, b” has to be searched, then the property key - name and the value - “ a\, b ” is given. <between>”value1” and “value2” This is used to get objects with some numeric values within a specific range.
<between>”value1” and “value2”	This is used to get objects with some numeric values within a specific range. Example: If object names with poll interval values ranging from 300 to 305 are required, then the property key - pollinterval and the value as 300 and 305 is given. Note that the first number is smaller than the second number. Only the values in between the given values, including the limits, will be matched.

4.5.5 Deleting Authorized Scope

The Authorized Scopes associated to a Custom View Scope can be deleted completely from the database by right-clicking the respective Authorized Scope, and then clicking the pop-up button **Delete AuthorizedView**. This will display a warning dialog box. Click **Yes** in the dialog box to delete the view scope.

Deleting the selected Authorized Scope of the respective Custom View Scope will remove it completely, not only from the current selected group, but also from the other associated groups. Hence, in order to delete an Authorized Scope set for a Custom View Scope only from the selected group, click **Assign Authorized Scope** and dissociate it from the current selected group.

4.6 Permissions Tree

4.6.1 Overview

NMS operations are logically arranged in a tree structure, with parent and child operations in the tree. This tree is displayed when assigning permissions to a group or a user. The tree is referred to as the Permissions Tree and is shown in [Figure 4-14](#). Permission to perform individual operations can be granted or denied for each group or user through this tree.

Note: The ability to add or delete an operation is not supported in the current release.

Note: The tree node AT Object Operations includes those operations that the NMS can perform on Allied Telesis devices.

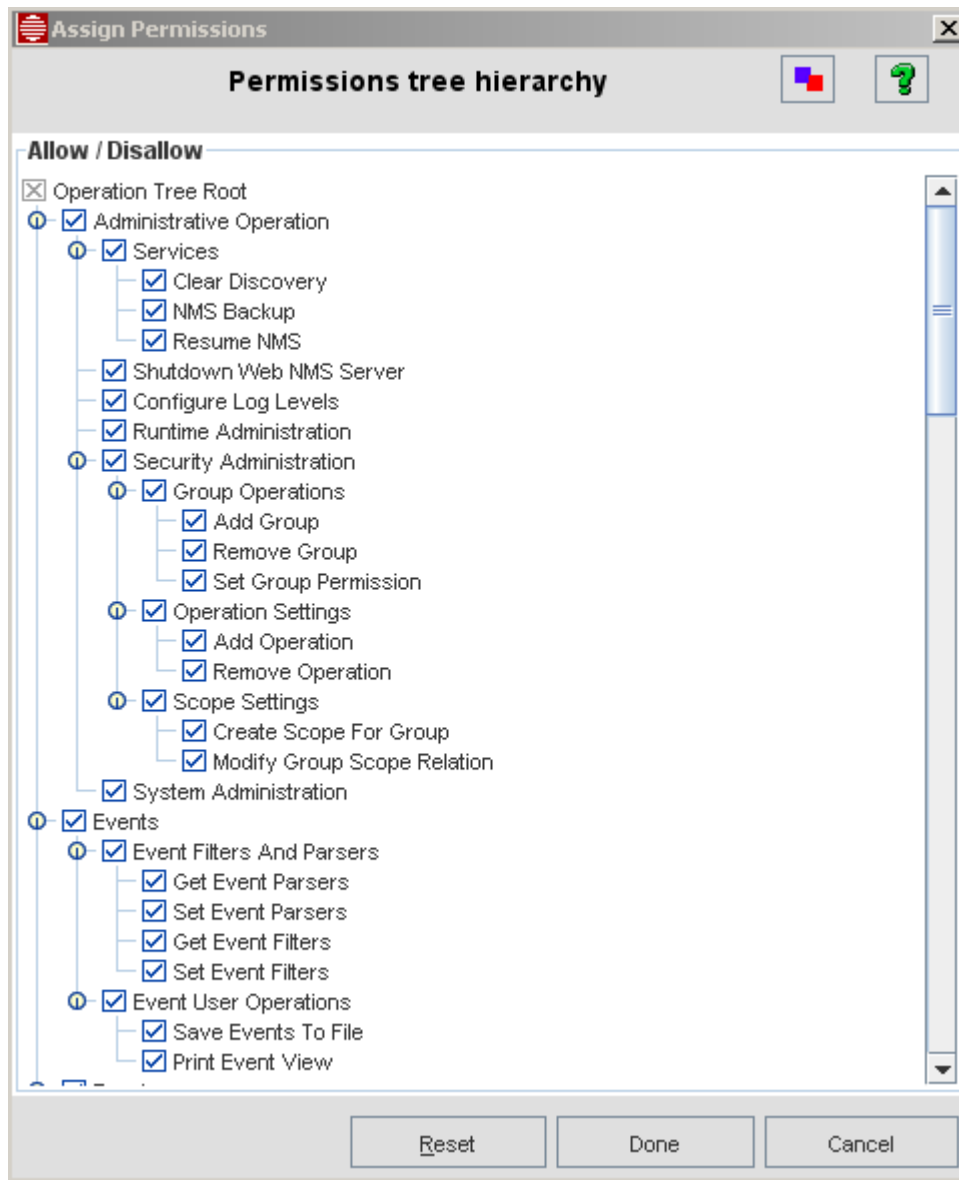

FIGURE 4-14 Permissions Tree Configuration (Includes AT Devices)

4.6.2 Permissions Tree

The Permissions Tree contains a list of operations that are provided by default in the NMS. Assigning different operations to different users is an administrative function. The different operations that can be assigned are explained in the following tables.

4.6.2.1 Administrative Operations

TABLE 4-4 Administration Operations

Operation	Description
Services	
Clear Discovery	This operation is used when the Discovery process has stopped.
NMS Backup	This Operation starts the backup process by setting BackUpInProgress variable to true and suspends all NMS Schedulers. Once the backup process is over, automatically resets the BackUpInProgress variable to false, to resume NMS Schedulers.
Resume NMS	This Operation can be used to resume all the NMS Schedulers, if NMS hangs due to some unforeseen problems during the backup process.
Shutdown server	This Operation is used for shutting down the NMS Server with authentication.
Configure Log Events	This Operation provides the link to view the present logging levels for the various modules. The logging also can be set by using this Operation.
Security Administration	Security Management involves work starting from authenticating a user when logging till dictating all permissions for him and thus defining the access limits for every user.
System Administration	This Operation is for getting the handle for all the Administrative Operations.

4.6.2.2 Events

Network Events are entities that represent the various happenings in the network devices. Events can either convey any general information or the current status of the devices in a network. The groups of operations which are grouped under Events are listed in the table given below.

TABLE 4-5 Operations for Events

Operation	Description
Event Filters and Parsers	
Get Event Parsers	This Operation is for viewing the Event Parsers present in the server.
Set Event Parsers	This Operation is for modifying the existing Event Parser or creating a new Event Parser.
Get Event Filters	This Operation is for viewing the Event Filters present in the server.
Set Event Filters	This Operation is for modifying the existing Event Filter or creating a new Event Filter.
Event User Operations	
Save Events to File	This Operation is for saving the events displayed either in Events Panel or the selected events.
Print Event View	This Operation is for printing either the selected events or events displayed in the Events Panel.

4.6.2.3 Topology

Topology is used to add, update, delete and filter out the core Managed Objects from the database. The various operations grouped under the topology module are listed in the table given below. All are under Modify Object.

TABLE 4-6 Operations for Topology

Operation	Description
Start and Stop Discovery	This Operation is used to set the discovery status for the particular Object.
Manage and Unmanage Objects	This Operation is used to set the management status of the particular Object.
Add Network	This Operation is used to add a new network in the Topology database.
Add Node	This Operation is for adding a new node in the Topology database.
Delete Object	This Operation is for removing a particular Object from the Topology database.
Refresh Node	This Operation is for updating the status polling.

4.6.2.4 User Administration

This Operation family is mainly used in HTML UI for User Administration. The various operations available by default under User Administration are listed below.

TABLE 4-7

Operation	Description
User Configuration	This Operation is used to get the link for 'User Administration'.
Add Users	This Operation is used to create a new user.
Assign User to Group	This Operation is used to assign the user to new or existing group.
Remove User	This Operation is used to remove the user from the group.
Remove User from Group	This Operation is used to remove the particular user from the particular group only.
Get List of Users	This Operation is used to view the list of users present in the database.

4.6.2.5 Trap Parsers and filters

The various operations grouped under Trap Parsers and Filters are listed in the table given below.

TABLE 4-8 Operations for Trap Parsers and Filters

Operation	Description
Get Trap Filters	This Operation is for viewing the Trap Filters present in the server.
Set Trap Filters	This Operation is for modifying the existing Trap Filter or creating a new. Trap Filter.
Reload Trap Filters	This Operation is used to update the changes of the filter, without restarting the Server.

TABLE 4-8 Operations for Trap Parsers and Filters

Operation	Description
Get Trap Parsers	This Operation is for viewing the Trap Parsers present in the server.
Set Trap Parsers	This Operation is for modifying the existing Trap Parser or creating a new Trap Parser.

4.6.2.6 Alerts

Alerts are generated when a failure or fault is detected in the network devices. The generated Alerts get displayed in the Alert Viewer. The Alert list containing alarms of various severities like critical, major, minor, clear etc. can be viewed in the Alert Viewer. The various operations available by default under User Administration are listed below.

TABLE 4-9 Operations for User Administration

Operation	Description
Alert Filters	
Get Alert Filters	Operation is for viewing the Alert Filters present in the Server.
Set Alert Filters	This Operation is for modifying the existing Alert Filter or creating a new Alert Filter.
Set Alert Annotation	This Operation is for adding notes (annotation) to an alert.
Alert User Operations	
Get Alert Details	This Operation is for viewing the details of a particular alert.
Save Alerts to File	This Operation is for saving either the selected alerts or the alerts displayed in the current Alert Panel into a file.
Print Alert View	This Operation is for printing either the selected alerts or the alerts displayed in the current Alert Panel.
Clear Alerts	This Operation is for changing the Alert Severity as Clear.
Get Alert Annotation	This Operation is for viewing the particular existing alert annotation.
Get Alert History	This Operation is for viewing the Alert History, i.e., the change in status of an Alert from the first Alert to the latest Alert.
Alert Pickup	This Operation is used to pick up the Alert. (To attach one's ID to an alert so others know the alert is being worked.)
Delete Alerts	This operation is used to remove a particular alarm (usually because it has been solved).

4.6.2.7 Maps

A map is a graphical representation of networks and systems. Elements such as computer devices, printers, switches etc. connected in a network can be represented in a map. The operations available under Maps are listed below.

TABLE 4-10 Operations for Maps

Operation	Description
Map Editing Operations	This Operation is mainly used to configure the maps, like creation of new maps, customizing of map hierarchy, map symbol layout and map symbol renderers through the client.

4.6.2.8 Polling Unit

Polling units mentioned here refer to PolledData objects which are the basic unit of data collection. These define what data to be collected and from which network device. PolledData can be added via Client User interface. The operations possible with PolledData objects are listed below.

TABLE 4-11 Operations for Polling Units

Operation	Description
Add Polling Units	This operation permits you to add new PolledData to devices, to collect data for particular Data identifiers.
Remove Polling Units	This operation permits you to modify the definition of PolledData to change Data collection configuration.
Modify Polling Units	This operation permits you to remove the PolledData objects from database so that no more data is collected for the associated Data identifier.
Get Polling Unit	Get Polling Unit This operation permits you to retrieve PolledData details from database. If this operation is excluded in Operations Tree, you will not be able to see the PolledData information in StatsAdminPanel of Client UI.

4.6.2.9 Polling Objects

This object contains information on data collection configuration like match criteria and data to poll. Match criteria indicates from which devices data have to be collected and data to poll indicates what data to Polling objects can be created via Client User Interface, configuration file i.e. Polling.conf and API methods. The different operations possible with Polling objects are listed below.

TABLE 4-12 Operations for Polling Objects

Operation	Description
Add Polling Object	This Operation is used to create a new Polling Object and add to database for monitoring a new device or the existing device.
Delete Polling Object	This Operation is used to remove the existing Polling Objects.
Modify Polling Object	This Operation is used to modify the criteria of the existing Polling Object for making performance analysis better.
Change Polling Object Status	The Polling Object can be enabled or disabled by using the optional parameters called "status". The parameter can be changed as "True" or "False". The Operation 'Change Polling Object Status' is used to change the status of the polling Object.
Get Polling Object	This Operation is used to view the criteria of the particular Polling Object.

4.6.2.10 Poll Filters

Poll Filter is used to fine tune the Data collection configuration. When NMS Server starts Managed objects are created and they are passed through Polling.conf. If match criteria satisfies, according to the definition of Polling object, PolledData are created. Just before these PolledData objects are added to database, existing PolledData can be modified, new PolledData

can be added for the Managed object or existing PolledData can be removed using Poll Filters. Different operations possible with Poll Filters are listed in the following table.

TABLE 4-13 Operations for Poll Filters

Operation	Description
Get Poll Filters	This operation permits retrieval of Poll Filters from the database and display them. If excluded will not allow you to view the Poll Filters list.
Update Poll Filters	This operation permits to modify Poll Filter related details.
Reload Poll Filters	This operation permits reloading to memory the modified Poll filter definitions specified in Poll filters file.

4.6.2.11 Threshold Objects

Thresholds are the basic unit for generating Threshold Events. Threshold Events are those events which get generated when the collected value for a particular agent satisfies the threshold criteria. The Threshold objects are formed by reading the Threshold.conf present in <NMS Home>/conf directory, which contains information about the thresholds that has to be generated when a particular condition is satisfied. The various default operations possible with Threshold Objects are provided in the following table.

TABLE 4-14 Operations for Threshold Objects

Operation	Description
Add Threshold Object	This Operation is used to create a new Threshold Object to create Threshold Events for a new device or the existing device.
Modify Threshold Object	This Operation is used to modify the existing Threshold Object for making performance analysis better.
Delete Threshold Object	This Operation is used to remove the existing Threshold Object.
Get Threshold Object	This Operation is used to view the particular Threshold Object.

4.6.2.12 AT Object Operation

AT Object Operation contains operations specific to Allied Telesis products. These operations are provided in the following table.

TABLE 4-15 Operations for AT Object Operation

Operation	Description
Performance Operation	
Monitor Collections Operations	Permits the Monitored Collections dialog for routers
Statistics Operation	Permits the Performance/Configured Collections display
Configuration Operation	
Configure SNMP Operation	Permits Configured SNMP MDTI operation
Device Backup/Restore Operation	Permits backup and restore operations
Software Configuration Operation	Permits software configuration operations

TABLE 4-15 Operations for AT Object Operation

Operation	Description
Device Information Operation	Permits the display of device information
SNMP Agent Operation	Permits SNMP Agent operations
SNMP Community Operation	Permits SNMP Community operations
Configure VLAN Operation	Permits VLAN configuration operations (Includes EPSR)
Card Management Operation	Permits card management operations
Port View Operation	Port Management Operation (complete control) Port Provision Operation (view and provision/deprovision)
SysLog Management Operation	Permits access to syslog application
Command Script Mgmt Operation	Permits command script management operations
Configuration File Mgmt Operation	Permits file management operations
Profile and QoS Operation	Profile and QoS Policy Operations
Rediscover Operation	Permits rediscovery operations
Application Manager Operation	Permits access to the Application Manager
Telnet Cutthru Operation	Permits Telnet cut-through
GUI Cutthru Operation	Permits GUI cut-through
Manage CLI Users Operation	Permits CLI user management operations
Manage System Log Configuration	Permits access to System Log Configuration (control the system log daemon, event logging, and the logs that are stored in the database)

4.7 Remote Authorization (RADIUS / Tacacs+) on Devices

RADIUS and Tacacs+ are remote authentication protocols used by devices to authenticate telnet user-client sessions. When the user logs in, the device forwards all login information to the RADIUS servers first, followed by the Tacacs+ servers (if RADIUS is not available) for authentication until it receives a response back from one of them. Depending on the exchange of messages, the device grants or denies access for the session. RADIUS uses UDP/IP for transmitting information across the network, while Tacacs+ uses TCP/IP.

Note: For complete information on the RADIUS / Tacacs+ protocol and how they are handled by Allied Telesis devices, refer to the *iMAP Software Reference Manual* and *AlliedWare Plus Reference Manuals*.

When the AlliedView NMS is initially configured and logs in to a device that is configured with RADIUS/Tacacs+, only a user-level privilege can be assigned. To allow for security officer level, the client must send a special “ENABLE SECURITY OFFICER” command string (“ENABLE” for AlliedWare Plus devices) back to the server. The server prompts for a “Passcode” (“Password for AlliedWare Plus devices). The client then transmits the appropriate passcode (password) after which the session has a Security Officer level (level 15).

Note: Only *iMAP (15.1 and up)* and *AlliedWare Plus (5.4.2 and up)* devices support Tacacs+.

Note: Devices other than *iMAPs* supporting RADIUS provide a direct “SECURITY” access after first authentication, if discovered as the “SECURITY” level user.

4.7.1 RADIUS

For devices that use the RADIUS, authentication is done on a per device basis that is datafilled for the device’s MO properties. Refer to the following figure.

The screenshot shows the 'Allied Telesyn Object Properties' dialog box with the 'Symbol Properties' tab selected. The form is organized into three main sections:

- SNMP RELATED PROPERTIES:** Includes fields for Snmpport (161), Community (public), WriteCommunity (private public friend), SysName (empty), SysDescr (Telesyn 9400 Multiservice Access Platform v), SysOID (.1.3.6.1.4.1.207.1.15.4), and BaseMibs (RFC1213-MIB).
- CLI RELATED PROPERTIES:** Includes fields for LoginPrompt (Username:), PasswordPrompt (Passtcode:), Login (eblau), Password (***), CliPort (23), ShellPrompt (>>), RemoteAuthProtocol (RADIUS), and RemoteAuthPassword (*****). Red arrows point to the 'RADIUS' and '*****' values.
- OTHER PROPERTIES:** Includes fields for HostNetmask (255.255.255.0), UserClass (null), Tester (max), and FailureThreshold (1).

Navigation buttons at the bottom include '<<Back', 'Next>>', 'Modify', 'Close', and 'Help'.

FIGURE 4-15 Filling out the MO Property Form for Remote Authentication

4.7.2 Tacacs+ (Using the CLI Login Manager)

For Tacacs+, the user can provision on a per-device basis as well, but the administrator can also provision this on a system-wide basis, using the special User ID TACPLUS_USER, and then filling in the appropriate password.

When the user selects *Tools -> Manage CLI Users*, the Discovery Configurator with the CLI Logins tab appears.

4.8 NMS RADIUS Client Support

4.8.1 Overview

Starting in NMS Release 11.0 SP5, RADIUS Authentication for NMS user logins is supported. Prior to this feature, NMS supported devices that used RADIUS/TACACS (see 4.7), but NMS user ids were not authenticated via these methods. With this feature, an open source RADIUS client is integrated into the NMS server, using a central RADIUS server on the customer's network.

Note: RADIUS is specified in RFC 2865 (<http://www.ietf.org/rfc/rfc2865.txt>).

The NMS Security Management feature, as explained in 4.4, has pre-defined groups (Users and Admin) with default permissions. Moreover, custom groups can be added. The Security Management and NMS RADIUS Client Support feature need to be coordinated to ensure that these groups and permissions are usable to the RADIUS-authenticated users. This is explained in detail in the rest of this section, especially 4.8.4.

Activation of this feature involves provisioning in two main areas:

1. At the RADIUS server, accounts are defined in the RADIUS database according to the configuration procedures of the RADIUS platform selected (Free RADIUS, Cisco Secure ACS etc.). Accounts are given passwords and assigned to permission groups.
2. At the NMS server, RADIUS authentication is enabled or disabled from an Authorization Configurator GUI, as explained in 4.8.2.

Note: Provisioning at the RADIUS server is outside the control of this feature, but is required and must be provisioned correctly for this feature to function correctly. Moreover, there are many RADIUS server distributions, and all should be compatible, but the example inputs are for FreeRADIUS and Cisco Secure ACS.

The following figures provide an overview of the process and steps to activate RADIUS (the steps to deactivate are essentially the reverse).

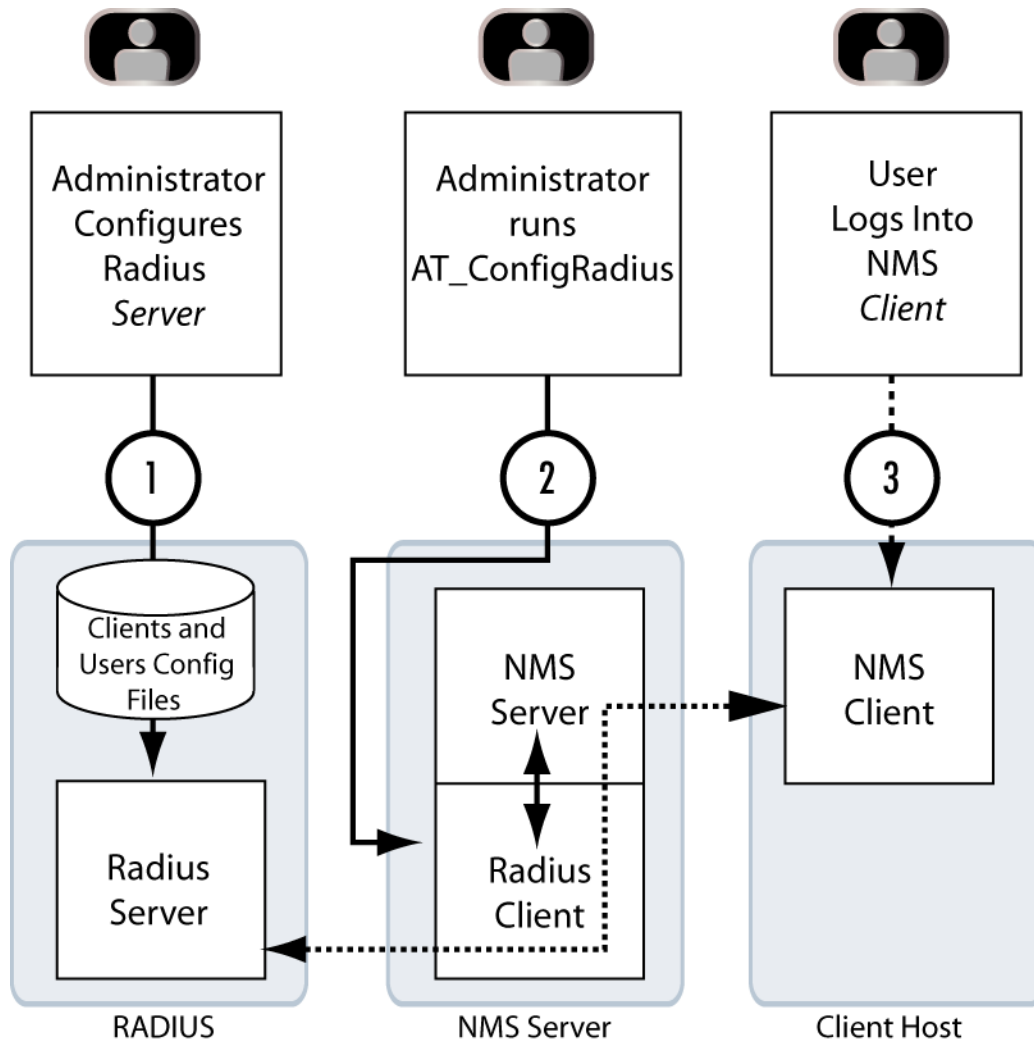

FIGURE 5 Overview - NMS Server with RADIUS Client

4.8.2 RADIUS Configurator Tool (with Valid License)

Once this feature is installed the login procedure is transparent; the client interface is the same with or without RADIUS authentication.

The main change to the NMS server is the addition of the `AT_ConfigureRadius` tool, which can be launched as follows:

1. On Windows, double-clicking `AT_ConfigureRadius.bat` in the `<NMS_HOME>\bin` directory.
2. On Solaris, running `AT_ConfigureRadius.sh` in the `<NMS_HOME>/bin` directory.
3. In a non-windowing environment, running the tool with the command `./AT_ConfigureRadius.sh`

Methods 1 and 2 bring up the RADIUS Configurator GUI; method 3 uses a command interface. Each interface is explained below.

Note: This tool is only available if the user has a license with the RADIUS feature registered. If not, the following message appears when double-clicking on the `AT_ConfigureRadius.bat` icon.

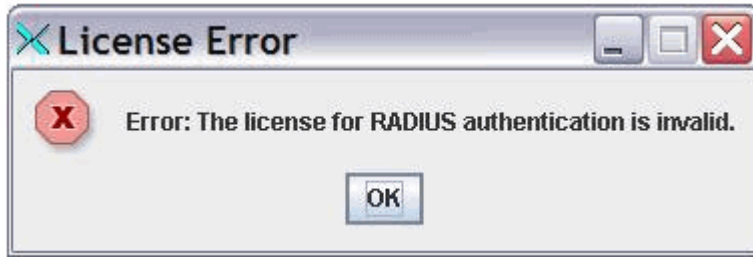

FIGURE 4-1 Error Message for Invalid License

The purpose of this tool is to configure the NMS *server* as a RADIUS *client*-that is, enable/disable RADIUS authentication and create a list of server contact information (address and port) and shared secrets to be used during authentication when enabled.

The shared secret is an encryption key stored separately on both platforms (RADIUS server and RADIUS client) and is never transmitted over the network.

4.8.2.1 GUI Interface

The first time the tool is launched, it shows the state is “Off” and shows no parameters, as shown in the following figure:

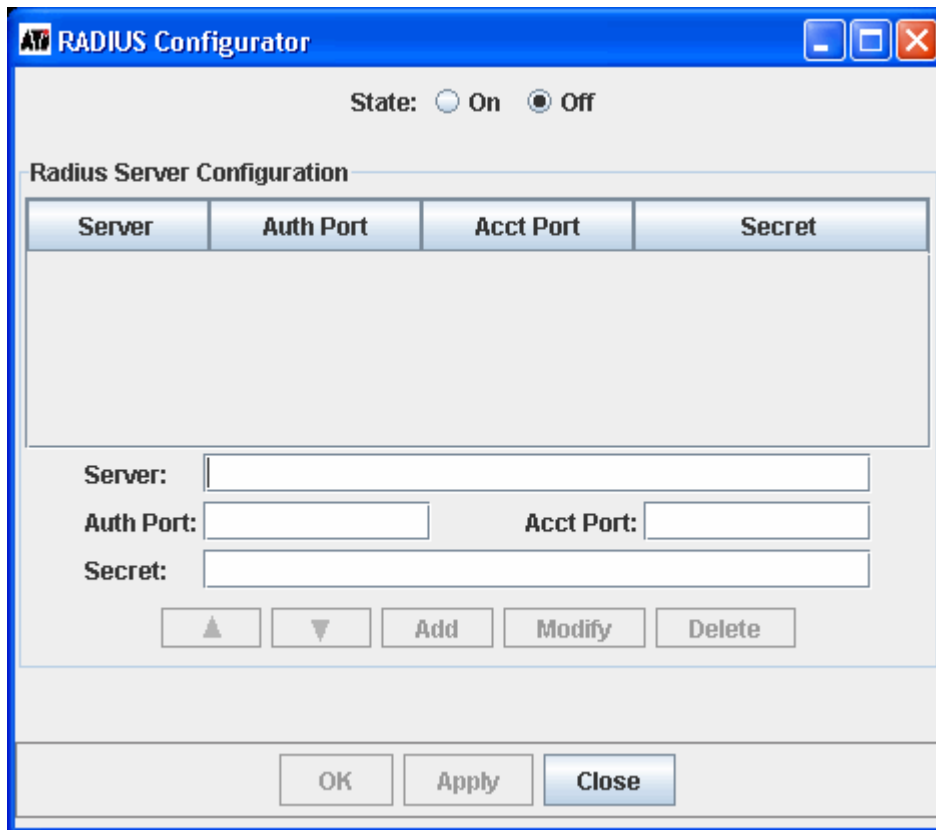
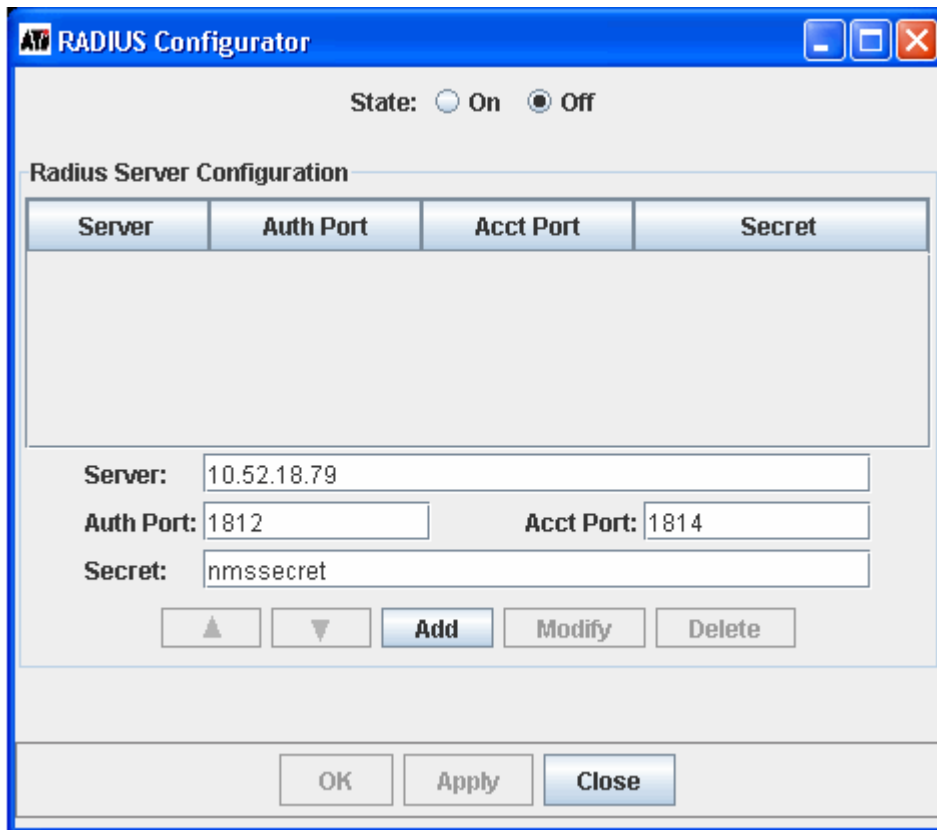

FIGURE 5 RADIUS Configurator - Initial Screen

Servers can be added via the fields on the lower part of the display. Notice the “Add” button becomes enabled when all the necessary parameters have been entered:



The screenshot shows the "RADIUS Configurator" window. At the top, there is a "State:" section with radio buttons for "On" and "Off", where "Off" is selected. Below this is the "Radius Server Configuration" section, which contains a table with four columns: "Server", "Auth Port", "Acct Port", and "Secret". The table is currently empty. Below the table, there are four input fields: "Server:" with the value "10.52.18.79", "Auth Port:" with the value "1812", "Acct Port:" with the value "1814", and "Secret:" with the value "nmssecret". Below these fields are five buttons: an up arrow, a down arrow, "Add", "Modify", and "Delete". The "Add" button is highlighted in blue, indicating it is enabled. At the bottom of the window, there are three buttons: "OK", "Apply", and "Close".

FIGURE 6 RADIUS Configurator - Initial Screen - Adding a Server

Multiple servers can be added. Servers can be designated by IP addresses or valid host names. During login, the authentication process will try each server in the order displayed, from top to bottom, until one server accepts the authentication request or all servers have rejected it. The order can be changed with the arrow buttons. Note that:

- The Add button will not allow adding a server that already exists in the table.
- The Modify button will allow any change to any field as long as it won't change the server to one that already exists in the table.

Note: This tool cannot tell when host names map to existing IP addresses or not. Therefore the Add button will allow adding duplicate servers when they have different host names.

Note: There is no limit to the number of servers allowed, but more than 2 or 3 unreachable servers will cause long delays to users trying to log in because each server is tried one at a time and must timeout before the next server is tried. Therefore, servers with a history of unavailability should not be used for RADIUS authentication.

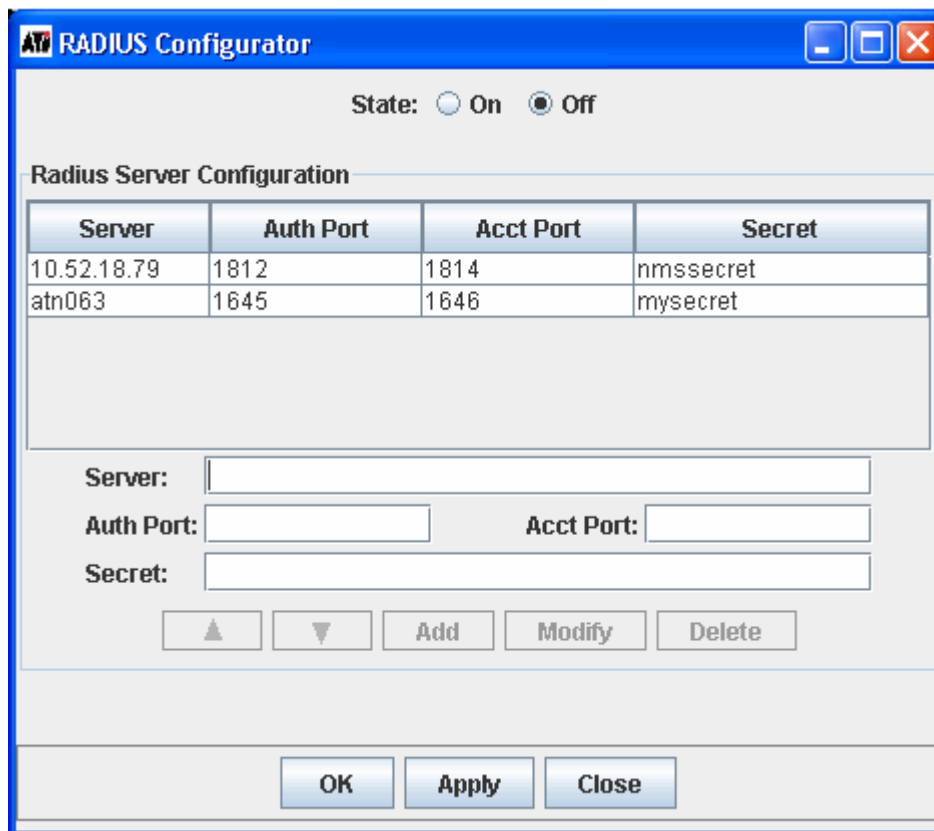

The screenshot shows the 'RADIUS Configurator' window. At the top, there is a 'State' section with radio buttons for 'On' and 'Off', where 'Off' is selected. Below this is the 'Radius Server Configuration' section, which contains a table with the following data:

Server	Auth Port	Acct Port	Secret
10.52.18.79	1812	1814	nmssecret
atn063	1645	1646	mysecret

Below the table are input fields for 'Server:', 'Auth Port:', 'Acct Port:', and 'Secret:'. At the bottom of the configuration area are buttons for 'Add', 'Modify', and 'Delete', along with up and down arrow buttons. At the very bottom of the window are 'OK', 'Apply', and 'Close' buttons.

FIGURE 7 RADIUS Configurator - Servers Added

Whereas only one server may be added at a time and only one may be modified at a time, multiple servers may be deleted by selecting multiple rows and clicking on the Delete button.

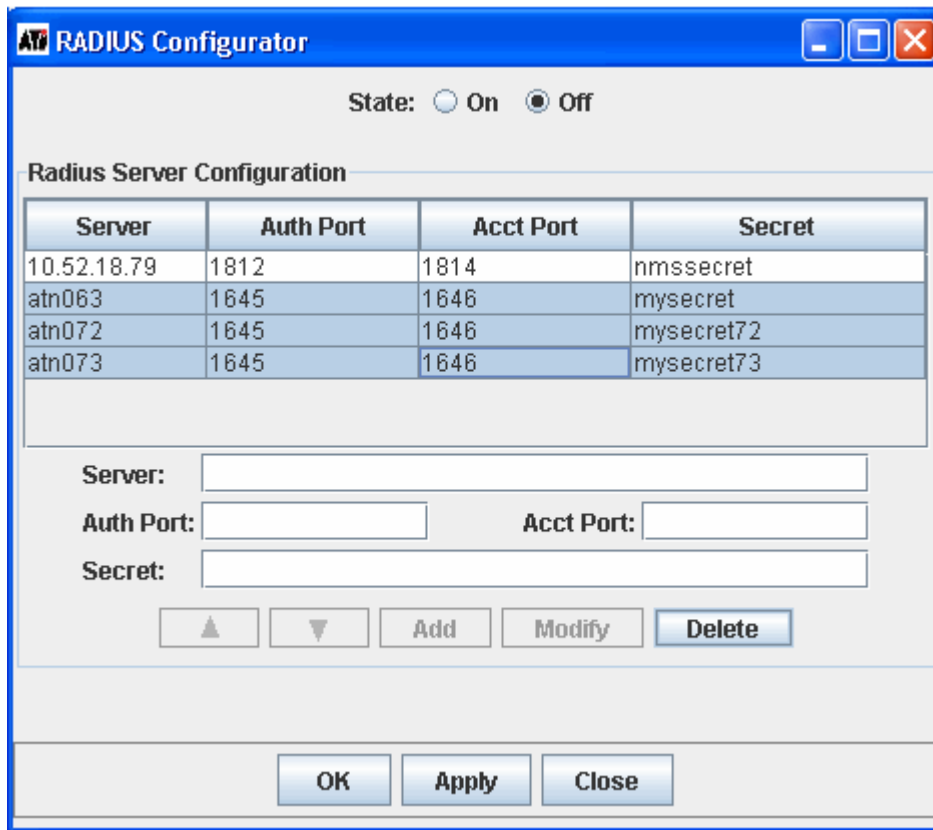

FIGURE 8 RADIUS Configurator - Deleting Servers

Changes are not saved until either the **OK** or **Apply** button is selected.

Note: When activating the NMS client, set the Status to 'On' before selecting **OK** or **Apply**.

All changes won't take effect until the server is restarted. So after changing the State to 'On' and selecting OK or Apply, the modifications are completed and the tool displays the following message:

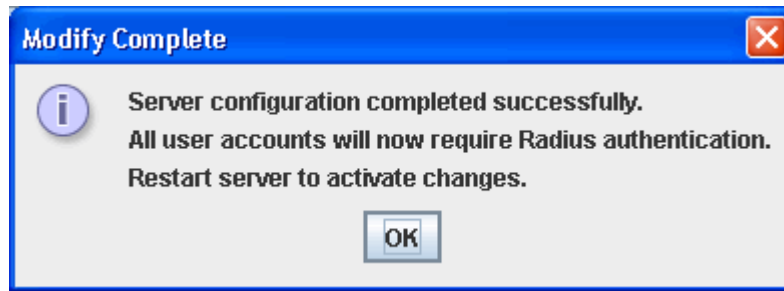

FIGURE 9 Message - RADIUS Configured, need to Restart

Note: When RADIUS is activated or deactivated, the NMS server is shut down. It must then be restarted.

Once RADIUS authentication is enabled, the only users that can log in are the ones previously defined in the RADIUS server(s).

4.8.2.2 Command Line Mode

The AT_ConfigureRadius tool can also be used in a command line mode, which is useful in a non-windowing environment, such as Solaris without X-Windows. Command line mode is invoked by running the tool from the command with one or more arguments, as demonstrated by the help command:

```
./AT_ConfigureRadius.sh help
    help
    print
    add [pos] server authport acctport secret
    remove server
    enable
    disable
```

- Print displays the current configuration.
- Add adds a new server with the specified authport, accounting port, and secret. The optional pos argument allows specifying a position in the list of servers.
- Remove removes the specified server.
- Enable enables RADIUS authentication and disable disables it.

The following is an example session:

```
$ ./AT_ConfigureRadius.sh add 10.52.18.78 1645 1646 nmssecret

RADIUS Authentication State=DISABLED

Server          Auth Port    Acct Port    Secret
-----
10.52.18.79     1812         1814         nmssecret
10.52.18.78     1645         1646         nmssecret

$ ./AT_ConfigureRadius.sh add 2 10.52.18.77 1812 1814 nmssecret
```

```
RADIUS Authentication State=DISABLED
```

Server	Auth Port	Acct Port	Secret
-----	-----	-----	-----
10.52.18.79	1812	1814	nmssecret
10.52.18.77	1812	1814	nmssecret
10.52.18.78	1645	1646	nmssecret

```
$ ./AT_ConfigureRadius.sh enable
```

```
RADIUS Authentication State=ENABLED
```

Server	Auth Port	Acct Port	Secret
-----	-----	-----	-----
10.52.18.79	1812	1814	nmssecret
10.52.18.77	1812	1814	nmssecret
10.52.18.78	1645	1646	nmssecret

```
// Restart NMS server to activate changes.
```

```
$ ./AT_ConfigureRadius.sh remove 10.52.18.77
```

```
RADIUS Authentication State=ENABLED
```

Server	Auth Port	Acct Port	Secret
-----	-----	-----	-----
10.52.18.79	1812	1814	nmssecret
10.52.18.78	1645	1646	nmssecret

4.8.3 Example Configurations

4.8.3.1 Overview

The following examples go through setting up of the NMS RADIUS Client Support and include inputs at both the RADIUS and NMS servers.

Regardless of the platform used (FreeRadius or Cisco Secure ACS), there are four main steps. The first three are for configuring the RADIUS server:

1. Identify the Vendor Specific Attribute (VSA) that names the permission groups
2. Identify the NMS servers that will serve as RADIUS clients
3. Define user ids and assign them to permission groups, information that is included with the VSA

The fourth step is:

4. Configure the NMS server to use the RADIUS server(s).

The following table shows example accounts that are used in this example.

TABLE 4-16 Account Name Examples

User Name	Password	Groups	Notes
Keith_K	knk1knkZ	Admin	Already created on the NMS
John_L	jhl6jhlX	Users	Not already created on the NMS
Paul_M	plh7plhY	Admin	Already created on the NMS

Note: Admin and Users are the default groups on the NMS available for assignment, though custom groups may be added using the Security Manager on the NMS client. When adding custom groups to a network of NMS servers, the same custom groups must be added to each server individually to be usable by the same set of RADIUS-authenticated users. Refer to [4.8.4](#).

Note: Users can optionally be assigned to multiple groups. If so, in some RADIUS servers group names must be separated by commas, contain no white space, and the list must be enclosed by quotation marks. Refer to the server documentation. (The FreeRadius example shows this.)

4.8.3.2 FreeRadius Example

FreeRadius is a free RADIUS server and is installed on 10.52.18.79.

Note: Downloads and documentation are available at <http://freeradius.org/>.

To configure for the NMS, begin with `cd to /usr/local/etc/raddb` and perform the following steps:

Note: For the account Keith_K, the password being defined on RADIUS is different than the password assigned when it had been created on the NMS. Moreover, the group association is being changed from what it had been on the NMS. This will take effect when the user logs in for the first time.

Note: The account John_L had not been created on the NMS, but is defined on the RADIUS server. It will be created on the NMS when the user logs in for the first time.

1. Add the Vendor Specific Attribute (VSA) to the dictionary:

```
VENDOR      Allied-Telesis 207
BEGIN-VENDOR Allied-Telesis
ATTRIBUTE   ATI-avnms-group 1 string
END-VENDOR  Allied-Telesis
```

2. Add the RADIUS client (the NMS) to clients.conf

```
client 10.52.18.104 {
    secret          = nmssecret
    shortname       = avnmsuser
    nastype         = other
}
```

3. Add the users to the users file:

```
Keith_K  Auth-Type := Local, User-Password == "knk_radius"
         ATI-avnms-group = "Admin,Users"

John_L   Auth-Type := Local, User-Password == "jhl6jhlX"
         ATI-avnms-group = Users
```

4. Configure the NMS to use this RADIUS server, either by itself or within a list of RADIUS servers. Using the `AT_ConfigureRadius` tool, assuming the server location is 10.52.18.79, the auth and acct ports are 1812 and 1814 respectively (FreeRADIUS defaults), add the selected line to the NMS configuration, as shown in the following figure.

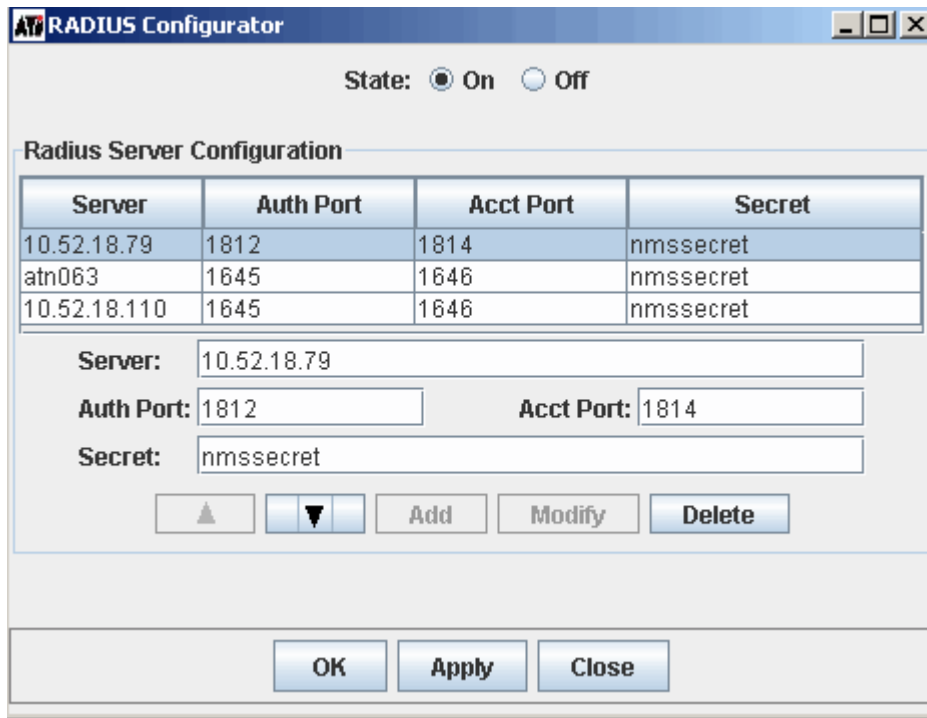

FIGURE 4-1 Configuring NMS as RADIUS Client

4.8.3.3 Cisco Secure ACS Example

Cisco Secure ACS is a widely-used fee-based RADIUS and TACAC server available from <http://www.cisco.com>. It comes in platform-specific versions, including various Windows versions.

Note: The NMS is the RADIUS client, which is known as the NAS in the RFC, and is called the AAA Client in Cisco terminology.

Note: Whereas FreeRADIUS defines VSAs in their dictionary files, Cisco defines VSAs in a RADIUS Vendor/VSA import file.

Note: Whereas FreeRADIUS defines users and clients in simple configuration files, Cisco uses an extensive web-enabled graphical user interface.

To configure Cisco Secure ACS for the NMS, perform the following:

- To configure the VSA file, perform the following:
 - Create a RADIUS Vendor/VSA import file, for example, `c:\ACS_Data\allied-telesis.ini`, containing the VSA definition:

```
[User Defined Vendor]
Name=Allied-Telesis
IETF Code=207
VSA 1=ATI-avnms-group

[ATI-avnms-group]
Type=STRING
Profile=OUT
```

2. Use CSUtil.exe -listUDV to list available slot numbers and identify one that is unassigned. If none are unassigned, this RADIUS instance has reached its maximum and cannot be used. Either free one or get another server.
2. Add the NMS server as the RADIUS client.
 1. Use CSUtil.exe -addUDV <slot> c:\ACS_Data\allied-telesis.ini to import the VSA file.
 2. Use the Web interface to configure the AAA client (the NMS) and Users with the VSA:
 3. Use “Interface Configuration” to enable RADIUS (Allied-Telesis) for Users.
 4. Use “Network Configuration” to set authentication for the AAA client using RADIUS (Allied-Telesis)
3. Add users and permission groups.
 1. Use “User Configuration” to create the users, assign their passwords, and, at the bottom, enable and assign the VSA (ATI-avnms-group) to the user's permission group(s). Separate multiple group names with commas but do **not** enclose the string with quotation marks.
 2. Select any other relevant options and data fill as necessary.
 3. Be sure all changes are submitted and applied where necessary.
4. Configure the NMS to use this RADIUS server, either by itself or within a list of RADIUS servers. Using the AT_ConfigureRadius tool, assuming the server location is 10.52.18.110, the auth and acct ports are 1645 and 1646 respectively (Cisco defaults), add the selected line to the NMS configuration, as shown in the following figure.

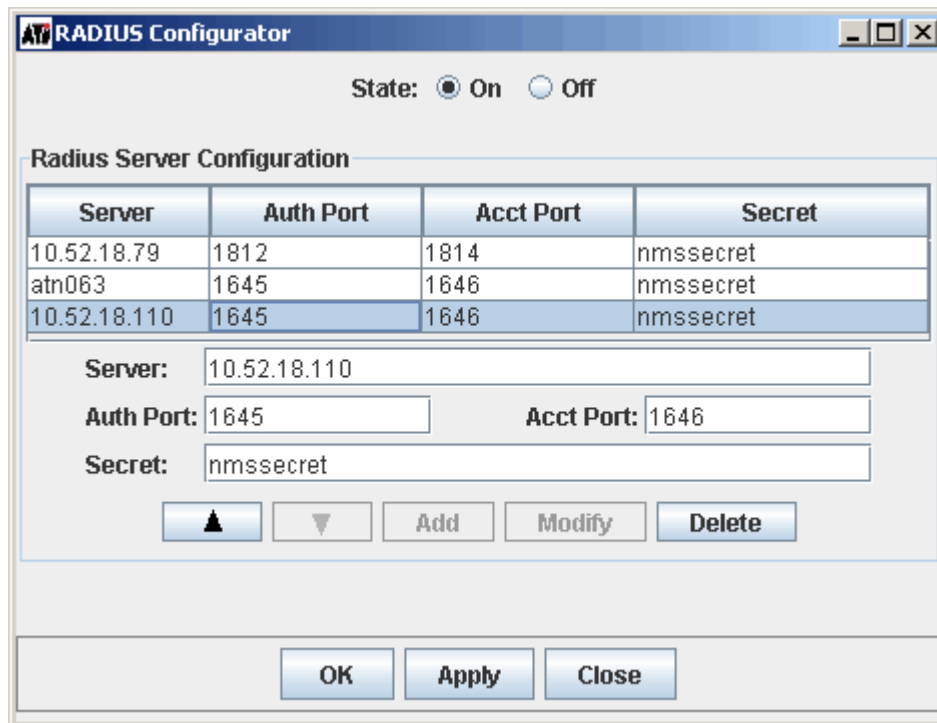

FIGURE 4-2 Configuring NMS as Cisco Secure ACS Client

4.8.4 Feature Interactions (RADIUS Server De-activated or Unavailable)

As shown throughout this section, including in the examples, Admin and Users are the default groups defined on the NMS server, and custom groups may be added using the NMS Security Management feature. The administrator can then choose to include these groups when defining accounts on the RADIUS server.

In most cases, once the administrator has defined these accounts, the RADIUS server is activated, and users log in to the NMS transparently using these defined accounts. The administrator could

1. Change passwords for existing user IDs

2. Change which users belonged to which permission groups.
3. Assign new user IDs and passwords, and associate them with a group or groups

Note: To make these changes, the RADIUS server may need to be restarted. Refer to the appropriate documentation.

However, once the RADIUS NMS client feature has been set up, the following scenarios could occur:

- The customer could de-activate the RADIUS NMS client through the RADIUS Configurator tool.
- The RADIUS server(s), while configured and activated, might not be available.

Refer to [4.8.4.1](#).

4.8.4.1 Login behavior RADIUS Server De-activated or not Available

When this occurs, the user now must log in with a locally authenticated account, which follows these rules:

- Accounts will belong to the permission groups they had when last used, regardless of whether they were authenticated using RADIUS.
- The passwords are set to what they were the last time **before** RADIUS authentication. This means:
 - If the account was created on the NMS prior to RADIUS authentication, the password reverts to what it was set at on the NMS server.
 - If the account was created on the RADIUS server, the id is still valid, but the default password is the same as the user ID

Using the example accounts listed in [4.8.3](#) this would mean:

- The user ID Keith_K would revert to the password knk1knkZ, since that is what the pw was set to before RADIUS authentication. However, it would belong to the groups Admin and User, since those were the associated groups defined and last used.
- The user ID John_L would have the password John_L, since the account was created on the RADIUS server.
- The user ID Paul_M would still have a pw of plh7plhY and belong to the Admin group, since it was never created on the RADIUS server

5. Controlling and Provisioning Network Devices

5.1 Overview

In providing network management functions, the AlliedView NMS can provision a single device. However, in many cases a set of devices should be provisioned together, and the AlliedView NMS provides a GUI that allows the administrator to create a set of devices and then use wizards that allow provisioning across that set of devices. [Figure 5-1](#) highlights the various options that appear when choosing a device.

Note: When more than one device is selected (by dragging or using the Shift key), only those operations that can be performed on more than one device are active. This is further controlled by whether the devices are from the same or different families.

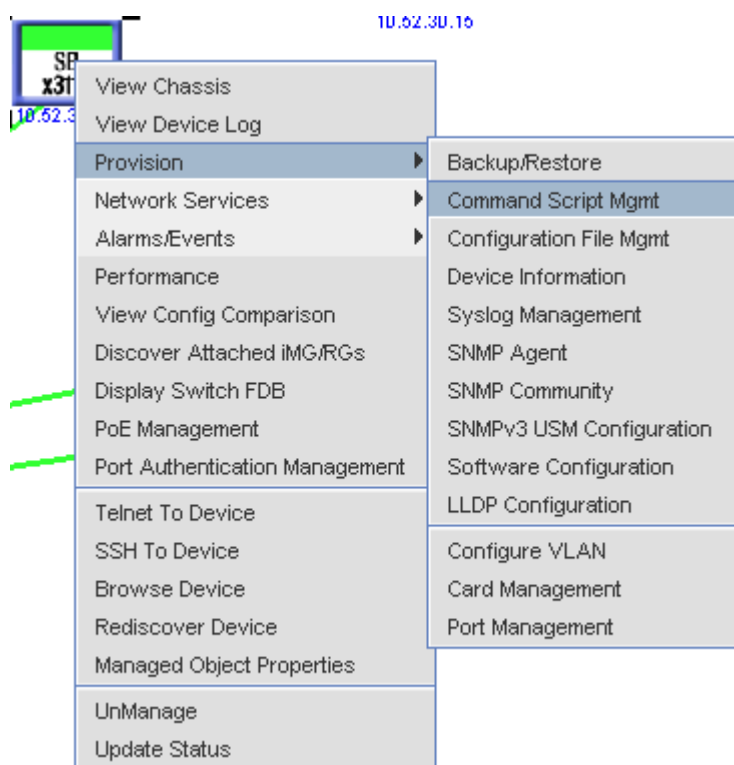

FIGURE 5-1 Provisioning Menu - Options for a Single Device

The following subsections go through all of the menu options available for the AT Network Elements. Separate subsections highlight the provisioning tasks.

Use the following table to locate the task you wish to perform. If you are using AlliedView NMS, use the screen or form name you are seeing to locate the relevant section.

Note: The AlliedView NMS supports all cards that can be configured with the various CFC cards, and this is reflected in the chassis view as well as the various types of management. Refer to the Feature Guide for the available CFC cards and the products they support.

TABLE 5-1 Task List for Provisioning

Task	Screen / Form Name (if Applicable)	Section
View Chassis		(5.2)
Provision Allied Telesis Device	Overview of Provisioning Application	(5.3.1)
- Backup/Restore	Device Backup/Restore in pull-down	(5.3.2)
- Command Script Management	Command Script Mgmt in pull-down	(5.3.3)
- Configuration File Management	Configuration File Mgmt in pull-down	(5.3.4)
- Device Information	Device Information in pull-down	(5.3.5)
- Device Log Management	SysLog Management in pull-down	(5.3.12)
- SNMP Agent	SNMP Agent in pull-down	(5.3.6)
- SNMP Community	SNMP Community in pull-down	(5.3.7)
- Software Configuration (non-custom)	Software Configuration in pull-down	(5.3.9)
- Software Configuration (custom)	Software Configuration in pull-down	(5.3.10)
- LLDP Configuration	LLDP Configuration in pull-down	(5.3.13)
- MPEG Testing	MPEG Test in pull-down for CPE	(5.3.14)
Using the File Editor Window		(5.3.15)
Using the File Delete Window		(5.3.16)
SNMPv3 USM Configuration		(5.3.17)
Download Card Software	Download Software	(5.5.23)
Provisioning Data, Profiles		(5.5.24)
Provision Residential Gateway (RG)	In the provisioning screens, there an additional set of buttons, CPE and NETWORK. The user toggles between the two to select the device type.	(7.8)
- Configure VLAN		(5.4)

TABLE 5-1 Task List for Provisioning (Continued)

Task	Screen / Form Name (if Applicable)	Section
Card Management	Card Management	(5.5.1) Create (5.5.3) GE3, GE8 (5.5.4, 5.5.5) ADSL16 (5.5.6) ADSL24, ADSL24AE (5.5.7) SHDSL24 (5.5.8) CFC (5.5.9, 5.5.10) FE10 (5.5.11) FX10 and FX20 (5.5.12) POTS (5.5.13) - Card can support MGCP or SIP CES8 (5.5.14) NTE8 (5.5.15) ADSL24A/B (5.5.16) PAC24A, PAC24C (5.5.17) EPON2 (5.5.18) VDSL24 (5.5.19)) ADSL48A (5.5.20) GE24POE (5.5.25) XE1, XE1S, XE4, XE6SFP (5.5.26) GE24 cards (5.5.27)

TABLE 5-1 Task List for Provisioning (Continued)

Task	Screen / Form Name (if Applicable)	Section
- Port Management (iMAP Devices)	Port Management (iMAP Devices)	Application (5.6.2) New Triple Play (5.6.3) New Ethernet (5.6.4) New ADSL (5.6.4) New CES8 (5.6.6) New NTE8 (5.6.7) New SHDSL (5.6.8) New EPON (5.6.9) New ONU (5.6.10) New VDSL24A/B (5.6.11) View Triple Play (5.6.12) View Status (5.6.13) Add Voice Line (5.6.14) View iMG/RG (5.6.15) View Ethernet (5.6.16) View ADSL (5.6.17) View SHDSL (Bonding) (5.6.18) View POTS24 (5.6.19) View CES8 (5.6.20) View NTE8 (5.6.21) View SHDSL (5.6.22) View EPON (5.6.23) View ONU (EPON to iMG / ON1000) (5.6.24) View VDSL24 (5.6.25) View Statistics (5.6.26) View Port Logs (5.6.27) View DHCP status (5.6.28) View FDB status (5.6.29) View Video status (5.6.30) ATM Bonding (5.6.31) STP Tab (5.6.32)
- Port Management (non-iMAP Devices and Features)	Rapier/Switchblade Devices GenBand Reports POE	5.7.1 5.7.2 5.7.7
Dual End Line Testing (DELT) Single-End Line Testing (SELT) Diagnostics for ATMBOND Support of CWMP with TR-069 Device		5.7.3 5.7.4 5.7.5 5.7.6
View Task List table	View Tasks	(5.8)

TABLE 5-1 Task List for Provisioning (Continued)

Task	Screen / Form Name (if Applicable)	Section
Network Services	HVLANS Network VLANs Profile Management QoS Management Customer Management Enhanced Protection Switched Ring (EPSR) UPC Monitoring	Section 6.
Query/Control Device - Alarms/Events - Performance - Compare Configuration Files - Discover Attached iMG/RGs - Display Switch FDB - Telnet / SSH to Device - Browse Device - Rediscover Device - Managed Object Properties - Manage/UnManage - Update Status - SSH	Alarm Panel and Network Events panel Configured Collection Panel iMap Device, Applications Discover Attached iMG/RGs in pull-down Switch Forwarding Database window telnet session window / SSH Login	(5.9.1) (5.9.2) (5.9.3) (5.9.4) (5.9.5) (5.9.6) (5.9.7) (5.9.8) (5.9.9) (5.9.10) (5.9.11) (5.9.11)
Manage CLI Users		(5.10)
Customer Cutover	Port Management	(5.11)

5.2 View Chassis

To view the connection layout of a device, right click on the device and select *View Chassis*. A pop-up image of the product appears, as shown in [Figure 5-2](#).

For Rapier products, the chassis image shows in real-time the status of the links and ports. The link LEDs indicate the link state for each port. A legend on the chassis face interprets the meaning for the LED colors, such as green for an enabled 100 MHz link and amber for an enabled 10 MHz link.

The port status is indicated on the chassis face by the port color. During normal operation, the port color is gray. If an alarm occurs on a port, the color of the affected port will change to indicate the alarm condition. When the alarm is cleared, the port color will change back to gray. If multiple alarms exist, the highest priority alarm condition will be displayed. When the highest-priority alarm condition is cleared, the next lower priority alarm will be displayed.

The File pull-down has the **Refresh** and **Exit** options, while the **Applications** pull-down has the **VLAN Interface Configuration** option. This will invoke the VLAN view of the device and allow for VLAN provisioning, as described in [5.4](#).

Note: The *Refresh* option is useful in picking up any card configuration changes.

The **Polling** pull-down is a toggle function to Start or Stop Port Pollers; the pollers allows port information to be polled for the device so the port status can be updated. Along the bottom of the Chassis View is the date when the switch ports were last polled.

Below the device is general information about the device.

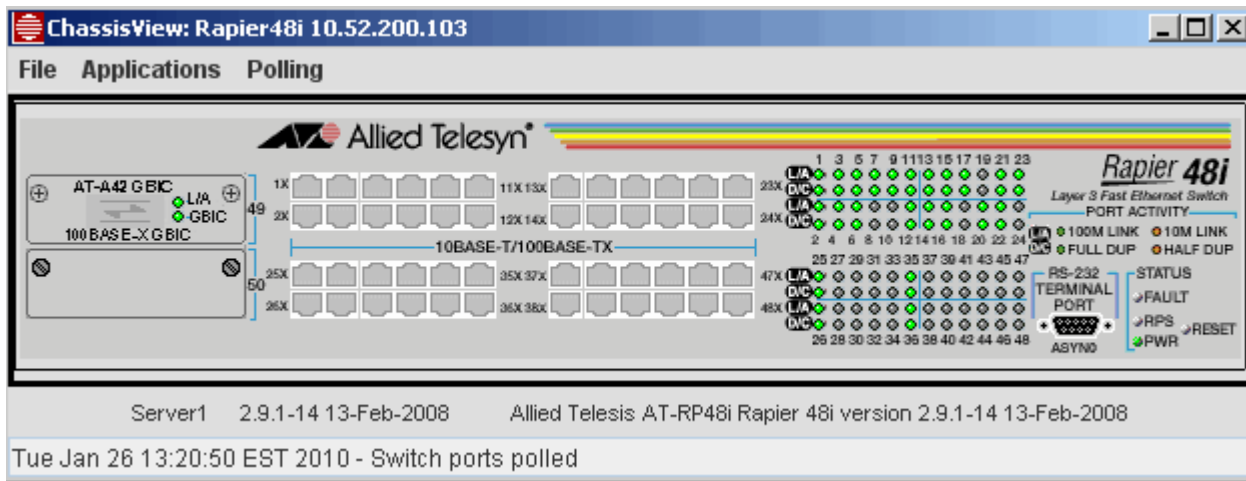

FIGURE 5-2 Chassis view of a Rapier Product

For iMAP products, the chassis view reflects which cards are configured and in what slot they are located. A graphical representation of each provisioned card is displayed, including the colors of any LEDs and any markings on the card face. An example is shown in the following figure.

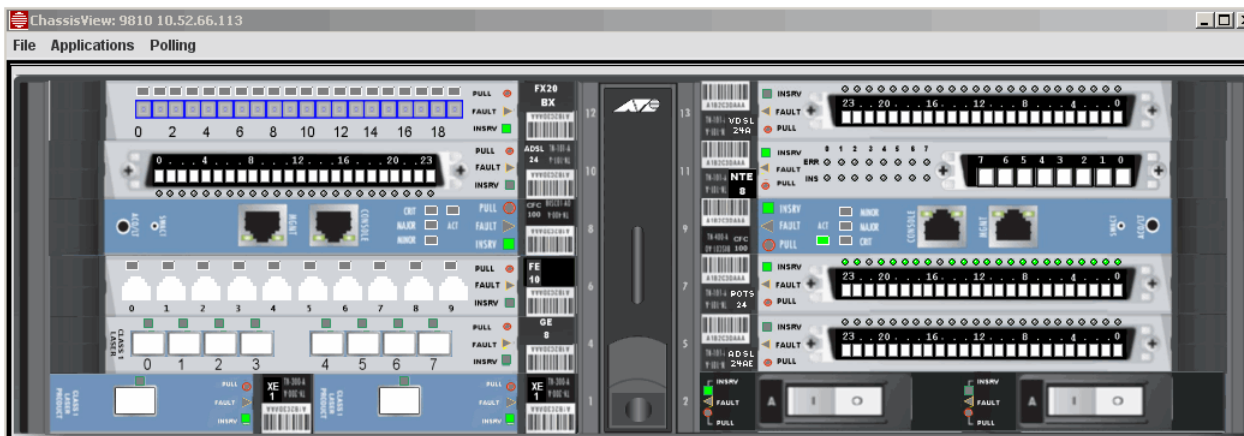

FIGURE 5-3 Chassis view of a iMAP Product (9810)

Note: For iMAP devices, alarm LEDs for the chassis view are known by polling the device for alarms, not by querying the AlliedView NMS database that has the results of the AlliedView NMS Management system (described in Section 8). Therefore, alarm LEDs produced as a result of the Fault Management system (such as thresholds or traps) are not known by the chassis view and are not displayed.

Note: For the EPON2 card, the port LED is lit when there is a discovered link on the EPON interface. (The link does not have to be authenticated.). Also for the EPON2 card, the user can click on the ONU button and a pop-up will show the status of the ONU ports. To close the pop-up, click on the square labeled Port <no.> ONUs, as highlighted in Figure 5-3.

5.2.1 Display Types

There are four types of displays for cards in the chassis view:

- Card is provisioned and installed - The card is displayed.
- Card is pre-provisioned but not installed - The card appears as a provisioned/installed card, but the LEDs indicate the *provisioned* card state, and the Fault LED is lit with the “card not present” fault.

- Card is installed but not provisioned - The card appears grayed-out and has the label “NOT PROVISIONED” across the front as shown in the following figure.



FIGURE 5-4 An Example NOT PROVISIONED Card in the Chassis View

- Unknown card - When the chassis view detects a card that is not supported, it displays the board with an “Unknown Board” image. Refer to the following figure.

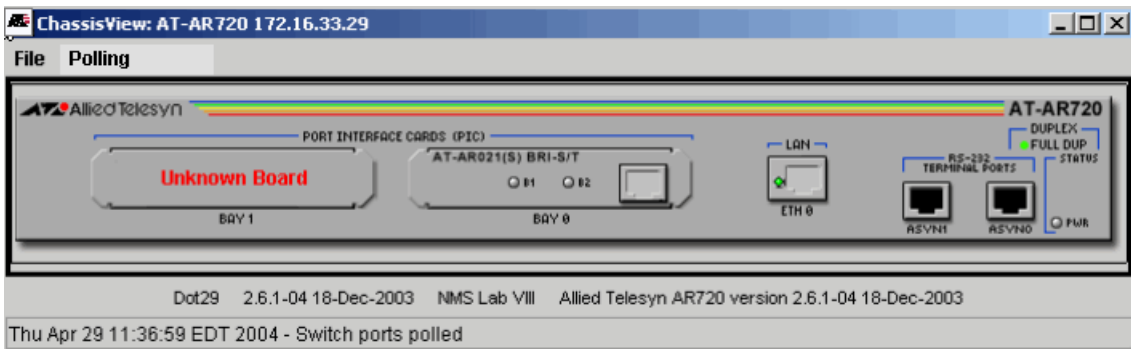

FIGURE 5-5 An UNKNOWN Card in the Chassis View - AT-AR720 Device

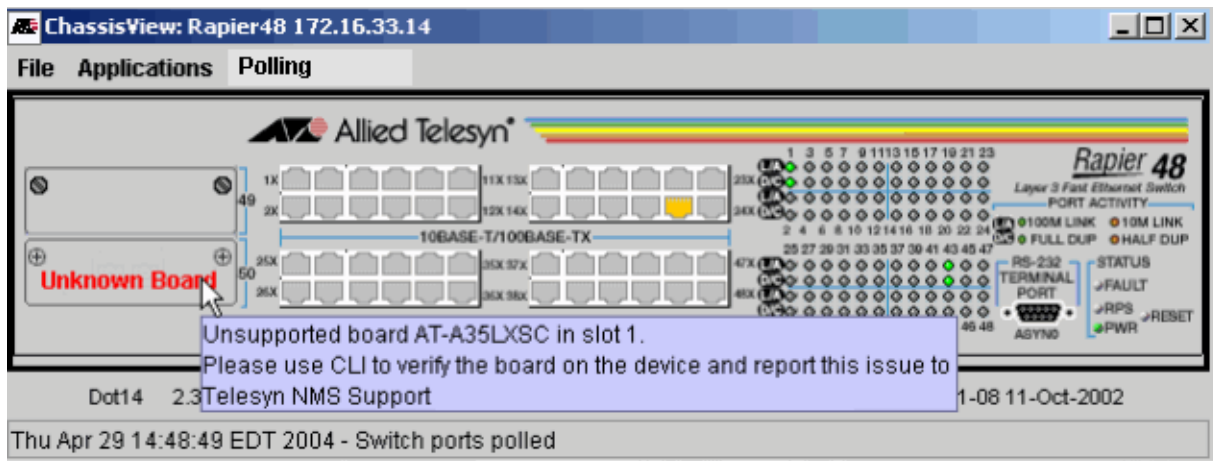

FIGURE 5-6 Tooltip for an Unknown Board Image

Like the Rapier product chassis view, this view also has the **Refresh** and **Exit** options, while the **Applications** pull-down has the **VLAN Interface Configuration** option.

The **Polling** pull-down is a toggle function to Start or Stop Poll Pollers; the pollers allows port information to be polled for the device so the port status can be updated. Along the bottom of the Chassis View is the date/time when the switch ports, card states, and alarms were last polled. As each is updated, each will replace the previous poll result.

Note: Polling is suspended while Vlan data is retrieved or updated.

Note: For the AT-x610, stacking will not start until after the unit has been booted and the stack-XG card has already been inserted. If the card is removed (or is replaced), and the x610 is not rebooted, the chassis view shows a duplicate image.

5.2.2 Display of VLAN-based HVLANS (Tunneling)

For the iMAP and SBx3112, an outer tag can be applied for certain ethernet-based cards, allowing an outer VLAN to be applied to several customer interfaces. The AlliedView NMS cannot be used to create these, but the chassis view does show where these tunneling-type HVLANS are located. Refer to the following figure.

Note: Refer to the Allied Telesis Feature Guide for more information on VLAN-based HVLANS.

The screenshot shows the ChassisView interface for a Telesyn 9400 Multiservice Access Platform. The top section displays a rack of units with various status indicators (INSRV, FAULT, PULL) and labels (NTE, ADSL, SHDSL, CFC). Below the rack view, there are configuration fields for Vlan Interfaces (3000 test), Tagged Ports (ETH:[0.0-1]), IP Address and SubNet, and Untagged Ports (None). The Telesyn Specific Parameters section includes Device Wide Parameters (Access Interface: MGMT, ICMP: Enabled) and Vlan Interface Parameters (Double Tagged (Hv)lan: TRUE, Forwarding Mode: Standard, Translation Ports: None, Hv)lan Type: VLAN Tunneling, Tunneling Vlan: 512). At the bottom, there are buttons for Create, Delete, Reset, View Last Action, Less, Apply, and Chassis View. The footer shows the version 7.0.0 and the device name Telesyn 9400 Multiservice Access Platform.

FIGURE 5-7 Tunneling VLANs Displayed on Chassis View

5.2.3 Notes on Chassis View

Following are device-specific notes on the chassis view:

- 9000 devices
 - Displaying port status/alarms in the Chassis View is supported.
 - Filler plates are included in the chassis view.
 - Support the FAN8 module in the 9700. This module is always displayed (even if removed for maintenance). The states of the Pull, Fault and Insrv LED components on the Fan module in Chassis View reflect those of the LEDs on the physical device.
 - The “Pull” LED appears gray for a pre-provisioned (i.e. not present) board.
 - When the mouse is over a card, a tool tip indicates the Status (Online, Not Installed etc) of that card.
 - The “Unknown Board” image for the iMAP devices now represents either a board which is not supported by the NMS, or a board which is not recognized by the device.
 - A pre-provisioned card in the Chassis View is distinguishable from a physically present card by the following visual cues.
 - The yellow “fault” LED is lit and the associated fault is “Card Not Present” viewable by moving the mouse over the LED image.
 - The “Pull” and “Insrv” LEDs are gray. In a physical card, one or the other of these will be on at all times.
 - The status of the card is “Not Installed”, viewable by moving the mouse over the card background.
- AT-8324
 - The Chassis View for the AT-8324 shows the chassis as a module; if multiple AT-8324s are stacked then they will all be displayed in one dialog, as a stack.
 - The following uplink boards are supported in Chassis View: AT-A15/LX, AT-A15/SX, AT-A16, AT-A17, AT-A17/SM15, AT-A18, AT-A19.
 - Fault LED on the main chassis is not monitored.
 - The “master” LED on the main chassis is not monitored.
 - Displaying port alarms in the Chassis View is currently not supported.
- AT-AR7xx
 - The 4 ports on the AR026 board are pure switch ports. They multiplex into one internal ETH port. The Link LED displayed on the AR026 in Chassis View, shows the operational state of the internal port. Since these switch ports do not map to individual interfaces, they cannot be managed by the NMS.

5.3 Provisioning a Device

5.3.1 Overview of the Provisioning Interface

When selecting a device or set of devices for an application, the user must choose the application as well as the specific devices that are to share that application. Following is an example walkthrough of how to select the set of devices.

When selecting the provisioning option, the user must select one of the applications. The following figure shows what appears after right clicking on the device and selecting **Provision - > Backup/Restore**

Note: The user can select more than one device in the Physical View, right click and select the Application, and data will automatically be retrieved for those devices and displayed.

Note: When using the provisioning feature, the AlliedView NMS is aware of how many devices have been selected for each application. When the user goes from one application to another, the original

application remains with its set of devices and state: if the user then decides to return to the first application, it retains that status and set of devices.

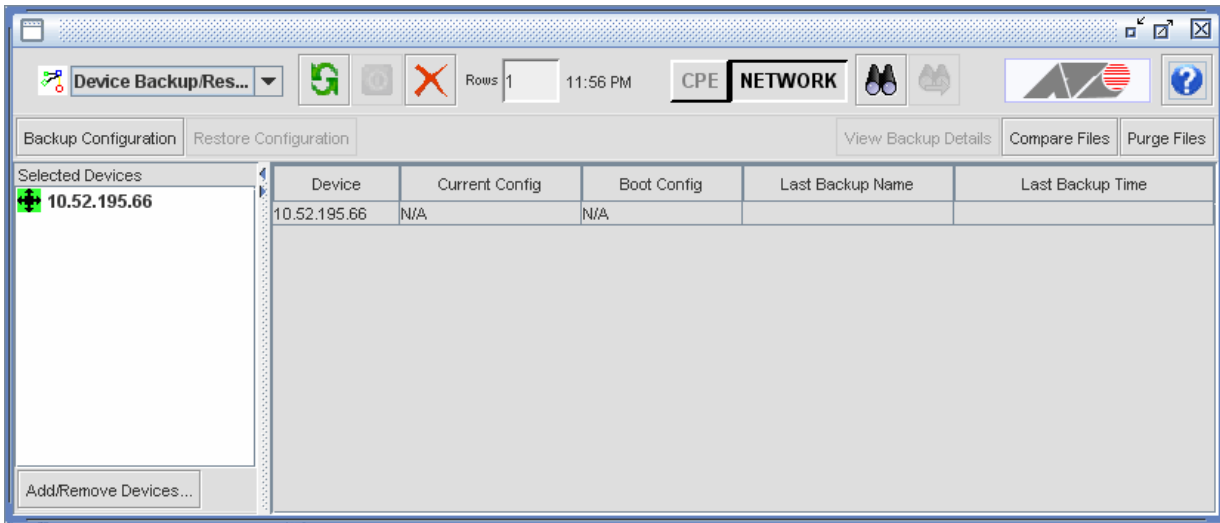

FIGURE 5-8 Selecting a Device for Backup/Restore

The selected device is included in the Selected Devices column. The following table describes the buttons that are available once an application is selected.

TABLE 5-2 Buttons Common to Applications









Button Icon	Meaning	Description
	Collect Data	Gathers data from all the devices for the application
	Abort	While data is being collected, this stop sign icon is red. Clicking on the icon at that point will stop the data collection.
	Delete all	Deletes all collected data in the generated table
	Rows	Number of rows currently in the table
Time in 24-hour format (next to Rows)	Collection Time	Once an application is run, the date and/or the time it was run
	CPE versus Network Device	Toggles between the Allied Telesis Network Devices (iMAP, Rapier, AT) and iMG/RG devices.

TABLE 5-2 Buttons Common to Applications (Continued)

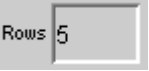
Button Icon	Meaning	Description
	Search	<p>Brings up search dialog allowing search by column for a text string, with options for starting row and matching cases shown here:</p>  <p>Table cells with the text are highlighted yellow.</p>
	Search Next	Once a text string is found, find the next table cell that has the text string.
	Allied Telesis Logo	This button is enabled when a task is started but not complete, and animated while the data collection or the application task is active. Note that scheduled tasks run independently and so do not activate this button. However, any values that are being updated in the displayed application table will be updated.
	Help	Invokes context-sensitive help

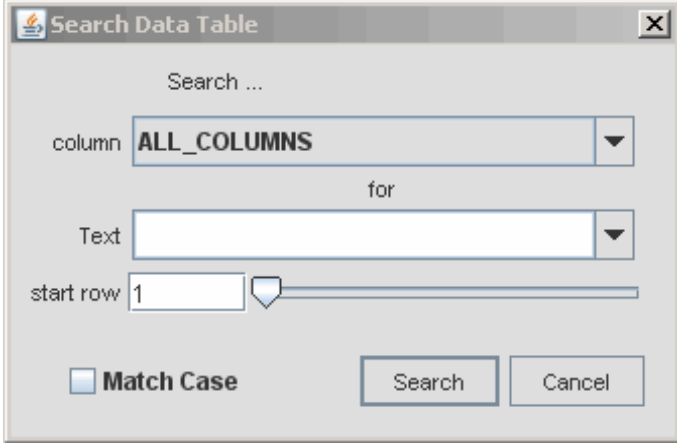
At this point, the user would normally click **Add/Remove Devices** at the bottom of the window and create a set of devices to include in the application. However, the user can also go to the pull-down menus and select *Application Manager*, which lists all the applications available for the device, as shown in the following figure.

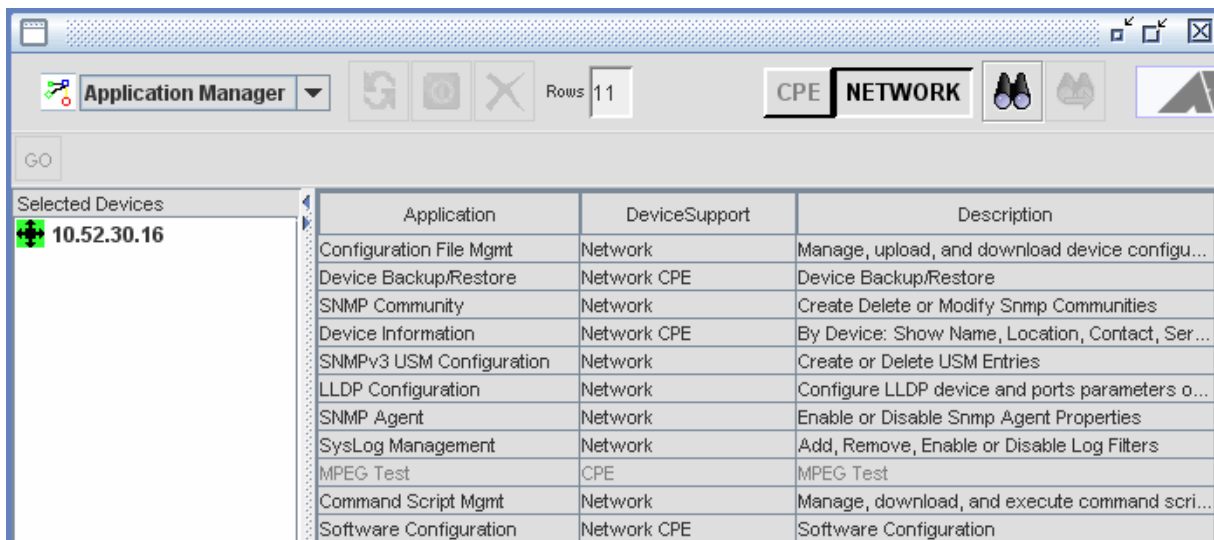

FIGURE 5-9 Selecting the Application Manager to View all Applications

Many of the buttons are grayed out because an application has not been selected. At this point, the user can double-click on one of the Applications in the table (or select the application, and then click **GO**) and it will invoke the specific application window.

If the user clicks **Add/Remove Devices**, which is at the bottom of every application window, the set of devices that are to be included in the application can be controlled, as shown in Figure 5-10.

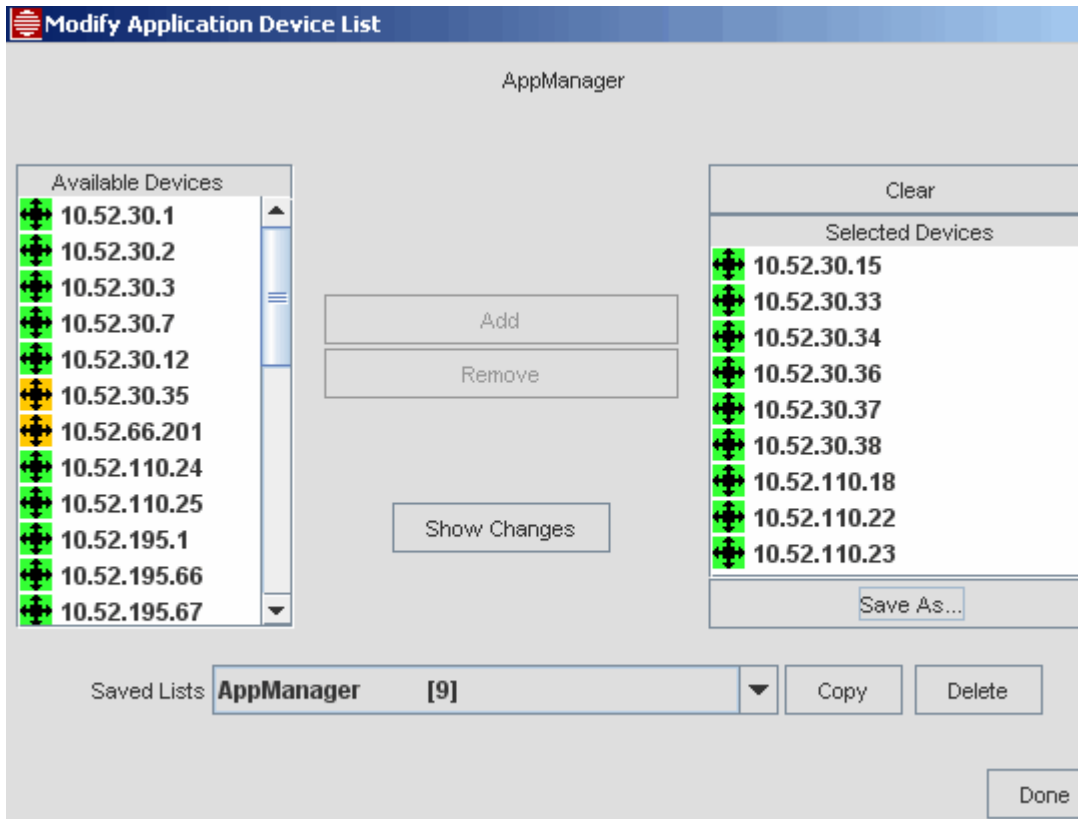

FIGURE 5-10 Add / Remove Devices for an Application

Table 5-3 lists the options for the **AppManager** window. Clicking **Done** closes the window.

TABLE 5-3 Options for the Add / Remove Devices for an Application

Option	Description
Available Devices	Available devices for the application are in black.
Clear	Clear all devices from the Selected Devices list.
Add / Remove	Sends a device from one column to another.
Show Changes	Brings up a window that shows which devices were added or removed from when the window was first invoked.
Save As...	Saves the currently displayed Selected Devices list to be recalled at a later time.
Saved Lists	Is a drop-down list of saved lists created with the Save As button. Selecting a saved list and then clicking Copy will copy the devices in the saved list to the Selected Devices panel. The number of devices in each list is indicated in square brackets to the right of the list name. The saved list also contains the list for each application so they can be copied to other applications.
Copy	Copies the devices in a saved list to the Selected Devices panel.
Delete	Delete the selected Saved List
Done	Makes the changes and puts the devices in the application window.

Another option to control the set of devices to be included in an application occurs when moving from one application (or the AppManager) to another, and the target Applications List is different (but not empty) from the source Applications List. The **Copy Device List** window appears, as shown in [Figure 5-11](#).

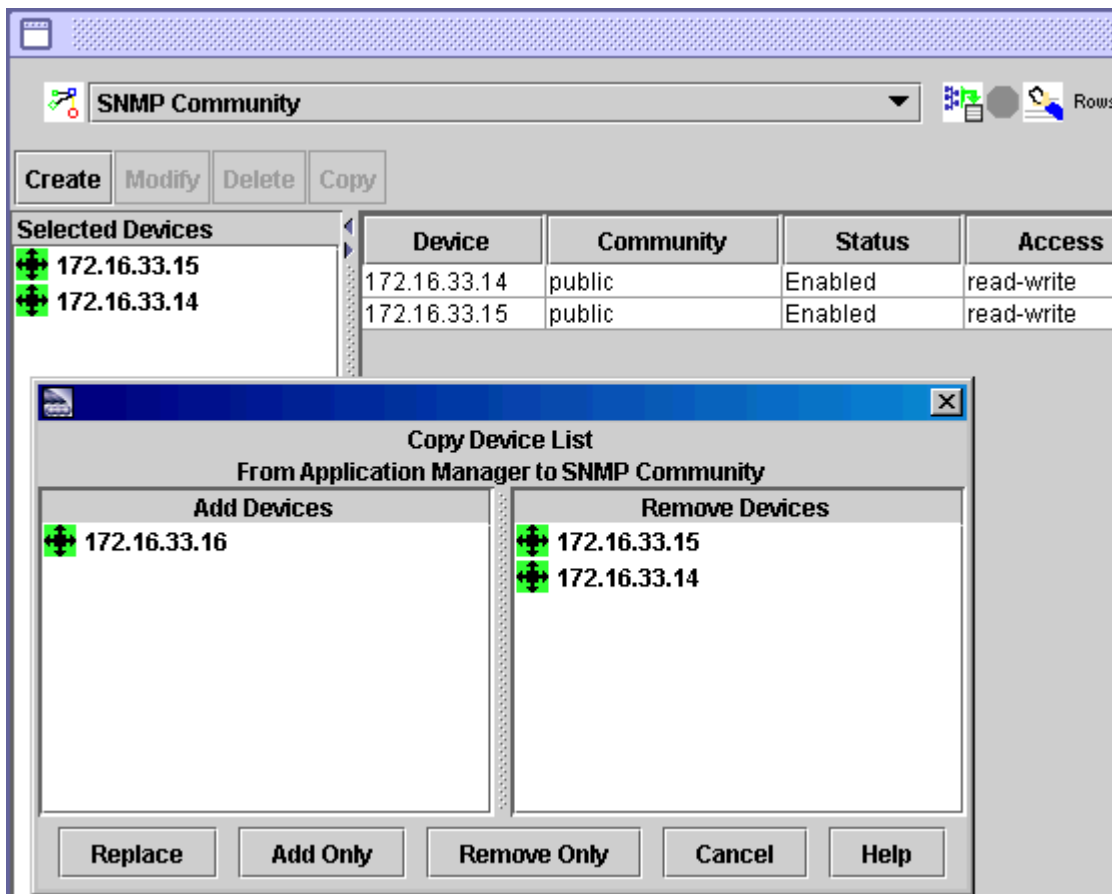

FIGURE 5-11 Copy Device List for an Application - File

The example shown in [Figure 5-11](#) would occur if the user has previously collected data for devices 172.16.33.14 and 172.16.33.15, and then right-clicks device 172.16.33.16 for the SNMP Community application. The Application window appears showing the devices that have already had data collected, and the **Copy Device List** also appears with the following options:

- **Replace** - Replace the target application device list with the source application device list. In this case, the 172.16.33.14 and .15 devices are replaced with the .16 as a Selected Device.
- **Add Only** - Add the .16 device to the other two devices.
- **Remove Only** - Remove devices from the target list that are not in the source list. In this case, the .14 and .15 devices would be removed.

5.3.2 Backup/Restore (with Purge Button)

5.3.2.1 Overview

The *Device Backup/Restore* option creates a current configuration data backup file for each managed device.

Note: Devices selected that are not supported will not appear in the **Selected Devices** list when the Device Backup/Restore application is selected.

The user can add or remove devices to the list of selected devices, as explained in [5.3.1](#). Once all of devices for the device backup restore are in the Selected Devices column, click the **Collect Data** icon. The AlliedView NMS begins gathering data, the **Stop** icon is highlighted, and as the data is collected they are added to the device table, as shown in the following figure.

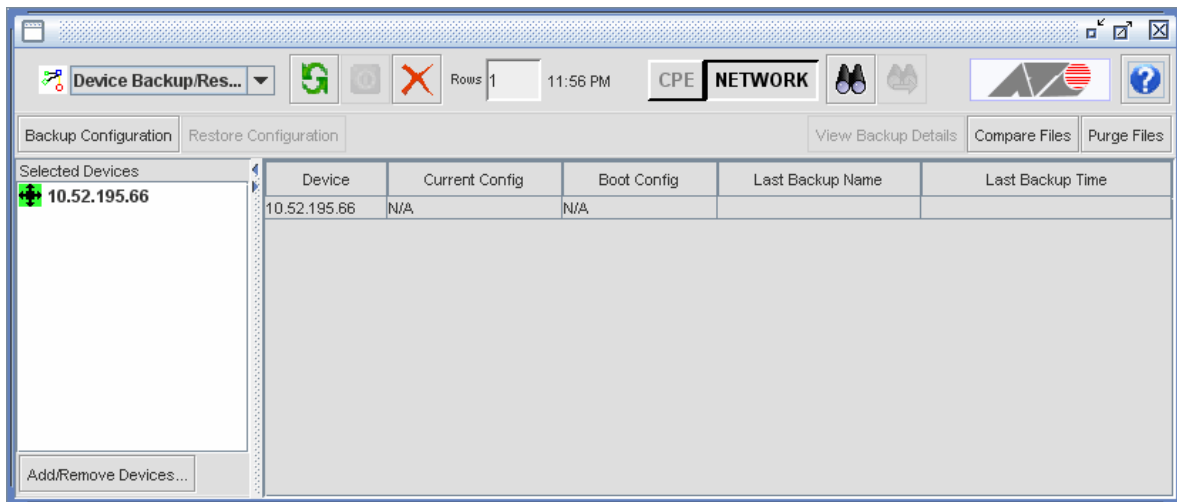

FIGURE 5-12 Collected Data for Selected Devices for Device Backup Restore (Network Selected)

Note: If for any devices the data cannot be collected, the row is dark; the Tooltip for that row will include the reason, such as "Unable to Connect."

5.3.2.2 Performing Backups

At this point the user can perform the following:

- Select multiple devices and perform a backup only.
- Select one device and perform a backup or restore.

Figure 5-13 shows the initial backup window, while Table 5-4 describes the fields.

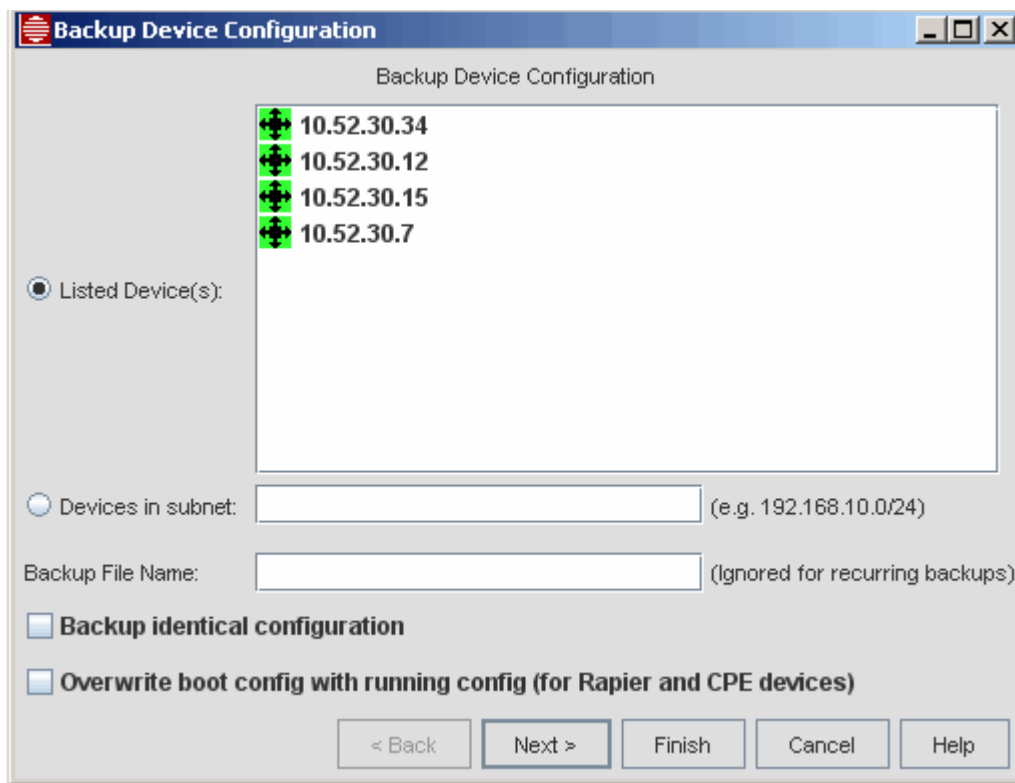

FIGURE 5-13 Initial Backup Window

TABLE 5-4 Backup Device Configuration Fields

Field	Meaning
Listed Device(s)	Device(s) that will have a backup created.
Devices in subnet	Backs up all devices for the specified subnet. The query is done when the task is executed, so that for a recurring task, new devices added since that task was created will be backed up during the next execution of the task.
Backup File Name	Descriptive name for the backup file. If the filename is not specified, the filename is generated by the NMS and will include the date and time of the backup.
Backup identical configuration	When checked, backs up and saves configuration files for devices where the files have not changed. The default is not to save identical configuration files (the tic box is not checked).
Overwrite boot config with running config (for Rapier and CPE devices)	Make the current configuration (reflected in the configuration database) the default. This applies to Rapier and CPE devices only.

Note: If you have modified your network configuration for Rapier or CPE devices, such as adding or modifying VLANs, you should back up your configuration information as soon as possible. Make sure the **Overwrite boot configuration file with running configuration** checkbox is checked.

If the backup is to occur now, click **Finish**. For scheduled or Recurring backups, click **Next**, and the **Recurring Schedule** window will appear, as shown in the following figure.

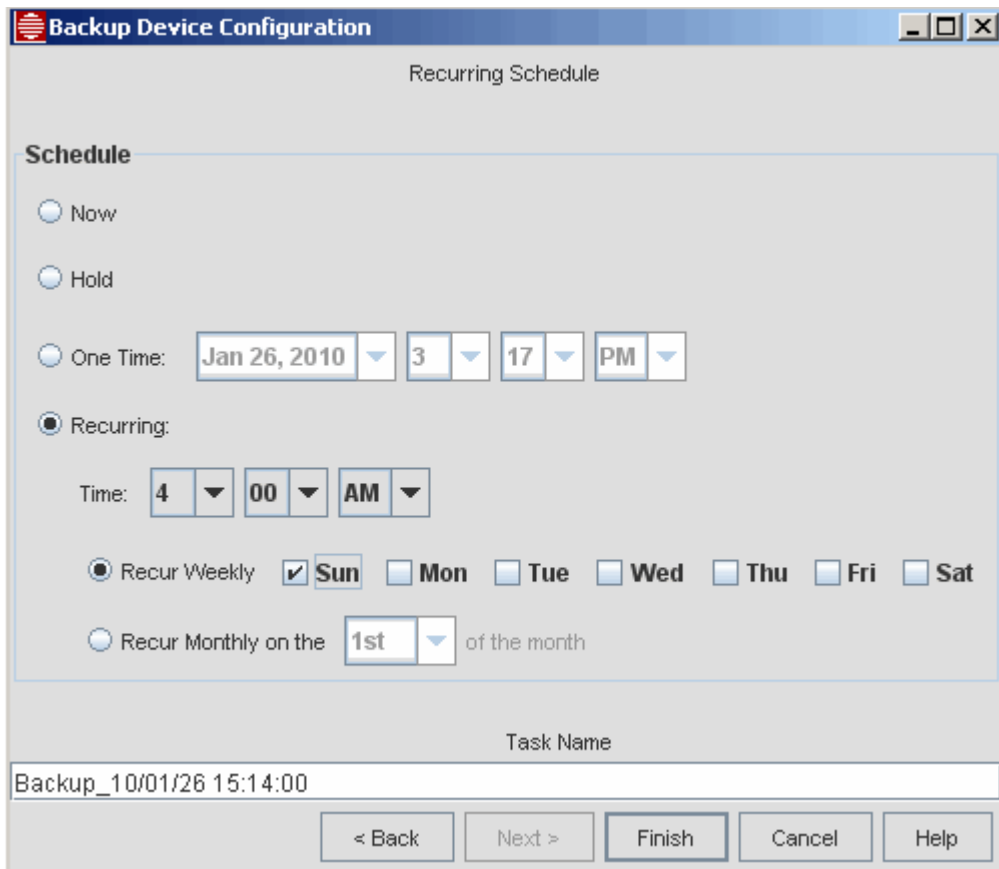

FIGURE 5-14 Recurring Backup Schedule Window - File

In [Figure 5-14](#), the backup has been scheduled for Sunday morning at 4 a.m. every week. Clicking **Finish** adds the backup to the schedule.

Note: It is highly recommended that you configure your device configuration backup to run on a recurring schedule to preserve configuration changes made by the NMS. If a device reboot or, in the case of iMAP devices, a database purge occurs, any configuration data that is not backed up will be lost. With regularly scheduled backups, should such an event occur, you can restore your configuration changes from the backup files.

5.3.2.3 Restore Configuration (Options Depend on Device Type)

Once a device or set of devices has a backup file, it can be restored. Select a device that has a backup file and click **Restore Configuration**. One of the following figure appears, depending on the device to be restored.

For Rapier/Switchblade devices only, the Rapier/Switchblade options are enabled, as shown below.

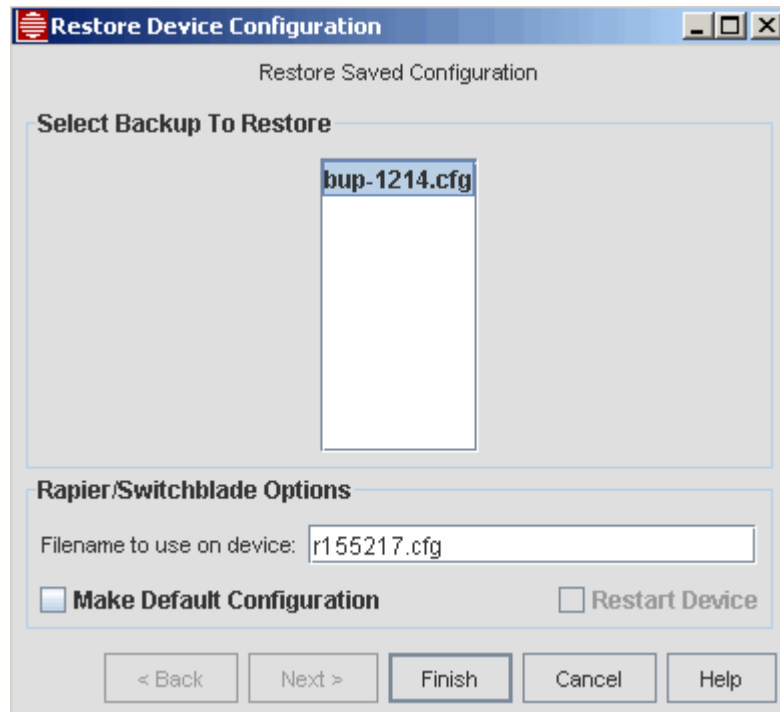

FIGURE 5-15 Restore Configuration for Rapier / SwitchBlade Devices Only

For iMAPs devices, the lower panel checkboxes are disabled, as shown below.

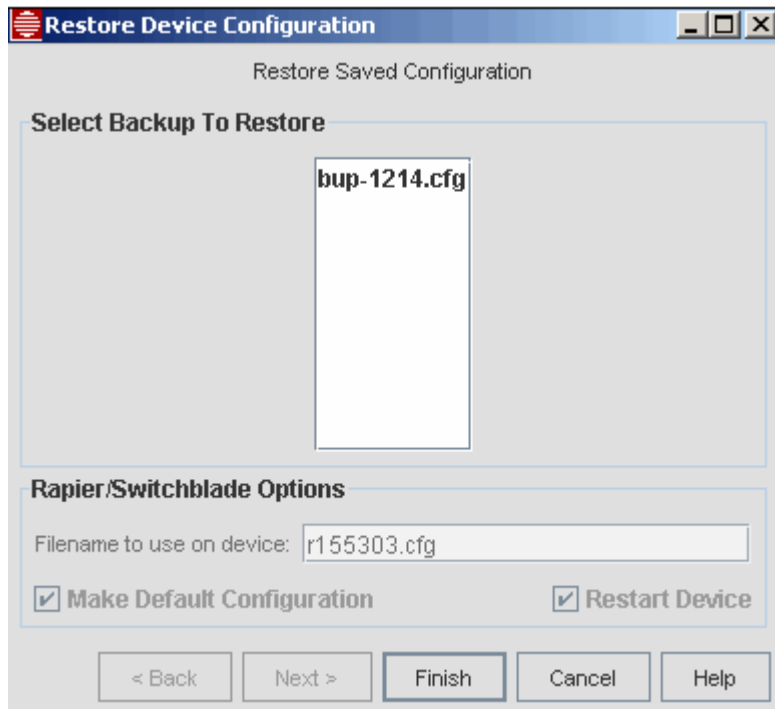

FIGURE 5-16 Restore Configuration for iMAP Devices Only

For iMAPS and Rapier/Switchblade devices, the Rapier/Switchblade filename option is enabled but checkboxes are disabled, as shown below.

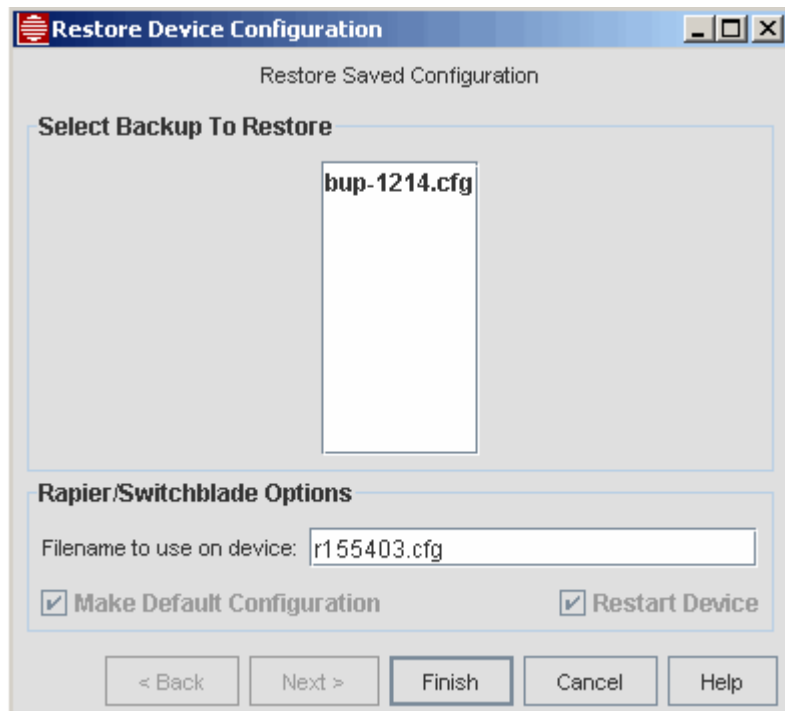

FIGURE 5-17 Restore Configuration for iMAP and Rapier / SwitchBlade Devices

For iMG/RGS only, these cannot be selected with iMAPs, Rapiers, etc, and the entire lower panel is removed, as shown below.

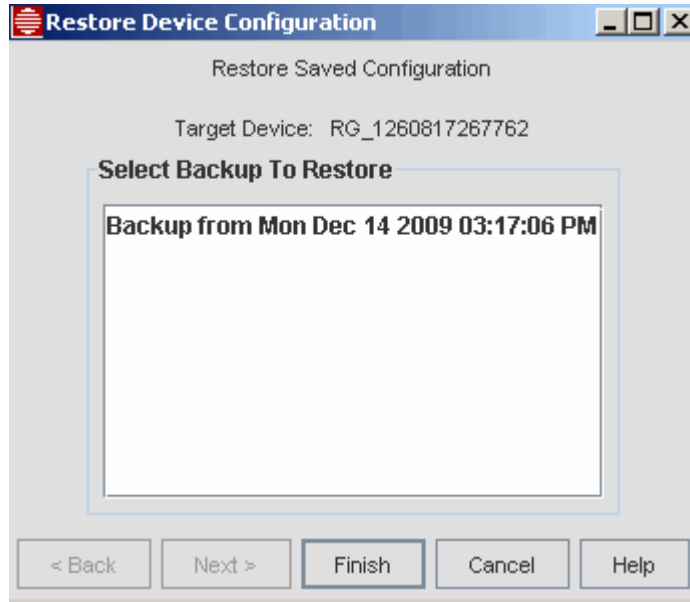

FIGURE 5-18 Restore Configuration for iMG/RG Devices

There is the option to make the restored file the default configuration. If this option is chosen, the **Restart Rapier** checkbox is active and can be used to restart the Rapier with the restored file.

The following table lists the options available.

TABLE 5-5 Restore Device Configuration Fields

Option	Description
Backup File	A list of files from which you choose the one to send to the device.
Filename to Use on Rapier	This field is filled in as you select a backup file. If the user didn't specify a filename for the backup, the entry will be "Backup from <date time>". Applies to all devices except iMG/RG.
Make Default Configuration	Checkbox that makes the selected file the default file (when device restarts, it will use this file). For Rapier / SwitchBlade devices only.
Restart Device	If the Make Default Configuration checkbox is checked, the Rapier device will restart immediately with the default file when the Apply button is pressed.
Apply	Applies the Changes.
Close	Closes the window. If the Apply button was not pressed, the options will not take effect.

5.3.2.4 Use of the Purge Files Option

The "Purge Files" button is added to the Device Backup/Restore panel to provide a way to activate on-demand purging and to configure the backup limit parameter using the NMS client.

Selecting the "Purge Files" button pops up a "Purge Backup Files" dialog, from which the user can enter the number of files to keep and whether or not to enable automatic purging for future backups. Refer to the following figure.

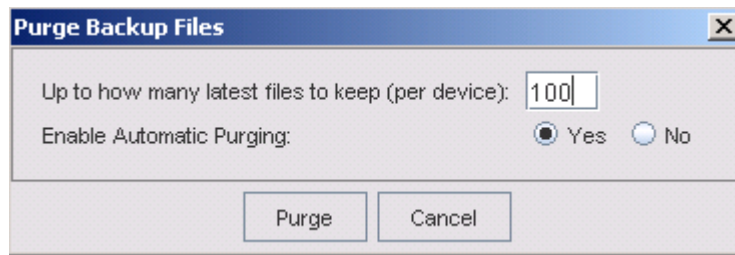

FIGURE 5-19 Purge Backup Dialog

Note: The value for what appears is from the `AT_NmsBackupFiles.conf` configuration file. The number must be greater than 0. Refer to 3.4.5.

The dialog includes a “Purge” button to activate purging and a “Cancel” button to dismiss the dialog without executing a purge.

Selecting Purge brings up the confirmation dialog. If the user confirms the operation, then all but the latest number of files per device will be deleted. Also, the `AT_NmsBackupFiles.conf` configuration file will be updated if a different value was entered (for example other than the 100 shown in the figure).

5.3.3 Command Script Management

Scripts are user-defined command (CLI) files. With the **Command Script Mgmt** window, the user can retrieve script files from a device or from the AlliedView NMS server, edit them in a multi-paged editor, and execute them. Moreover, the scripts can be executed on multiple devices at once.

Note: For Rapiet devices, significant configuration changes made using command scripts will not be reflected in the NMS until the devices are rediscovered. (Rediscovery can occur automatically as configured in Discovery Configurator or on demand by right-clicking a device and selecting Rediscovery.)

Figure 5-20 shows the **Command Script Mgmt** window after devices have been selected and data collected. Table 5-6 shows the fields and buttons available.

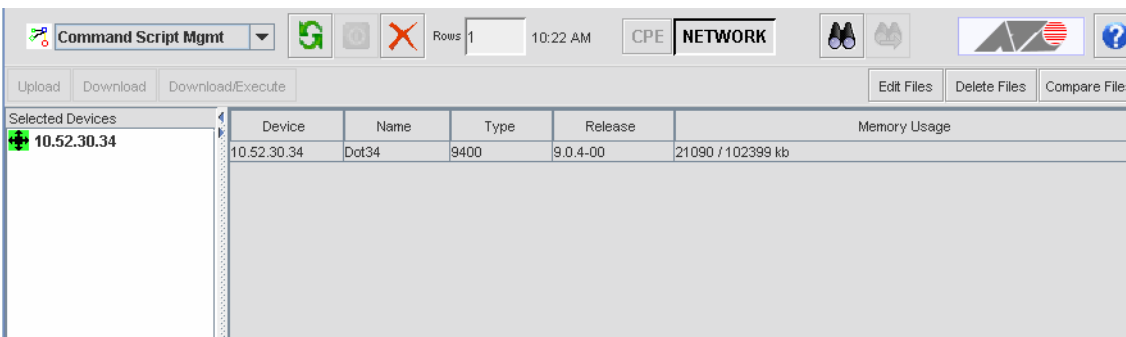

FIGURE 5-20 Command Script Mgt Window

TABLE 5-6 Command Script Mgmt Buttons/Fields

Button/Field	Description
Upload	Retrieves a file from the device. The user has to pick a file name from a list retrieved from the device. It can be stored either under the user's scripts path or under the user's device-specific in the server-side file system. Refer to 5.3.3.1 .
Download	Brings up a file chooser so a file can be selected from the server file system to be downloaded all the highlighted devices. If a file already exists with the same name, it will be overwritten. This button allows files to be downloaded without being executed as a script. One use of this button is to create a login banner file, as shown in 5.3.3.6 .
Download/ Execute	Brings up a file chooser. A script can be selected from the server file system for execution on all the highlighted devices. After the user chooses a script, it can be downloaded on all the target devices and executed. Command feedback from the devices will be displayed in a scrolling panel. Upon completing execution, the device needs to be rediscovered in case any configuration changes were made that may affect other NMS features, like VLAN. Refer to 5.3.3.2 .
Edit Files	Brings up the unloaded multi-paged editor. The editor has open and save as buttons that work with either the local file system or the server file system, determined by a toggle on the file chooser. (Local file system is not supported in rev. 2.0) Save uses whichever file was opened, whether local or server-side. The editor also have find, find next, and cut/copy/paste. Refer to 5.3.3.3 .
Delete Files	Brings up a file chooser from which the user chooses one or more files to delete. Refer to 5.3.4.2 .
Compare Files	Compares and displays two text files for comparison. Refer to 5.9.3

5.3.3.1 Upload File Form (Script Mgt)

The **Upload File** form is used to retrieve a file from the device. The user has to pick a file name from a list retrieved from the device. It can be stored either under the user's scripts path or under the user's device-specific directory in the server-side file system. Refer to [Figure 5-21](#).

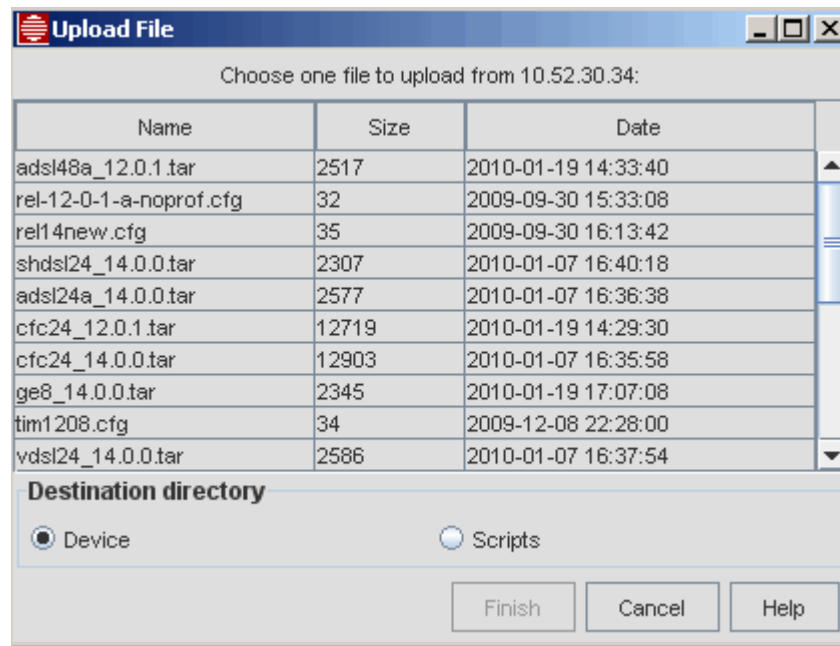

FIGURE 5-21 Upload Window for Script Mgt Files

5.3.3.2 Download/Execute

To download and then execute script files, select one or more devices in the **Command Script Mgmt** window and click **Download/Execute**.

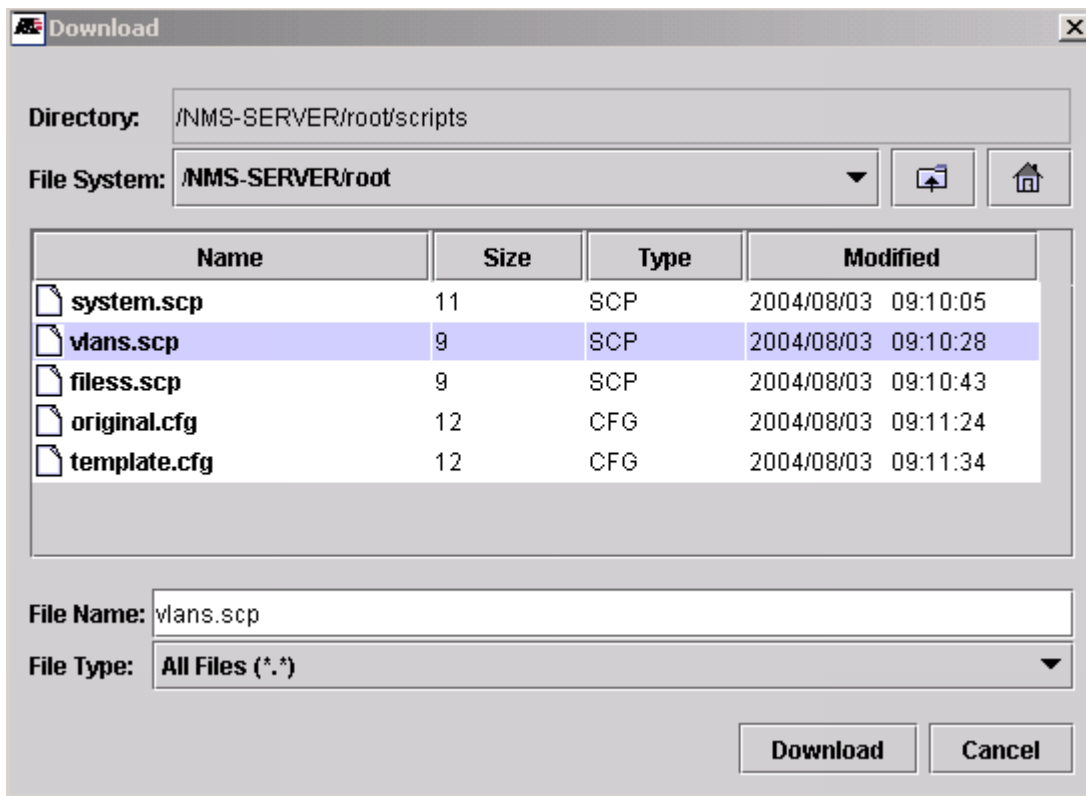

FIGURE 5-22 Download Window

After finding the appropriate file and clicking **Download**, the **Download Command Script** window appears, which lists the devices the script will be execute on, as shown in the following figure.

Note: The blank field allows the user to specify a filename to use on device in case the server-side name is too long, missing the extension, etc. The extension **must** be .scp.

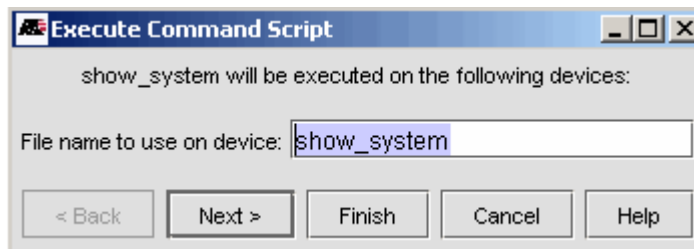

FIGURE 5-23 Execute Command Script

Click **Next** to bring up the Schedule Panel, where the user can select Now (default), One Time (Schedule) or Recurring date/time.

Clicking on **Finish** begins execution immediately (Now).

After clicking **Finish**, the script executes on the selected devices and the **Command Output** window shows the progress of the script execution. Refer to [Figure 5-24](#).

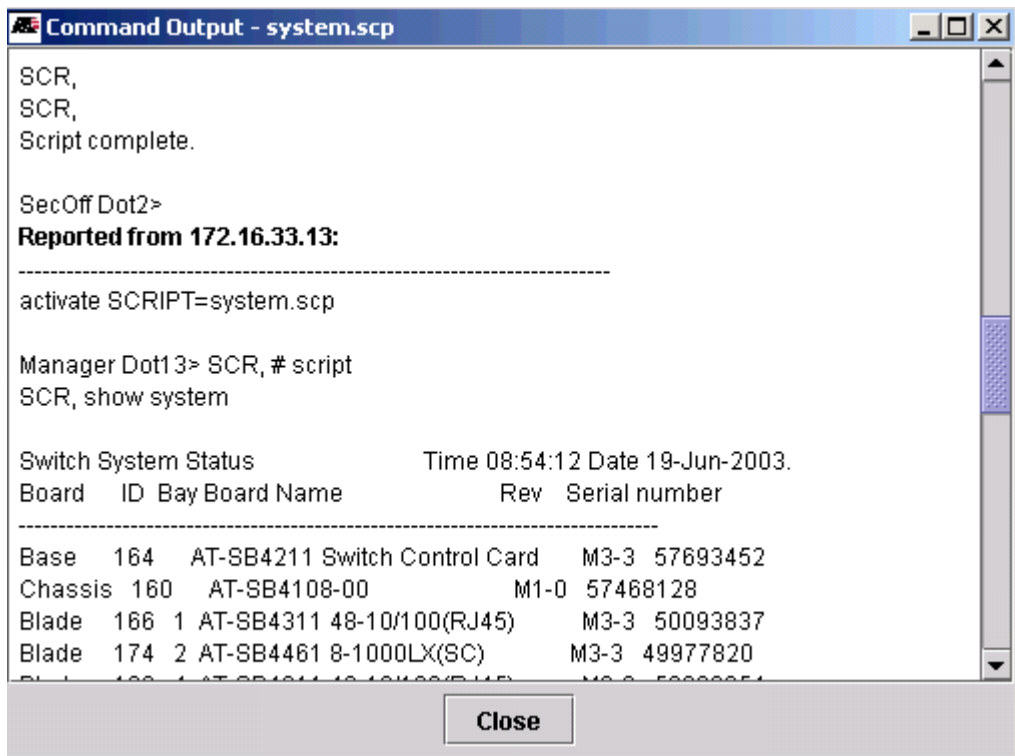

FIGURE 5-24 Command Script Execution

If the network connection to the device is lost or the script fails to complete, the error **Connection Lost or script not completed** may appear in an Errors window and in the Command Script window, as shown in the following figure.

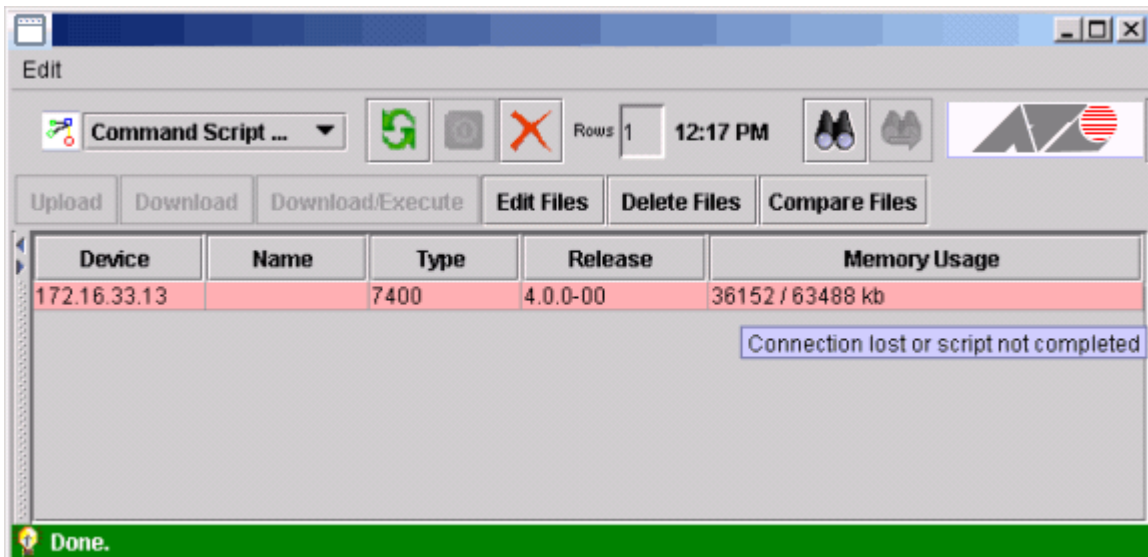

FIGURE 5-25 Failure to Run Script

Whatever script output received up to the point of failure will be displayed in the Output Window.

Note: Since it takes several minutes before a connection times-out, there will likely be a large amount of script output (1-2 megabytes or more), which may be difficult to read. Therefore lengthy scripts should be avoided when possible.

5.3.3.3 Edit Files

The **Edit Files** button brings up the unloaded multi-paged editor, from which command scripts can be written, saved and edited. The Edit window functions are described in [5.3.15](#).

For command script files, the Editor displays the contents of a Command Line Interface (CLI) script. The script file contains one or more CLI commands. Comments are identified as a hash (#) as the first character on a line. A CLI command in the script file must occupy a single line. A command cannot span more than one line. If a command requires user interaction, such as a confirmation, the user response text is included on the line after the command.

Following is a summary of the rules for creating and editing scripts:

- The commands in the script file must be syntactically correct.
- Each command must be on ONE LINE only. In other words, there is no continuation character.
- For iMAP devices, the first line of the script file must be a comment line with the word “script” in it. This is used to verify that a file is a valid script file. It is used to prevent the execution of a non-script file (i.e. load file).
- If a command returns a failure response, the script will continue to process commands following the error. It will not exit due to a parsing error OR command failure.
- If a command requires a confirmation string, the NEXT LINE must be a ‘Y’ to provide the confirmation response. If something other than a Y or N is provided, the script will quit.
- The user can provide comments (prefaced with a #) and blank lines in script files.
- The commands used must be within the realm of the user (i.e. Security Officer, Manager, User).

The contents of a script file are played back as written. Any syntax errors in the file are detected as the script is run. If an error is encountered, the device under maintenance is left in an unknown condition

5.3.3.4 Delete Command Scripts Option

The **Delete Files** button brings up the unloaded multi-paged editor, from which command scripts can be written, saved and edited. The Edit window functions are described in [5.3.16](#).

5.3.3.5 Compare Files

The **Compare Files** button brings up the File Comparison window, and is explained in [5.9.3](#).

5.3.3.6 Creating a Login Banner on a iMAP Device

Command script management can be used with iMAP Devices to create a login banner. Here are the steps:

1. Use **Edit Files** to create the login banner or message-of-the-day file. This is just a text file, for example:

```
*****
**                               **
**   HELLO WORLD   **
**                               **
*****
```

2. Save the file as `motd.txt`.
3. Use **Download** to download `motd.txt` to selected iMAP devices.
4. Use **Edit Files** to create a Allied Telesis script file that assigns the login banner file, for example:

```
# script
set loginbanner file=motd.txt
```

5. Use **Download/Execute** to download and execute the script on the selected iMAP devices.
6. Test by telnetting to one of the selected iMAP devices and observe the login banner.

5.3.4 Configuration File Management

For Rapier and iMAP devices, the configuration file is an ASCII-formatted file that contains the complete configuration of the device. When the device is rebooted, the configuration file can replace the currently active (running) configuration.

Note: Significant configuration changes made using configuration files will not be reflected in the NMS until the devices are rediscovered. (Rediscovery can occur automatically as configured in Discovery Configurator or on demand by right-clicking a device and selecting Rediscovery.)

After selecting the application **Configuration File Mgmt** and collecting data for the selected devices, the user will see the panel shown in [Figure 5-26](#). [Table 5-7](#). shows the fields/buttons available.

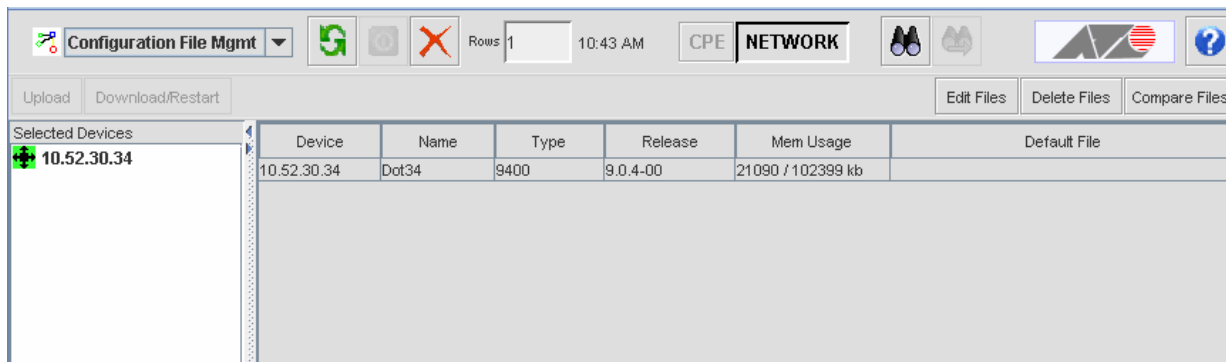

FIGURE 5-26 Configuration File Mgt Panel

TABLE 5-7 Configuration Mgt Buttons/Fields

Option	Description
Upload	This brings up the Upload Config Files Form, which allows the user to back up the file to a directory on the AlliedView NMS server. Refer to 5.3.4.1 .
Download/Restart	This brings up the Download Config File form, which allows the user to restore a configuration file. Refer to 5.3.4.2 .
Edit Files	This brings up the multi-paged text editor Refer to 5.3.4.3 .
Delete Files	This brings up a directory window, which allows the user to delete a file. Refer to 5.3.4.4 .
Compare Files	This brings up the File Comparison tool. Refer to 5.9.3

5.3.4.1 Upload Config Files Window

The **Upload Config Files** window provides a backup function. The filename is optional. If left blank, a name will be generated based on the date and time. If a filename is entered by the user, any name is allowed since it will be saved on the server file system.

If multiple devices are selected, their configuration files will all be stored using the same filename, with each file under its device name. Refer to [Figure 5-27](#).

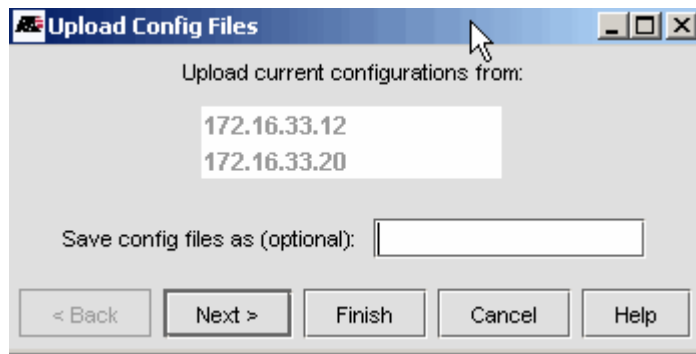

FIGURE 5-27 Upload Window for Configuration Mgt Files

Click **Next** to bring up the Schedule Panel, where the user can select Now (default), One Time (Schedule) or Recurring date/time.

Clicking on **Finish** begins execution immediately (Now).

Note: Blank names are suitable for recurrent uploads since new names will be chosen by the system as uploads are performed. If you enter a name and specify recurrent uploads, the same name will be used and the files will be overwritten.

5.3.4.2 Download Config File Window

The **Download Config File** window provides a restore function. The user is prompted to select a file name from a list of files for the highlighted devices. This window works as follows:

- All files with the same names for the selected devices are displayed.
- One commonly-named set of files can be selected for download to selected devices. If any device doesn't have a file name shared by all the others, then none will be available for selection. When this happens, the list will be initially empty.
- When downloaded, separate files are downloaded from respective device-specific directories to each device. The files may be renamed during download by entering a new name in the text field below the table. If the name is incorrectly formatted, download attempts will be cancelled and an error message will popup.
- The Source directories option determines whether they are downloaded from the **backup** subtree or from the user's (root) device subtree. When the source directory is changed, the list of files will change accordingly. Whenever such a change results in an empty list, a warning message will appear.

*Note: If one or more iMAPs are included in the device selection, the **backup** option is unavailable, since Configuration File Management is for text-based files, and iMAP backup files are database files in binary format. The user's subtree will contain the text config files that were uploaded using this application.*

- If **Make default configuration** is selected, the downloaded files will become the default configurations on the devices (applied the next time the devices are rebooted).
- If **Restart** is selected, the device will be rebooted upon completion of the download

Note: Once the download is complete, rediscover the device to ensure the data in the configuration file is communicated to the AlliedView NMS.

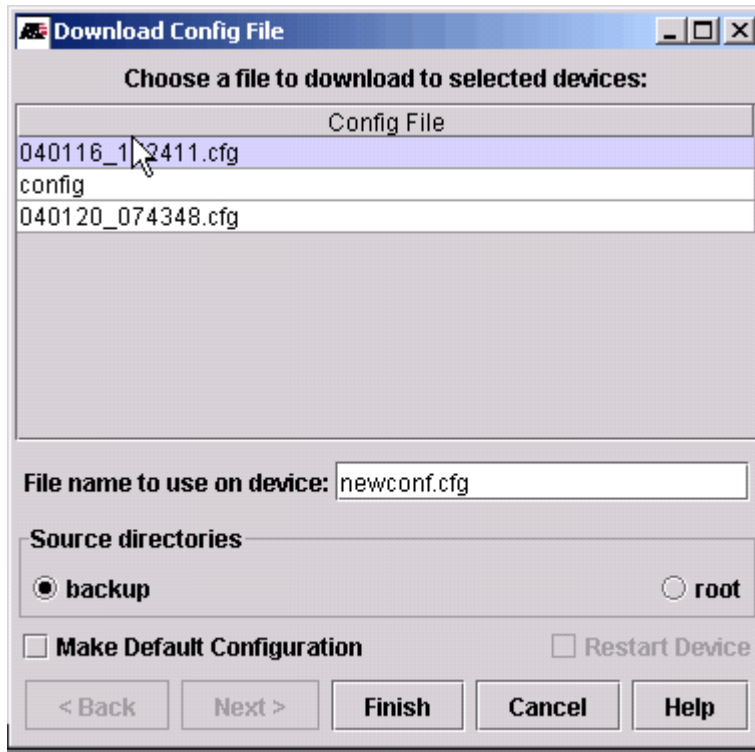

FIGURE 5-28 Download Config File Form - From Backup Directory

5.3.4.3 Edit Window

This **Edit** window has the same functions for Configuration and Script files, and is described in 5.3.15.

5.3.4.4 Delete Window

The **Delete** window brings up a list of configuration files for the selected device(s), from which the user may delete, and is described in 5.3.16.

5.3.5 Device Information

This application allows identification information (name, location, and contact information) to be changed. After selecting the application and collecting data for the selected devices, the user will see the following figure.

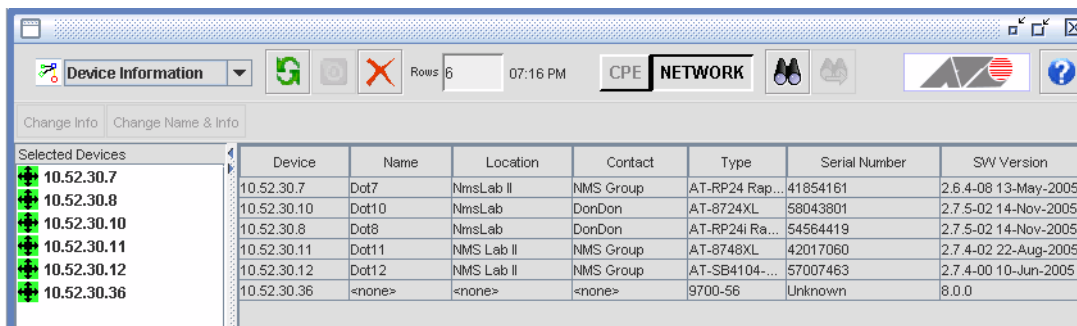

FIGURE 5-29 Device Information Application

When one device is chosen the **Change Name & Info** button is activated, and clicking it brings up the **Change Device Information** window, as shown in Figure 5-30. (Double-clicking the device row will also bring up this form.)

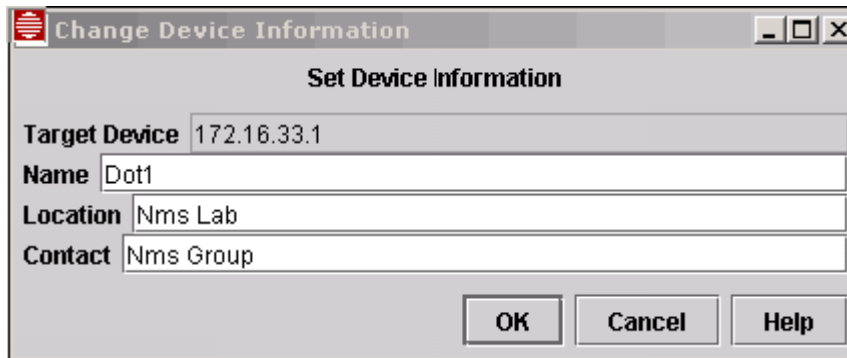

FIGURE 5-30 Change Device Information Window

In this window the **Name**, **Location** and **Contact** can be changed.

When more than one device is chosen, the **Change Info** button is activated; clicking it also brings up the **Change Device Information** window, but only the Location and Contact information can be changed.

5.3.6 SNMP Agent

The Simple Network Management Protocol (SNMP) involves the device agent, which controls the managed objects in the device.

This application is used to configure the SNMP agent that sends SNMP traps to the AlliedView NMS or other hosts, as well as configure SNMP communities.

When the SNMP Agent application is chosen the following figure appears.

Note: When going from one application to another, and the next application has not yet been used, the devices that were in the first application are carried over to the second, which is why the three devices from backup/restore are now selected in the **SNMP Agent Panel**.

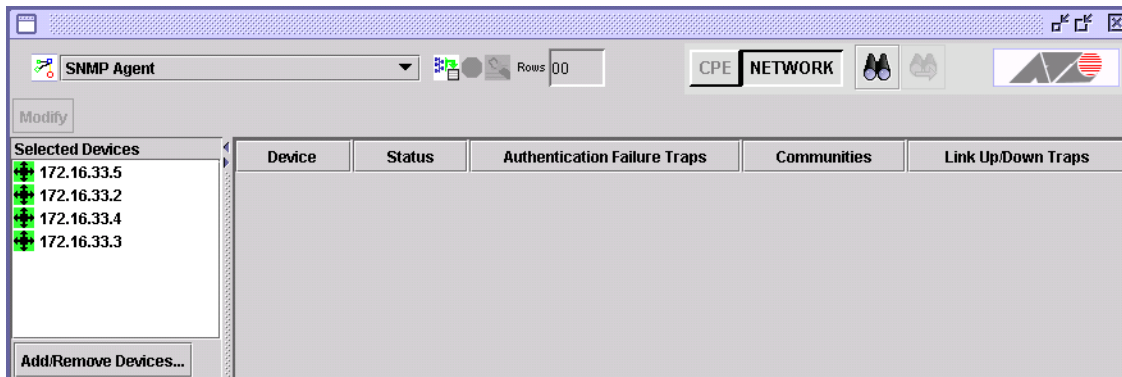

FIGURE 5-31 SNMP Agent Panel - Initial View

After clicking **Add/Remove Devices**, (if necessary) and clicking the **Collect Data** icon, data is gathered for the devices and the following figure appears.

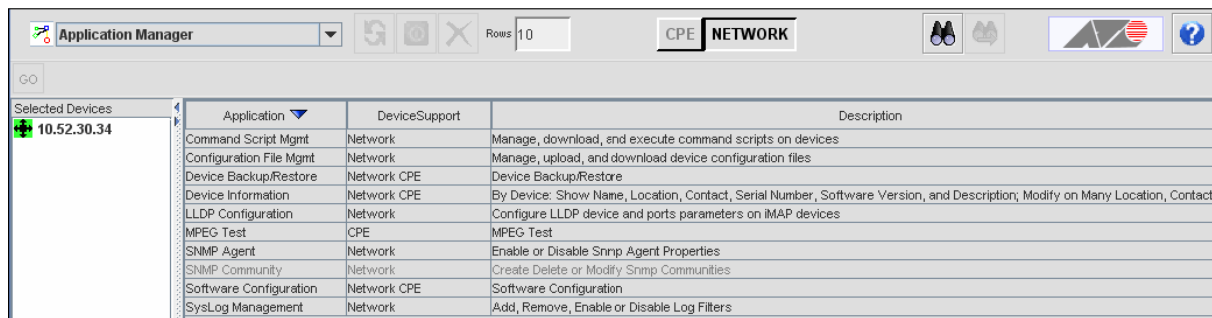

FIGURE 5-32 SNMP Agent Panel

To modify the agent for one or more devices, select the rows, and then click **Modify** (now active). The following figure appears.

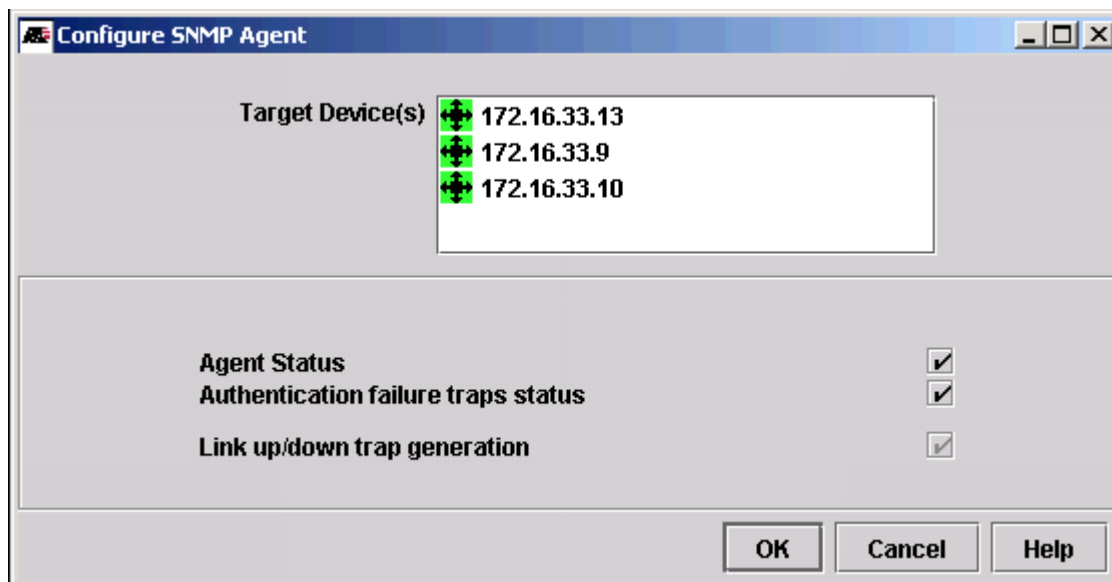

FIGURE 5-33 Configure SNMP Agent Panel

The following table lists the options available.

TABLE 5-8 SNMP Agent Fields

Option	Description
Agent status	A checkbox to enable or disable the device(s). A dark check means all selected devices have this feature enabled, an unchecked box means no devices have this feature enabled, and a gray checkbox means some devices have this feature enabled and some devices do not.
Authentication failure traps status	A checkbox to enable or disable the create traps when an unauthorized attempt has been made.
Link up/down trap generation (all interfaces)	A checkbox to set each interface to send (checked) or not send (not checked) a trap when its up/down state changes. A gray box means no changes are made.
OK	Applies the changes.
Cancel	Cancels the changes made in this window.
Help	Invokes online help.

5.3.7 SNMP Community

An SNMP community helps to define the relationship between the AlliedView NMS and the Management Information Base (MIB) of the device, in essence defining the operations that can be performed on various objects in the device. For each device there may be multiple communities, with each community providing a set of operations.

Caution: *In SNMP, a community name acts as a password; if the community includes write operations, it is possible for other applications to use the community name and change the values for a switch configuration.*

When the *SNMP Agent* application is chosen and the **Collect Data** icon is clicked, the following figure appears.

Device	Community	Status	Access	Open Access	Traps Status	Manag
10.52.30.10	public	Enabled	read-only	yes	Disabled	
10.52.30.11	public	Enabled	read-only	yes	Enabled	
10.52.30.11	private	Enabled	read-write	yes	Disabled	
10.52.30.7	public	Enabled	read-only	yes	Enabled	
10.52.30.7	private	Enabled	read-write	yes	Disabled	
10.52.30.8	public	Enabled	read-only	yes	Disabled	

FIGURE 5-34 SNMP Community Panel

At this point a new community can be created, or the devices can be selected and the community settings can be modified, removed, or copied. The **Create**, **Modify**, and **Copy** buttons perform these functions. The following figures shows the **Create**, **Modify**, and **Copy** SNMP Community forms, which are displayed when these buttons are clicked.

Caution: *Creating, modifying, and deleting SNMP Communities for devices managed by the AlliedView NMS must be done via the AlliedView NMS and not the device CLI. Making changes using the device CLI will cause a data mismatch between the device and the AlliedView NMS database. If you must make changes using the device CLI, you must also make the changes in the AlliedView NMS.*

Create Snmp Community

Target Device(s)

- 10.52.30.15
- 10.52.30.33

Required Properties

Community Name

Use this community for NMS

Optional Community Properties

Open Access Status Enabled

Write Access Enabled Traps Enabled

Manager Destination	
IP Address	
NMS-SERVER	

Trap Destination	
IP Address	Snmp Version
NMS-SERVER	V1

OK Cancel Help

FIGURE 5-35 Create SNMP Community Form

Modify Snmp Community

Target Device(s) **10.52.30.33**

Select Community

Community Name **public**

Use this community for NMS

Optional Community Properties

Open Access Status Enabled
 Write Access Enabled Traps Enabled

Manager Destination

IP Address	Snmp Version
10.52.18.91	V1
10.52.18.80	V2C
10.52.18.94	V2C
10.52.18.216	V2C

Trap Destination

OK Cancel Help

FIGURE 5-36 Modify SNMP Community Form

When the **Copy** button is clicked, a two-page form appears. Both pages are shown in the following figures.

Copy Snmp Community

Copied SNMP Communities

Communities **notpublic**

Details

< Back Next > OK Cancel Help

FIGURE 5-37 Copy SNMP Community Form (First Page) - File

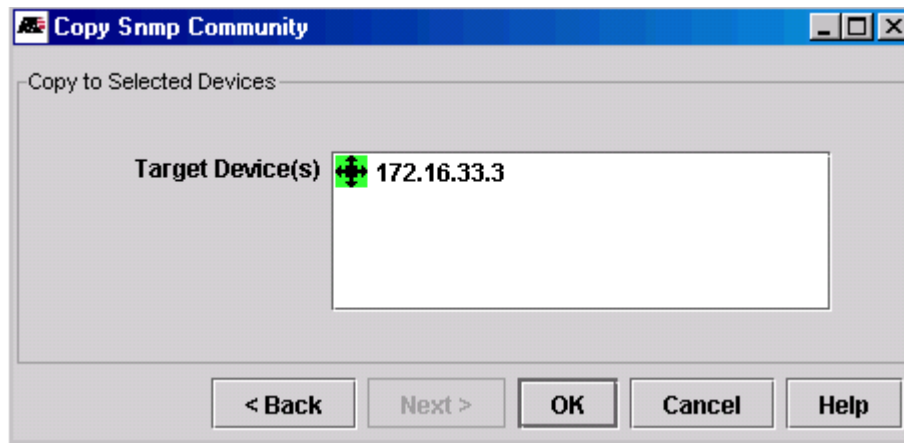

FIGURE 5-38 Copy SNMP Community Form (Second Page) - File

The following table lists the options available.

TABLE 5-9 Community Configuration Fields

Option	Description
Community Name	A text box when adding (creating) a community name, a drop-down of community names when modifying a community name. When adding a community, clicking on the Add/Remove button adds the community. If a community is already highlighted, clicking on the Add/Remove button will remove the community for the device.
Use this community for NMS	Make this community be used for SNMP communication.
Open Access	Checkbox to allow Open Access or not for this community.
Status Enabled	Checkbox to enable or disable status messaging for this community.
Traps Enabled	Checkbox to enable or disable the ability for this community to produce traps.
Write Access Enabled	Checkbox to enable Read-Only or Read-Write Access for this community.
Manager Destination	The IP address of the snmp Manager. If Open Access is not enabled (not checked), then GETs are only accepted from this IP address. If Open Access is checked, this field is not used. When the check mark is black, all Managers in the list are added to the devices. When the check mark is gray, only the new Managers in the list are added to the devices. If unchecked, no changes are made.
Trap Destination	The available trap host. This is the IP address where traps are to be sent, and the SNMP version (pull down) of which version. When the check mark is black, all trap hosts in the list are added to the devices. When the check mark is gray, only the new trap hosts in the list are added to the devices. If unchecked, no changes are made.
Help	Invokes context-sensitive online help.
OK	Activates changes.
Cancel	Cancels changes.

To delete a community, select one or more devices and click on **Delete**.

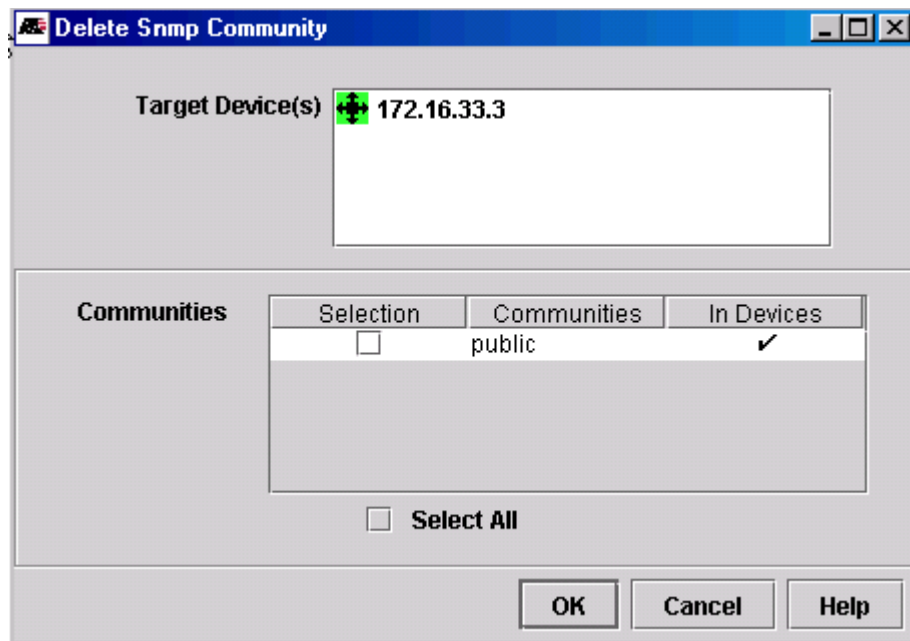

FIGURE 5-39 Delete Snmp Community Window

The user can then select the communities for the **Target Device** (or **Select All**) and by clicking **OK**, delete those communities.

5.3.8 Obtaining SW Loads

The user can go to the web site and get the appropriate files (xml/tar) they wish to use for their specific NMS configuration and place them in the <NMS_Home>/swdownload directory.

5.3.9 Software Configuration (Standard Loads)

When the *Software Configuration* application is chosen and the **Collect Data** icon is clicked, the following figure appears.

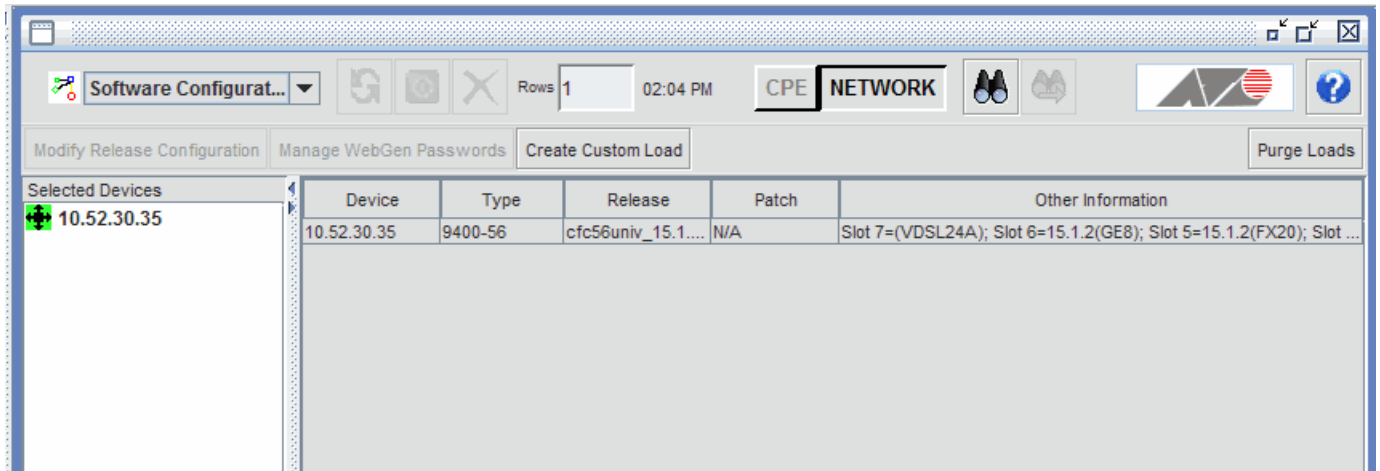

FIGURE 5-40 Software Configuration Panel

5.3.9.1 Firmware Decoupling Feature as part of Software Configuration

To reduce the install size for the NMS installation load, firmware loads for devices are separate from the installation load. The user instead adds device firmware loads to the NMS server.

Release files for closely related device types and releases are placed together as a **bundle**, so a file is a bundle that can consist of multiple groups placed together in one zip file. Within this zip file is an xml file that:

- Allows the NMS to determine compatibility for the file with the release installed on the NMS.
- Allows the user to identify the family, device types, versions, descriptions, and release date.

Moreover, when a point release is added, the NMS determines which versions are obsolete, so that only those current firmware loads are available and obsolete firmware loads can be purged.

The firmware is ready to load and use as soon as it is uploaded, without the need to restart the server.

The user adds a firmware file to the NMS by:

1. Learning about the latest firmware releases from ATI (such as iMAP 12.0.1 or AT-8600 2.8.1-01).
2. Obtaining the file(s) using an ftp/web site.
3. Transferring the file(s) to the NMS server.
4. Using the Software Configuration feature to add and delete files. The NMS looks at the downloaded files and determines which files are compatible, and can therefore determine which files can be downloaded onto the devices and which ones can be purged as obsolete.
5. The user chooses the Modify Release Configuration, and the files, if compatible, are included in the download.
6. The user can also choose the Purge Files option, in which the NMS highlights which files are obsolete and gives the user the ability to highlight all obsolete files which can then be deleted. (The user can still delete current files if desired.)

The rest of this subsection goes through the Software Configuration and highlights where the Firmware Decoupling feature is being used.

5.3.9.2 Modifying Software Configuration

The table shows for the selected devices all of the filetypes for the devices. When the user selects the devices and clicks **Modify Release Configuration**, the **Modify Release Configuration** form appears, as shown in the following figure.

Caution: For the devices that will receive downloads, do not set their telnet idle session time-out to any value less than 6 minutes. This minimum is needed to ensure the NMS is aware the download is complete and can proceed with any further steps.

Note: If a custom load has been built (refer to 5.3.10), it will be added to Loads pull-down.

Modify Device Software Configuration

Download New Release

Target Device(s)

10.52.30.35

Loads: Release 16.0.1

This will load the following releases:

SBx3100 devices: Release 16.0.1

iMAP devices: Release 16.0.1
(ADSL24 cards will be loaded with ANNEX-A software)

Delete old release files if memory space is insufficient

Delete currently installed files if memory space is insufficient

Load releases for installed card types only

Operation

Download new image(s) only

Apply new image(s) (This may cause the device(s) to reboot)

Commit: Apply new image(s) and set as preferred (This may cause the device(s) to reboot)
(Only Commit applies to AT-8000S, AT-8000GS, AT-8100S, AT-9000, CentreCOM-FS Series and Residential Gateways)

< Back Next > Finish Cancel Help

FIGURE 5-41 Modify Software Device Configuration Panel

Table 5-10 lists the options available.

TABLE 5-10 Software Download Buttons/Fields

Option	Description
Loads	A pull-down menu for choosing the software release for the device. For iMAP devices, the user can select loads that assume Annex A or Annex B cards are being loaded.
Delete old release files if space needed	A checkbox that tells the device to delete old release files before loading the chosen release file. (Note that you may need to check this box if a previous download of a release file to the device has failed.)
Delete current release files if space needed	A checkbox that is active only after choosing the checkbox to delete old release files, it tells the device to delete the current release file as well as old release files. (Note that you may need to check this box if a download of the release file using the first checkbox has failed.)
Load releases for installed card types only	This option appears whenever any of the target devices is an iMAP. iMAP devices may support numerous card types, and checking this option will only load the release files for currently installed card types, saving memory. If a new card type is installed afterwards, the downloads will have to be re-executed to update the release for the new card.
Operation	A set of radio buttons for choosing which download method to use. <ul style="list-style-type: none"> • Download new image(s) only places the selected image(s) on the device. • Apply new image(s) places the selected image(s) on the device and restarts the device with the downloaded image(s) only if necessary. When the device restarts again, it will revert to the previous image(s). • Apply new image(s) and set as preferred places the selected image(s) on the device and restarts the device with the downloaded image(s) only if necessary. When the device restarts again, it will keep the downloaded images as the active ones and not revert to the previous image(s).
Next	Brings up the schedule panel for recurring backups.
Finish	Submits the Task name and all options for processing immediately.
Cancel	Closes the window. If the Submit button has not been pressed, any changes to the form are lost.
Help	Invokes online help.

Note: When a device cold starts and sends a cold trap, the device will be automatically rediscovered within two minutes, so after a software download the information for a device will be automatically updated (although it may be out of synch for a short time).

Note: In the unlikely event of getting a “Required Anonymous FTP server is missing”, refer to the AlliedView NMS Installation Guide, section 9, Appendix A, Enabling Anonymous FTP.

Note: In the unlikely event of getting an “NMS File System Error”, see the trace log for more detailed and more specific error message. This error only occurs when NMS was not installed properly, the FTP service is not configured properly, the NMS file system is full or corrupt, or the NMS server account has been changed to revoke required read/write/delete file access privileges.

Note: For the SBx3112, selecting the standard Release Loads (currently 16.0.1) does not work, since for line cards there is for the 16.0.x release a common load including the text string sma (i.e. x31sma_16.0.1.tar). This will be fixed in a future release. Refer to 5.3.10 for building a custom load that includes this common file.

5.3.9.3 Purge Load Files

The Purge Load Panel lists all the load bundles and gives a summary of their contents. Older load bundles can be selected for deletion. **When deleted, all files making up the load bundle will be deleted.**

“Obsolete” bundles are bundles in which all files are superseded by 2 or more versions from other bundles. Any bundle can be deleted any time, but “obsolete” bundles are pre-selected for convenience.

The **Select Obsolete** button selects (checks) all rows containing obsolete bundles.

The **Clear All** button, un-selects (unchecks) all rows.

The **Delete Files** button deletes all files from all selected (checked) bundles. If any errors occur during the deletion, an error dialog will pop up with an error message.

Delete	Status*	Name	Family	Versions
<input type="checkbox"/>	Current	AT-8600-276	AT-8600	2.7.6-04, 2.7.6-00
<input type="checkbox"/>	Current	AT-8600-281	AT-8600	2.8.1-01, 2.8.1-00
<input type="checkbox"/>	Current	AT-8700-276	AT-8700	2.7.6-02, 2.7.6-00
<input type="checkbox"/>	Current	AT-8700-281	AT-8700	2.8.1-01, 2.8.1-00
<input type="checkbox"/>	Current	AT-8900-9900-276	AT-8900/9900	2.7.6-03, 2.7.6-00
<input type="checkbox"/>	Current	AT-8900-9900-281	AT-8900/9900	2.8.1-01, 2.8.1-00
<input type="checkbox"/>	Current	AT-9800-276	AT-9800	2.7.6-02, 2.7.6-00
<input type="checkbox"/>	Current	AT-9800-281	AT-9800	2.8.1-01, 2.8.1-00
<input checked="" type="checkbox"/>	Obsolete	AT-9900s-281	AT-9900	2.8.1-01, 2.8.1-00
<input type="checkbox"/>	Current	AT-9900s-300	AT-9900	3.0.2-06, 3.0.2-01
<input type="checkbox"/>	Current	AT-9900s-311	AT-9900	3.1.1-01, 3.1.1-00
<input checked="" type="checkbox"/>	Obsolete	AT-AR400-271	AT-AR400	2.7.1-06, 2.7.1-00
<input type="checkbox"/>	Current	AT-AR400-276	AT-AR400	2.7.6-02, 2.7.6-00
<input type="checkbox"/>	Current	AT-AR400-281	AT-AR400	2.8.1-01, 2.8.1-00
<input type="checkbox"/>	Current	AT-AR700-276	AT-AR700	2.7.6-02, 2.7.6-00
<input type="checkbox"/>	Current	AT-AR700-281	AT-AR700	2.8.1-01, 2.8.1-00
<input type="checkbox"/>	Current	RG-600-ADSL-34	iMG/RG-600 ADSL	3-4 57 11 01
<input type="checkbox"/>	Current	RG-600-ADSL-35	iMG/RG-600 ADSL	3-5 83
<input type="checkbox"/>	Current	RG-600-ETH-24	iMG/RG-600 ETH	2-4 58 02 03
<input type="checkbox"/>	Current	RG-600-ETH-25	iMG/RG-600 ETH	2-5 51
<input type="checkbox"/>	Current	Rapier-8800-276	Rapier/8800	2.7.6-02, 2.7.6-00
<input type="checkbox"/>	Current	Rapier-8800-281	Rapier/8800	2.8.1-01, 2.8.1-00
<input type="checkbox"/>	Current	Switchblade-274	Switchblade	2.7.4-02, 2.7.4-00
<input type="checkbox"/>	Current	Switchblade-275	Switchblade	2.7.5-02

*Considered "obsolete" if 2 or more newer releases or patches are present

Select Obsolete Clear All Delete Files Close

FIGURE 5-42 Purge Load Files

5.3.9.4 Using a MTAC Account and WebGen (Manual) to Enable Software Upgrades

To enable software upgrades for Rapier devices, a two-step process is used that involves tasks at an Allied Telesis website as well as a AlliedView NMS feature:

1. The Multi-Time-Access-Code (MTAC) is a website where customers can register themselves and then set up for their devices (based on the serial numbers) the OSs that will be loaded.
2. The **WebGen Import** Form tool (on the AlliedView NMS) is then brought up, and the results from the MTAC account are copied either directly into the form or are copied into a file so that it can be copied into the form later.

To access your MTAC account, go to <https://licence.alliedtelesis.co.nz/mtac/fusebox.cfm>.

Note: Before accessing this site, you will need to obtain a valid user ID and password from your authorized Allied Telesis representative or reseller.

Once you have accessed the site, you will go through a series of forms where you enter your id, password, give general customer details, and correlate an OS with the serial numbers of your devices. You must also fill in details on the device for each serial number. (Note that you do not have to enter information for all your devices and can revisit your account later.) After clicking on **Generate**, a list of ENABLE commands is produced that selects the OS for the devices and include the passwords.

Note: The instructions above are at a general level because detailed instructions about using your MTAC to generate licences are at www.alliedtelesis.co.nz/webgen/pdf/webgen-customer-guide.pdf.

Once you have this list of commands generated with the account, you can use the results in one of two ways:

- Save the html form as a filename. This file can then be transferred to the NMS if there is no internet access from the NMS server. The WebGen Import form is then used to access this file so it can be imported.
- The WebGen Import form is brought up and the results are pasted directly into the form and imported.

To access the WebGen Import Form, use the Start Menu and Select **Programs** -> **<NMS Load>** -> **Tools**. This will bring up the WebGen Import form shown in the following figure.

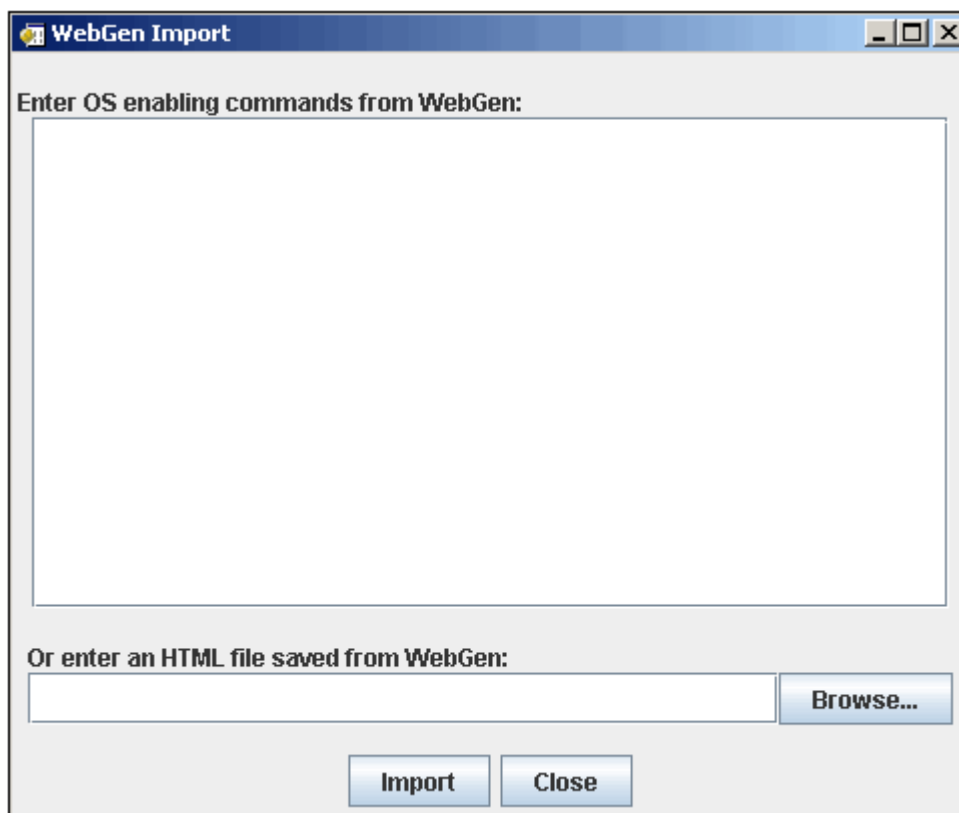

The image shows a Windows-style dialog box titled "WebGen Import". The main area is a large text box with the prompt "Enter OS enabling commands from WebGen:". Below this is a smaller text box with the prompt "Or enter an HTML file saved from WebGen:" and a "Browse..." button to its right. At the bottom of the dialog are two buttons: "Import" and "Close".

FIGURE 5-43 WebGen Import Form

To use the WebGen form directly, paste the results of the Generate command directly into the form and then Select **Import**. A pop-up window will appear indicating that the passwords were successfully imported, so that during software downloads performed at the NMS, the ENABLE commands with the passwords are already included.

To use a saved file, type in the name of the file or (more likely) use the **Browse** button and locate the file. Select **Import**, and the same message and action occurs as when using the form directly.

If any errors occur during parsing, a dialog box will appear indicating the error condition.

Note: To easily gather device attributes so they may be copied and pasted in WebGen, the user can create a Custom View of the Network Inventory/Nodes component and have only the selected devices with the

selected attributes appear. This would mean changing either the Select Props to View or Additional Props to match what you wish to capture. You can then select the row with the mouse, use Control-C to copy, then go to the appropriate window and Control-V to paste.

5.3.9.5 Using MTAC Accounts and WebGen (Automatic) to Enable Software Upgrades

The automatic interface is an automated way to simulate logging into the WebGen server, filling out and submitting forms to generate passwords, extracting results from the HTML returned by the server, and then logging out. Like the manual method, this is for AT devices only.

The WebGen interface is brought up as part of the Software Configuration. In the Software Configuration panel (Figure 5-40), The **Manage WebGen Passwords** button brings up the Manage WebGen Passwords Wizard for the selected devices. The wizard has these panels, which are explained below:

1. **Manage MTAC Accounts**
2. **Select Devices and releases for password generation**
3. **Passwords will be generated for the following devices**

1. Wizard Panel - Manage MTAC accounts

The Manage MTAC Accounts panel is used to add/modify/delete MTAC account information. Refer to Figure 5-44.

MTAC	Type	Status
6A9F88FC-C9E372C5-541851B2-33208844	AT-AR-RAPIER	18 of 25 available
64FD5790-2BEEDEDD-06EFE0B6-59631693	AT-AR-SB/9800 (SB)	48 of 50 available
E512DC7B-F4D67577-E169F80F-ECB0CDF8	AT-AR-SB/9800 (9800)	invalid password

MTAC: Password:

Type

AT-AR-7/400
 AT-AR750
 AT-AR440S and 450S
 AT-AR-RAPIER/8800
 AT-AR-SB/9800 (SB)
 AT-AR-SB/9800 (9800)
 AT-86/8700xl
 AT-AR-89/9900
 AT-9900s

FIGURE 5-44 MTAC Wizard - First Panel

The table displays the MTAC id, the MTAC type, and its current status. The MTAC id is provided by an ATI distributor or reseller. Before the NMS can use the MTAC, the customer has to log into the account with a web browser, create a password, and initialize the account (by entering the required contact information).

An MTAC can be one of 9 types, depending on the type of device for which it can be used to generate passwords:

1. AT-AR-7/400 for AT-AR700 series devices
2. AT-AR-RAPIER/8800 for Rapier devices
3. AT-86/8700x1 for 8600 and 8700 series devices
4. AT-AR750
5. AT-AR-SB/9800 (SB) for Switchblade devices
6. AT-AR-89/9900 for AT-8900 series devices
7. AT-AR440S and 450S
8. AT-AR-SB/9800 (9800) for 9800 series devices
9. AT-9900s for AT-9900 series devices

The current status of the MTAC indicates whether or not it can be used to generate passwords and if so, for how many passwords it can be used. Possible status values are in [Table 5-11](#).

TABLE 5-11 Possible Status Values for MTAC Accounts

Status	Meaning
unreachable	The WebGen server is currently unreachable.
invalid	Either the MTAC is invalid (entered incorrectly) or, if the server is reachable, the WebGen service itself is not currently in service
invalid password	The MTAC is correct, but the password is wrong (either entered incorrectly or changed)
x of y available	x passwords out of a total of y passwords are available for generation. That is, the MTAC was created with an initial capacity of y passwords and x are still available for use.
depleted	No passwords are left for generation. Equivalent to “0 of y available”
unavailable	The WebGen server is reachable but the account is nonfunctional for unknown reasons (for distributed server configuration)
uninitialized	The account exists but is not ready for use (for distributed server configuration)

The status will be filled in when the wizard is initialized, when MTACs are added or modified, and after passwords are generated. Retrieving the status can be slow since it has to go to the WebGen server. During this time, the buttons in this panel will be disabled and this popup dialog will show the status of the retrieval on an MTAC-by-MTAC basis

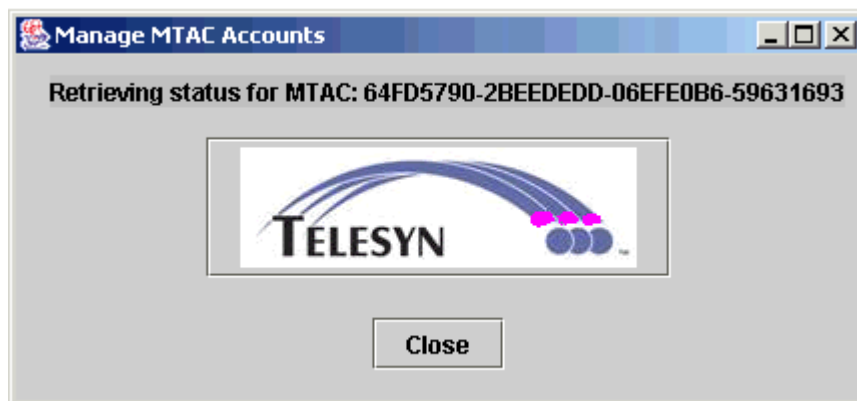

When a row of the table is selected with the cursor, the modifiable details of the selected MTAC are displayed in the fields below the table. Changes are committed with the Modify button. If an MTAC id is changed, the previous id will be deleted and replaced with the new id

New MTACs can be added with the Add button. MTACs with duplicate ids cannot be added. All fields (MTAC, Password, and Type) are mandatory. A new MTAC can be added by modifying an existing MTAC. As opposed to the Modify button, the Add button will keep the previous id and add the new id.

It is important that the correct Type is entered by the customer. In most cases, using the wrong Type will prevent password generation with no obvious errors other than a message at the end of the last wizard panel indicating either no passwords were generated or less were generated than attempted.

Note: In the case of Switchblade and 9800 series devices, either type can be used, but ATI's license fee structure allows Switchblade passwords to be generated at a discount, so the customer should be sure to use the correct Type or face unexpected fees. Any further validation of Type by the AlliedView NMS software is not possible.

The **Delete** button will delete all selected rows. Performance will be improved if all depleted and invalid MTACs are removed as soon as possible so their status won't be re-retrieved.

MTAC information is stored on the server in the file `<NMSHome>/swdownload/MtacFile`.

The **Next** button performs no processing other than bring up the second wizard panel.

Note: If all MTAC information is up to date, the 1st panel is actually for confirmation only and can be skipped.

The **Cancel** button will close the wizard without generating passwords but will save any modifications made to MTAC account information

Some of the possible error dialogs that can popup from this wizard panel are included in [Figure 5-45](#)

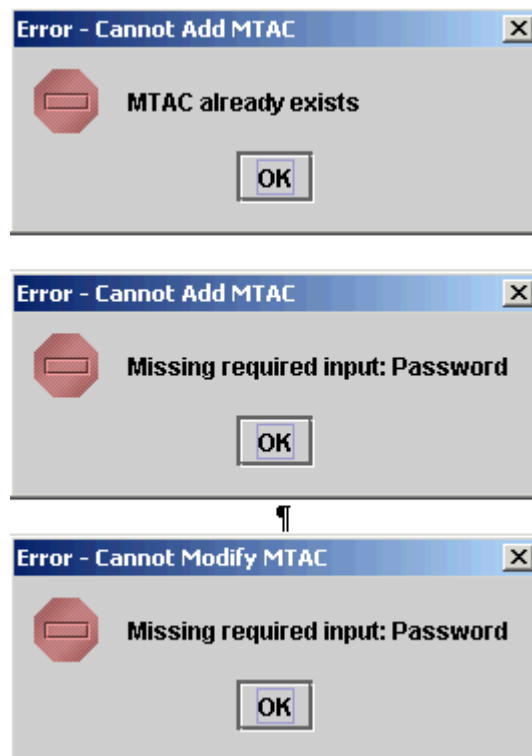

FIGURE 5-45 Possible Error Messages for MTAC Wizard Panel (1)

2. Second Wizard Panel - Select devices and releases for password generation

The second panel displays all the devices, their serial numbers, their supported releases, and their passwords, if any. Refer to [Figure 5-46](#).

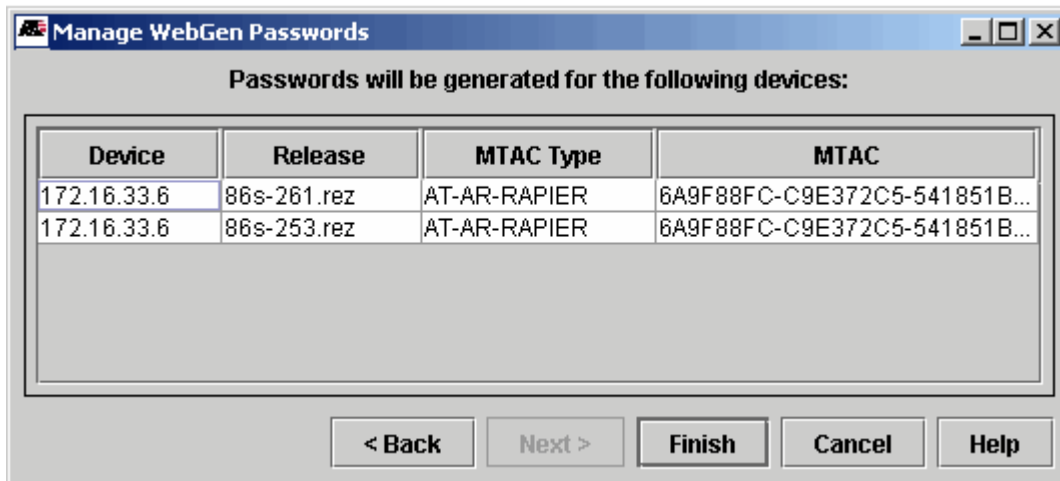

FIGURE 5-46 MTAC Wizard - Second Panel

Devices and releases can be selected from the table for password generation. Although any or all rows from the table can be selected, the ones that already have passwords will be ignored during password generation.

The **Back** button returns to the MTAC panel.

The **Next** button prepares the selected devices/releases for password generation, checks to make sure there are enough MTACs with available passwords for generation, and if all is well, brings up the third panel for confirmation.

Some of the error/warning messages possible from this panel include the following in [Figure 5-47](#).

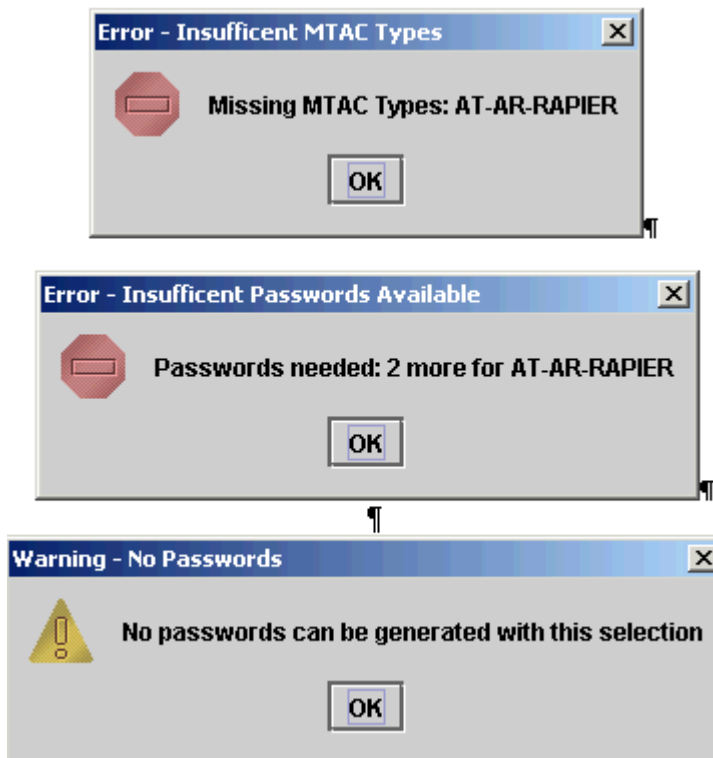

FIGURE 5-47 Possible Error Messages for MTAC Wizard Panel (2)

3. Third Wizard Panel - Passwords will be generated for the following devices

The 3rd panel provides the user a chance to confirm selections before committing them, as shown in [Figure 5-48](#).

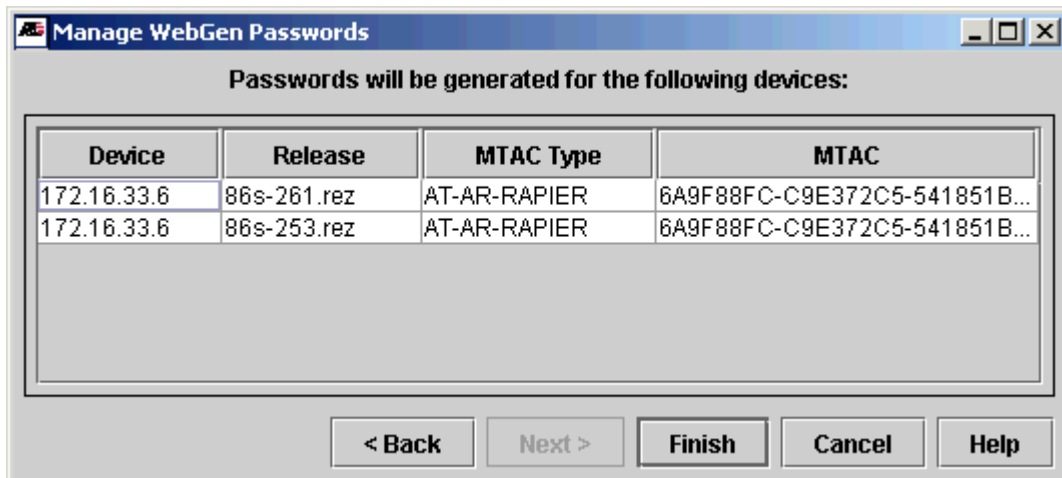

FIGURE 5-48 MTAC Window - Third Panel

For each password to be generated, this panel displays the device, the release, the MTAC type, and the MTAC that will be used.

There are no row operations on this panel.

The **Back** button returns to the previous panel and can be used to change the device/release selection. The **Finish** button initiates the password generation process. This process can be slow since it has to go to the WebGen server. During this time a popup status display will show progress on an MTAC-by-MTAC basis.

If all passwords are successfully generated, a popup display will indicate so. Upon acknowledging this popup, the wizard will be dismissed. If any errors are detected during password generation, a popup message will indicate so and the wizard will remain up for modifications.

An example of the success popup dialog is [Figure 5-49](#).

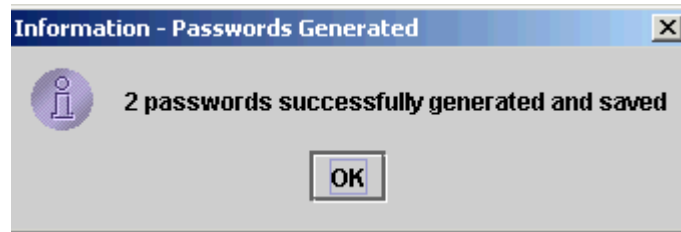

FIGURE 5-49 Example of using the MTAC Wizard Successfully

Note: When running the AlliedView NMS client as an applet or a Web Start client, by default, the client will not have permission to open a network connection to the WebGen server. Attempts to access the WebGen server will result in the following error:

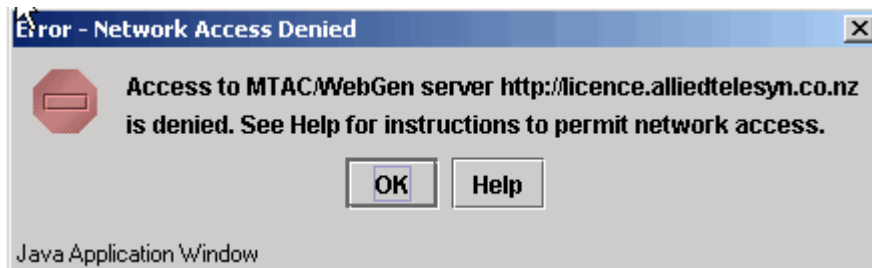

FIGURE 5-50 Access Control Exception Error

To give the client the necessary permission, it will be necessary to add the following permission statement to the Java security policy file on the client's host:

```
grant {
    permission java.net.SocketPermission "licence.alliedtelesyn.co.nz", "connect,resolve";
};
```

This statement grants Java applets permission to resolve the host name and open connections to the server (licence.alliedtelesyn.co.nz). The client will have to be terminated and restarted before the permission change will take effect. This permission is only needed for WebGen, so, if desired, the permission may be removed after finishing WebGen operations.

The location of the Java security policy file depends on where the Java runtime and/or the Web Start application were installed on the host. Refer to the following table:

OS	Applet/Client	Path
Windows	Java Applet	<Java Home>\lib\security\java.policy
	Web Start Client	<Web Start Home>\javaws.policy
Solaris	Java Applet	<Java Home>/lib/security/java.policy
	Web Start Client	<Web Start Home>/javaws.policy

<Java Home> is the directory where the Java runtime was installed. On Windows, this is usually C:\Program Files\j2re1.4.1_01.

<Web Start Home> is the directory where the Web Start application was installed. On Windows, this is usually C:\Program Files\Java Web Start

5.3.10 Software Configuration (Custom Loads)

The Custom load configuration is entered from the Software Configuration application using the **Create Custom Load** button, as shown in [Figure 5-40](#), at the beginning of this subsection on Software Configuration. This button is device independent and therefore enabled with or without any devices selected.

Selecting the **Create Custom Loads** button brings up the **The Custom Device Loads** Form, as shown in [Figure 5-51](#). This shows all the device loads. Load names and types are listed in a table, which can be sorted by clicking on a column heading. Double clicking a column heading puts the table back in its unsorted order, which is usually with the newest loads at the bottom.

Loads are groups of device configurations that can be selected when downloading software releases to devices. Loads types are:

- **Standard** - The standard loads are pre configured in the NMS release and can be viewed in detail but neither modified nor deleted.
- **Custom** - Custom loads are created by users and can be added, modified, viewed, and deleted, which are the tasks that make up this feature.

The **Modify** button allows modifying a description. Select a custom load from the table, modify the description, and then press the **Modify** button. (Names cannot be modified after creation)

The **Delete** button allows deleting a load. Select a custom load from the table and press **Delete**. If the load contains any detailed data, the user will be prompted to confirm the deletion.

The **Details** button brings up the **Load Details** form for the selected load. Select a load from the table, either standard or custom, and press **Details**. Details can also be brought up by double-clicking a row. Refer to [Figure 5-52](#).

The **Close** button closes the dialog and saves all the changes. If for any reason communication is lost to the NMS server, the user will be prompted to confirm closing (and lose any changes) or cancel closing. The message is:

Cannot Save Custom Load File. Do you want to continue exiting (and possibly lose any changes?)

After resolving the communications problem, the dialog can be closed and the data will be saved.

Load Name	Load Type
Latest NMS Compatible Loads	Standard
Latest NMS-supported RG/IMG Loads	Standard
ADSL IMG/RG Release 3.3.X	Standard
Fiber IMG/RG Release 2.3.X	Standard
Rapier/SwitchBlade 2.7.X Base Release	Standard
Rapier/SwitchBlade 2.6.X	Standard
Rapier Release 2.5.X	Standard
Telesyn iMAP Release 8.0	Standard
Telesyn iMAP Release 7.0	Standard
Telesyn iMAP Release 6.1	Standard
Telesyn iMAP Release 6.0	Standard
Telesyn iMAP Release 8.0 (Annex-B)	Standard
Telesyn iMAP Release 7.0 (Annex-B)	Standard
Telesyn iMAP Release 6.1 (Annex B)	Standard
Telesyn iMAP Release 6.0 (Annex-B)	Standard
ADSL IMG/RG Release 3.2.X	Standard

Load

Name: Latest NMS Compatible Loads

Description: This will load the latest loads supported by the NMS for the types of devices selected.
 For AR410 devices: Maint Release=2.7.1-03
 For AR440S devices: Maint Release=2.7.5-02
 For AR720/740: Release=2.6.4 Patch=3
 For AR725/745: Base Release=2.7.5
 For AR750 devices: Release=2.7.5 Patch=NONE
 For 8600 devices: Base Release=2.7.5
 For 8700 devices: Maint Release=2.7.5-02
 For 8800 devices: Maint Release=2.7.5-02
 For 8900 devices: Maint Release=2.7.5-02
 For 9800 devices: Maint Release=2.7.5-02
 For 9900 devices: Release=2.7.5 Patch=NONE
 For 9900s devices: Release=3.0.2 Patch=NONE
 For Rapier devices: Release=2.6.4 Patch=8
 For Rapier (I) devices: Maint Release=2.7.5-02
 For Rapier (G) devices: Maint Release=2.7.3-07
 For SwitchBlade devices: Maint Release=2.7.4-02
 For Telesyn iMAP devices: RELEASE=8.0.0 (assumes Annex A for ADSL24 cards)

Add Modify Delete Details Help

Close

FIGURE 5-51 Custom Device Loads Form

When the **Details** button is selected, the form is brought up, it shows the name and description of the selected load, all the types belonging to the load, and all the details for any selected type from the table. If the load is a standard load, none of the fields are modifiable. The details consist of a table of File Keys and File Names. The keys are the different types of files required to load a release and the names are the files for the particular release. In some cases, certain file types are optional and NONE will be used for the key. Refer to [Figure 5-52](#).

Load

Name: Latest NMS Compatible Loads

Description: For Rapier devices: Release=2.6.4 Patch=8
 For Rapier (I) devices: Maint Release=2.7.5-02
 For Rapier (G) devices: Maint Release=2.7.3-07
 For SwitchBlade devices: Maint Release=2.7.4-02
 For Telesyn iMAP devices: RELEASE=8.0.0 (assumes Annex A for ADSL24 c

Device Type	Device Category
AT-6624POE	Rapier
AT-9924Ts	Rapier
7400	Telesyn
7700	Telesyn
9100	Telesyn
9101	Telesyn
9102	Telesyn
9103	Telesyn
9400	Telesyn
9700	Telesyn
9400-56	Telesyn
9700-56	Telesyn

Load details

9400-56

File Key	File Name	
NEW_ADSSL16B_LOAD	adsl16b_8.0.0.tar	Browse
NEW_ADSSL16C_LOAD	adsl16c_8.0.0.tar	Browse
NEW_ADSSL16_LOAD	adsl16_8.0.0.tar	Browse
NEW_ADSSL24A_LOAD	adsl24a_8.0.0.tar	Browse
NEW_ADSSL24B_LOAD	adsl24b_8.0.0.tar	Browse
NEW_ADSSL24_LOAD	adsl24_8.0.0.tar	Browse
NEW_ADSSL8_LOAD	adsl8_8.0.0.tar	Browse

Add Modify Delete Help Close

FIGURE 5-52 Custom Device Loads Form - Standard Load

If the load is a custom load, then types can be added, modified, and deleted. See [Figure 5-53](#).

Load

Name: Load 725 - Release 2.5.3

Description: Install release 2.5.3 on AT-AR700 series devices.

Device Type	Device Category
AT-AR725	Rapier
AT-AR720	Rapier
AT-AR740	Rapier
AT-AR745	Rapier

Type Details

AT-AR725

File Key	File Name	
NEW_GUI_RESOURCE	d_725e03.rsc	Browse
NEW_HELP	700-253a.hlp	Browse
NEW_PATCH	52253-02.paz	Browse
NEW_RELEASE	52-253.rez	Browse

Add Modify Delete Help Close

FIGURE 5-53 Custom Device Loads Form - Custom Load

To add a new type, begin by choosing the type from the combo box in **Type Details**, as shown in [Figure 5-54](#). The file keys for the type are predefined and will appear in the File Keys column. The File Names will normally be blank, but in some cases where a file name was listed for the same key from the previous type, if any, the name will default to the previous name. (In some cases the same file names are usable for the same keys in different types, but in general, different device types have different keys)

If the type selected from the combo box already exists in the load, its row in the table above will be highlighted and its details will be defaulted to their existing values.

Push the **Add** button after entering all the details and verify the new type is added to the table. If you do anything else instead of pushing the Add button, a popup dialog will ask whether or not to finish the addition for the device.

The **Modify** button allows modifying the details of a type. Select the type either via the table or the combo box, modify the file names, and then push Modify. If you do anything else instead of pushing the Modify button, a popup dialog will ask whether or not to finish the modification.

The **Delete** button allows deleting a type from the load. Select the type to delete using either the combo box or the table, then push **Delete**.

More than one Details dialog can be displayed at the same time so Load contents can be compared and values can be copied and pasted from one load to another (using `ctrl-c` and `ctrl-v`).

Note: Displaying details and modifying the same load in more than one simultaneous dialog, however, is not recommended. The changes to the load will occur as they're made, but all the dialogs will not be refreshed as they occur.

Device Type	Device Category
AT-AR725	Rapier
AT-AR720	Rapier
AT-AR740	Rapier
AT-AR745	Rapier

FIGURE 5-54 Load Details Form - Selecting a New Type

The file name can be typed, pasted (with `ctl-v`), or selected with a file chooser. The file chooser will list all the files loaded in the device's category directory (either `swdownload/Rapier` or `swdownload/MAP`). See [Figure 5-55](#).

In some cases, one or more file names will be optional for a load. When unneeded for iMAP devices, the field should be left blank. For Rapier devices, the field should be set to NONE. Otherwise, errors may be returned during Software Configuration.

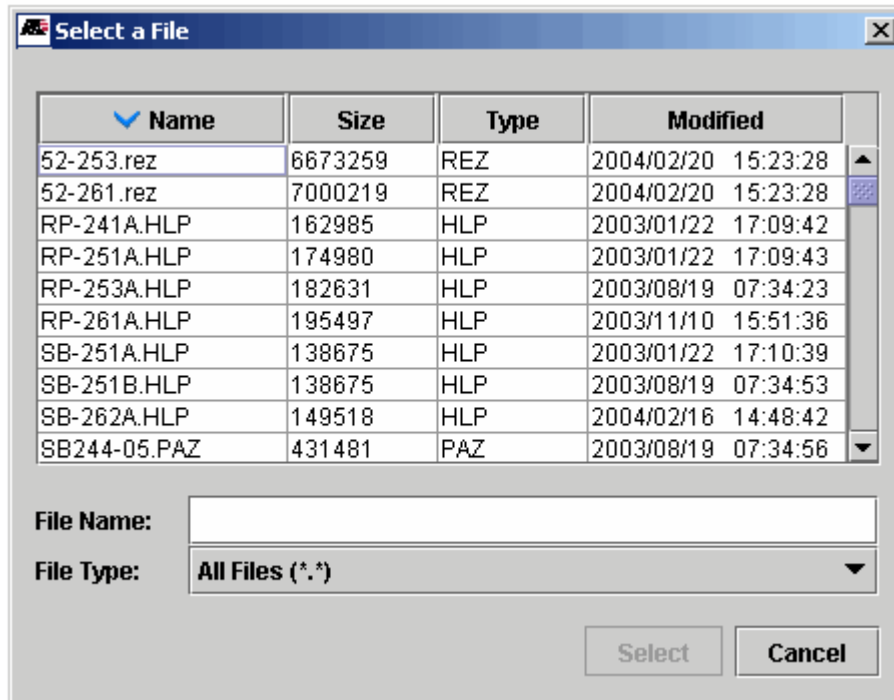

FIGURE 5-55 File Chooser - to select a file in Type Details

After creation, custom loads can be selected when modifying a device software configuration. A warning will be displayed the first time a custom load is used giving the user a last chance to back out before making sure the load configuration is defined correctly. See [Figure 5-56](#).

Note: Once a custom load is used, the warning will never be displayed again.

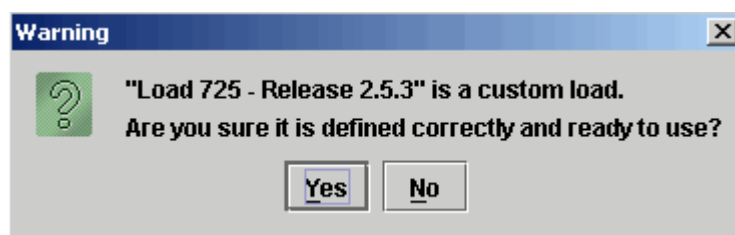

FIGURE 5-56 Confirmation Before Using a Custom Load

5.3.10.1 Creating a Custom Load for the SBx3112

For the SBx3112 load release 16.0.x, there is a common line card load that includes the text string sma (currently x31sma_16.0.1.tar). If you try to use the Software Configuration feature and select the standard SBx3112 load, you will receive a 'Card not Supported' error. Refer to the following figure.

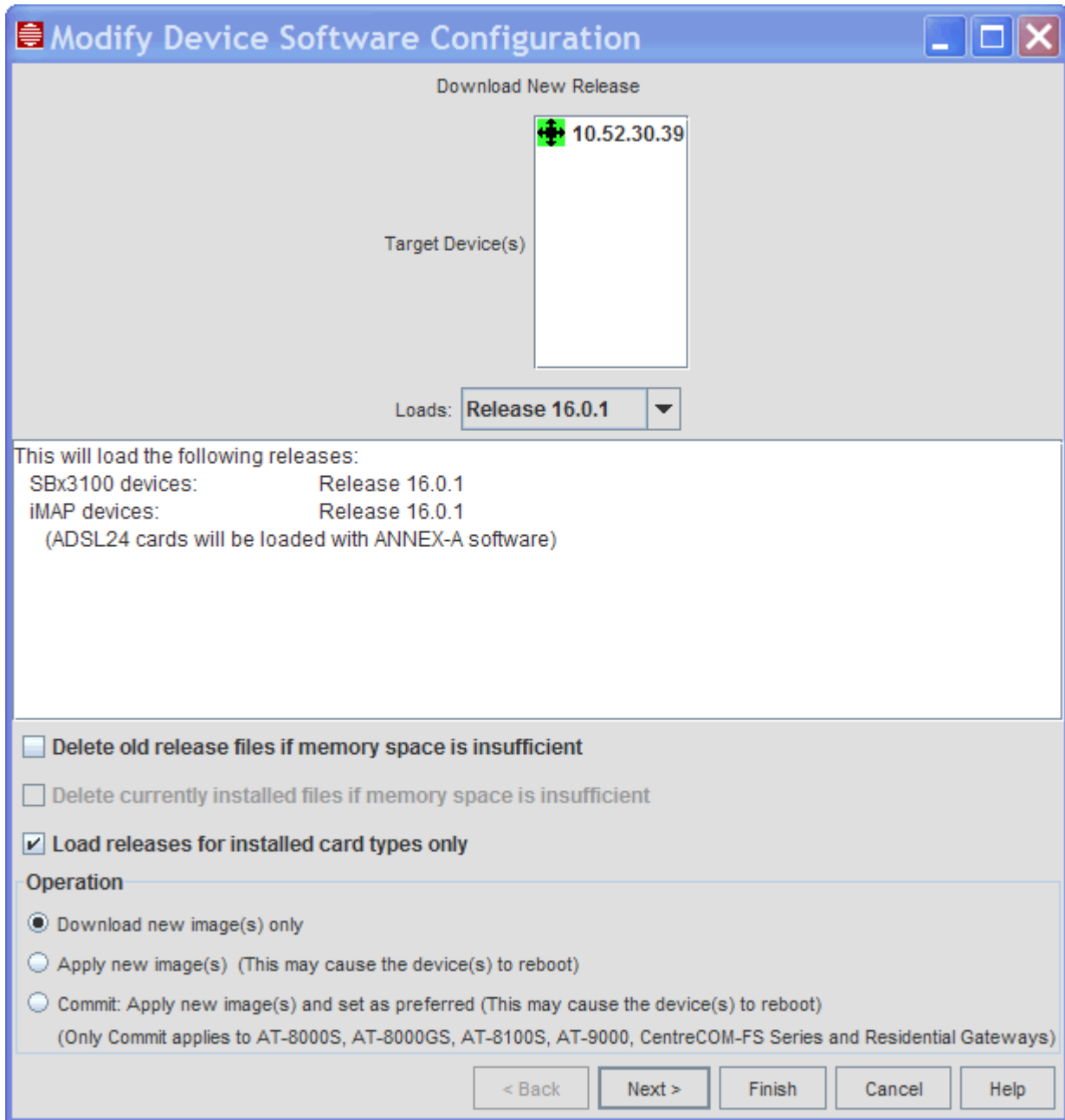

FIGURE 5-57 Download Standard iMAP/SBx3112 - Will fail for SBx3112.

To download a correct SBx3112 load, you must build a custom load that includes this same sma-type file for **all** of the line cards. Following is an example.

In the Load window, enter (or type over) the name and Description for the Load. Refer to the following figure.

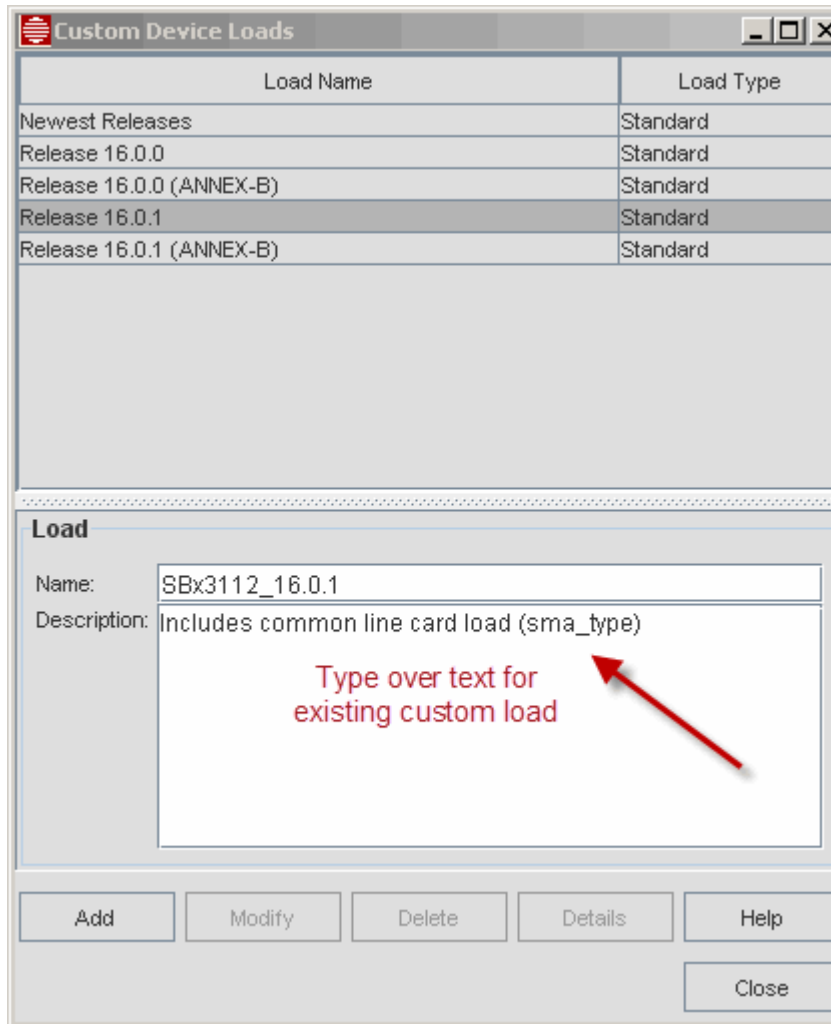

FIGURE 5-58 Creating Custom Load Name

Then press the **Add** button. The Name is added to the Load Name list in the upper panel.

Possible error messages are:

- A Description is Required
- Load <New Load> Already Exists

Pushing the **Details** button brings up the Load Details window.

Under Load details, select the SBx3112 from the pull-down. Refer to the following figure.

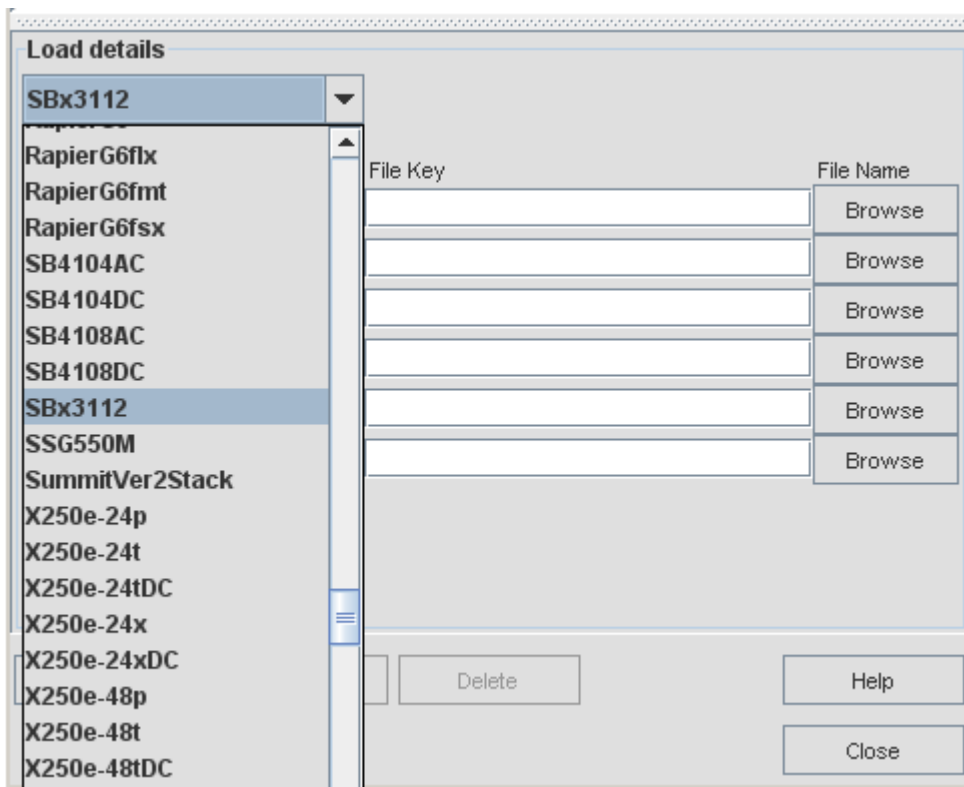

FIGURE 5-59 Selecting Device for Load Details

The Load details panel lists the types of loads for the device. For the CFC200, select Browse and choose the appropriate cfc200 file. For the line cards, select the same sma-type file for all. Refer to the following figure.

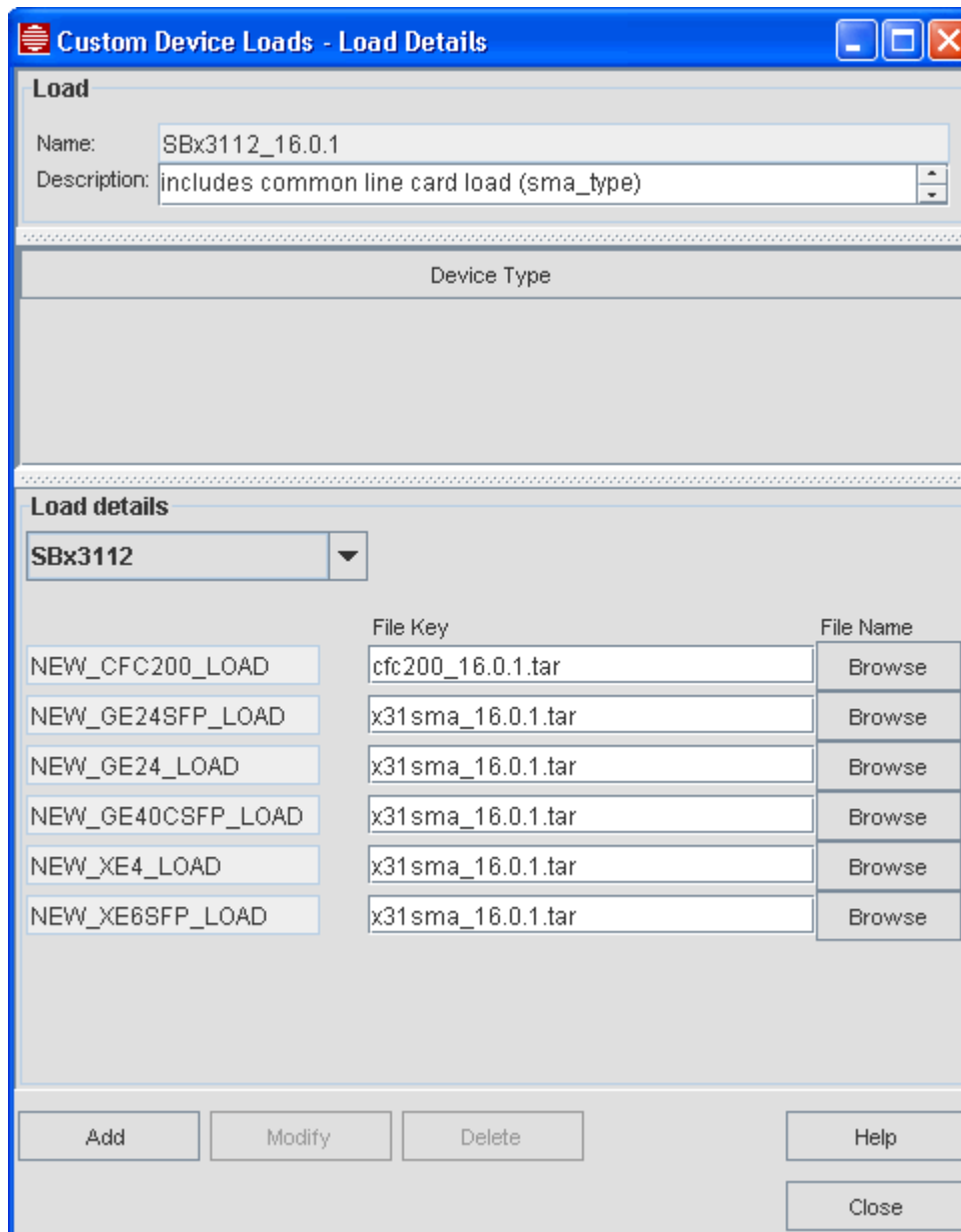

FIGURE 5-60 Adding Line Card Loads for SBx3112 (same file)

Click on **Add**. Then click **Modify** on the Load panel. This custom load is now added, and will appear as a possible load for the Modify Release Configuration, as described in [5.3.10](#)

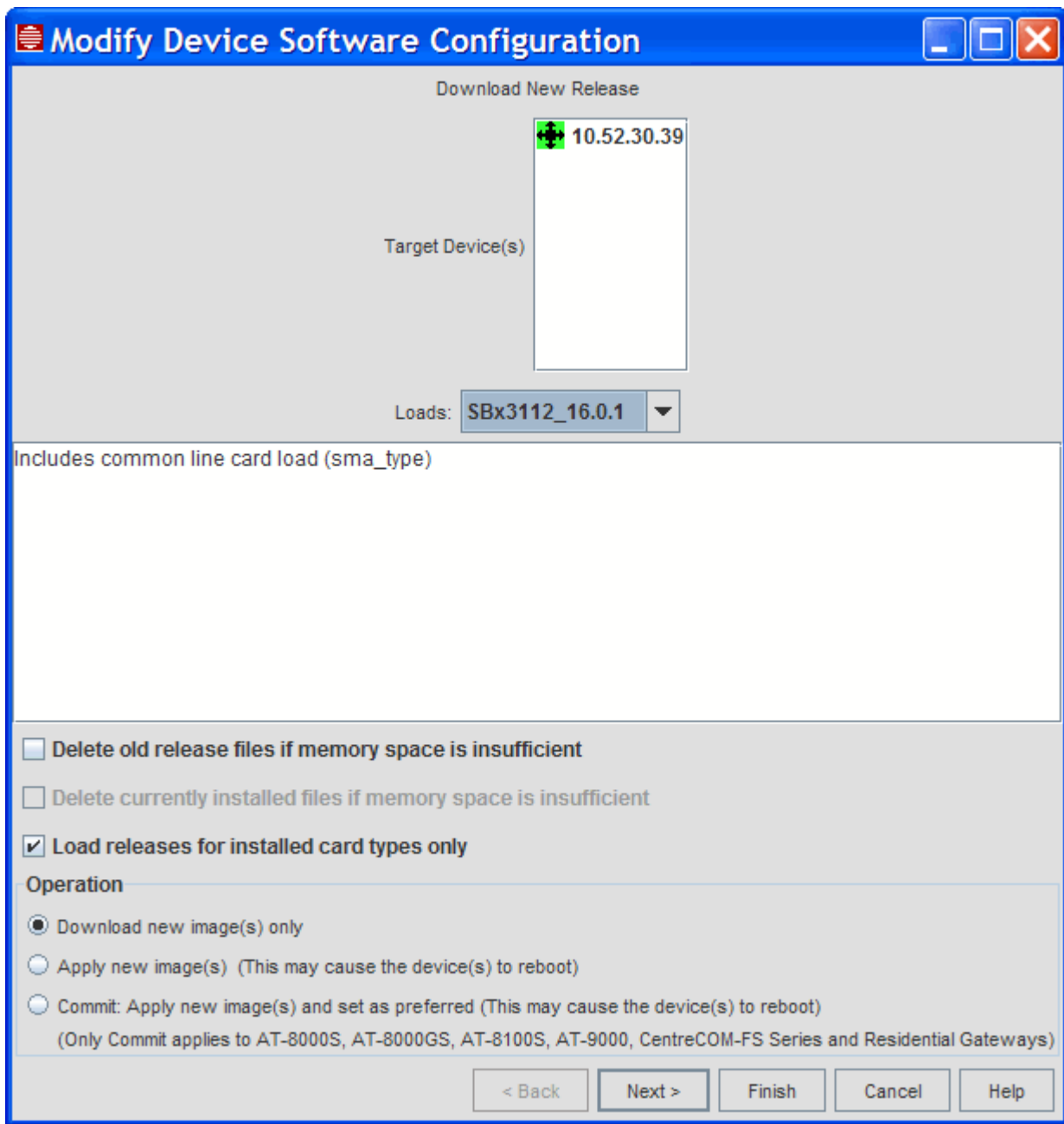

FIGURE 5-61 Custom Load for SBx3112 for Software Device

Note: Another option is to use the Card Management feature to load each card individually with the sma line card load.

5.3.11 Using Custom Loads to Reduce Unneeded Card Types

Standard loads are defined to load software for all card types a device may support at a given release level. In most cases, this will be more software than necessary since most devices will not contain all possible card types. Download times and memory usage will be greater than necessary. To streamline software configuration, create a **Custom Load** containing only the necessary files. Leave the fields for the unneeded files blank. You can use the **Details** display of a standard load as a guide to see the names of the files you do need.

Figure 5-62 shows a **Load Details** window for a Standard Load that can be used as a guide for creating a streamlined Custom Load. Filenames can be copied/pasted from this display to the custom load display (Use **ctl-c/ctl-v** on Windows, left-click/middle-click on Solaris)



FIGURE 5-62 Details Display for Standard Load (Used to Create Custom Load of Only Certain Files)

Figure 5-63 shows a Custom Device Loads window in which a custom load has been built that supports only the ADSL24A, CFC6, and POTS24 card types on a 7400.

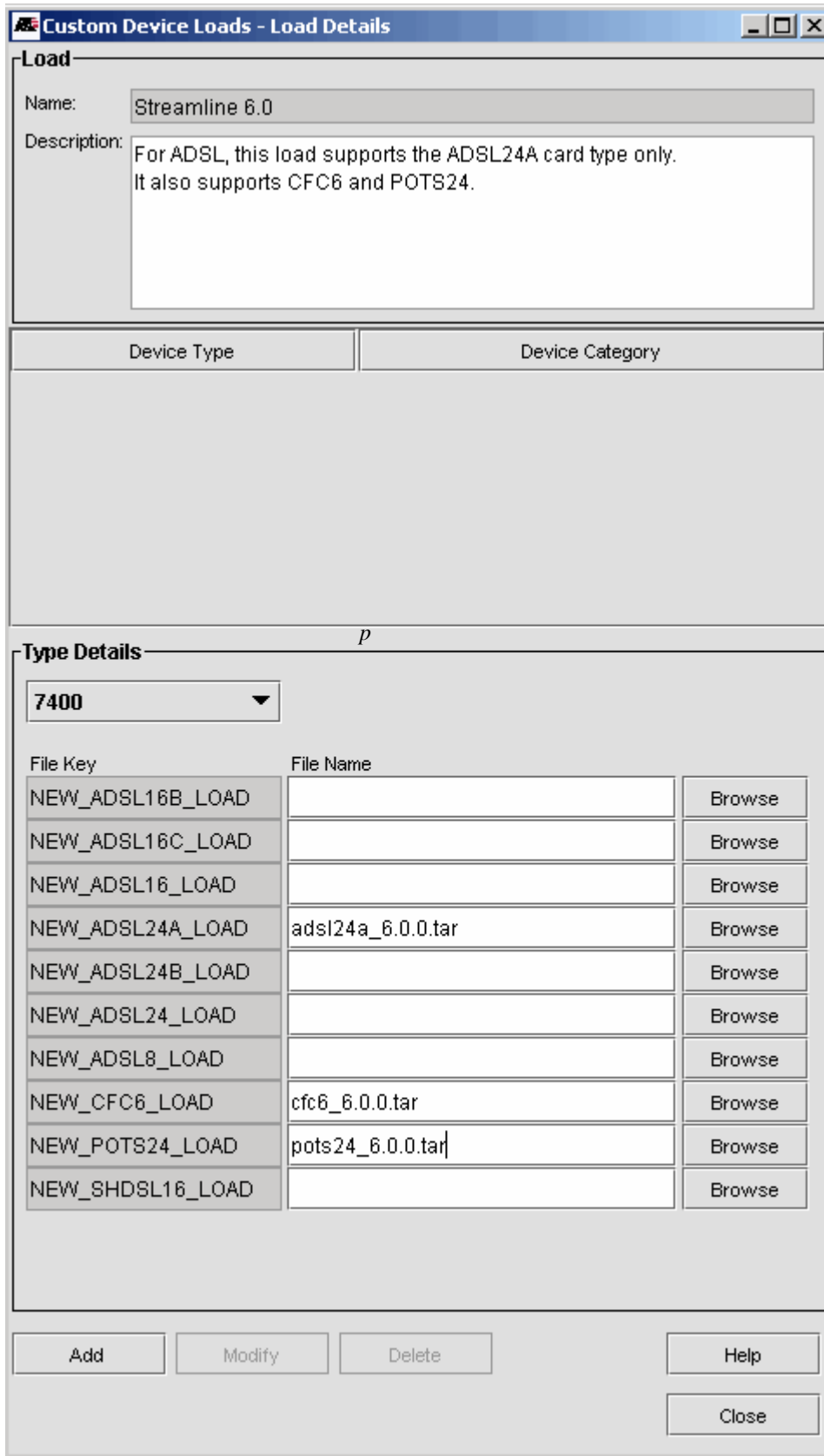

FIGURE 5-63 Custom Load Containing Only Necessary Files

5.3.12 SysLog Management

The SysLog Management application allows you to manage logs from the managed devices in the AlliedView NMS. When the *SysLog Management* application is chosen and the **Collect Data** icon is clicked, the following figure appears.

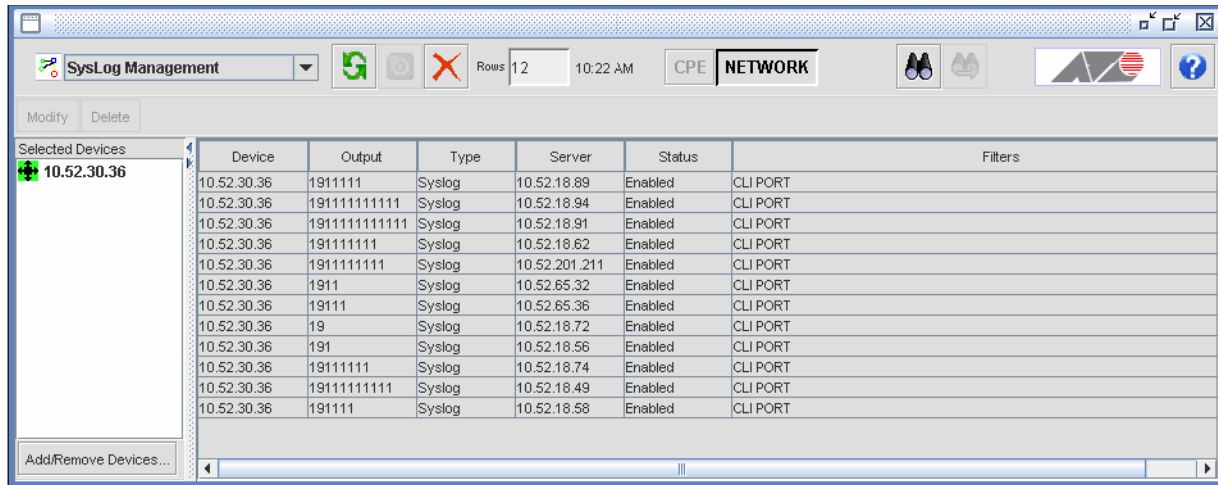

FIGURE 5-64 SysLog Management Panel

From this panel, you can delete selected rows by pressing the **Delete** button. A confirmation window confirms the deletion. From this panel, you can modify the system log properties of each device by selecting the device and then clicking **Modify**. When you click **Modify**, the following window appears.

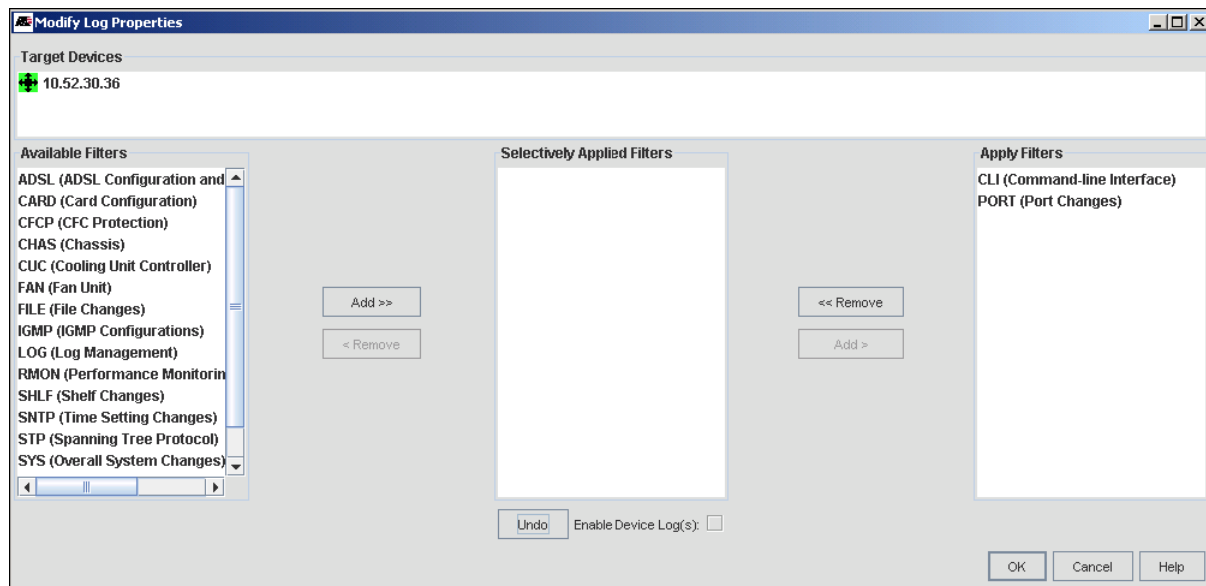

FIGURE 5-65 SysLog Management Application Modify Log Properties Window - File

This window allows you to apply or remove system log filters to or from each device. The **Available Filters** list box lists the log filters that may be applied to the selected devices. The **Selectively Applied Filters** list box lists filters that are applied to some of the selected devices, but not all. The **Apply Filters** list box lists the filters that are applied to all of the selected devices.

For information on configuring the AlliedView NMS system logs, refer to [9.6](#).

5.3.13 LLDP Protocol and Associated Features (LAG/VCS Monitoring)

The LLDP protocol feature on devices is a way to advertise data that is useful for discovering information about a network link port. If the administrator manually enables LLDP for each device and sets the direction as BOTH, the links between the devices will appear on the physical map GUI as the devices are (re)discovered.

Note: For a complete description of LLDP and its parameters, refer to the iMAP Software Reference Manual.

The administrator can activate and control LLDP for one or multiple devices using an application. Moreover, one minute after LLDP has been activated (with a direction of BOTH), the device will be re-discovered and the links will appear on the physical map based on the LLDP data.

Caution: It is not recommended to include a HUB switch when using the LAG/VCS monitoring feature or any feature that uses the LLDP application. A HUB switch provides a one-to-many configuration for data traffic, so all LLDP information is propagated to multiple devices. As a result, the devices will build an incorrect set of connection information. Moreover, the topology displayed will not be correct, and can even look like a loop.

Like other applications, the administrator can select one or more devices, right click, and then choose **Provision -> LLDP Configuration**, and then bring up the application, as shown in the following figure.

*Note: You can also select **Tools -> Application Manager**, select **LLDP Configuration** in the pull-down menu, and add devices.*

Device	Device Attrs.	TX Only	RX Only	TX + RX	No LLDP	Notify On	Options
10.52.30.34	30, 4, 2, 2, 5	None	None	4.0-4.2	4.3-4.7,10.0,11.0...	4.0-4.2	VLANNNAME:ALL LINKAGGREGATION:ALL PORTVLAN:ALL UCP:ALL PROT...
10.52.30.36	30, 4, 2, 2, 5	None	None	None	1.2,4.0,4.1,5.0	None	VLANNNAME:4.0,5.0 LINKAGGREGATION:4.0,5.0 PORTVLAN:4.0,5.0 UCP:4...
10.52.30.37	30, 4, 3, 3, 6	None	None	1.0,4.0,4.1	4.3,4.4,4.6,4.7	1.0,4.0,4.1,4.4,4...	VLANNNAME:1.0,4.0,4.1,4.4,4.6,4.7 LINKAGGREGATION:1.0,4.0,4.1,4.4,4.6,4...
10.52.30.38	30, 4, 2, 2, 5	None	None	1.0-1.2	9.0-9.3,9.5-9.7	1.0-1.2	VLANNNAME:ALL LINKAGGREGATION:ALL PORTVLAN:ALL UCP:ALL PROT...
10.52.32.2	30, 4, 2, 3, 5	None	None	1.0.1,1.0.2,1.0.3...	None	1.0.1,1.0.2,1.0.3...	MANAGEMENTADDRESS:ALL VLANNNAME:ALL LINKAGGREGATION:ALL P...

FIGURE 5-66 LLDP Application for iMAP Devices

The application shows for each device the following:

- Device Attrs. - These are listed and allowed to be changed in the first **LLDP MultiDevice Wizard** panel.
- Direction - This can be TX, RX or both.
- No LLDP - Whether LLDP is active or not on the port. (This is controlled by the Notify option.)

Options - There are multiple options, and these are controlled by the second **LLDP MultiDevice Wizard** panel.

The administrator can choose one or multiple devices with which to activate and control LLDP, as explained below.

5.3.13.1 LLDP for Multiple Devices

Note: In most cases, the administrator should first choose all the relevant devices that will have LLDP activated and set the attributes for all devices. The administrator could then if desired choose a device and change specific attributes. Otherwise, if settings are applied to a specific device, and changes are then made for multiple devices that affect those settings, any changes to that specific device would be overwritten.

When more than one device is chosen and the **Configure LLDP** Button is selected, the **LLDP MultiDevice Wizard** panel appears. The following figure shows the first panel when multiple devices are selected.

Attribute	Current Values	New Value
Transmit Interval (secs):	5	<input type="text"/> [5-32768]
Transmit Hold Multiplier:	4	<input type="text"/> [2-10]
Transmit Delay (secs):	1	<input type="text"/> [1-8192]
Reinitialization Delay (secs):	Mixed	<input type="text"/> [1-10]
Notification Interval (secs):	5	<input type="text"/> [5-3600]

FIGURE 5-67 LLDP MultiDevice Wizard for Multiple iMAP Devices - First Panel

Note the Re initialization Delay attribute has *Mixed* rather than a numeric value. This means there are different values of the devices. Inputting a New Value (such as 2) will change the value to 2 for **all** the selected devices.

The second panel brings up a panel that controls the options for the multiple devices. The following figure shows an example where LLDP is set to All OFF.

LLDP MultiDevice Wizard

Configure LLDP on Devices

Options are applied to All LLDP TX and TX+RX ports on All Devices

Attribute	Current Value	New Value
LLDP Mode:	All TX Only	<input type="text"/> ▼
LLDP Notification:	All ON	<input type="text"/> ▼

Apply Actions to All Network Ports on All Devices

Option	Current Value	Tx Ports Action
ALL	All ports on all devices	<input type="checkbox"/> No Change
PORTDESC	All ports on all Devices	<input type="checkbox"/> No Change
SYSNAME	All ports on all Devices	<input type="checkbox"/> No Change
SYSDISC	All ports on all Devices	<input type="checkbox"/> No Change
SYSCAP	All ports on all Devices	<input type="checkbox"/> No Change
MACPHYCONFIGSTATUS	All ports on all Devices	<input type="checkbox"/> No Change
POWERVIAMDI	All ports on all Devices	<input type="checkbox"/> No Change
LINKAGGREGATION	All ports on all Devices	<input type="checkbox"/> No Change
MAXFRAMESIZE	All ports on all Devices	<input type="checkbox"/> No Change
PORTVLAN	All ports on all Devices	<input type="checkbox"/> No Change
VLANNAME	All ports on all Devices	<input type="checkbox"/> No Change
PROTOVLAN	All ports on all Devices	<input type="checkbox"/> No Change
PROTOCOL	All ports on all Devices	<input type="checkbox"/> No Change
EPSR	All ports on all Devices	<input type="checkbox"/> No Change
UCP	All ports on all Devices	<input type="checkbox"/> No Change

< Back Next > Finish Cancel Help

FIGURE 5-68 LLDP MultiDevice Wizard for Multiple iMAP Devices - Second Panel

The pull-downs are as follows:

- LLDP Mode - The options are TX, RX, BOTH or OFF. Note that **to activate LLDP so that the links are drawn on the physical map, this must be set to BOTH**. The specific attributes for the ports can then be set.
- LLDP Notification - This can be set to ON or OFF.

For the options, the Current Value shows how the option is currently being applied. The user has the following actions to choose from:

- ALL Row
 - Add to All - make all options apply to all ports if the option is not applied to any or some ports

- Delete from All - delete all options from all ports if the option is applied to any or some ports.
- Other options
 - Add to All - make the one option apply to all ports. This would take priority over the ALL Row.
 - Delete from All - make the one option be deleted for all ports. This would take priority over the ALL Row.
 - No Change - Keep the current value regardless of any changes made with the ALL option. This would only apply if the current value was not All ports on All devices.

The user can then select **Finish** to bring up the Task Details window or **Next** to bring up the Task Schedule window.

5.3.13.2 LLDP for One Device

When the **Configure LLDP** button is activated, and when pressed the first **LLDP MultiDevice Wizard** panel appears, as shown in the following figure.

Attribute	Current Values	New Value
Apply to All Devices <input checked="" type="checkbox"/>		
Transmit Interval (secs):	5	<input type="text"/> [5-32768]
Transmit Hold Multiplier:	4	<input type="text"/> [2-10]
Transmit Delay (secs):	1	<input type="text"/> [1-8192]
Reinitialization Delay (secs):	2	<input type="text"/> [1-10]
Notification Interval (secs):	5	<input type="text"/> [5-3600]

< Back Next > Finish Cancel Help

FIGURE 5-69 LLDP MultiDevice Wizard for One iMAP Device - First Panel

The current values for the selected device is shown, and the user can change the values within the range shown. Selecting the **Finish** button brings up the Task Window to show the progress of the changes taking effect. Selecting the **Next** button brings up the Configure LLDP Options panel, as shown in the following figure.

Port	Mode	Notify	All Options	PORTDESC	SYSNAME	SYSDESC	SYSCAP	MACPHYCONFIGSTATUS	POWERVERIAMDI
ALL Ports		<input type="checkbox"/>	<input type="checkbox"/>	<input type="checkbox"/>	<input type="checkbox"/>	<input type="checkbox"/>	<input type="checkbox"/>	<input type="checkbox"/>	<input type="checkbox"/>
0.0	BOTH	<input checked="" type="checkbox"/>	<input type="checkbox"/>	<input checked="" type="checkbox"/>	<input checked="" type="checkbox"/>	<input checked="" type="checkbox"/>	<input checked="" type="checkbox"/>	<input checked="" type="checkbox"/>	<input checked="" type="checkbox"/>
0.1	BOTH	<input checked="" type="checkbox"/>	<input type="checkbox"/>	<input checked="" type="checkbox"/>	<input checked="" type="checkbox"/>	<input checked="" type="checkbox"/>	<input checked="" type="checkbox"/>	<input checked="" type="checkbox"/>	<input checked="" type="checkbox"/>
0.2	BOTH	<input checked="" type="checkbox"/>	<input type="checkbox"/>	<input checked="" type="checkbox"/>	<input checked="" type="checkbox"/>	<input checked="" type="checkbox"/>	<input checked="" type="checkbox"/>	<input checked="" type="checkbox"/>	<input checked="" type="checkbox"/>
1.0	BOTH	<input checked="" type="checkbox"/>	<input type="checkbox"/>	<input checked="" type="checkbox"/>	<input checked="" type="checkbox"/>	<input checked="" type="checkbox"/>	<input checked="" type="checkbox"/>	<input checked="" type="checkbox"/>	<input checked="" type="checkbox"/>
1.1	BOTH	<input checked="" type="checkbox"/>	<input type="checkbox"/>	<input checked="" type="checkbox"/>	<input checked="" type="checkbox"/>	<input checked="" type="checkbox"/>	<input checked="" type="checkbox"/>	<input checked="" type="checkbox"/>	<input checked="" type="checkbox"/>
1.2	BOTH	<input checked="" type="checkbox"/>	<input type="checkbox"/>	<input checked="" type="checkbox"/>	<input checked="" type="checkbox"/>	<input checked="" type="checkbox"/>	<input checked="" type="checkbox"/>	<input checked="" type="checkbox"/>	<input checked="" type="checkbox"/>
6.0	BOTH	<input checked="" type="checkbox"/>	<input type="checkbox"/>	<input checked="" type="checkbox"/>	<input checked="" type="checkbox"/>	<input checked="" type="checkbox"/>	<input checked="" type="checkbox"/>	<input checked="" type="checkbox"/>	<input checked="" type="checkbox"/>
6.1	BOTH	<input checked="" type="checkbox"/>	<input type="checkbox"/>	<input checked="" type="checkbox"/>	<input checked="" type="checkbox"/>	<input checked="" type="checkbox"/>	<input checked="" type="checkbox"/>	<input checked="" type="checkbox"/>	<input checked="" type="checkbox"/>
6.2	BOTH	<input checked="" type="checkbox"/>	<input type="checkbox"/>	<input checked="" type="checkbox"/>	<input checked="" type="checkbox"/>	<input checked="" type="checkbox"/>	<input checked="" type="checkbox"/>	<input checked="" type="checkbox"/>	<input checked="" type="checkbox"/>
6.3	BOTH	<input checked="" type="checkbox"/>	<input type="checkbox"/>	<input checked="" type="checkbox"/>	<input checked="" type="checkbox"/>	<input checked="" type="checkbox"/>	<input checked="" type="checkbox"/>	<input checked="" type="checkbox"/>	<input checked="" type="checkbox"/>
6.4	BOTH	<input checked="" type="checkbox"/>	<input type="checkbox"/>	<input checked="" type="checkbox"/>	<input checked="" type="checkbox"/>	<input checked="" type="checkbox"/>	<input checked="" type="checkbox"/>	<input checked="" type="checkbox"/>	<input checked="" type="checkbox"/>
6.5	BOTH	<input checked="" type="checkbox"/>	<input type="checkbox"/>	<input checked="" type="checkbox"/>	<input checked="" type="checkbox"/>	<input checked="" type="checkbox"/>	<input checked="" type="checkbox"/>	<input checked="" type="checkbox"/>	<input checked="" type="checkbox"/>
6.6	BOTH	<input checked="" type="checkbox"/>	<input type="checkbox"/>	<input checked="" type="checkbox"/>	<input checked="" type="checkbox"/>	<input checked="" type="checkbox"/>	<input checked="" type="checkbox"/>	<input checked="" type="checkbox"/>	<input checked="" type="checkbox"/>
6.7	BOTH	<input checked="" type="checkbox"/>	<input type="checkbox"/>	<input checked="" type="checkbox"/>	<input checked="" type="checkbox"/>	<input checked="" type="checkbox"/>	<input checked="" type="checkbox"/>	<input checked="" type="checkbox"/>	<input checked="" type="checkbox"/>

FIGURE 5-70 LLDP MultiDevice Wizard for Single Device Options - Second Panel

To configure the many possible options, the following concepts are used:

- **ALL Ports** row - This row controls multiple actions as follows:
 - **Mode** - Selecting this cell brings up a pull-down of Modes, and selecting one means selecting the Mode for all ports on the device, including OFF, which disables LLDP for all ports.
 - **Notify** - Selecting this tic box toggles the Notify option for all ports between All On (with all ports in the column having the tic boxes checked) and All Off (with all tic boxes in the column blank).
 - **All options** - This allows the user to add all options to all ports or delete all options from all ports.
 - **Specific option** - For each option, selecting the tic box will Add or Delete the option for all ports.
- **Row for each port** - This row controls the options for each port as follows:
 - **Mode** - Selecting this cell brings up a pull-down of Modes, and selecting one means selecting the Mode for only that specific port.
 - **Notify** - Selecting this tic box toggles the Notify option on the port between ON and Disable.
 - **All options** - This tic box controls the state of all the options on the port
 - **Specific Option** - selects the specific option for the specific port.

Note: Setting any specific option for a will override a global options.

The user can then select **Finish** to bring up the Task Details window or **Next** to bring up the Task Schedule window.

5.3.13.3 LAG and VCS Support

The Physical Network Map shows the discovered devices and the physical connections (links) between them. The physical link icon between devices appears if the both devices support LLDP, and the NMS actively supports the LLDP functionality of the device.

Note: The physical links can also be manually created using the Link Operation function. Refer to 6.2.4.

On this Map, there is a feature that shows the LAG and Virtual Chassis Stacking (VCS) configuration.

- Stacked Devices - If a device is discovered to be set in a stacked configuration, its node will be rendered as two node icons stacked on top of each other, regardless of how many units comprise the stack. Moreover, the outline of the bottom icon is rendered blue if the stack is functioning normally, and orange if one or more members of the stack is unavailable. Refer to the following figure.

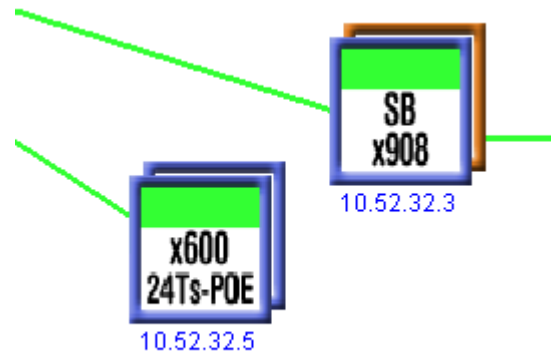

FIGURE 5-71 Icons for Stacked Devices - SBx908 has member of stack unavailable

- LAG - If two or more links are aggregated, forming a LAG connection, the LAG link is rendered as two parallel lines. Moreover, if both links are rendered as green, all links are available. If one of the two links is orange, then:
 - One or more links of the LAG is unavailable.
 - The neighboring port is not configured for LAG.
 - (AlliedWare type devices) - The port is not associated to any LACP channel.

Refer to the following figure.

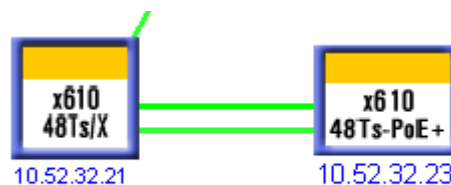

FIGURE 5-72 Icons for LAG links

- Layer 2 Links Screen - This screen shows the attributes of the links for the device and allows the user to create and add links. (You can access this screen by right-clicking on a device and selecting *Network Services -> Link Operations*.) The Link Type indicates LAG, as shown in the following figure.

Layer 2 Links						
Links for Node 10.52.32.21						
Link Name	From Device	From Ports	To Device	To Ports	Link Type	Discovered by
LINK-10.52.32.23-1.0.7--10....	10.52.32.23	1.0.7	10.52.32.21	1.0.7	LAG	LLDP
LINK-10.52.32.23-1.0.9--10....	10.52.32.23	1.0.9	10.52.32.21	1.0.9	LAG	LLDP
LINK-10.52.32.21-1.0.4--10....	10.52.32.21	1.0.4	10.52.32.2	1.0.5		LLDP

FIGURE 5-73

- **Show LAG Links** option - Right click on the LAG links icon and select **Show LAG Links** to bring up the LAG/VCS screen. Refer to the following figure.

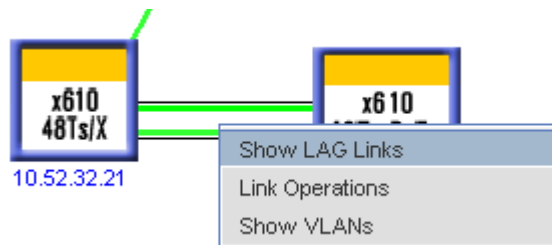

FIGURE 5-74 Accessing the Show LAG Links Screen

- **LAG/VCS screen** - This shows details such as the number of links that make up a LAG, the status of each LAG member, the port ID and LAG ID of each link, and, if VCS is configured as well, which stack member a LAG member is connected to. It also shows the endpoints, which can be non-stacked or stacked. Non-stacked endpoints have the same icon as for devices in the Physical Network Map. Stacked endpoints are shown as a stacked node, with each node representing a stack member. (Members are sorted from lowest to highest ID.) Finally, each link of the LAG is shown, where a link that is UP is green, and a link that is down or unavailable is shown as orange. Refer to the following figure.

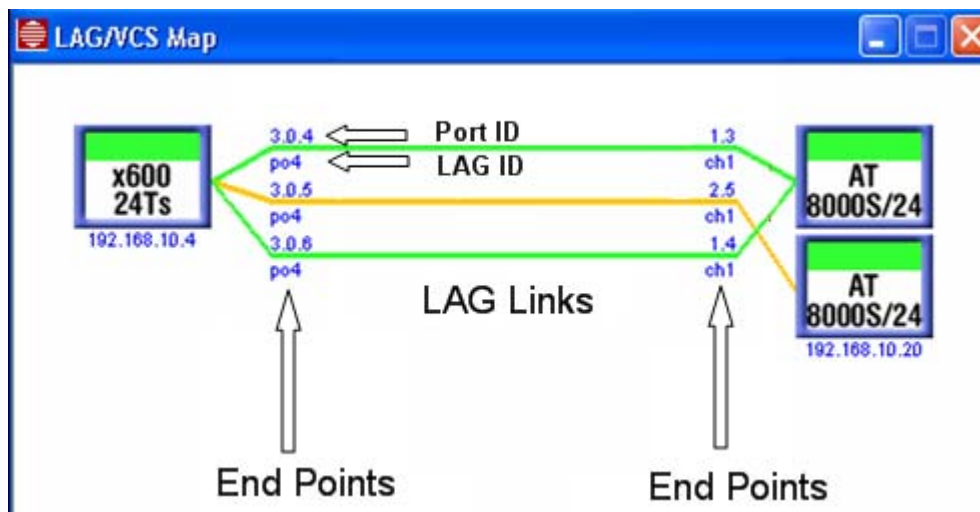

FIGURE 5-75 LAG/VCS Map Screen

The LAG ID can be as follows:

- **<LAG ID>** - Port is not down and LAG channel is up
- **Not Configured** - Port is not configured for LAG but the neighboring port is
- - (AlliedWare devices) - Port is not associated with any LAG Channel
- Chassis View - In the Chassis View for a device, ports that are members of a LAG are labeled “LA”. Note that the state of these ports cannot be changed (cannot change the state from <blank> -> T -< U).

5.3.14 MPEG Test

The MPEG Test feature allows the user to setup, monitor, and view the results of MPEG tests run on the iMG/RGs in a network. With the feature the user can set up a “Network Test” across multiple iMG/RGs in a network. Once set up, the Allied-View NMS runs an MPEG test on the selected iMG/RGs using the mpeg testing functionality included with the iMG/RGs devices. The AlliedView NMS collects the results of those tests and stores them in the NMS database, where they can be viewed. (Note that once a day test results are deleted that is older than seven days.)

To access the feature, the user accesses the application as described in 5.3.1. The user can also go to Network Inventory, select the RG table, choose the appropriate iMG/RGs, right click, and select MPEG Test from the pull-down. Refer to the following figures.

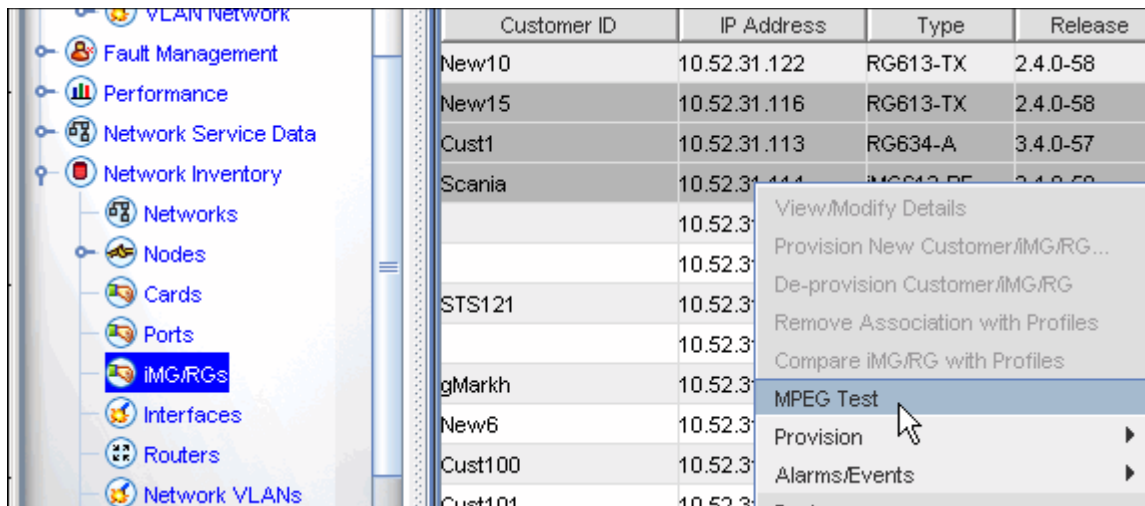

FIGURE 5-76 Example Method to Access MPEG Test Feature

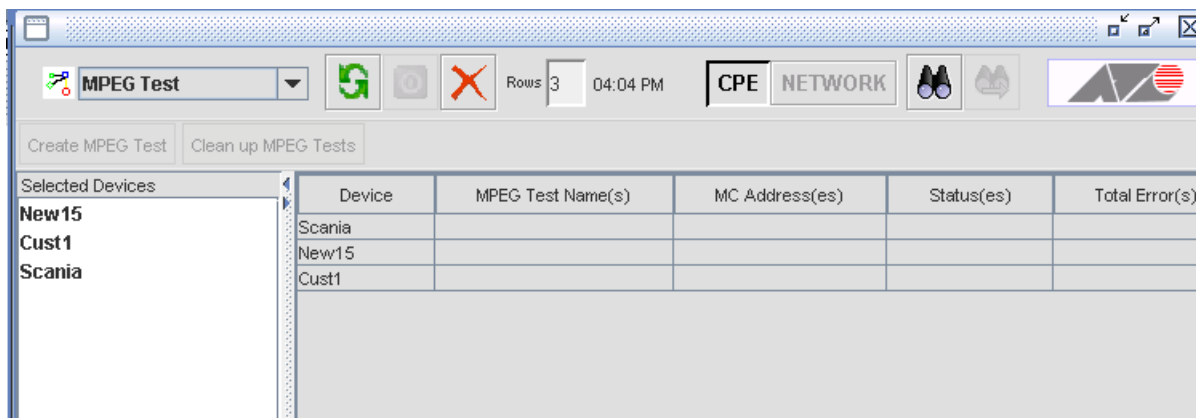

FIGURE 5-77 Initial GUI for MPEG Test Feature

To start the test, the user selects a set of iMG/RGs from the table and selects the now active “Create MPEG Test” button. This brings up the Create MPEG Test Form, shown in the following figure.

FIGURE 5-78 Create MPEG Test Form

Fields to datafill are:

- Test Name - This should be descriptive, and becomes the Name of the test in the Task List Details window.
- Channel List - The multicast IP address(es) for the channel(s) to be tested. If multiple channels are entered, each channel will be tested sequentially. (If multiple iMG/RGs were selected, all iMG/RGs will be tested simultaneously.) Example values would be 225.1.1.11, 225.1.1.18
- Video Middleware Server Port - The port of the video server to be used, such as 2001.
- Duration - Length the test will run, in seconds
- Temp. IP Address - The default is 10.0.0.254
- Temp Subnet IP Address - The default is 255.255.255.252

Selecting Finish starts the test immediately, or the user can select Next to create a schedule, as shown in the following figure.

The screenshot shows a Java Application Window titled "Create MPEG Test" with a "Recurring Schedule" tab. The "Schedule" section has four radio buttons: "Now", "Hold", "One Time", and "Recurring". The "Recurring" radio button is selected. Under "One Time", there are four dropdown menus showing "Aug 24, 2006", "4", "14", and "PM". Under "Recurring", there is a "Recur Every" field with "30" and "minutes". Below that is a "Time:" field with three dropdown menus showing "2", "15", and "AM". There are two options for "Recur Weekly" and "Recur Monthly on the". The "Recur Weekly" option is selected, with checkboxes for "Sun", "Mon", "Tue", "Wed", "Thu", "Fri", and "Sat", where "Sat" is checked. The "Recur Monthly on the" option is not selected, but it shows a dropdown menu with "1st" and "of the month". At the bottom, there are five buttons: "< Back", "Next >", "Finish", "Cancel", and "Help".

FIGURE 5-79 Create MPEG Test - Recurring Schedule

For the recurring schedule, the user can choose:

- Now - Clicking on Finish starts the test immediately.
- Hold - This sets no time; the test is activated through the View Tasks window.
- One Time - Sets one time only to run the test
- Recurring - This is set on a minute basis and can be one time, a specific time every week (shown in the above figure), or a specific time on a day of the month. (Selecting 29-31 of month means those months that do not have those numbered days will skip the test for that month.)

As with other applications, once the test is created, the user can view the parameters and the schedule of the test by bringing up the “View Tasks” window, selecting a MPEG Test task, and pressing the “View Details” button.

To access the results of the test, open the Network Service Data leaf in the main tree and select Test Results, as shown in the following figure.

Test Name	Type	Num Dev.	Status	Time	Results
Sample_MPEG_Test	MPEG Test	3	3 of 3 successful	2006 08/24 18:25...	MPEG Errors: 0

FIGURE 5-80 Viewing Test Results for MPEG Test

To review specific test results, double-click on a row in the table or right click on a row and select View Test Result MPEG Test Results Details panel, as shown in the following figure.

Test Name: Sample_MPEG_Test
 Test Type: MPEG Test
 Status: 3 of 3 successful
 Execution Time: 2006 08/24 18:25:12
 Result: MPEG Errors: 0

Device	MC Address	CPU Load	NP Load	Frames	Kbytes	Total Errors
New15	225.1.1.11	peak(21 %) - aver...	peak(2 %) - avera...	38066	6988	0
New15	225.1.1.18	peak(21 %) - aver...	peak(2 %) - avera...	38017	6979	0
Cust1	225.1.1.11	peak(34 %) - aver...	peak(4 %) - avera...	38171	7007	0
Cust1	225.1.1.18	peak(35 %) - aver...	peak(4 %) - avera...	38164	7006	0
Scania	225.1.1.11	peak(21 %) - aver...	peak(2 %) - avera...	38017	6979	0
Scania	225.1.1.18	peak(21 %) - aver...	peak(2 %) - avera...	38017	6979	0

Row Data Options:
 All Data Combine Device Data Combine Channel Data

Close

FIGURE 5-81 Results of MPEG Network Test Execution - All Data

The “Combine Device Data” Radio button combines all the data from each iMG/RG into a single row entry, as shown below.

Test Name: Sample_MPEG_Test
Test Type: MPEG Test
Status: 3 of 3 successful
Execution Time: 2006 08/24 18:25:12
Result: MPEG Errors: 0

Device	MC Address	CPU Load	NP Load	Frames	Kbytes	Total Errors	TS Sync Loss
Cust1	-	-	-	76335	14013	0	0
Scania	-	-	-	76034	13958	0	0
New15	-	-	-	76083	13967	0	0

Row Data Options

All Data Combine Device Data Combine Channel Data

Close

Java Application Window

FIGURE 5-82 Results of MPEG Network Test Execution - Combine Device Data

The “Combine Channel Data” Radio button combines all the data from each multicast into a single row entry, as shown below.

MPEG Test Result Details

Test Name: Sample_MPEG_Test
Test Type: MPEG Test
Status: 3 of 3 successful
Execution Time: 2006 08/24 18:25:12
Result: MPEG Errors: 0

Results

Device	MC Address	CPU Load	NP Load	Frames	Kbytes	Total Errors	TS Sync Loss
-	225.1.1.11	-	-	114254	20974	0	0
-	225.1.1.18	-	-	114198	20964	0	0

Row Data Options

All Data Combine Device Data Combine Channel Data

Close

Java Application Window

FIGURE 5-83 Results of MPEG Network Test Execution - Combine Channel Data

To delete the test results, select one or more tests from the Test Results panel, right click, and select Delete Test Result. (Note that View Test Result is grayed out.) Refer to the following figure.

Test Name	Type	Num Dev.	Status	Time	Results
Sample_MPEG_Test	MPEG Test	3	3 of 3 successful	2006 08/24 18:25:12	MPEG Errors: 0
Sample_MPEG_Test	MPEG Test	3	3 of 3 successful	2006 08/24 18:29:13	MPEG Errors: 0
Sample_MPEG_Test	MPEG Test	3	3 of 3 successful	2006 08/24 18:31:13	MPEG Errors: 0
Sample_MPEG_Test	MPEG Test	3	3 of 3 successful	2006 08/24 18:33:13	MPEG Errors: 0
Sample_MPEG_Test	MPEG Test	3	3 of 3 successful	2006 08/24 18:35:13	MPEG Errors: 0
Sample_MPEG_Test	MPEG Test	3	3 of 3 successful	2006 08/24 18:37:13	MPEG Errors: 0
Sample_MPEG_Test	MPEG Test	3	3 of 3 successful	2006 08/24 18:27:13	MPEG Errors: 0

FIGURE 5-84 Deleting MPEG Test Results

To modify the schedule/recurrence of a test, select **Tools -> View Tasks**, and select the Task Name (the Name entered for the test) from the View Tasks table. Select **View Details**, and then the **Modify Schedule** button. Note that only the time of the test, not the other attributes, can be changed.

The steps to delete an MPEG test is similar to modifying its schedule. Select the Task Name (in this case Sample_MPEG_Test) and Click on **Remove**. This does not remove the results that the test produced; however, every day test results older than seven days are removed from the database.

To clean up the MPEG tests that have been run on multiple iMGs/RGs, the button **Clean up MPEG Tests** has been added in release 10.0 SP2. The user selects the iMGs/RGs, and the button is activated. When selected, the Clean up MPEG Tests panel appears, with the iMGs/RGs listed. The user can then select Finish to perform the clean up immediately, or Next to bring up a schedule. Refer to the following figure.

Note: These tests are usually ones that have failed for some reason, or been saved.

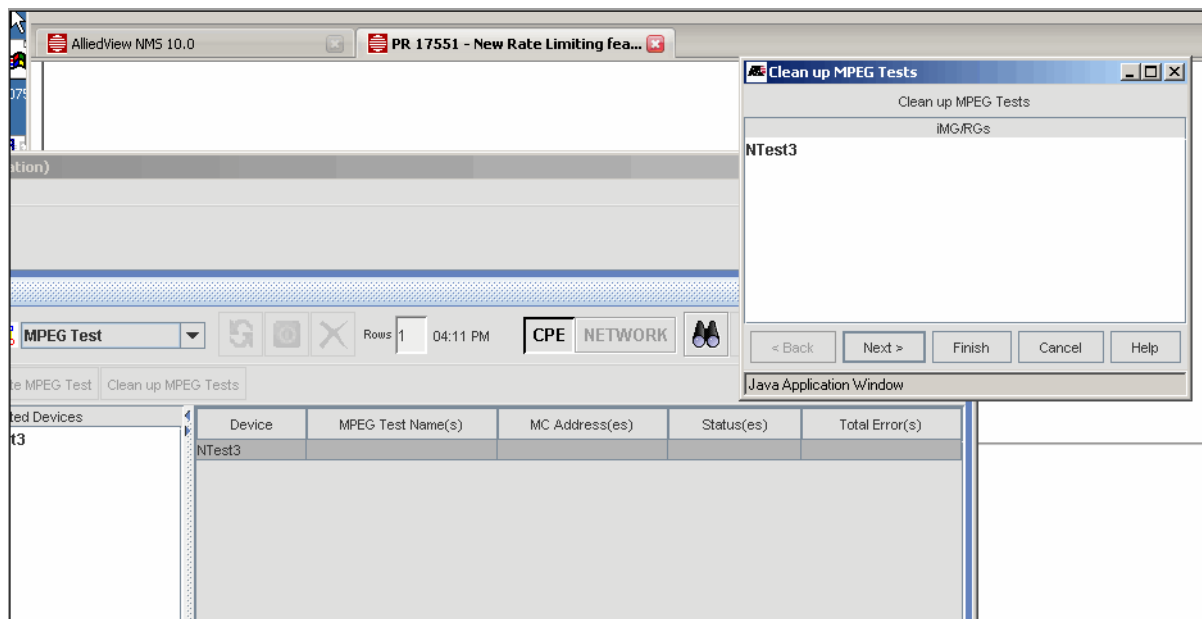

FIGURE 5-85 MPEG Test Clean Up Panel

5.3.15 Using the Edit Functions

The Edit window has the same functions for both the Command Script Management and Configuration File Management functions, and so the explanation for how the window works can apply to both types of files.

In the Command Script application, the **Edit** window brings up the unloaded multi-paged editor. The editor has Open and Save as buttons that work with the server file system. Selecting **File -> Open** in the **Edit** window brings up the NMS file system in the **Open** window. From the **Open** window, a file can be chosen. The **File -> Save** option uses whichever file was opened. The editor also has find, find next, and cut/copy/paste options.

When a file is open, the file text appears. In the following example a script file is opened. Refer to [Figure 5-86](#).

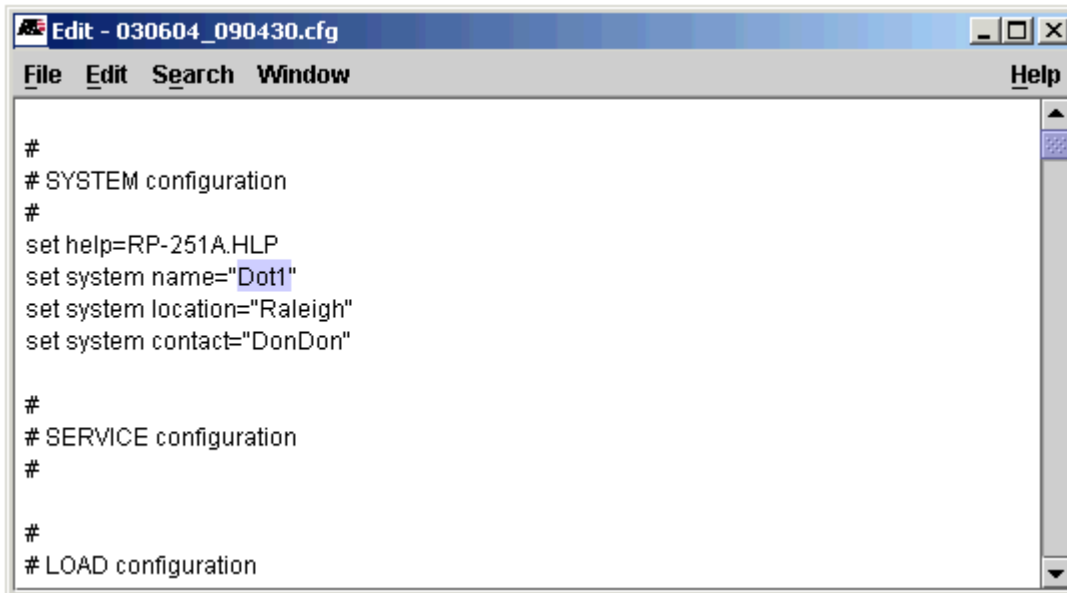

FIGURE 5-86 Edit Window for Script Mgt Files

In the Configuration File Management application, the Edit button will display, if it is shown in the Default File column, the default configuration file. Otherwise it will display an open Edit window, the same as the Command Script application.

5.3.15.1 File Menu

The **File** menu contains conventional options. **Open** and **Save As** can access the client's file system or the server's file system depending on a toggle on the file chooser dialog. **Save** will save the current file to whichever file system from which it was opened. **Close** and **Close All** are required since this is a multi-page editor. Refer to [Figure 5-87](#) for the **Edit** window and the **File** pull-down menu. The example is for a command script file.

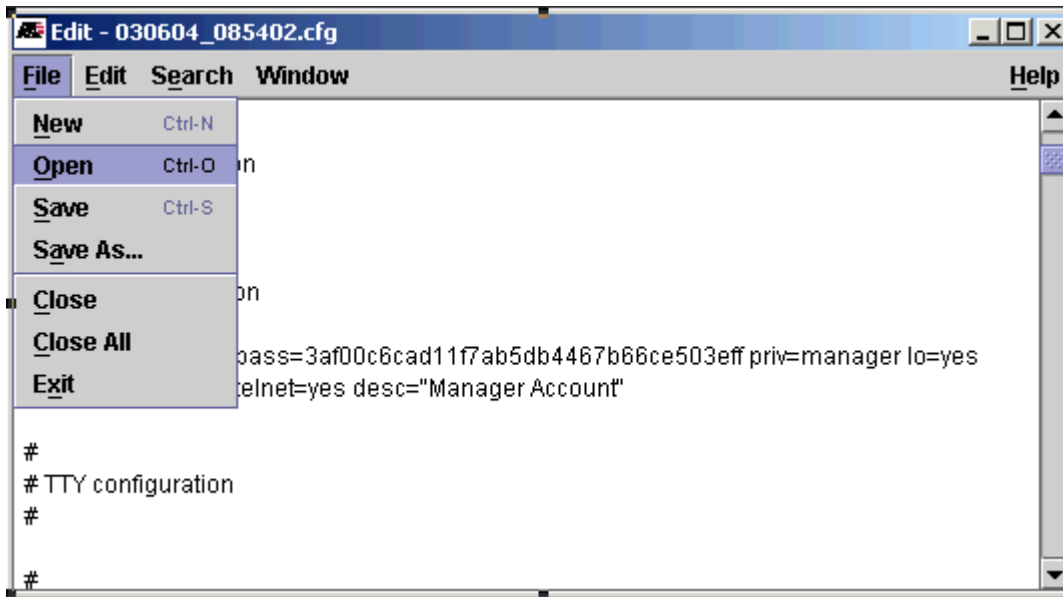

FIGURE 5-87 File Pull-down for Edit of Scripts

Selecting the *File -> Open* menu item brings up a listing of the latest files from the server file system for the devices highlighted on the **Command Script Mgmt** panel when the editor was launched. Files can be viewed as a simple list or with details (Size, Type, when Modified). Template files can also be created and included. Refer to [Figure 5-88](#) and [Figure 5-89](#).

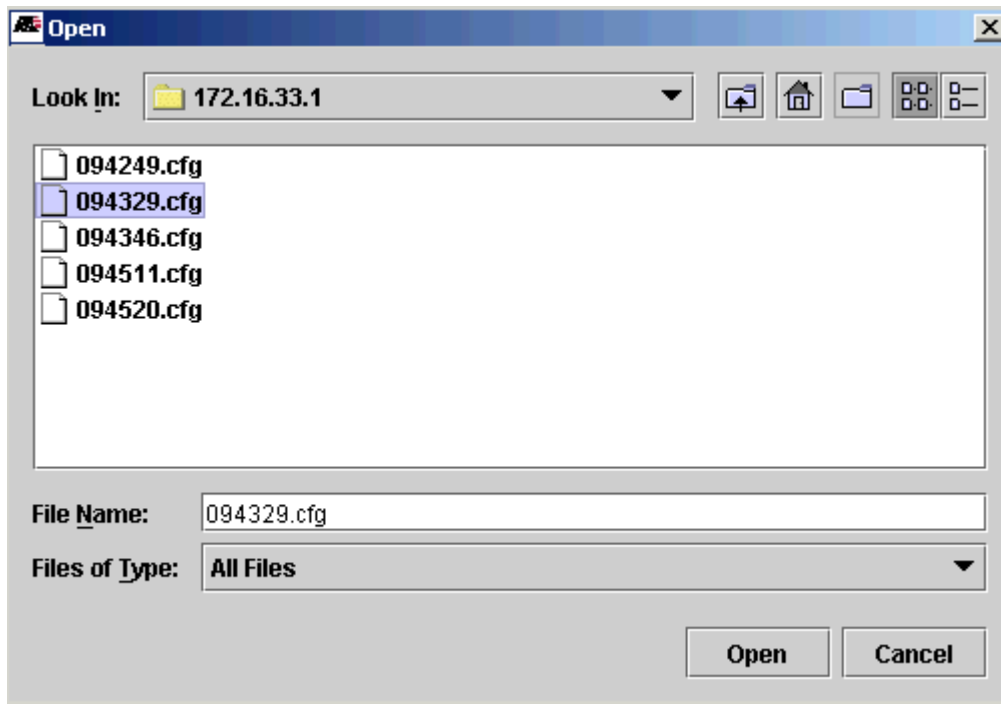

FIGURE 5-88 Files Available for Edit from Server File System (List View)

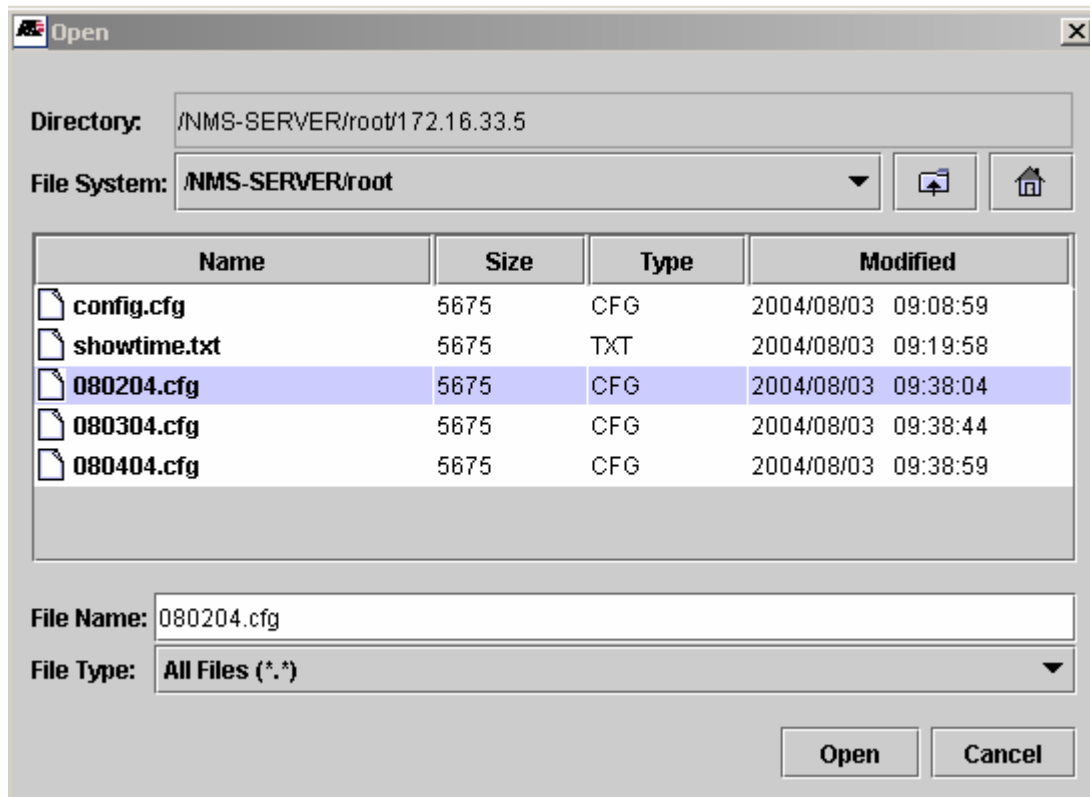

FIGURE 5-89 Files Available for Edit from Server File System (Details View)

Once a file is opened and edited, it can be saved on the Server File System. Files can be saved as templates for future script writing. Refer to [Figure 5-90](#).

Note: Since files are being saved to the server (rather than a device), unrestricted filenames and extensions are allowed.

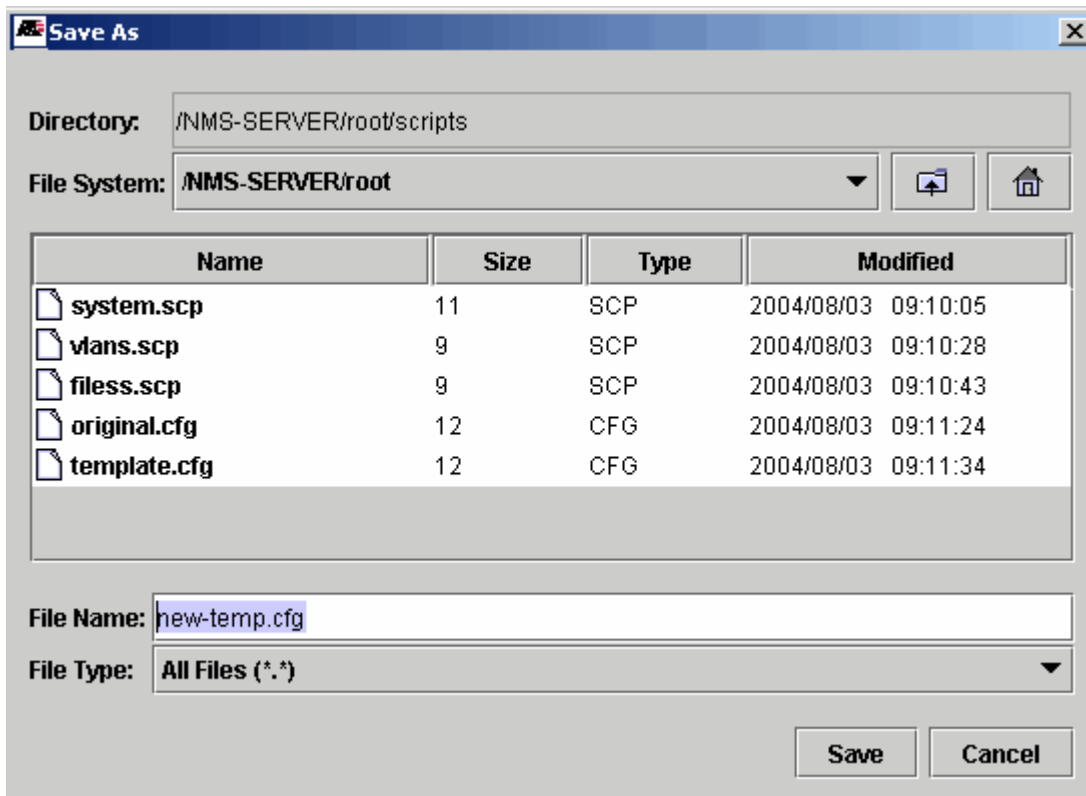

FIGURE 5-90 Saving Files after Editing

5.3.15.2 Edit Menu

The *Edit* menu has conventional options (CUt, Copy, Paste, Delete, Select All). Right-clicking in the text area will bring up these options as well. Refer to [Figure 5-91](#).

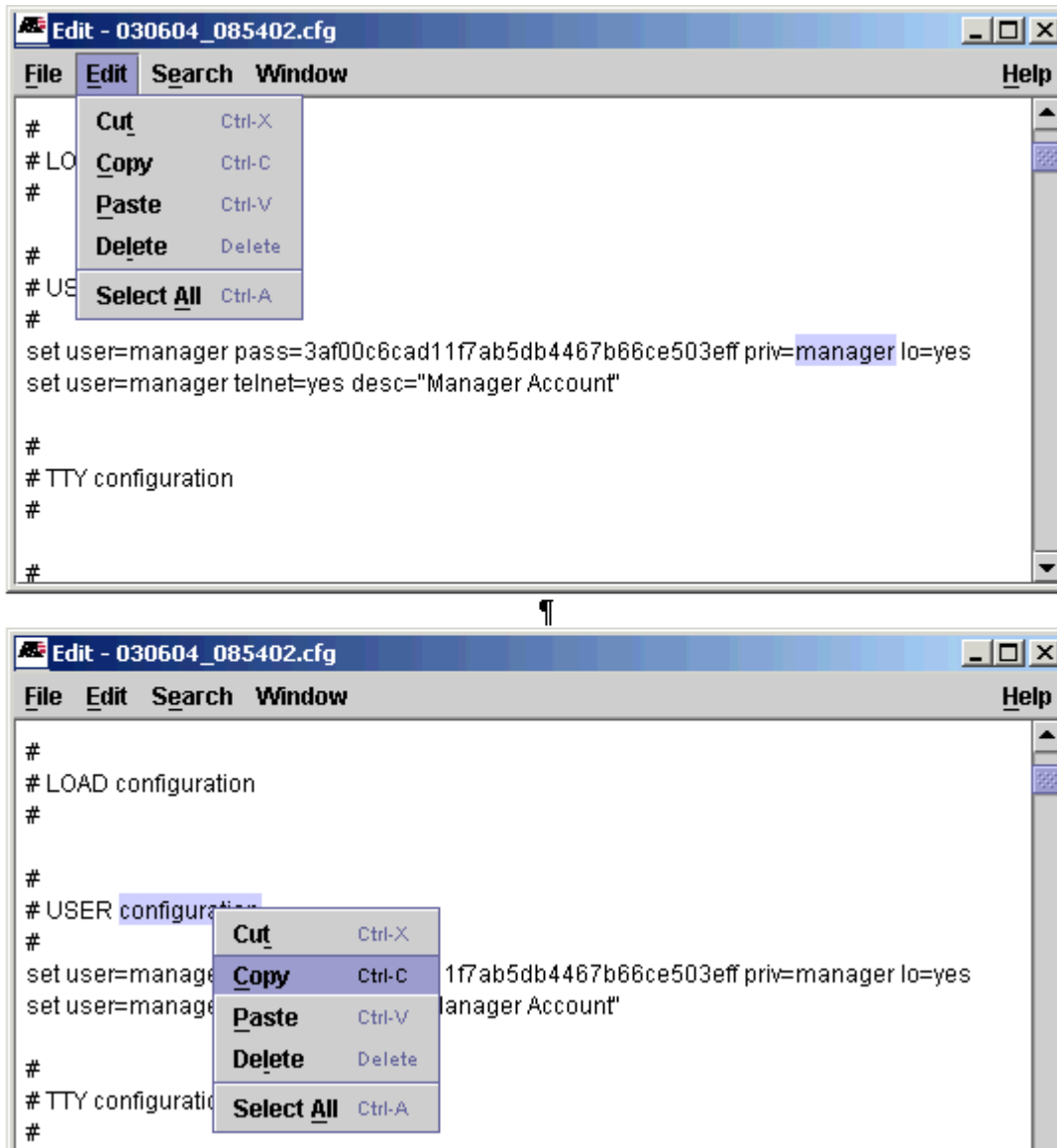

FIGURE 5-91 Edit Menu Options for Text Files

5.3.15.3 Search Menu

The *Search* menu provides for searching within the current window. Conventional *Find* and *Replace* options are provided. Refer to the following figures.

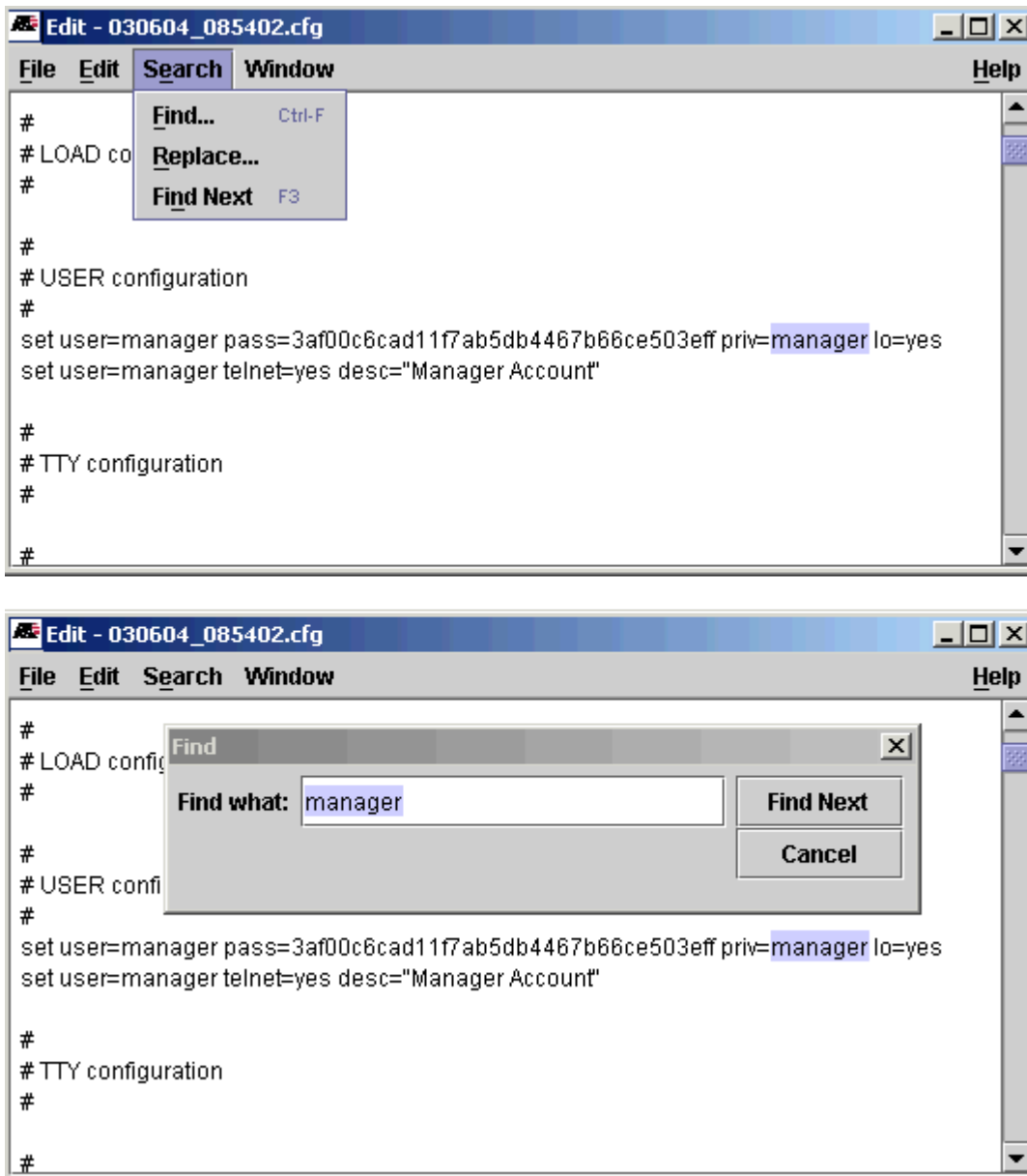

FIGURE 5-92 Search Find Option

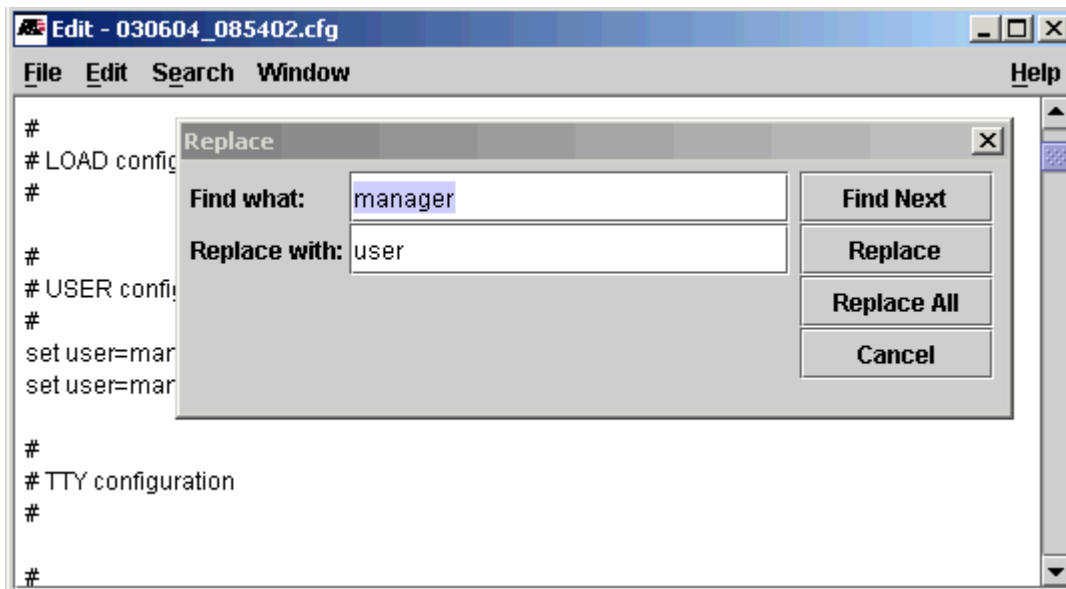

FIGURE 5-93 Search Replace Option

5.3.15.4 Window Menu

The Window menu provides changing between open files. Each time a file is entered, the cursor, text selections, and scroll bar are in the same state they were in when that file was left. The Window menus changes dynamically as files are opened, created, and closed.

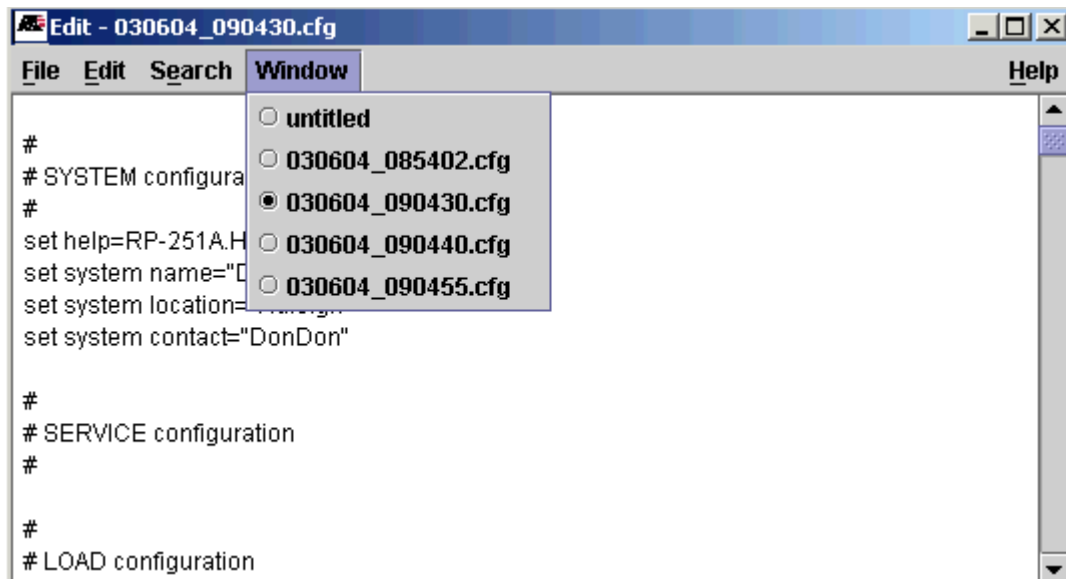

FIGURE 5-94 Window Menu for File Editor

5.3.16 Using the Delete Function

The **Delete Files** Button invokes the same window for both Command Script Management and Configuration File Management, and so the explanation for how the window works can apply to both types of files.

With no devices selected, the Delete button brings up a file chooser that provides navigation among all the user's directories and lets the user delete one or more files from the same directory. Select one or more files to delete:

When the files for deletion for a device are listed, the user can select the details icon and see the file properties, as shown in the following figure.

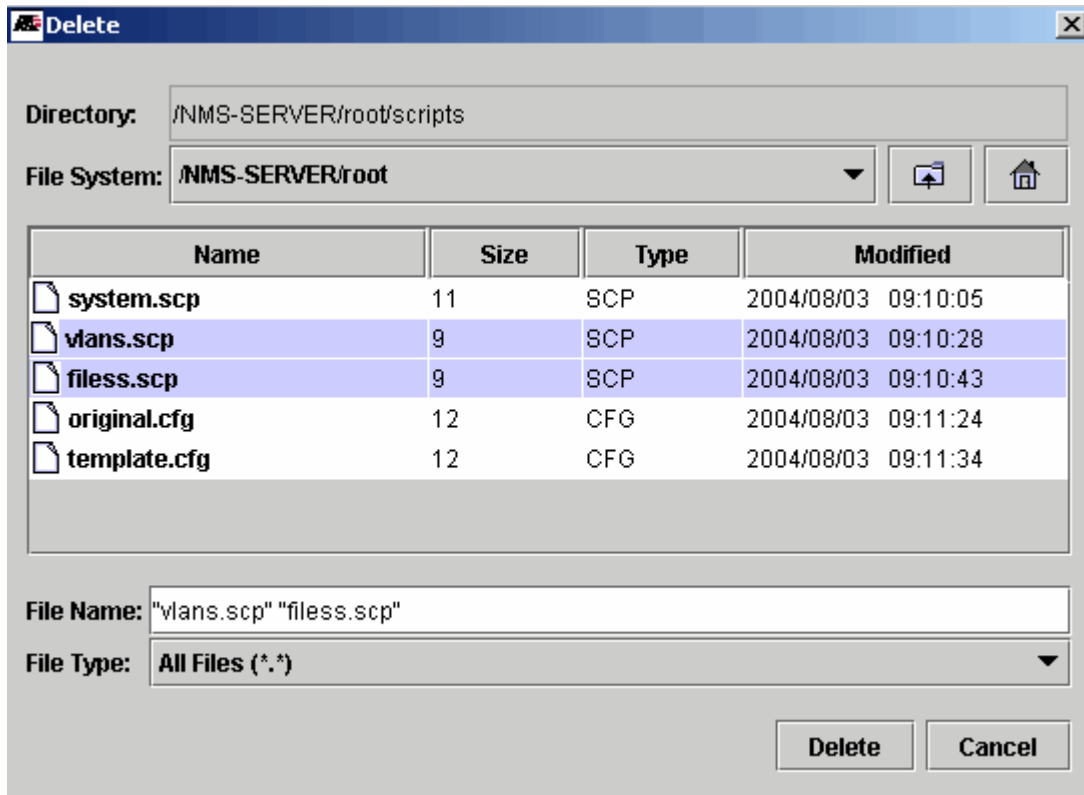

FIGURE 5-95 Delete File Window for Multiple File and Properties

The current directory is displayed at the top. Just below is a pull-down combo box that can be used to jump between file system roots—in this case /NMS-SERVER/root/scripts and /NMS-SERVER/root. The folder and home icons can be used to navigate up in a directory tree or to jump to the “home” directory, which is usually the user's home directory. File properties (size, type, and date last modified) are always displayed. File types can be filtered with the pull-down combo box at the bottom.

The Delete button will prompt to confirm the files to delete, as shown in the following figure.

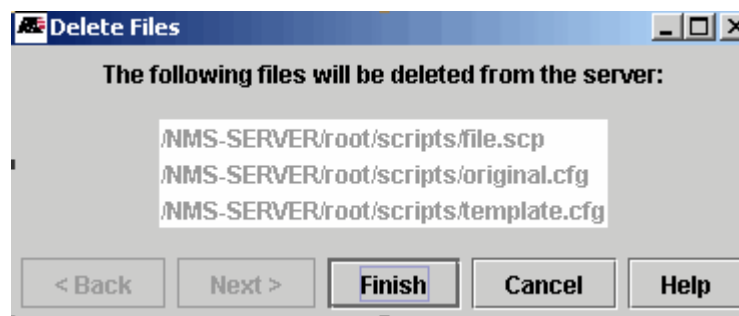

FIGURE 5-96 Confirm Files to Delete

With one or more devices selected, a Multi-File Delete wizard pops up instead of the file chooser. For a single device, this wizard lists all the files in the user's device directory and provides no way to navigate to other directories. It provides a quicker way to delete one or more files for a single device. Refer to the following figure.

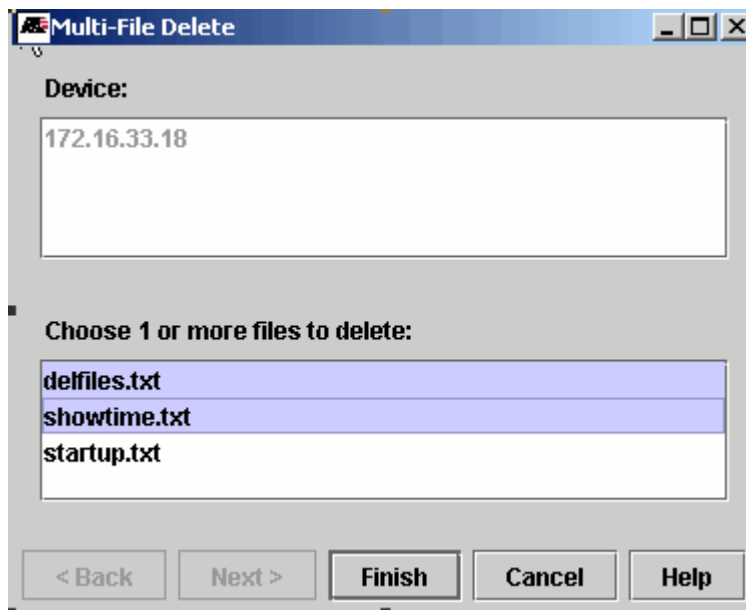

FIGURE 5-97 Multi-File Delete Window

With two or more devices selected, this wizard displays all the files with names *common to all the selected devices*. Files with any other names will be left out. No file properties or pathnames can be displayed since they may differ among the various devices even though the file names are the same. This wizard will delete selected files from all the device directories in one operation. Refer to the following figure.

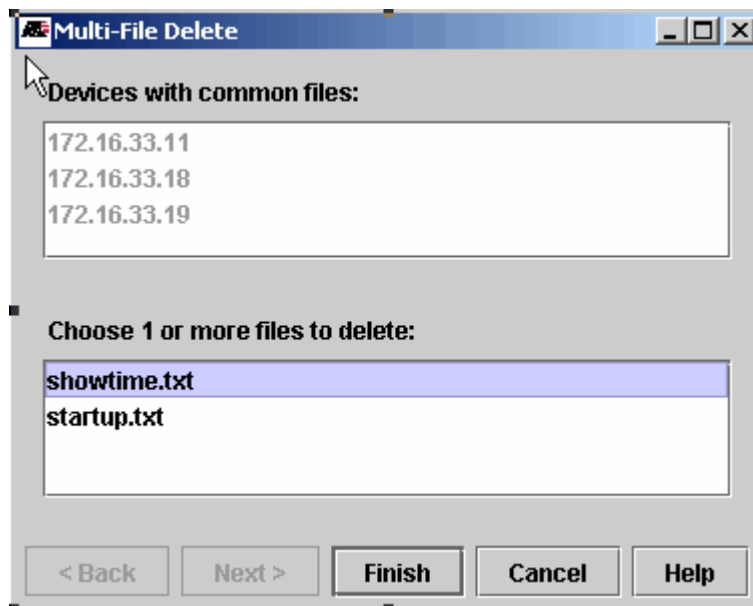

FIGURE 5-98 Multifile Delete Window - Files Common to All Devices

If there are no common files among the selected devices, and error message pops up, **There are no common files for the selected devices.**

Note: Files in the user's scripts directory are not associated directly to a device and can therefore only be deleted with the file chooser version of this dialog (brought up with no devices selected).

5.3.17 SNMPv3 USM Configuration

This SNMPv3 uses the User-Based Security Model (USM) and is specified in RFC2574. The USM has the concept of multiple users where each user provides secret keys for authentication and privacy. The authentication protocols specified for use are HMAC-MD5 and HMAC-SHA. The privacy protocol specified is CBC-DES.

From the panel the administrator can activate this model for one or devices, similar to other MDTI applications.

The fields filled in when the administrator creates an SNMPv3 user.

Refer to the following figure.

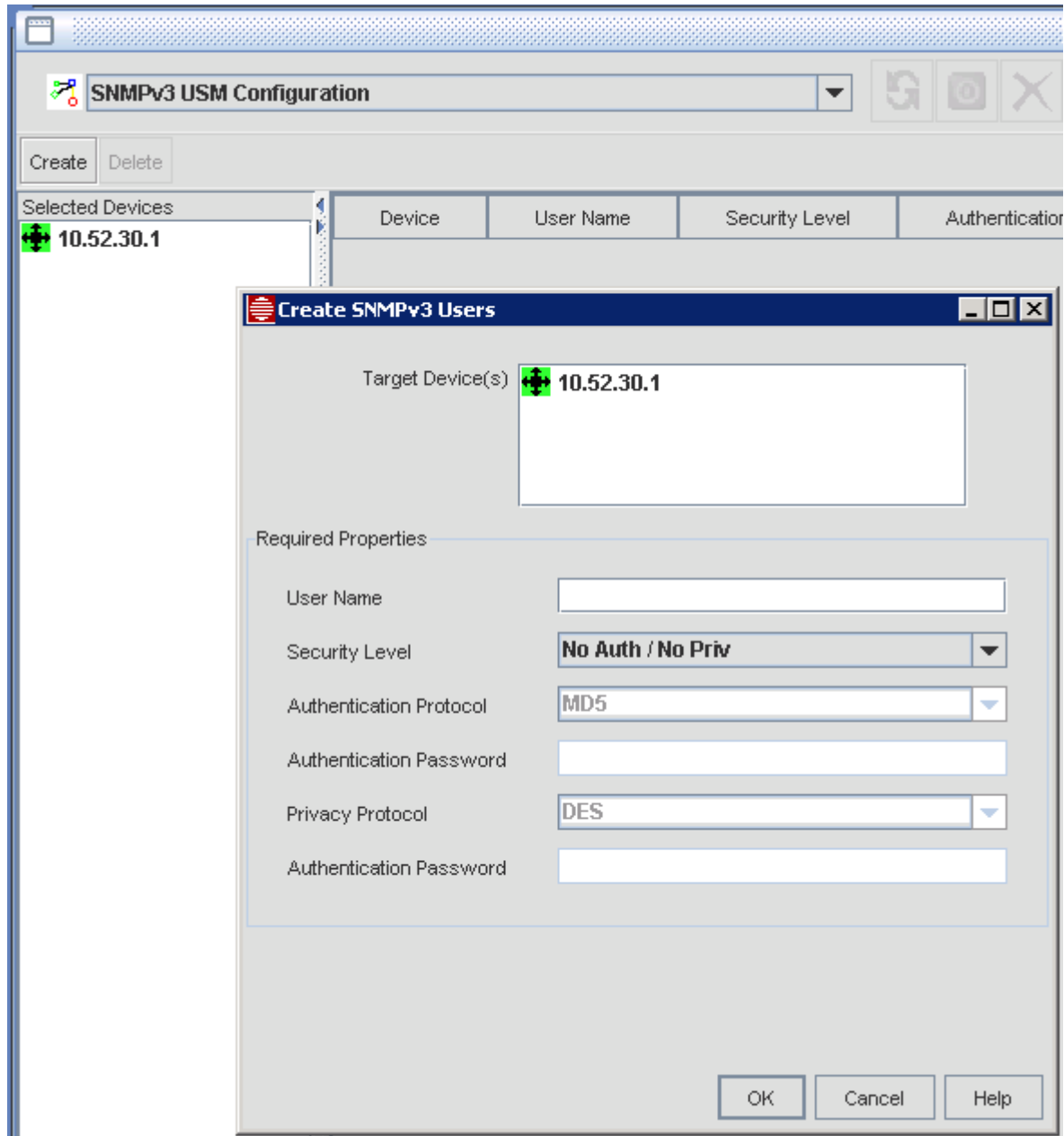

FIGURE 5-99 SNMPv3 USM Configuration Panel

5.4 Configure VLAN (Chassis View)

To configure a VLAN for a single device, right-click the device, and then select **Provision -> Configure VLAN**. The VLAN chassis configuration screen will open immediately and fill in the present VLAN configuration. Refer to the following figures for examples of the configuration screen.

Note: The Chassis view and VLAN Configuration view are combined, but the VLAN-related information will change depending on the VLAN interface chosen.

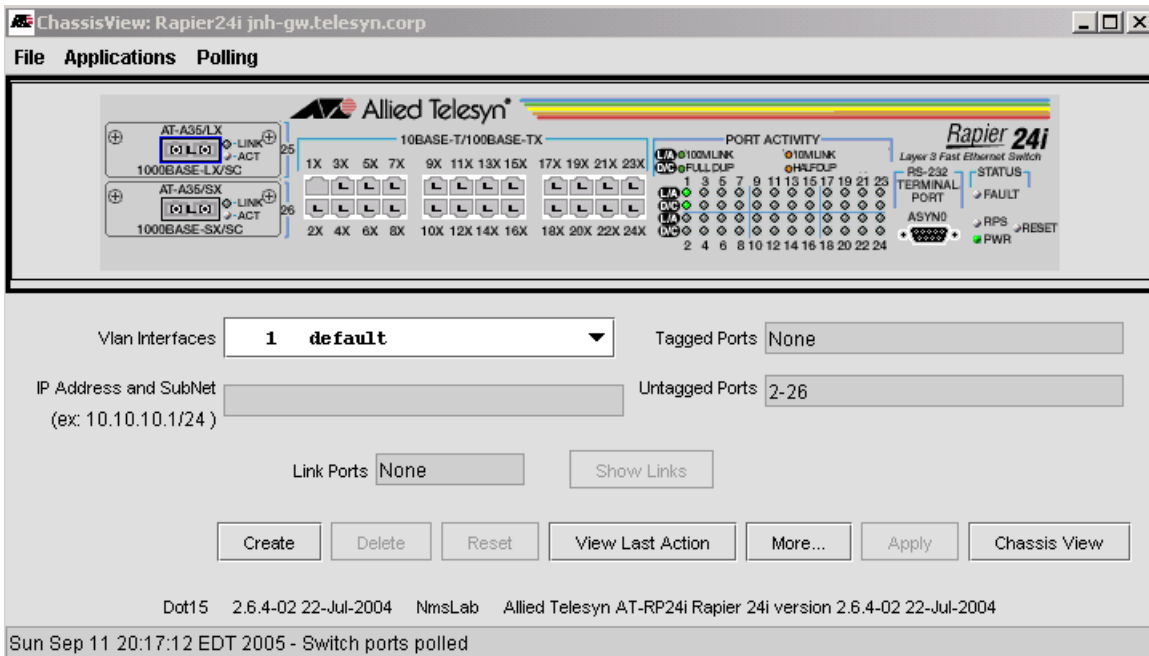

FIGURE 5-100 VLAN Configuration Screen (Rapier Device)

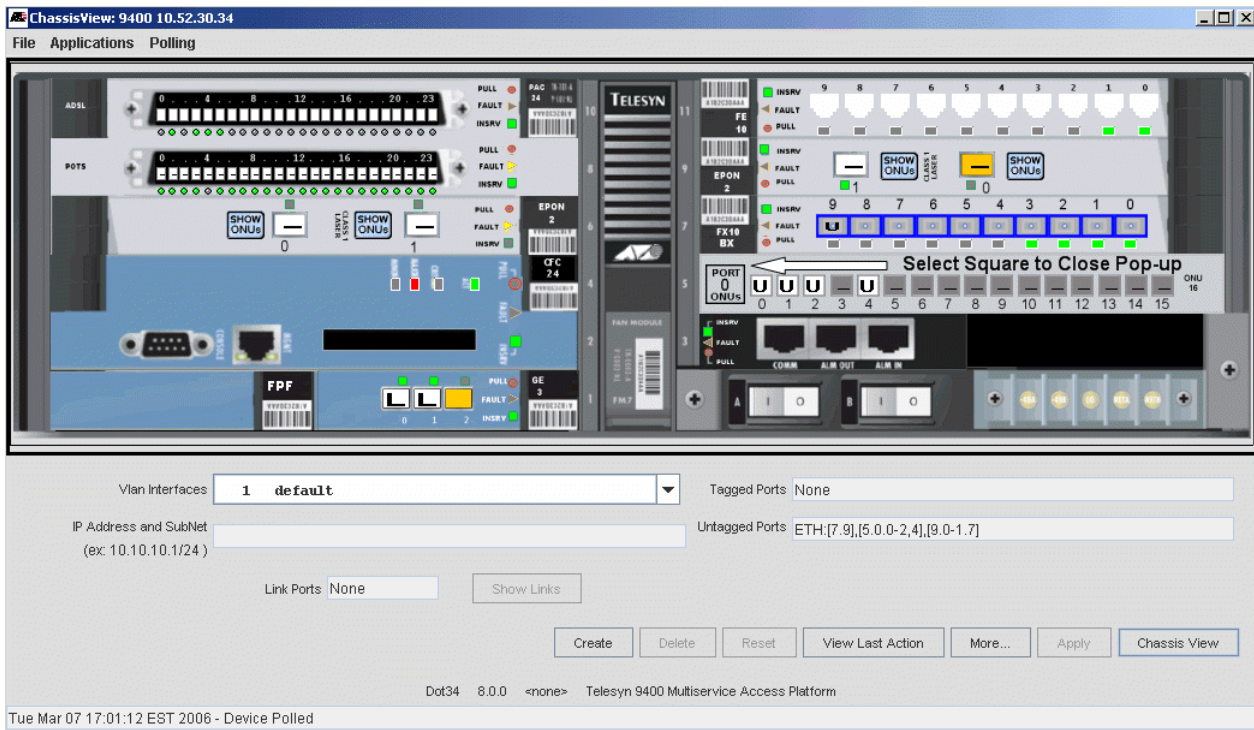

FIGURE 5-101 VLAN Configuration Screen (iMAP Device)

The following table gives an overview of the fields, graphics, and buttons available.

TABLE 5-12 VLAN Configuration Options

Screen Item	Description
Create	If creating a VLAN on the device, select this button first. You will see a Create New VLAN form. Fill in the Name and ID, and then click OK , and the VLAN is added to the Vlan Interfaces pull-down.
Vlan Interfaces	The VLAN interfaces available on the device. This includes all VLAN interfaces.
IP Address and Subnet	If this Vlan interface is part of an IP-based Network VLAN, this is included. The format is the IP address and the subnet mask. The subnet can be specified by a forward slash and the mask as a number of bits (e.g. /24) or by a space and the full dot notation (e.g. 255.255.255.0).
Untagged Ports	For the selected VLAN interface, the ports that are reserved. On the graphic, these have the capital letter U .
Tagged Ports	For the selected VLAN, the ports that are reserved and active. On the graphic, these have the capital letter T .
Translated Port	For the selected VLAN, allows the user to specify the VLAN on the customer side of the port that will be translated into the selected VLAN. When selecting X , the user will see a pop-up window that allows the user to input the translate from ID. Once entered, these have the graphic capital letter X .
VC-0 through VC-3 buttons	When more than one VC has been associated with a VLAN, each button, when selected, show the VLANs which have that VC provisioned. (This is for iMAP devices only.)

TABLE 5-12 VLAN Configuration Options

Screen Item	Description
Link Ports	These are the ports that are used for connection to another device and are used as part of one or more Network VLANs including the current VLAN. On the display, these will be identified with the capital letter L . A Link Port cannot be changed from the VLAN Configuration screen. It must be changed on both ends of the link using the Create Vlan, Extend Vlan, or Delete Link applications. However, a Link Port can be changed in the VLAN Interface Configuration application, which is a similar application that is launched on VLAN interfaces either from a VLAN Map or a VLAN Interface row in one of the Inventory tables. In this application, Link Ports can be toggled from L (not part of the VLAN) to lu (linked untagged), to lt (linked tagged). This is useful for repairing VLAN entries that have become inconsistent with the entry for the device at the other end of the link
Rapier Specific Vlan Parameters	These apply only to VLANs on Rapier-type devices, and are divided into two areas: 1. Device Wide Parameters - These are read -only and display device-level attributes as Enabled or Disabled: - IGMP Status - IP Multicast Hardware Switching - OSPF Status - PIM Status 2. VLAN Interface Parameters - These are read-write and apply only to the selected VLAN: - IGMP Enabled - OSPF Area - Set the Open Shortest Path First Area - OSPF Metric - Set the Open Shortest Path First Metric - PIM Mode
iMAP Specific Parameters	These apply only to iMAP devices, and are divided into two areas: 1. Device Wide Parameters - These are read -only and display device-level attributes as Enabled or Disabled: - Access Interface - This is the IP interface the device is using to communicate with the NMS. Options are MGMT (for the Ethernet interface that transports only management data packets) or the IP address of inband interface (in-band Ethernet interface that interleaves user data packets with management data packets on the uplink, using a VLAN interface). - IGMP - Whether IGMP has been Enabled or Disabled for the device 2. VLAN Interface Parameters - These are read-only and apply only to the selected VLAN: - Double Tagged (HVlan) - If the selected VLAN is an HVLAN (and will therefore be a VLAN used to switch the traffic across the network), this is shown as TRUE. Refer to Section 6. - Translation Ports - When the VLAN chosen is a translation VLAN (where a service provider takes a customer VID and translates it into a unique VLAN ID for transport across the network), this field contains the ports the translation VLAN ID resides on. Refer to Section 6. Note that HVlan and Translation are mutually exclusive features.
Create	Create a new VLAN. A Create New VLAN form will appear, with the default name and number one that has not been used yet.
Delete	Allows the user to delete the selected VLAN. (Note that since the default VLAN [VID 1] cannot be deleted, this button is inactive when the selected VLAN is VLAN 1.)
Reset	Cancels the changes that were made using the graphic. The graphic reverts to the original port assignments.
Apply	Makes and confirms the port assignment changes. If any errors occur, (such as a conflict with another user making port changes), there is an error message and the history window is displayed.
Less/More	This shows/hides the additional attributes, one for Rapier-specific Vlan parameters, one for iMAP-specific VLAN parameters, such as specific translations. These are explained above.
Show Links	If the VLAN is configured as part of a Network VLAN, selecting this button will show the physical links over which the logical VLAN links are configured.

TABLE 5-12 VLAN Configuration Options

Screen Item	Description
View Last Action	This will open up the Recent Commands... window and show what command and response were involved in the last action on the form.
Close	Closes the form. <i>Note: If this VLAN Configuration form is invoked from the Chassis View, the Close button is replaced with the Chassis View button, to return to the first view of the device.</i>

Note: To see the status of a port, place the cursor over a port in the graphic and a tooltip appears, which shows the permitted states for that port. Allowed states are Plain, Tagged, Untagged, Linked-Tagged, Unlink-Tagged, Linked, and Translated. (The actual states available depend on the configuration.) If a port is Plain, the user can then click on the port and cycle the status from U (untagged) to T (tagged) to X (translated). Clicking on the port again will return the port to blank. When a port is marked as untagged for a VLAN other than the default VLAN, that port can only be marked as tagged for the other VLANs. In this case the port alternates only between tagged and blank.

Note: For the EPON2 card, the user can click on the ONUs button and a pop-up will show the VLAN status of the ONU ports. To close the pop-up, click on the square labeled Port <no.> ONUs, as highlighted in Figure 5-101.

Note: To change the status for a set of ports, select and hold the SHIFT key and then click and drag the left mouse button over multiple ports.

Caution: The FE/FX10 cards have certain restrictions on VLAN translations, and the user must be aware of these so as not to compromise service. Refer to [6.9.3.2](#).

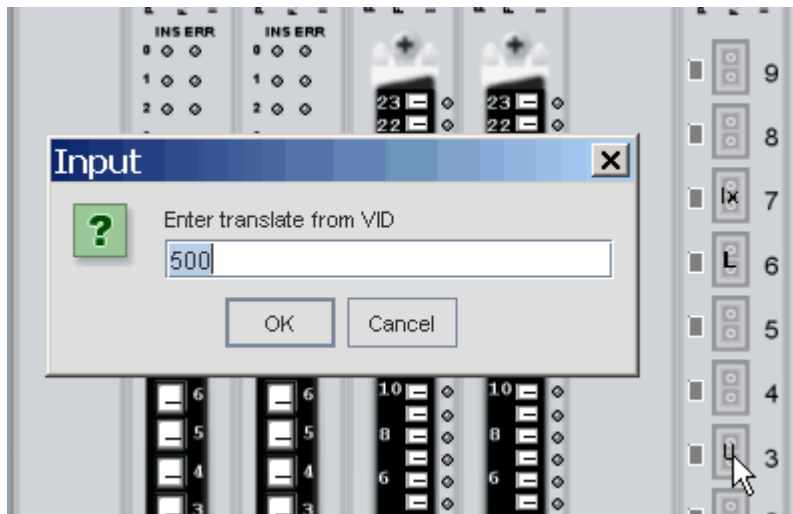

FIGURE 5-102 Entering a translated VLAN (State will go from U to X)

5.5 Card Management

5.5.1 Overview

This application for the iMAP 9000 and SBx3112 devices allows the user to view, in a table format, the configuration of the device and then provision/configure its cards. Moreover, this table is updated real time as changes occur to the cards.

Note: Controlling the card configuration involves understanding how provisioning data works in the iMAP devices, so an overview of provisioning data is given after the description of the application.

Note: Throughout this Section, the Card Management Forms have the following common buttons:

- Recent Commands... - This brings up the Recent Commands window, a listing of the CLI commands and responses for the previous operation in the Card Management application. The user has the option to copy this to a Clipboard and then paste it into another file for record keeping.
- Close - This closes the Application.
- Help - This brings up the context-sensitive help file.

The cards available are as follows:

- GE3 - 5.5.4
- GE8 - 5.5.5
- ADSL - 5.5.6
- SHDSL - 5.5.8
- CFC24/56/100/200 - 5.5.9/5.5.10
- FE10/FX10/FX20 - 5.5.11
- POTS24 - 5.5.13
- CES8 - 5.5.14
- NTE8 - 5.5.15
- PAC24 - 5.5.17
- EPON2 - 5.5.18
- VDSL24A/B - 5.5.19
- ADSL48A/B - 5.5.20
- 9100 - 5.5.21
- GE24POE - 5.5.22
- XE Cards (5.5.26)
- GE24 Cards (5.5.27)

5.5.2 Accessing the Card Management Application

To access the Card Management application, right click on the device and select *Provision -> Card Management* (you can also select the device and select the *Operations* pull-down on the main menu items).

Figure 5-103 and Figure 5-104 show the **Card Management** window for a iMAP 9400 and iMAP 9700. Table 5-13 describes the buttons and fields that are displayed.

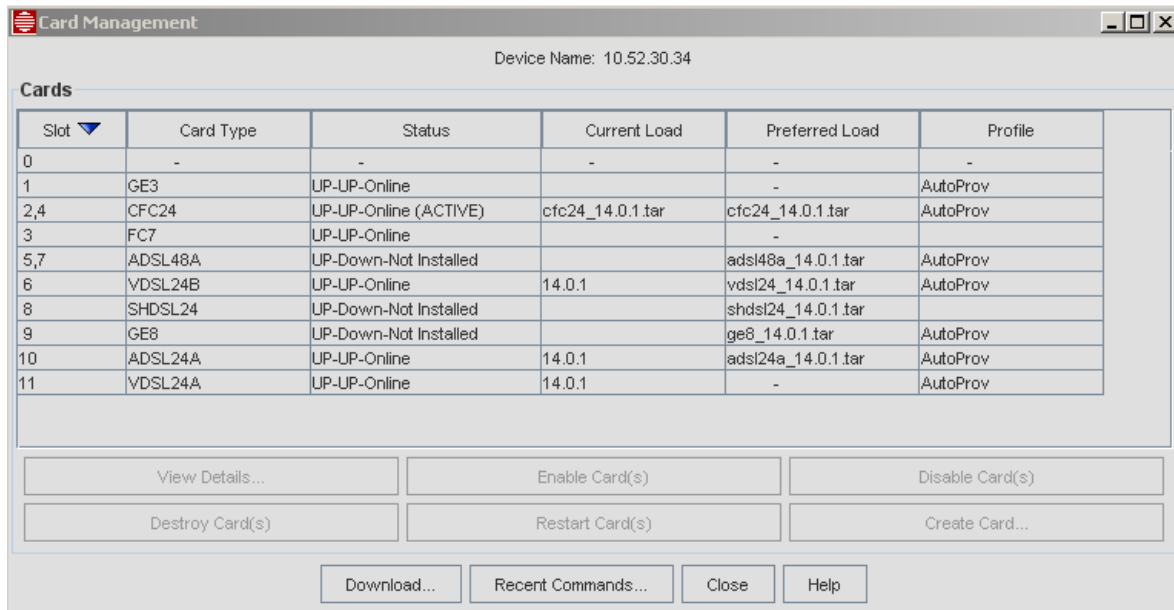

FIGURE 5-103 Card Management Window for iMAP 9400

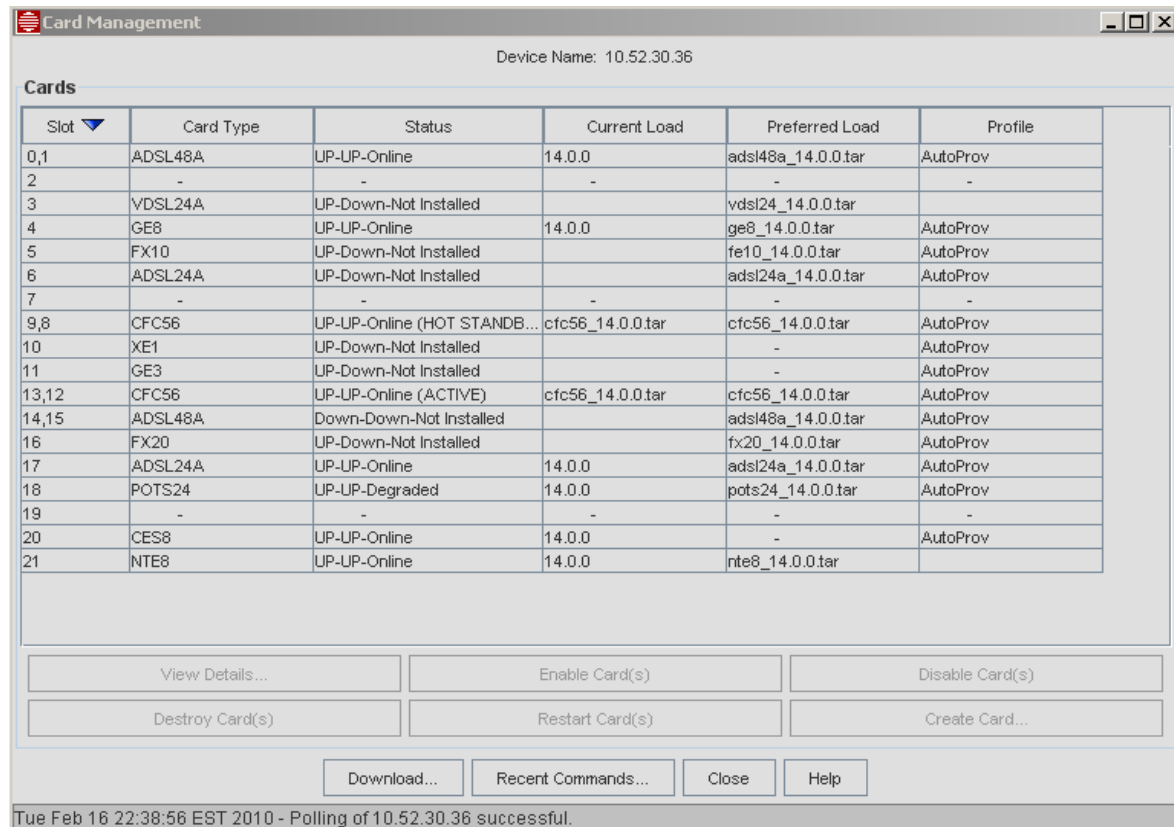

FIGURE 5-104 Card Management Window for iMAP 9700

TABLE 5-13 Card Management Application Window

Field/Button	Description
Device Name	The Name given to the device in the Managed Objects property table
Slot	The slot in the iMAP device that contains the card.
Card Type	For allowed card types refer to the <i>iMAP Component Specification</i> .
Status	Three parts: ADMIN STATE-OPERATIONAL STATE-Status. Only the ADMIN STATE can be controlled by the user. Refer to 5.5.24 .
Current Load	The load currently in FLASH memory.
Preferred Load	The primary load that the card will load from.
Profile	Whether the card is in AutoProv or Manually Provisioned mode. Refer to 5.5.24 .
View Details	Displays the current attributes of the type card. Inactive if a card has no provisioning data and the FC7. Refer to 5.5.24 .
Enable Card	Sets the card's ADMIN state to UP. Active only when card is disabled.
Disable Card	Sets the card's ADMIN state to DOWN. Active only when card is enabled or, in the case of the active CFC, is not active.
Destroy Card	Removes the card from the provisioning database. Enabled only when card has been disabled.
Restart Card	Reboots the card. Active only when the card is provisioned and physically installed.
Create Card	Provisions the card. Active when the selected slot does not currently have a provisioned card. Refer to 5.5.3 .
Download	Views the files currently on the FLASH memory of the cards and allows files to be deleted or downloaded. The available load can then be downloaded using the Download button. This button is also available on the Card Details window. Refer to 5.5.23 .

5.5.3 Creating a Card (Pre-provisioning)

Provisioning data can be created for a card regardless of whether the card is physically present. In the Card Management window, select any card that has a card type of “-” and the **Create** button will be activated. The attributes for cards can be divided into four types:

- ADSL/VDSL - This has the fields included in Table 5-14, and is the same for all other card types except those listed next.
- GE - The GE8 card has a sw load, while the GE3 does not.
- CES8 and NTE8 - This includes the field Ports Type, explained in 5.5.14 and 5.5.15.
- EPON2 - Refer to 5.5.18.

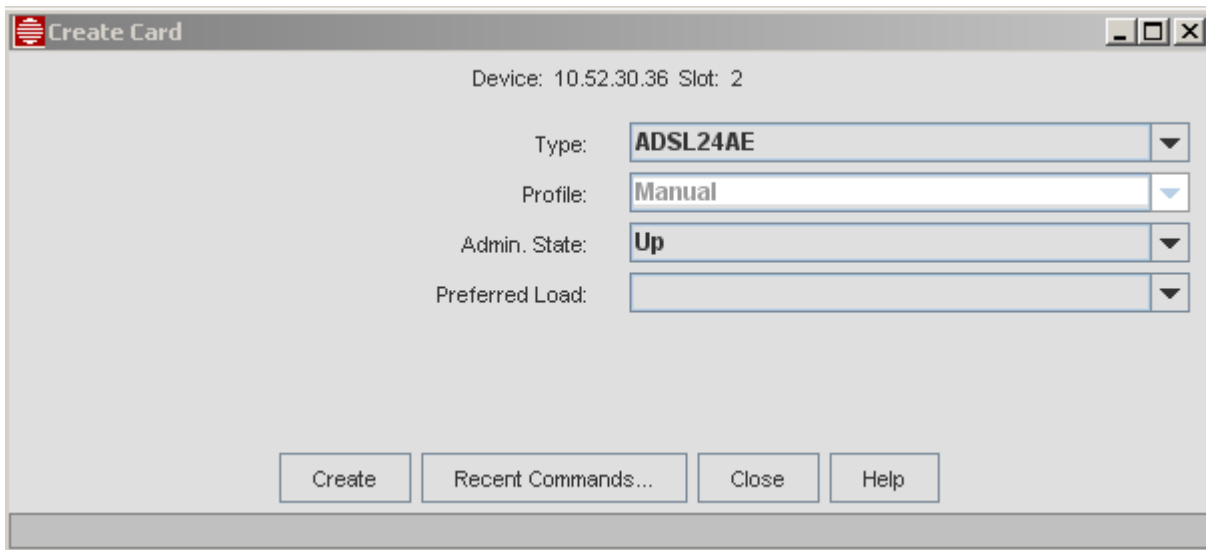

FIGURE 5-105 Create Card Window for ADSL Card

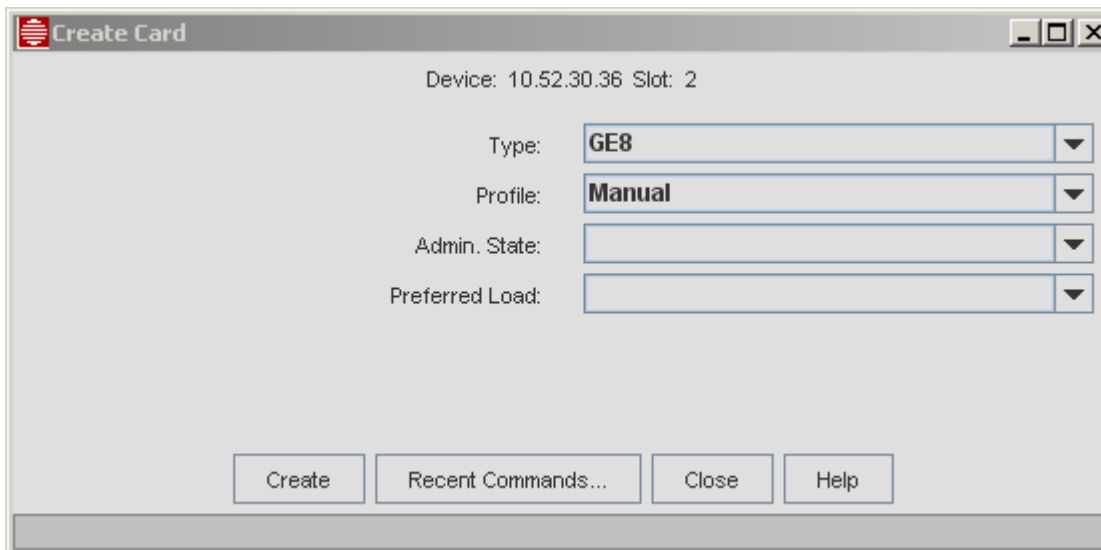

FIGURE 5-106 Create Card Window for GE8 Card

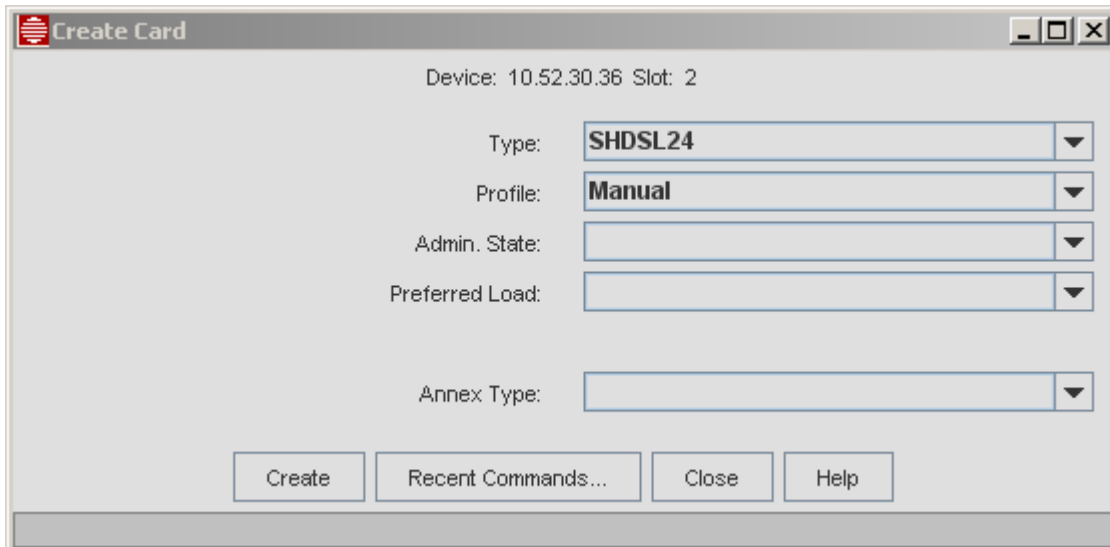

FIGURE 5-107 Create Card Window for SHDSL24 Card

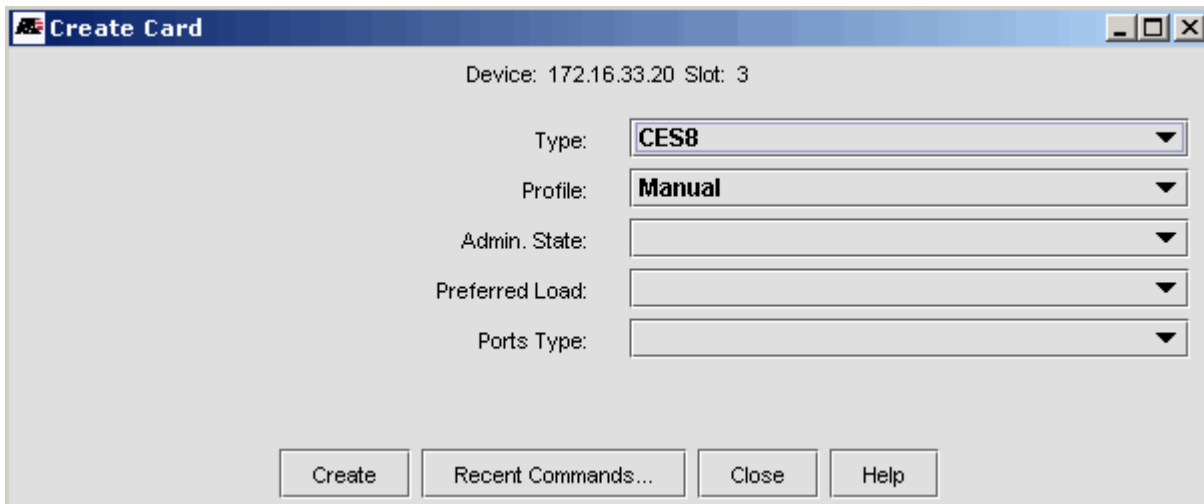

FIGURE 5-108 Create Card Window for CES8 Card

TABLE 5-14 Create Card Details

Field/Button	Description
Device	The device name and the slot number for the card.
Type	The type of card that can be provisioned in the selected slot.
Profile	The profile used to provision the card. The only selection is manual, since when a profile for a card type is set to AutoProv, the card will automatically provision itself when inserted in that slot.
Admin. State	If set to UP, the card is capable of providing service and will try to go into service (Op State to UP) once the card is created (the card is automatically enabled). If set to NO, the card will be created but disabled.

TABLE 5-14 Create Card Details

Field/Button	Description
Preferred Load	For cards that have software loads, this is the software that will load when the card restarts. In normal operation this should be the same as the running load. For the GE1 card this field does not appear. Refer to 5.5.24 .
Create	Creates the card in the provisioning data. The Card Management window will refresh and the card will come up in a state of UP-DOWN-NotInstalled. (Refer to the Status column in Table 5-13 .)
Cancel	Dismisses window.

5.5.4 GE3 Card

After selecting a GE1, the user can select *View Details*, which provides specific information on the card and includes some of the same options available on the Card Management table. Refer to [Figure 5-109](#) and [Table 5-15](#).

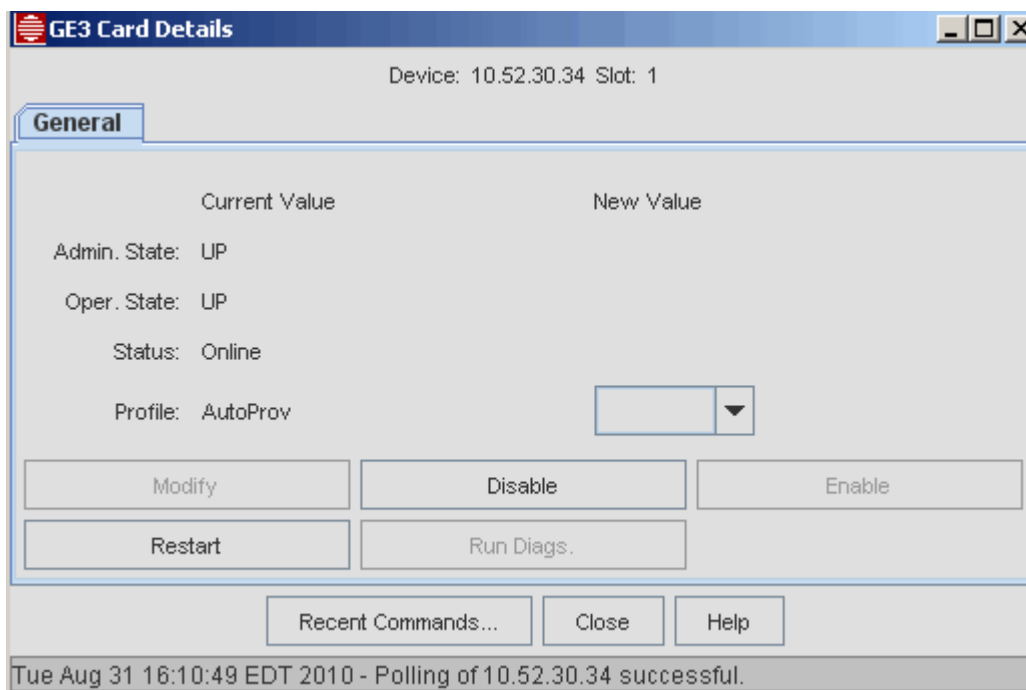

FIGURE 5-109 GE3 Card Details

TABLE 5-15 GE3 Card Details

Field/Button	Description
Device	The device name and the slot number for the card (0 or 1 for the iMAP 9400, 10 or 11 for the iMAP 7700).
Admin. State	If UP, the GE1 is capable of providing service. If DOWN, can Run Diags.
Oper. State	The GE1 is providing service. This state is not controllable but depends on the Admin. State.
Status	The current state of the card. States can be static or dynamic (transition of state such as Initializing or Running Tests).

TABLE 5-15 GE3 Card Details

Field/Button	Description
Profile	The template for provisioning data. The default is AutoProv. If the blank pull-down is chosen, there is no profile (manually provisioned).
Modify	Activated when the Profile is changed.
Disable	Disables the card. Active only when the Admin State is UP.
Enable	Enables the card. Active only when the Admin State is DOWN.
Restart	Reboots the card. For the GE1, there is no software load.
Run Diags	Runs diagnostics. Active only when the Admin state is DOWN, so must Disable first.

5.5.5 GE8 Card

The attributes and options are the same as for the GE3 card except that the GE8 has a software load, described in 5.5.4.

5.5.6 ADSL24A Card

After selecting an ADSL24 card, the user can select *View Details*, providing specific information on the card and some of the same options available on the Card Management table. Refer to Figure 5-110 and Table 5-16.

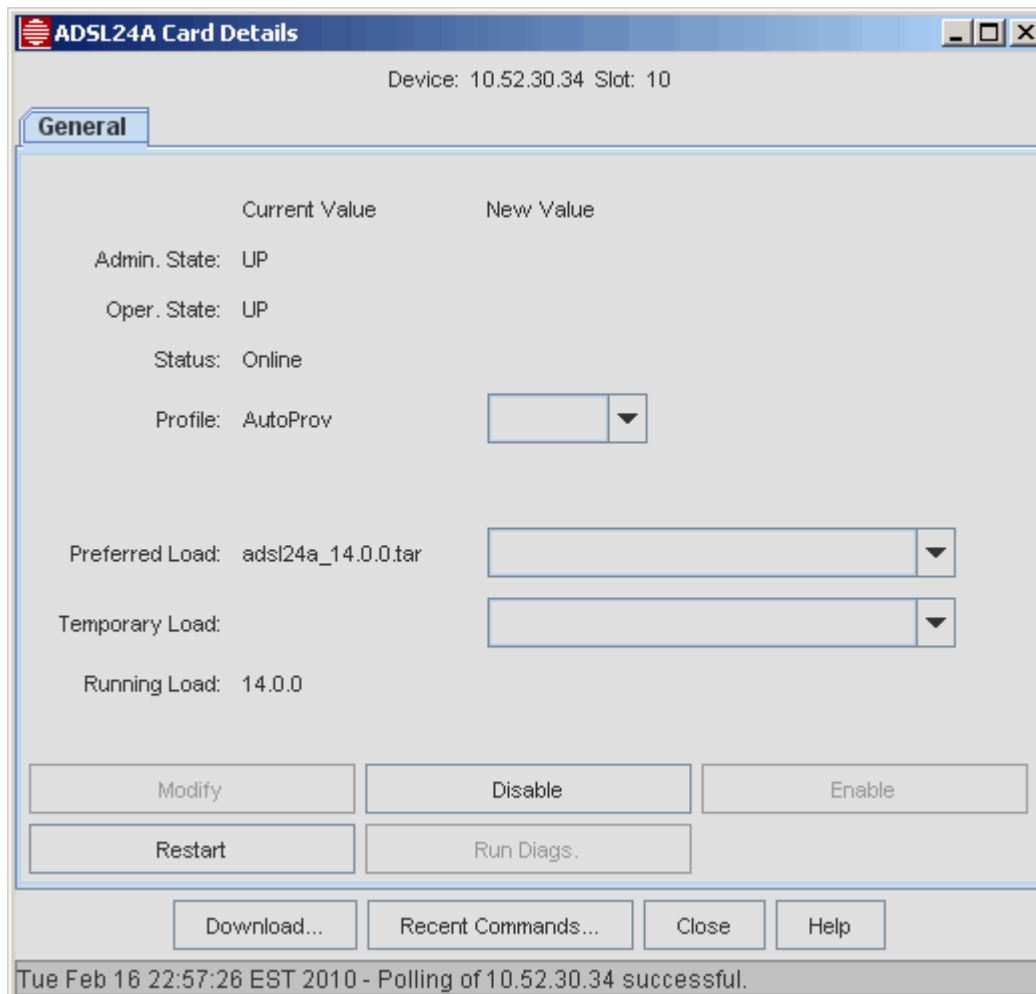

FIGURE 5-110 ADSL24A Card Details

TABLE 5-16 ADSL Card Details

Field/Button	Description
Device	The device name and the slot number for the card (5-11 for the iMAP MAP n400, 0-7, 14-21 for the iMAP MAP n700 in duplex mode).
Admin. State	If UP, the ADSL is capable of providing service. If DOWN, can Run Diags.
Oper. State	The ADSL is providing service. This state is not controllable but depends on the Admin. State.
Status	The current state of the card. States can be static or dynamic (transition of state such as Initializing or Running Tests).
Profile	The template for provisioning data. The default is AutoProv. If the blank pull-down is chosen, there is no profile (manually provisioned).
Preferred Load	This is the software that will load when the card restarts. In normal operation this should be the same as the running load. This is used during software upgrades.
Temporary Load	This is software that will load the next time the card restarts, and is part of the software upgrade process.
Running Load	The software that is currently on the FLASH of the card.
Modify	Activated when the Profile, Preferred Load, or Temporary Load is changed, is changed.
Disable	Disables the card. Active only when the Admin State is UP.
Enable	Enables the card. Active only when the Admin State is DOWN.
Restart	Reboots the card. The load used will be the Running Load unless the preferred or temporary load has been specified, such as during an upgrade.
Run Diags	Runs diagnostics. Active only when the Admin state is DOWN, so must Disable first.
Download*	Brings up the Download Software window. Refer to 5.5.23 .

5.5.7 ADSL24 (Annex B) and ADSL24AE

The ADSL24 Annex B and ADSL24AE cards have the same attributes as the ADSL24A card. Refer to 5.5.6.

Note: The NMS cannot distinguish annex A from annex B for ADSL24 cards. Users need to know which annex their cards are. When selecting a preferred load or a temporary load, the annex a file is `adsl24_.tar` and the annex b file is `adsl24xb_*.tar`.*

5.5.8 SHDSL24 Card (Card-Level vs. Port-Level)

SHDSL (Symmetric Highspeed Digital Subscriber Line) is an international standard for symmetric DSL that provides for sending and receiving high-speed symmetrical data streams over a single or dual pair of copper wires and supports Annex-B service for data and voice.

In release 8.0 and 9.0, there are the standard card fields as well as Annex Type. Prior to release 8.0, the bonding mode was set on the card. This is now controlled on a port basis.

Note: For information on port-level bonding available after 8.0 and how it affects card and port management, refer to 5.6.22

5.5.9 CFC24 Card in Simplex and Duplex

When viewing the CFC24 of a 9400 or 9700 in simplex mode, only one CFC24 is displayed when **Show Details** is selected in the **Card Management** form. Figure 5-111 shows the CFC24 Card Details window for simplex. When viewing a 9700 in duplex mode, as shown in Figure 5-112, the Card Details window includes both CFC24 and includes these fields/buttons:

- **Activity Status** - Whether the CFC24 is ACTIVE or INACTIVE

- **Swap Activity** - This button appears on the ACTIVE CFC24 window and, after confirmation by a prompt, swaps activity.

Table 5-17 lists the fields/buttons available for the CFC24 details and highlights what is unique for the duplex CFC24.

Note: For a description of what occurs during a Swap Activity of CFC24s and the conditions that would prevent this from occurring, refer to the iMAP Series User Guide.



FIGURE 5-111 CFC24 Card Details (Simplex)

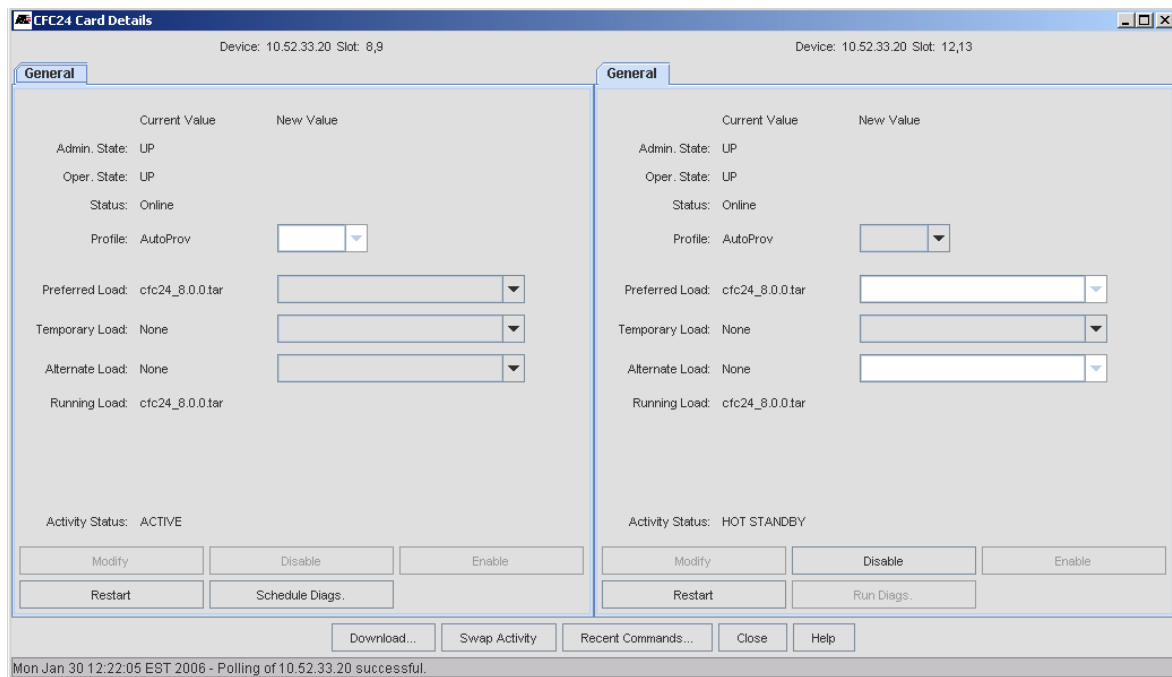

FIGURE 5-112 CFC24 Card Details (Duplex)

TABLE 5-17 CFC24 Card Details

Field/Button	Description
Device	The device name and the slot number for the card (2,4 for the iMAP n400, 8-9, 12-13 for the iMAP n700 in duplex mode).
Admin. State	If UP, the CFC24 is capable of providing service. In Duplex mode both CFCs should be UP. If DOWN, can Schedule Diags.
Oper. State	The CFC24 is providing service. This state is not controllable but depends on the Admin. State. In Duplex mode both CFCs should be UP.
Status	The current state of the card. States can be static or dynamic (transition of state such as Initializing or Running Tests). In normal operation CFC24 cards should be ONLINE for both simplex and duplex.
Profile	The profile used to provision the card. The only selection is manual, since when a profile for a card type is set to AutoProv, the card will automatically provision itself when inserted in that slot.
Preferred Load	This is the software that will load when the card restarts. In normal operation this should be the same as the running load, and includes the software that will download to the other cards. This load will be different during software upgrades.
Temporary Load	This is software that will load the next time the card restarts, and is part of the software upgrade process, so this is usually empty.
Alternate Load	An alternate load file.
Running Load	The software that is currently on the FLASH of the card. For duplex in normal operation, the loads should be the same.
Diags. Result	Shows the status and results of diagnostics set by using the Schedule Diags. button. For the iMAP 9400 and iMAP 9700 in simplex mode, these are run with the card in service. For the 7700 in duplex mode, these are run on the inactive CFC24.

TABLE 5-17 CFC24 Card Details (Continued)

Field/Button	Description
Diags Schedule	Whether the Schedule Diags. button has been used to schedule diagnostics on the active (simplex) or inactive (duplex) CFC24 card.
Modify	Activated when the Profile, Preferred Load, or Temporary Load is changed.
Disable	Disables the card. Active only when the Admin State is UP. In duplex, this cannot be done to the Active CFC24 card.
Enable	Enables the card. Active only when the Admin State is DOWN.
Restart	Reboots the card. The load used will be the Running Load unless the preferred or temporary load has been specified, such as during an upgrade.
Schedule Diags.	Schedules diagnostics. Active only when the Admin state is DOWN, so must Disable first.
Download	Brings up the Download Software window. Refer to 5.5.23 .
Swap Activity	This appears on the ACTIVE CFC24 card only, and, after confirming, swaps activity between the CFC6s.

5.5.10 CFC56, CFC100, and CFC200 Card

The iMAP 9000 series products also support the CFC56 and CFC100 (iMAP 9810) as well as the CFC200 (SBx3112). These cards have similar attributes as the CFC24 card, explained in 5.5.9.

5.5.11 FE10/FX10 Card

Figure 5-113 and Table 5-18 lists the fields/buttons available for the FE10 card.

The screenshot shows a window titled "FX10 Card Details" with a standard Windows-style title bar. The main content area is divided into two columns: "Current Value" and "New Value".

Device: 10.52.30.36 Slot: 5

General

Field	Current Value	New Value
Admin. State:	UP	
Oper. State:	Down	
Status:	Not Installed	
Profile:	AutoProv	[Dropdown]
Preferred Load:	fe10_14.0.1.tar	[Dropdown]
Temporary Load:		[Dropdown]
Running Load:		

Buttons: Modify, Disable, Enable, Restart, Run Diags., Download..., Recent Commands..., Close, Help

Footer: Mon Sep 20 14:18:47 EDT 2010 - Polling of 10.52.30.36 successful.

FIGURE 5-113 FE10/FX10 Card Details

TABLE 5-18 FE10/FX10 Card Details

Field/Button	Description
Device	The device name and the slot number for the card.
Admin. State	If UP, the FE10 is capable of providing service. If DOWN, can Run Diags.
Oper. State	The FE10 is providing service. This state is not controllable but depends on the Admin. State.
Status	The current state of the card. States can be static or dynamic (transition of state such as Initializing or Running Tests).
Profile	The template for provisioning data. The default is AutoProv. If the blank pull-down is chosen, there is no profile (manually provisioned).
Preferred Load	This is the software that will load when the card restarts. In normal operation this should be the same as the running load. This is used during software upgrades.
Temporary Load	This is software that will load the next time the card restarts, and is part of the software upgrade process.
Running Load	The software that is currently on the FLASH of the card.

TABLE 5-18 FE10/FX10 Card Details

Field/Button	Description
Modify	Activated when the Profile is changed.
Disable	Disables the card. Active only when the Admin State is UP.
Enable	Enables the card. Active only when the Admin State is DOWN.
Restart	Reboots the card. For the FE10, there is no software load.
Run Diags	Runs diagnostics. Active only when the Admin state is DOWN, so must Disable first.

5.5.12 FX20 Card

The FX10/FX20 Card Details form is similar to the FE10, shown in Figure 5-113.

5.5.13 POTS24 Card

The iMAP POTS24/POTS24C card (referred to forward as POTS24) is a single slot service module that provides 24 analog loopstart line circuits on the iMAP 9000 system. The POTS24 card supports VoIP using:

- MGCP (Media Gateway Control Protocol)
- Session Initiated Protocol (SIP)

The RTP (Real-Time Protocol, RFC 3550) configuration specifies how the card will exchange bearer packets with the call agent over the network. Once the IP provisioning is done for the card's virtual Ethernet interface, the RTP attributes can be provisioned.

Note: The POTS24 must have IP, MGCP/SIP, and RTP protocol attributes provisioned in association with the card in order to provide service. Therefore, the POTS24 card cannot be completely auto-provisioned to an in-service state; some manual configuration is required for each card that cannot be specified in the auto-provisioning profiles. For a full explanation of these attributes, refer to the section on provisioning POTS in the iMAP User Guide.

Note: Any modification of RTP parameters requires the card to be disabled

Note: In release 9.0, there are separate software loads for the POTS24 card, one for supporting MGCP and another for supporting SIP. Therefore, one card can only support one type of protocol or the other.

Figure 5-115 shows the POTS24 Card Create Form which shows the protocol choice, while subsequent figures show the POTS24 Card Details Form and how they display MGCP or SIP attributes. Note that the IP/RTP subtab of the Protocols tab has the same values regardless of whether MGCP or SIP is configured.

Device: 10.52.30.36 Slot: 15

Type: POTS24

Profile: Manual

Admin. State:

Preferred Load:

POTS Protocol: SIP

Buttons: Create, Recent Commands..., Close, Help

FIGURE 5-114 Create POTS 24 Card Form

Device: 10.52.30.35 Slot: 8

General | Protocols | Statistics | Graph Stats

Current Value	New Value
Admin. State: UP	
Oper. State: Down	
Status: Failed	
Profile: AutoProv	
POTS Protocol: SIP	
Preferred Load: pots24s_9.0.0.tar	
Temporary Load:	
Running Load:	

Buttons: Modify, Disable, Enable, Restart, Run Diags., Download..., Recent Commands..., Close, Help

FIGURE 5-115 Card Management - POTS24 - General Tab

5.5.13.1 POTS24 Card - General Tab

TABLE 5-19 POTS24 Card Details - General Tab

Field/Button	Description
Device	The device name and the slot number for the card.
Admin. State	If UP, the POTS24 is capable of providing service. If DOWN, can Run Diags.
Oper. State	The POTS24 is providing service. This state is not controllable but depends on the Admin. State.
Status	The current state of the card. States can be static or dynamic (transition of state such as Initializing or Running Tests).
Profile	The template for provisioning data. <i>Note: The profile is Manually Provisioned. Refer to the above Note.</i>
POTS Protocol	Whether the card is using MGCP or SIP. <i>Note: If the card is enabled, this pull-down is not available.</i>
Preferred Load	This is the software that will load when the card restarts. In normal operation this should be the same as the running load, and includes the software that will download to the POTS24 card. This load will be different during software upgrades. <i>Note: Loads that support SIP have the label POTS24S (versus POTS24).</i>
Temporary Load	This is software that will load the next time the card restarts, and is part of the software upgrade process, so this is usually empty.
Running Load	An alternate load file.
Modify	Activated when the Profile is changed.
Disable	Disables the card. Active only when the Admin State is UP.
Enable	Enables the card. Active only when the Admin State is DOWN.
Restart	Reboots the card. If there is a Temporary Load, this will be loaded onto the card.
Run Diags	Runs diagnostics. Active only when the Admin state is DOWN, so must Disable first.
Download	Brings up the Download Software window. Refer to 5.5.23.

5.5.13.2 POTS24 Card - Protocols/IP/RTP Tab

TABLE 5-20 POTS24 Card Details - Protocols Tab for IP/RTP

Field/Button	Description
IP	
VLAN vid (2..4094):	Specification of the interface in terms of VLAN id. A logical representation of a port. An id must be a VID number
IP Address	IP address of the interface.
Subnet Mask	Subnet mask of the interface.
Gateway	Optional gateway address for the interface.
DNS Server	Domain name server (DNS) for the card. Use only when the MGCP Call Agent is a DNS host name.

TABLE 5-20 POTS24 Card Details - Protocols Tab for IP/RTP

Field/Button	Description
Domain Name	Optional domain name for the interface.
RTP	
DSCP Settings	The DSCP (Differentiated Services Code Point, RFC 2474) value for RTP packets transmitted from the POTS24 card. The default value is 46 .
VLAN P bits (0..7)	The 802.1p priority bit setting for RTP packets transmitted from the POTS24 card. The default value is 6 .
Modify	Activated when a value has been changed. When selected, makes the changes to the card.
Clear Entry Fields	Clears all changed values
Download	Brings up the Download Software window. Refer to 5.5.23 .

5.5.13.3 POTS24 Card - Protocols - MGCP Tab

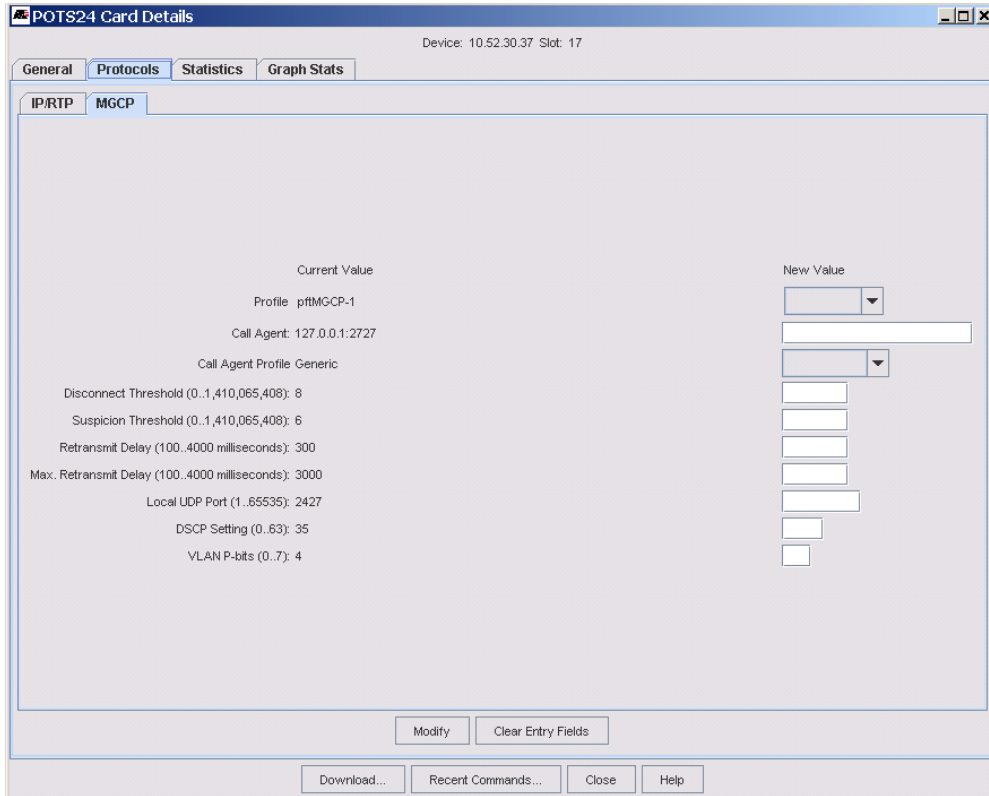

FIGURE 5-116 POTS24 Card - Protocols/MGCP Tab

TABLE 5-21 POTS24 Card Details - Protocols Tab for MGCP

Field/Button	Description
Profile	The profile that has been applied to the card
Call Agent (or None)	The IP address of the network call agent that the card will communicate with.
Call Agent Profile	
Disconnect Threshold	Also known as Max2 in RFC 3435, this is the number of unacknowledged packet retransmissions towards the call agent before beginning a disconnect procedure if there are no other call agent addresses available. Once this threshold is exceeded, the POTS24 card will be in the FAILED state. The default value is 7.
Suspicion Threshold	Also known as Max1 in RFC 3435, this is the number of unacknowledged packet retransmissions toward the call agent that are allowed before suspecting that the call agent is unreachable, which triggers the MGCP application running in the POTS24 card to use alternate addresses for the agent or initiate a new DNS query to verify the call agent address. The default value is 5.
Retransmit Delay (100..4000 ms)	The initial delay before any packet retransmission is done towards the call server. The default value is 200 milliseconds .

TABLE 5-21 POTS24 Card Details - Protocols Tab for MGCP (Continued)

Field/Button	Description
Max. Retransmit Delay (100..4000 ms)	Also known as RTO-MAX in RFC 3435, this is the maximum amount of time to wait for an acknowledgement from the call agent before retransmitting a packet. The default value is 4000 milliseconds .
UDP Port	Specifies the UDP (User Datagram Protocol) port the MGCP application in the POTS24 card will use for receiving packets. The default value is 2427 .
DSCP Settings (0..63)	The DSCP (Differentiated Services Code Point, RFC 2474) value for MGCP packets transmitted from the POTS24 card The default value is 34 .
VLAN P bits (0..7)	The 802.1p priority bit setting for MGCP packets transmitted from the POTS24 card. The default value is 5 .
Modify	Activated when a value has been changed. When selected, makes the changes to the card.
Clear Entry Fields	Clears all changed values
Download	Brings up the Download Software window. Refer to 5.5.23 .

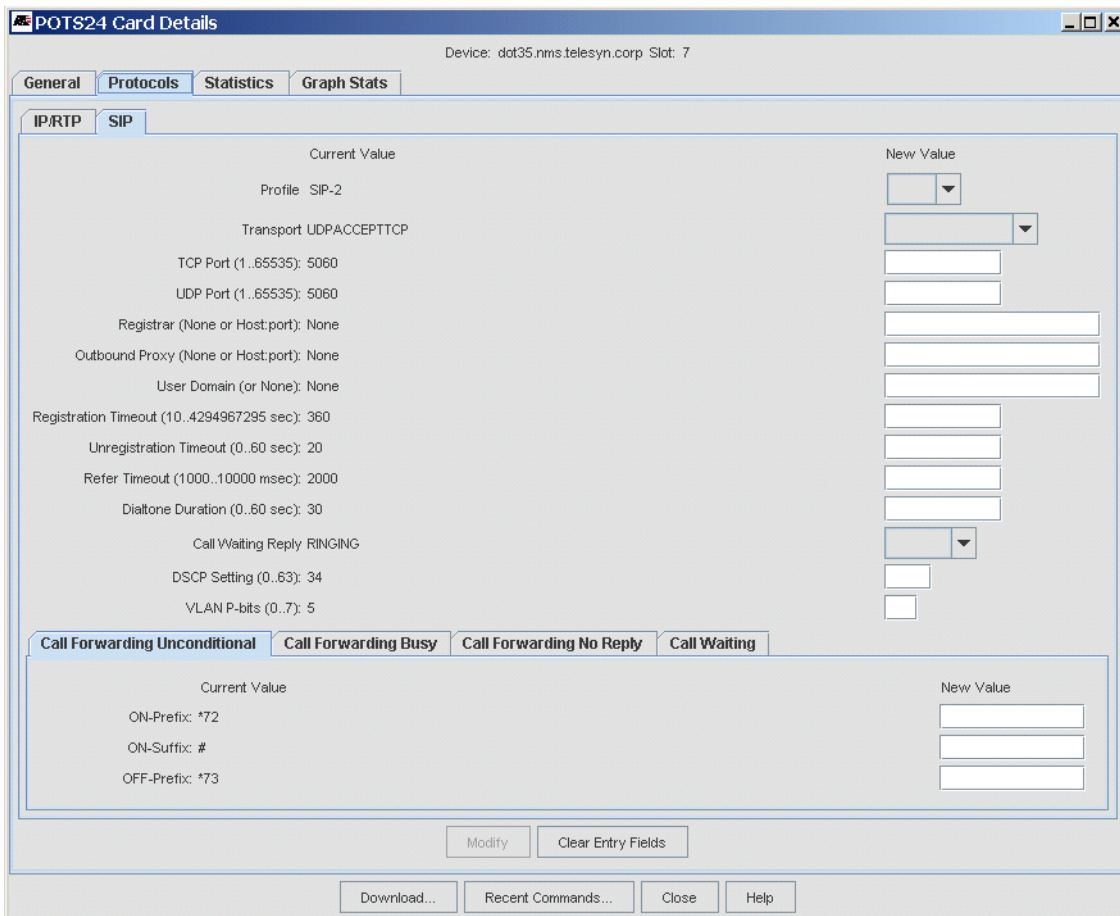

FIGURE 5-117 POTS24 Card - Protocols/SIP Tab

TABLE 5-22 POTS24 SIP Attributes - (Defaults are in Bold)

POTS24 Card Attribute	Description
Profile	The Profile that has been applied to the card
Transport	The Transport type of the outgoing messages. When set to <i>UDP Accept TCP</i> , the IP Phone will accept incoming TCP messages. (TCP)
TCP Port	The TCP port on which the Stack listens. (5060)
UDP Port	The UDP port on which the Stack listens (5060)
Registrar (Host port)	The Registrar IP address or domain name. If this parameter is not set, Registration messages will not be sent. NULL (The number of the Port on which the Registrar listens)
Outbound Proxy (Host Port)	The IP address of the outbound Proxy. If this parameter is set, all outgoing messages (including Registration messages) will be sent to this Proxy. The outboundProxyHostName can be used for setting the IP address or the DNS name that the call application can parse NULL (The number of the Port on which the outbound Proxy listens)
User Domain	This domain name will be sent in the From header of outgoing Invite messages
Registration Time-out	The time-out (in seconds) for sending Proxy Re-registration requests 3600
Unregistration Time-out	This parameter is relevant for unregistration requests that are sent as part of the IP Phone Toolkit shutdown process. The time-out (in seconds) indicates the time interval to wait for a reply after sending an unregister request before completing the shutdown process. If the time-out expires before a reply has been received, the shutdown process will be completed. If a reply is received before the time-out expires, the IP Phone Toolkit will respond accordingly and then complete the shutdown process. 20
Refer Time-out	The time-out (in milliseconds) for waiting for Notify after sending Refer, before disconnecting the call-leg 2000
Dialtone Duration	Duration of Dial Tone signal (in milliseconds) when going off-hook. When the subscriber goes off-hook and time-out expires, Dial Tone will be stopped and the connection will disconnect. 0 indicates an infinite Dial Tone. 3000
Call Waiting Reply	When the incoming call is a Call Waiting call, this parameter indicates which SIP message will be sent as a reply to the Invite.
DSCP Settings (0..63)	The DSCP (Differentiated Services Code Point, RFC 2474) value for SIP packets transmitted from the POTS24 card. 34
VLAN P bits (0..7)	The 802.1p priority bit setting for SIP packets transmitted from the POTS24 card. 5
Call Forwarding Unconditional Sub-tab ON-Prefix ON-Suffix OFF-Prefix	After CFW Unconditional has been activated, incoming calls are forwarded independently of the status of the endpoint.

TABLE 5-22 POTS24 SIP Attributes - (Defaults are in Bold) (Continued)

POTS24 Card Attribute	Description
Call Forwarding Busy Sub-tab ON-Prefix ON-Suffix OFF-Prefix	After CFW Busy has been activated, incoming calls are forwarded only if the endpoint is busy, i.e., all lines are active.
Call Forwarding Busy Sub-tab ON-Prefix ON-Suffix OFF-Prefix	After CFW No Reply has been activated, incoming calls are forwarded only if the endpoint does not answer before a pre-configured time-out.

5.5.13.4 POTS 24 Statistics Tab

TABLE 5-23 POTS24 Card Details - Statistics Tab for MGCP

Field/Button	Description
MGCP Statistics	<p>Statistics supported for the MGCP application running on the POTS24 card are defined in the ATN SNMP Enterprise MIB.</p> <p>SentMessages: The total number of messages sent. This includes both commands and responses.</p> <p>RcvdMessages: The total number of messages received. This includes both commands and responses.</p> <p>LostMessages: The number of command messages for which responses were not received.</p> <p>CmdsRetransmitted: The number of commands that had to be retransmitted.</p> <p>RcvdBadVersionMessages: The number of messages received that were discarded due to the presence of an unsupported MGCP version number in the message.</p> <p>UnrecognizedMessages: The number of messages received that were discarded because they were unrecognizable as MGCP messages.</p>
Interface Statistics	These are the statistics from the Interface MIB. Refer to the MAP User Guide.
RMON Statistics	These are the standard Ethernet-based statistics
Name	Defined in the High Capacity RMON MIB (RFC3273 - etherStatsHighCapacityTable)
High Capacity Counts	Name of high capacity counts, for example 63 Octet packets is the total number of packets (including bad packets) received that were 64 octets in length (excluding framing bits but including FCS octets).
Overflow	The number of times the associated counter has overflowed. In iMAP MAP 4.1 these should always be 0.
Reset MGCP Statistics	Resets the MGCP statistics to 0.
Enable RMON Statistics	Activated when the RMON statistics are disabled.
Disable RMON Statistics	Activated when the RMON statistics are enabled.
Reset RMON Statistics	Resets the RMON statistics to 0.
Download	Brings up the Download Software window. Refer to 5.5.23 .

TABLE 5-24 POTS24 Card Details - Statistics Tab for SIP

Field/Button	Description
SIP Statistics	<p>Statistics supported for the SIP application running on the POTS24 card are defined in the ATN SNMP Enterprise MIB.</p> <p>Invites Received / Retransmitted: The total number of invite messages received and retransmitted.</p> <p>Non-Invites Received / Retransmitted: The total number of non-invite messages sent and retransmitted.</p> <p>Responses Received / Retransmitted: The number of responses messages received and retransmitted.</p> <p>Invites Sent / Invite Retransmits Sent: The total number of invite messages sent and retransmitted.</p> <p>Non-Invites Sent / Non-Invite Retransmits Sent: The total number of non-invite messages sent and retransmitted.</p> <p>Responses Sent / Responses Retransmit Sent: The number of responses and retransmitted Responses sent</p>
Interface Statistics	These are the statistics from the Interface MIB. Refer to the iMAP User Guide.
RMON Statistics	These are the standard Ethernet-based statistics
Name	Defined in the High Capacity RMON MIB (RFC3273 - etherStatsHighCapacityTable)
High Capacity Counts	Name of high capacity counts, for example 63 Octet packets is the total number of packets (including bad packets) received that were 64 octets in length (excluding framing bits but including FCS octets).
Overflow	The number of times the associated counter has overflowed. These should be 0.
Reset SIP Statistics	Resets the SIP statistics to 0.
Enable RMON Statistics	Activated when the RMON statistics are disabled.
Disable RMON Statistics	Activated when the RMON statistics are enabled.
Reset RMON Statistics	Resets the RMON statistics to 0.
Download	Brings up the Download Software window. Refer to 5.5.23 .

5.5.13.5 POTS 24 Graph Stats Tab

This is the standard window that allows the user to display the Interface MGCP/SIP, and RMON statistics.

5.5.14 CES8 Card

The CES8 card provides “Pass-thru” Circuit Emulation Service for both E1 and DS1 circuits.

Note: The user provisions DS1 or E1 attribute, called the PORTTYPE, at the card level. E1 and DS1 ports cannot be provisioned on the same card. Moreover, to modify the PORTTYPE, the user must DISABLE the card. Changing the PORTTYPE effectively destroys the card and creates a new card with the new port types.

	Current Value	New Value
Admin. State:	UP	
Oper. State:	UP	
Status:	Online	
Profile:	AutoProv	<input type="text"/>
Preferred Load:	ces8_14.0.1.tar	<input type="text"/>
Temporary Load:		<input type="text"/>
Running Load:	14.0.1	
Ports Type:	CES-DS1	<input type="text"/>
Timing Ref:	Internal	<input type="text"/>

Buttons: Modify, Disable, Enable, Restart, Run Diags., Download..., Recent Commands..., Close, Help

FIGURE 5-118 CES8 Card Details

All the fields for the General tab are the same as for other cards except for the following:

- **Port Type** - This can be DS1 (the default) or E1. Note that the card must be disabled before the Port Type can be changed.
- **Timing Ref.** - The timing reference is where the card will get its clocking reference from. The choices are:
 - INTERNAL - The internal oscillator (locked to a timing signal from the active CFC)
 - A “self-timed” DS1/E1 port physical interface
 - A “self-timed” Pseudo-span (using RTP-based derived, adaptive timing)

The buttons for the CES8 card are similar to other cards, while noting the following:

- **Restart** - Needed when a different load is being used.
- **Run Diags.** - Runs a set of diagnostics. The card must be disabled first. If there are failures, there are messages and logs that can be accessed using the Log Manager.

	Current Value	New Value
VLAN (1..4094):	549	<input type="text"/>
IP Address:	10.20.30.90	<input type="text"/>
Subnet Mask:	255.255.255.128	<input type="text"/>
Gateway (None or IP Address):	-	<input type="text"/>
DNS (None or IP Address):	-	<input type="text"/>
Domain Name (or None):	-	<input type="text"/>

FIGURE 5-119 CES8 Card Details- Protocols Tab

The Protocols tab is used to fill in the interface attributes of the DS1 card. The only required fields are the VLAN, IP Address, and Subnet mask values, and these must have valid entries or a Set Card Failed window appears.

Note: An IP Interface is required before any DS1/E1 ports can be provisioned for CES.

For details on these fields, refer to the *iMAP User Guide*. For information on how the CES8 card configuration is datafilled by the NMS, refer to 6.16.

5.5.15 NTE8 Card

The NTE8 card is a card release in 7.0, and can be contrasted with the CES8; while the CES8 extends the DS1/E1 network over ethernet facilities, the NTE extends the ethernet network over DS1/E1 facilities.

Note: The user provisions DS1 or E1 attribute, called the *PORTTYPE*, at the card level. In release 5.0, E1 and DS1 ports cannot be provisioned on the same card. Moreover, to modify the *PORTTYPE*, the user must *DISABLE* the card. Changing the *PORTTYPE* effectively destroys the card and creates a new card with the new port types.

All the fields for the General tab are the same as for other cards except for the following:

- **Port Type** - This can be DS1 (the default) or E1. Note that the card must be disabled before the Port Type can be changed.
- **Timing Ref.** - The timing reference is where the card will get its clocking reference from. The choices are:
 - INTERNAL - The internal oscillator (locked to a timing signal from the active CFC)
 - A “self-timed” DS1/E1 port physical interface

The buttons for the NTE8 card are similar to other cards, while noting the following:

- **Restart** - Needed when a different load is being used.

- **Run Diags.** - Runs a set of diagnostics. The card must be disabled first. If there are failures, there are messages and logs that can be accessed using the Log Manager.

5.5.16 ADSL24A, ADSL24B, and ADSL24E Card

The ADSL24A can be deployed for Annex-A and Annex-B. The ADSL24AE card is available in iMAP release 14.0. Refer to the *iMAP Component Specification* for details on the card, and the *Allied Telesis Feature Guide* for details on provisioning. Otherwise the provisioning GUIs are similar.

5.5.17 PAC24A, PAC24C Card

The PAC24A and PAC24C cards have the functionality of the ADSL24A card and the POTS24 card onto one card. (For the POTS function, splitters are included.) However, from the provisioning viewpoint, these are still treated as separate cards and so the provisioning GUIs do not change.

Note: The one area where provisioning is combined on the two cards is when the card is provisioned on the Customer Triple Play form; if the user configures the ADSL part, the POTS part is automatically filled in where applicable. Refer to 6.15.2.

5.5.18 EPON2 Card

The AlliedView NMS can be used to configure the Gigabit Ethernet EPON2 card and its connected iMG646 ONU.

Note: Refer to Section 7 for details on this type of iMG and how it contains the ONU. Refer to Section 6 about the ONU-to-iMAP EPON interface and how QoS policies (called Service Level Agreements or SLAs) are set in both the transmit and receive direction.

Each EPON2 card has 2 epon interfaces (epon:s.0 and epon:s.1, where s is the card slot number), that can connect with up to 32 ONUs, for a total of 64 ONUs per card. The ONU interfaces are identified as onu:<slot>.<port>.<onuId>, and are thought of as residing on the iMAP, even though they are physically on the ONU device.

Note: Refer to Section 5.2 on how ONUs are displayed in the Chassis View and 5.6.24 for how provisioning the ONU is incorporated into EPON2 provisioning.

Provisioning an EPON2 card is similar to provisioning other cards. Select a 9000 iMAP device, and bring up the Card Management window. Select an unprovisioned card slot and click on Create.

5.5.19 VDSL24 Card

Very high data rate digital subscriber line (VDSL) is a next-generation of high-speed DSL technology that allows faster data rates than the iMAP 9000 ADSL SMs.

The two cards that support VDSL are the VDSL24-A and VDSL24-B, with the following attributes:

- The cards have the **same** software load but support ADSL annex A and annex B by card type.
- Each port can operate in VDSL mode or ADSL annex-A/annex-B mode.

5.5.20 ADSL48A/B Card

The ADSL is a double-width card and so there are restrictions on where it can be installed (refer to the iMAP Component specification for details). The form for creating the card is standard, and when the card is created the Card Management table shows which two slots the card occupies.

5.5.21 Viewing Card Details for the iMAP 9100

The card details form is the same as for other iMAP devices with the following exceptions:

The CFC12 card is always in simplex mode and therefore cannot be enabled, disabled, or destroyed, unless the user wishes to drop service, usually during an upgrade.

Note: For more information on provisioning the iMAP 9100, refer to the iMAP User Guide.

5.5.22 GE24POE

The GE24POE card is unique to the SBx3112, and can be loaded in any slot in the SBx3112 chassis except for the CFC200 slots. Refer to 5.5.25.

5.5.23 Controlling Card Software (Download and Restart)

The **Card Details** window includes a Download button that brings up the Download software window. This window displays the current files (and their size) on the FLASH of the card, the available space, and the available loads. Figure 5-120 shows this window and Table 5-25 shows the fields/options available.

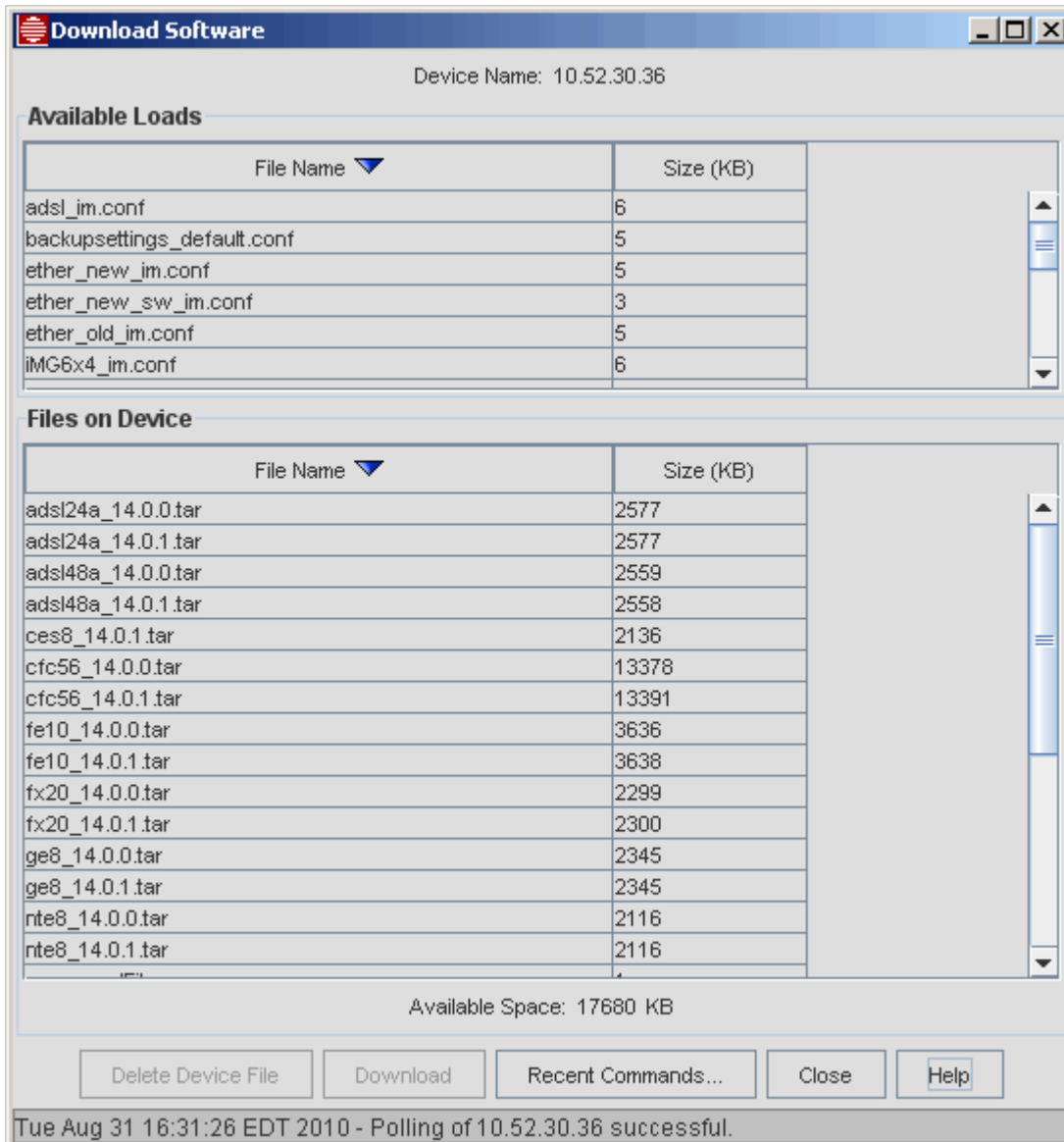

FIGURE 5-120 Download Software Window

Caution: For the devices that will receive downloads, do not set their telnet idle session time-out to any value less than 6 minutes. This minimum is needed to ensure the NMS is aware the download is complete and can proceed with any further steps.

TABLE 5-25 Download Software Window Fields/Buttons

Field/Button	Description
Available Loads	<p>This panel lists the loads available and their size. Selecting a load activates the Download button to allow a file to be downloaded. Once a file is downloaded, the user returns to the Card Details window and presses the Restart button to reboot the card and make the downloaded file the current load.</p> <p><i>Note:</i> Before downloading a file, ensure there is enough space on the card to accept the new load. Otherwise an error message will appear. Also, the user must have the Preferred Load or (usually for upgrade) Temporary load set on the card to make the card load with the desired load file.</p> <p>Controlling files requires a knowledge of how software loads are controlled on the CFC and Service Module (SM) cards. In most cases the SM loads are on the CFC cards, and when the CFC restarts the SM loads are downloaded to the SM cards. Refer to the iMAP Series User Guide for more details.</p> <p><i>Note:</i> The NMS cannot distinguish annex A from annex B for ADSL24 cards (It can distinguish between them for ADSL16 however and it doesn't need to for other card types). Users need to know which annex their cards are. (Files have to be downloaded before they will appear in the preferred load and temporary load picklists.) The annex a file is <code>adsl24_*.tar</code> and the annex b file is <code>adsl24xb_*.tar</code>.</p>
Files on Device	<p>This panel lists the files currently on the device and their size. Below this list is the space still available in FLASH memory. Clicking on a file activates the Delete Device File button and, after a confirmation, deletes the file from the FLASH memory.</p>
Delete Device File	<p>This deletes a file that has been highlighted in the Files on Device panel.</p> <p>Deleting a file from FLASH requires knowledge of the status of files (Preferred, Temporary), and must be coordinated with the Details window to ensure the correct load is used when the card restarts.</p>
Download	<p>This downloads a file that has been highlighted in the Available Loads panel.</p>

5.5.24 Overview of Provisioning Data, Profiles, and Card States

Provisioning of cards/ports means to add, modify or delete the card and port information stored on the iMAP devices and to add or remove the physical cards. Provisioning these cards involves the following:

- **Provisioning Data** - The provisioning data itself consists of:
 - States - These determine whether the card or port can be placed in service and if so whether it can process data.
 - Attributes - These are the characteristics of the card or port, usually to optimize the processing of data.
- **Persistence** - This is the ability of the provisioning data to survive changes such as a reboot of the shelf or the removal of a card.
- **Pre-provisioning** - The user has the option of creating a card and having it in the database prior to inserting the card.

Controlling these is done through the use of profiles, operational states, and provisioning modes.

In **Manual Provisioning Mode**, provisioning data must be explicitly created and modified. The data is persistent over reboots and restarts of the device and the removal of the card.

It is important to note that insertion of a card when in the **Manual Provisioning Mode** does **not** create/provision the card in the database; this must be done using the **Create Card** button.

In **Automatic Provisioning Mode**, when hardware is discovered in a slot where there is no prior provisioning, the cards and ports are automatically provisioned. This discovery occurs when:

- The card is inserted into a slot
- The card is already inserted and the device reboots
- The system mode is changed from manual to automatic

Note: The default mode for the iMAP devices is Automatic Provisioning Mode, and the mode can be changed through the Card Details screen.

A **profile** is a template that contains the provisioning data. There is one only one profile, called AUTOPROV (for Auto-provisioning), which contains at first the factory defaults, but any or all attributes can be changed. This is the profile used for the Auto Provisioning Mode.

When the system is first initialized, the system's PROVMODE is set to AUTO. Profiles can then be created, viewed, and set.

Note: Modification of a profile does not change the attributes of a card/port that has already been provisioned.

Administrative and Operational States determine whether the card or port is available for service and if so whether service is being provided;

- The **Administrative State** is controlled by the user and can be set to either UP (available for service) or DOWN (Not available for service). Control of this state is through the **Create Card** window.
- The **Operational State** is either UP (providing service) or DOWN (not providing service). This state is not user controllable but does depend on the Administrative State:
 - If the Administrative State of a card is UP, the Operational State will be UP if the card/port can provide service.
 - If the Administrative State is DOWN, the Operational State will always be DOWN.

Note: The one exception to these rules is the FC7 and FM7, which are always in an operational state of UP.

5.5.25 Power Over Ethernet (POE) Management on SBx3112

To monitor the actual power usage of the POE cards on the SBx3112, there is a menu item in the physical device pull-down, as shown in the following figure.

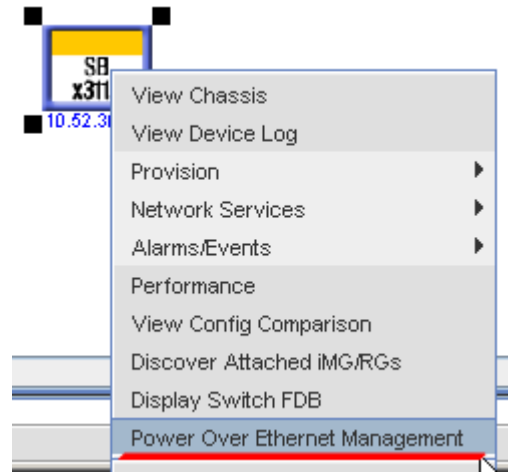

FIGURE 5-121 SBx3112 Pull-down for POE Management

This will launch a separate NMS window that will show the overall power settings for the shelf. This window will show each POE card and how much power is allocated to it, requested by it, and the actual usage. In this way the customer can manage the power distribution across the cards. Refer to the following figure.

 A screenshot of the 'Power Over Ethernet Management' window. The window is divided into several sections:

- Device:** Name: 10.52.30.44, IP: 10.52.30.44, Type: SBx3112.
- Shelf Power Status:**

	Current	New
Total	1200W	
Requested	60W	
Available	1140W	
Usage	50W	
Threshold (1..99)%	77%	
- Card Power Status:**

Card Slot ▲	Allocated	Requested	Actual	Min Voltage	Max Voltage
1	0W	0W	0W	0.0V	0.0V
3	500W	0W	0W	50.0V	57.0V
7	0W	0W	0W	0.0V	0.0V
11	500W	60W	50W	50.0V	57.0V

 At the bottom of the window, there are buttons for 'Show Ports Data', 'Hide Ports Data', 'Modify', 'Recent Commands...', 'Close', and 'Help'.

FIGURE 5-122 Power Over Ethernet Management Form - Cards

Note: The Shelf Threshold for the shelf can only be set from Power Over Ethernet Management Form.

By selecting one/multiple cards and selecting **Show Ports Data**, the user can display all of the port -specific information for the card(s) that are selected. This will show the customer the way in which power is distributed among the ports. Refer to the following figure.

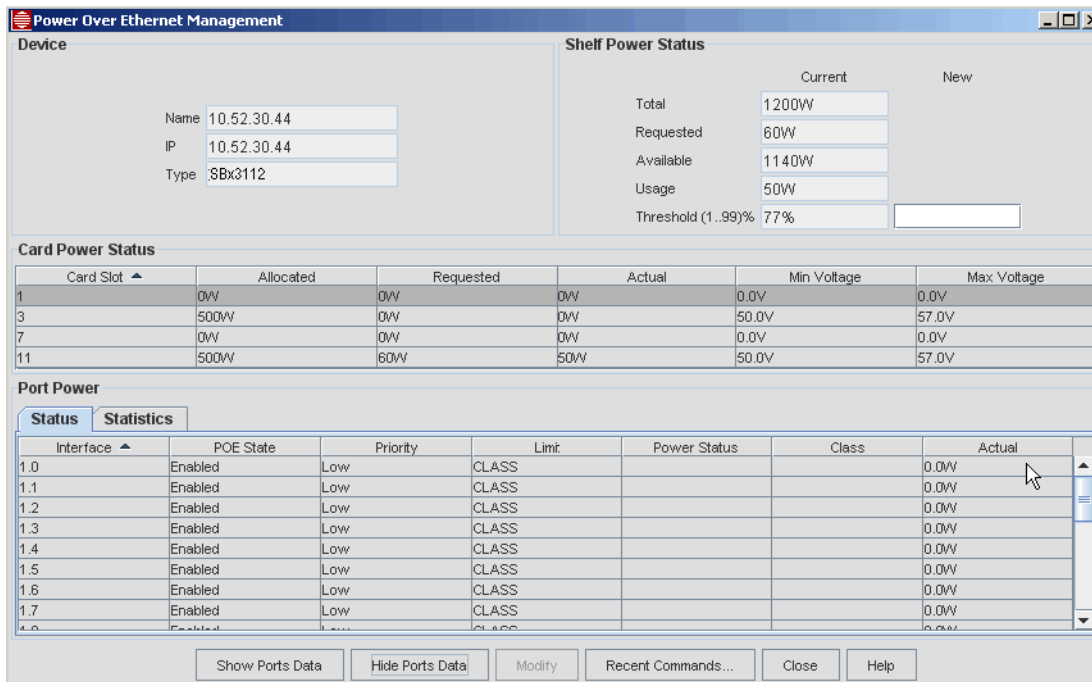

FIGURE 5-123 Power Over Ethernet Management Form - Ports

5.5.26 XE Cards (XE1, XE1S, XE4, XE6SFP, and XE6)

The XE1 card on the iMAP provides a 10GE link between 10G products. The XE4 and XE6SFP cards, unique to the SBx3112, provides four and six of these ports. The XE6 card, used in the iMAP 9700 and 9810 products, provides six of these ports. All have a general tab and allow for Enable, Disable, Restart, and Run Diags. Note that since these cards provide a high-bandwidth interface usually involving connections to upstream devices, care should be taken before disabling this cardtype.

5.5.27 GE24 Cards (GE24SFP, GE24POE, GE24RJ, GE24BX)

At the card level, all of the Card Details Forms have similar functions, with the GE24SFP, GE24POE, and GE24RJ for the SBx3112 and the GE24BX for the iMAP. Refer to product documentation for details.

Note: The GE24POE provides the Power over Ethernet service and is described in 5.5.25. The GE24RJ is the same as the GE24POE but does not provide POE service

5.6 Port Management (iMAP Devices)

5.6.1 Overview

This application for the iMAP devices allows the user to view, in a table format, the configuration of the device and then provision/configure its ports. Moreover, this table is updated real-time as changes occur to the ports.

Note: Controlling the port configuration involves understanding how provisioning data works in the iMAP devices, so an overview of provisioning data is given in 5.5.24.

Note: Throughout this Section, the Port Management Forms have the following common buttons:

- Recent Commands... - This brings up the Recent Commands window, a listing of the CLI commands and responses for the previous operation in the Port Management application. The user has the option to copy this to a Clipboard and then paste it into another file for record keeping.

- Close - This closes the Application.
- Help - This brings up the context-sensitive help file.

For complete information about port management and statistics, refer to the iMAP User Guide.

5.6.2 Accessing the Port Management Application

To access the Port Management application, right-click the device, and then select **Provision -> Port Management**. (You can also select the device. **Operations** appears on the main menu and the pull-down menus are the same, so choose **Provision -> Port Management**).

Figure 5-124 shows the **Port Management** window for a iMAP 9700. Table 5-26 describes the buttons and fields that are displayed.

Note: Provisioning ports can involve defining the attributes of a single port or more than one port. With the CES8 and NTE8 card, two ports are provisioned on the same form when configuring the two endpoints of a DS1/E1 connection. Provisioning dual DS1/E1 ports is explained in more detail in 6.16 and 6.17. Also, the Triple Play form can involve different port types. Refer to the next Note.

Note: Although many types of ports can be provisioned, they are all done through the two forms that define the services for a port, the **Provision New Triple Play Customer Form**, and the **Provision New DS1/E1 Port Form**, which can apply to the CES8 or the NTE8. This section explains these form and their fields; for an overview of the panels and fields that are used for various services, refer to 6.15.

Note: For the ADSL48A card, the port numbers go from 0 to 47, and the card number remains at the lower slot number for ports 24 to 47.

Note: In the Port Management window, an AtmBond shows up as type "ATMBOND". The bonded port does not appear in this window.

Note: In the EE version, provisioning of customer ports is not allowed. Refer to 6.10.17.

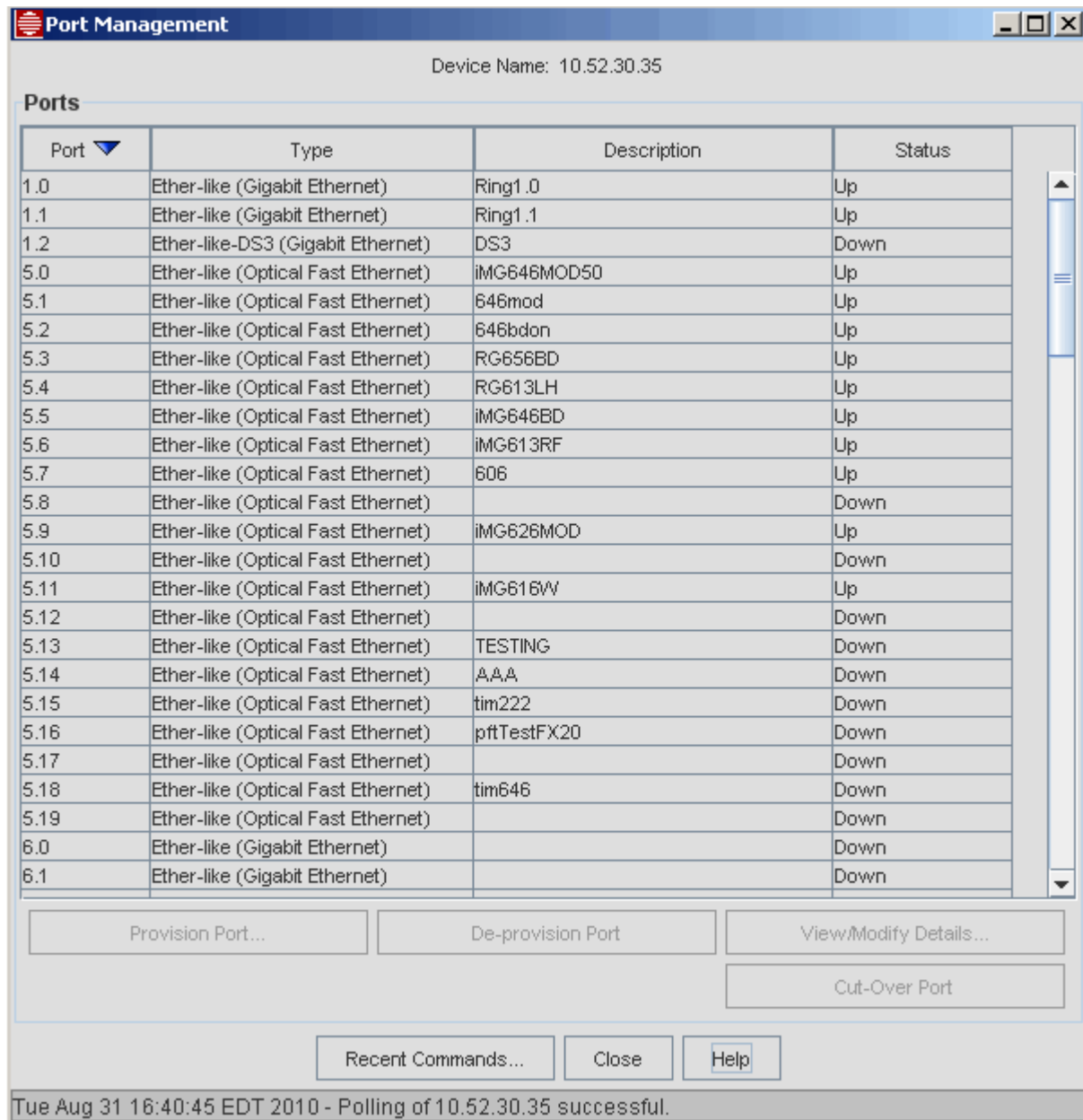

FIGURE 5-124 Port Management Form (here for iMAP 9700)

TABLE 5-26 Port Management Application Window

Field/Button	Description
Device Name	The Name given to the device in the Managed Objects property table
Port	The slot.port in the iMAP device
Port Type	Allowed port types are ADSL, SHDSL, Ether-like, POTS, DS1, E1, VDSL, and ATMBOND

TABLE 5-26 Port Management Application Window (Continued)

Field/Button	Description
Description (Customer ID)	An ID that can be given to uniquely identify the port. In most cases, the subscriber's telephone number is used. For rules on DS1/E1 customer IDs, refer to 6.16. <i>Note:</i> A customer ID should be a unique string and should apply to one customer line; creating multiple customers with the same Customer ID can make provisioning Triple Play confusing and may create additional (excessive) tabs on the GUI forms. <i>Note:</i> Also, do not use the * character in the Customer ID, since it will not be properly handled during any task involving a search.
Status	The status of the port that follows from the boolean AND of the Administrative State and Operational State (only if both are UP is the Status UP)
Provision New Customer/Port	Enabled after a port with no Customer ID is selected, it invokes the Provision Port form. Refer to the Note below.
De-Provision Customer/Port	Deletes the Customer ID and sets the Administrative State to DOWN. The status becomes OFFLINE. This operation also sets the port back to the AutoProv settings, removes any classifiers on the port, removes VCs 1-3 from the port, and sets the VLAN back to Untagged:1 Tagged None. Refer to the Note below.
View/Modify Details	Enabled when a port is selected, it invokes the Port Management Details form. Refer to the Note below.

Note: There are three versions of the Port Management window and Port Management Details form.

1. View Only

- The Port Management window excludes the Provision and De-Provision buttons.
- The Port Management Details form excludes the fields/buttons that allow values or states to be changed.

2. Provision - The same as View Only, but includes the Provision and De-Provision buttons.

3. Setting - The same as Provision, but includes the fields/buttons that allow values or states to be changed.

Control of these versions is through the NMS Security Manager settings. Refer to Section 4.

5.6.3 Provision New Customer/Port (Triple Play Form) - with Preferences

5.6.3.1 Overview

Selecting a non-provisioned port that is not an xDSL/CES8/NTE8/EPON port and then clicking **Provision New Customer/Port** invokes the **Provision New Triple Play Customer** form, as shown in Figure 5-125. This form includes the most important attributes for the port to ensure quality subscriber service. Table 5-27 lists these attributes.

The screenshot shows the 'Provision New Triple Play Customer' window. It includes sections for Customer Info, iMG/RG General Configuration, Video/Data Configuration, Voice Configuration, and Schedule. A 'Display Preferences' panel is open on the right, listing various configuration panels with checkboxes. The 'Bonded ADSL Ports' and 'Additional POTS Port when Bonded' options are highlighted with red boxes. The main form has several dropdown menus and text input fields, some of which are highlighted in red.

FIGURE 5-125 Provision New Triple Play Customer Form - Includes Display Preferences Panel

5.6.3.2 Field Descriptions

TABLE 5-27 Provision Port for Triple Play Customer Form

Panel	Field/Button	Description
Display Preferences	Brings up the Panel that has tick boxes for which Triple Play panels can be displayed in the Triple Play Form	Allows the user to choose which panels are allowed to display. By default, the most common panels are allowed to appear.
Top of Form	Description (Customer ID)	A way to identify the customer. The name should be descriptive so it can be easily recognized, especially on the Ports table in Network Inventory. The name should be unique to differentiate it from other customers, but in some configurations the name can apply to more than one port, such as DS1/E1 ports for CES. Refer to 6.16 and 7.2.7.
	Add Customer Info.	To include more details about the customer, an additional text field appears.

TABLE 5-27 Provision Port for Triple Play Customer Form

Panel	Field/Button	Description
RG General Configuration	RG General Profile	A pull-down with the pre-defined general profiles for the RG. When provisioning the RG the user should have already defined all the RG profile types. Refer to 7.4.2.
	RG MAC Address	The MAC address that uniquely identifies the RG device.
Video/Data Configuration	Access Device	A drop-down list of all the iMAP Devices that have ports that can support some (or all) aspects of triple play
	Slot.Port	Once the Access Device is chosen, the available ports on that device are listed in the drop-down list. When a port is chosen the port type appears next to the port in parentheses. <i>Note: The default state of ports on AlliedWare Plus devices has a customer name of 'portx.x.x' for all ports. You must deprovision the port to remove this customer name, then reprovision using the triple-play form to provision a relevant customer name.</i>
	Port Profile	Once the port (and therefore port type) is chosen, the available profiles for that port type appear in the drop-down list. When the port is provisioned, it will inherit the attributes of that profile. <i>Note: If the profile includes a VLAN, the VLAN fields are greyed out.</i> <i>Note: If IGMP snooping is set to OFF in the profile, MAC lookup cannot be done, so the STB fields are greyed out.</i>
	VLAN Settings	The VLANs to be associated with the port. The Untagged VLAN is the default VLAN (packets with no VLAN tag are given this number VLAN). The port may contain more than one untagged VLAN, with each VLAN number separated by a comma.
	IP Filtering (Allowed Ranges)	Incoming data to the ports (the ingress ports) can be filtered by IP address or a range of IP addresses. Refer to the <i>iMAP User Guide</i> .
	Allowed STB MAC Adrs.	STBs are configured with unicast MAC addresses; when associating an STB with a port number, take care in data filling the correct MAC address. Unicast MAC addresses have a 0 in the last bit of the first address group, so valid numbers are 00, 02, 04, 06, 08, 0A, 0C, and 0E. Refer to the <i>Allied iMAP User Guide</i> .

TABLE 5-27 Provision Port for Triple Play Customer Form

Panel	Field/Button	Description
Voice Configuration	POTS:	The attributes that support iMAP Devices that have ports that can support the POTS aspect of triple play. Specific attributes are controlled by the POTS Port Profile selected.
	Derived Voice	The attributes for Voice over IP provided by iMG/RGs. Specific attributes are controlled by the Derived Voice Service Profile (RG Voice profile) selected. If the profile specifies GenBand MGCP, then attributes are provided to directly configure the GenBand voice gateway. <i>Note: For GenBand, the NMS does not support TR-008.</i>
Bottom of Form	Provision	The ability of the port to provide service. The Administrative State must be up and then the system determines if the port can provide service.
	Close	Cancels the provisioning of the port.

5.6.3.3 Guided Input

As shown in Figure 5-125, fields that require datafill are highlighted to help the user fill out the applicable fields. The highlighted fields work as follows:

- Fields that require datafill are highlighted.
- When more than one field is highlighted, at least one of these fields require datafill.
- After one field is filled in, any fields that still require input are highlighted. Also, other fields may be enabled (highlighted) or disabled.
- If invalid data is input into a highlighted field, the field remains highlighted.

The figure also shows the Preferences Panel, allowing the user to control which panels are allowed to appear, so that certain fields that are never/rarely used do not appear.

Preferences work as follows:

- Preferences are persistent (over restarts of the client).
- Preferences are on a per-client basis.

Finally, note that the size of the form is persistent.

5.6.3.4 Guided Input for ADSL G.Bond

Provisioning is done through the Triple Play provisioning GUIs, and launching them is unchanged. However when an ADSL port is selected that is on a card that supports bonding, the GUI is changed as follows:

- ADSL-BOND type profiles are included in the Port Profile selector in addition to the regular ADSL profiles.
- Following the Slot.Port (the Primary Port) field is a new selector field, **Bond To**. It is populated with the other unassigned ports on the same card as the primary port. If the primary port is already the primary port of an AtmBond, the current bonded port is displayed; otherwise it is blank .
- Selecting a Blank profile entry enables the Bonded Port field, but makes it not required.
- Selecting an ADSL-BOND profile will make the Bond Port field a required entry.
- Selecting a port in the Bonded Port selector will limit the Port Profile selector to only ADSL-BOND type profiles (plus the Blank entry), and will display a second POTS line in the Voice Configuration panel.
- Selecting a blank bonded port removes any extra POTS line fields that are visible.

Refer to the following figure.

FIGURE 5-126 Triple Play for ADSL Bonded Ports

The display of these fields is controlled by new Preference entries, Bonded ADSL Ports, and Additional POTS Port when Bonded. Selecting a Blank profile entry enables the Bonded Port field, but makes it not required. Selecting a blank bonded port removes any extra POTS line fields that are visible. Refer to the following figure.

FIGURE 5-127 Preferences for Triple Play Form

5.6.4 Provision New Customer Port for Ethernet

For an ethernet port, a form allows the user to provision a Customer ID and apply a profile so that the port can be placed in service. Refer to the following figure.

The screenshot shows a web-based configuration window titled "Provision New Triple Play Customer". At the top, there is a "Description (Customer ID):" field with a red background. Below this is the "Video/Data Configuration" section, which includes "Access Device: 10.52.30.36", "Slot:Port: 16.0 (FX)", and "Port Profile:". Underneath are "VLAN Settings" with "Untagged VLAN: 1" and "Tagged VLAN(s):". The "Voice Configuration" section is empty. The "Schedule" section has radio buttons for "Now", "Hold", and "Schedule:". The "Schedule:" option is selected, with a date of "Aug 31, 2010", a time of "5:03 PM". At the bottom are buttons for "Provision", "Recent Commands...", "Close", and "Help".

FIGURE 5-128 Provision New Ether-Like Port

5.6.5 Provision New Customer/Port for ADSL

Selecting a non-provisioned ADSL port brings up the Triple Play Form that already includes the Access Device and selected port. The form is filled out for services as described in 5.6.3 and Section 7.

5.6.6 Provision New Customer/Port for CES8 (DS1/E1 Form)

Selecting a non-provisioned port that is a DS1/E1 port and then clicking **Provision New Customer/Port** invokes the **Provision New DS1/E1 Customer** form, as shown in Figure 5-129. This form includes the most important attributes for the port to ensure quality subscriber service. Table 5-28 lists these attributes.

Note: To provision CES efficiently, use this Provisioning Dialog; this will prevent errors that can occur when changing certain attributes on the DS1 Port Management form.

FIGURE 5-129 Provision New DS1 Port Form

TABLE 5-28 Provision Port for DS1/E1Form

Panel	Field/Button	Description
Top of Form	Description (Customer ID)	A way to identify the customer. The name should be descriptive so it can be easily recognized, especially on the Ports table in Network Inventory. The name should be unique to differentiate it from other customers, but in some configurations the name can apply to more than one port, such as DS1/E1 ports for CES. Refer to 6.16.

TABLE 5-28 Provision Port for DS1/E1Form

Panel	Field/Button	Description
Port Configuration	Device	A drop-down of all the devices that have CES8 cards configured as DS1 ports (or, if the port is an E1, all the devices that have CES8 cards configured as E1 ports).
	Ports	A drop-down of the ports (card.slot) in the selected device that are DS1 or E1, depending on the port type being configured.
	Port Profile	The available profiles for the port type (DS1 or E1) appear in the drop-down list. When the port is provisioned, it will inherit the attributes of that profile.
	Timing Reference	Where the port will get its clocking reference from. The choices are: <ul style="list-style-type: none"> - SELF - Itself - CONNECTION -The interface to which it is connected. Note that when this is chosen, the PSPAN automatically has its RTP set to ON, since a PSPAN must be using RTP protocol to be used as a timing reference. - CARD - The “card-level” timing reference (See 5.5.14)
PSPAN Configuration	IP Interface	The IP interface that has been configured on the card.
	RTP:	Whether RTP timing will be On or OFF. Refer to the Timing Reference field above.
	UDP port	The UDP port of the near end interface, the local receive ID. Must be unique within an IP address on a card.
	Peer IP Address	The peer IP address of the IP interface the PSPAN is built on. <i>Note: If the Peer Port is configured, this field is greyed out.</i>
	Peer UDP Port	Must match the peer’s UDPPORT attribute <i>Note: If the Peer Port is configured, this value is automatically given to the peer port.</i>
Peer Port Configuration (optional)	Device	The device that contains the peer DS1/E1 port.
	Port	A drop-down of the ports (card.slot) in the selected device that are DS1 or E1, depending on the port type being configured <i>Note: A peer port can be on a different device or the same device as the port, but cannot be on the same card.</i>
	Port Profile	The available profiles for the port type (DS1 or E1) appear in the drop-down list. When the port is provisioned, it will inherit the attributes of that profile.
	Timing Reference	Where the port will get its clocking reference from. The choices are the same as for the port.
Bottom of Form	Provision	Enabled only after the minimum number of correct fields have been data filled, and these fields have been data filled with valid values.

5.6.7 Provision New Customer/Port for NTE8 (DS1/E1 Form)

Selecting a non-provisioned port that is a DS1/E1 port and then clicking **Provision New Customer/Port** invokes the **Provision New NTE-DS1 Port** form, as shown in Figure 5-129. This form includes the most important attributes for the port to ensure quality subscriber service. Table 5-29 lists these attributes.

Note: To provision the NTE8 efficiently, use this Provisioning Dialog; this will prevent errors that can occur when changing certain attributes on the DS1 Port Management form.

FIGURE 5-130 Provision New NTE-DS1 Port Form

TABLE 5-29 Provision Port for NTE8-DS1/E1Form

Panel	Field/Button	Description
Top of Form	Description (Customer ID)	A way to identify the customer. The name should be descriptive so it can be easily recognized, especially on the Ports table in Network Inventory. The name should be unique to differentiate it from other customers, but in some configurations the name can apply to more than one port, such as DS1/E1 ports for NTE8. Refer to 6.17.
PPP Configuration	Device	A drop-down of all the devices that have NTE8 cards configured as DS1 ports (or, if the port is an E1, all the devices that have NTE8 cards configured as E1 ports).
	Slot.Port	A drop-down of the ports (card.slot) in the selected device that are DS1 or E1, depending on the port type being configured.

TABLE 5-29 Provision Port for NTE8-DS1/E1Form

Panel	Field/Button	Description
	Port Profile	The available profiles for the port type (DS1 or E1) appear in the drop-down list. When the port is provisioned, it will inherit the attributes of that profile.
	MLPPP Instance	<p>The MLPPP that the DS1/E1 will be associated with. When more than one DS1/E1 is bundled together, each DS1/E1 is associated with a PPP, and the PPPs are all associated with one MLPPP. The pull-down has three attributes:</p> <ul style="list-style-type: none"> - The numbering of the MLPPP begins with the slot and an id number starting at 8. - The membership includes the members of the MLPPP and shows Empty if there are no PPPs associated with the MLPPP. - The provisioning status shows whether the MLPPP with this id has already been created. If it has, it shows EXISTS. If not, it shows NEW. <p>If there is only one DS1/E1 to be part of the connection (and therefore only one PPP), there is no MLPPP instance and so NONE should be chosen.</p> <p><i>Note: The user can still create an MLPPP instance with only one PPP if desired.</i></p>
	Timing Reference	<p>Where the port will get its clocking reference from. The choices are:</p> <ul style="list-style-type: none"> - SELF - Itself - CARD - The “card-level” timing reference (See 5.5.15)
PPP Configuration	PPP Parameters	The parameters for the associated PPP. The default values are displayed.
	MLPPP Parameters	<p>The MLPPP parameters.</p> <p>If NONE has been selected for the MLPPP Instance, these fields are blank.</p> <p>If an MLPPP instance is selected, and then a peer port is selected, the MLPPP Instance field in the Peer Port Configuration panel is activated.</p>
	VLAN Parameters	
Peer Port Configuration (optional)	Device	The device that contains the peer DS1/E1 port.
	Port	<p>A drop-down of the ports (card.slot) in the selected device that are DS1 or E1, depending on the port type being configured</p> <p><i>Note: A peer port can be on a different device or the same device as the port, but cannot be on the same card.</i></p>
	Port Profile	The available profiles for the port type (DS1 or E1) appear in the drop-down list. When the port is provisioned, it will inherit the attributes of that profile.
	MLPPP Instance	The MLPPP instance that the peer DS1/E1 port is associated with.

TABLE 5-29 Provision Port for NTE8-DS1/E1Form

Panel	Field/Button	Description
	Timing Reference	Where the port will get its clocking reference from.
Bottom of Form	Provision	Enabled only after the minimum number of correct fields have been data filled, and these fields have been data filled with valid values.

5.6.8 Provision New Customer / Port for SHDSL16/24

The following figure shows the Triple Play Customer Form for a SHDSL24 port. Note that you can only choose odd-numbered port for first port if doing bonded.

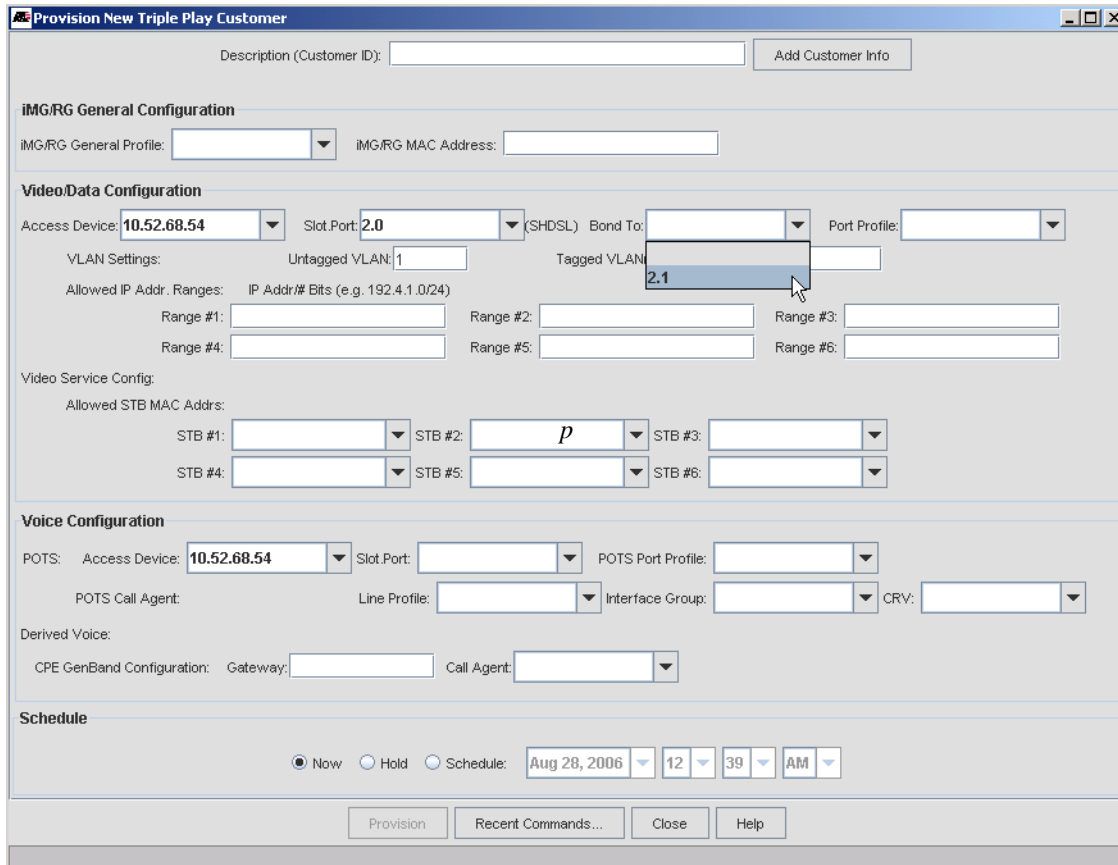

FIGURE 5-131 Provisioning SHDSL24 Port

5.6.9 Provision New Customer / Port for EPON2

The EPON port is part of the configuration that includes the EPON2 card (for passive optical network) and the iMG646PX-ON model which includes the Optical Networking Unit (ONU).

Note: For complete information about the EPON2 card, ONU, QoS policies being associated with VLANs, etc. refer to the iMAP Software Reference Manual.

The numbering for the EPON ports is the standard slot.port.

The following figure shows the Port Management Form for a device and how the EPON ports are shown. The EPON2 port is 5.0.

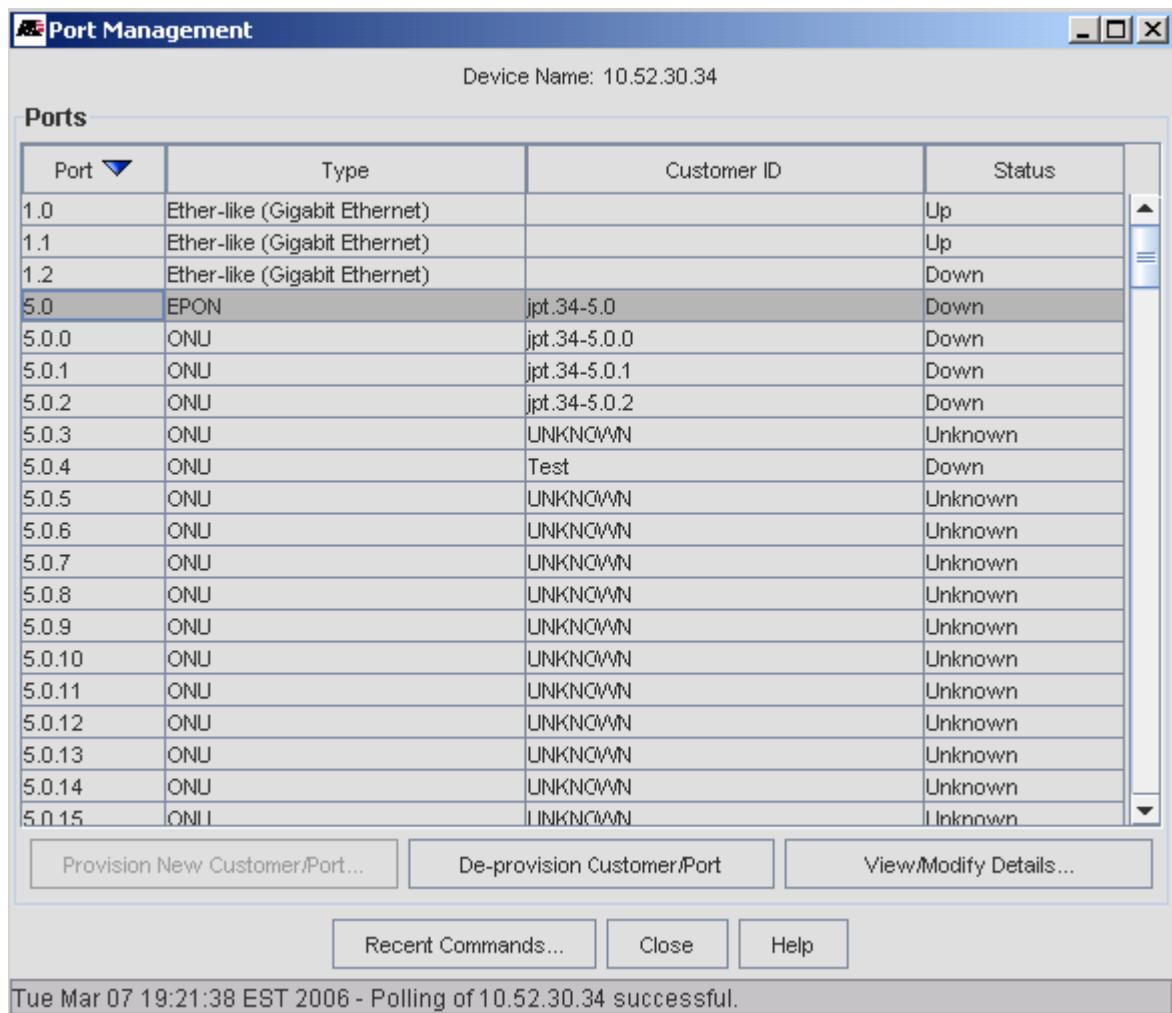

FIGURE 5-132 Provision EPON Port

To provision on EPON port, the user should select a port that has a status of Unknown with no Customer ID and then select the activated Provision New Customer Port button.

Warning: If the user tries to provision a port with configured ONUs, the ONU configurations are destroyed, as shown in the following figure.

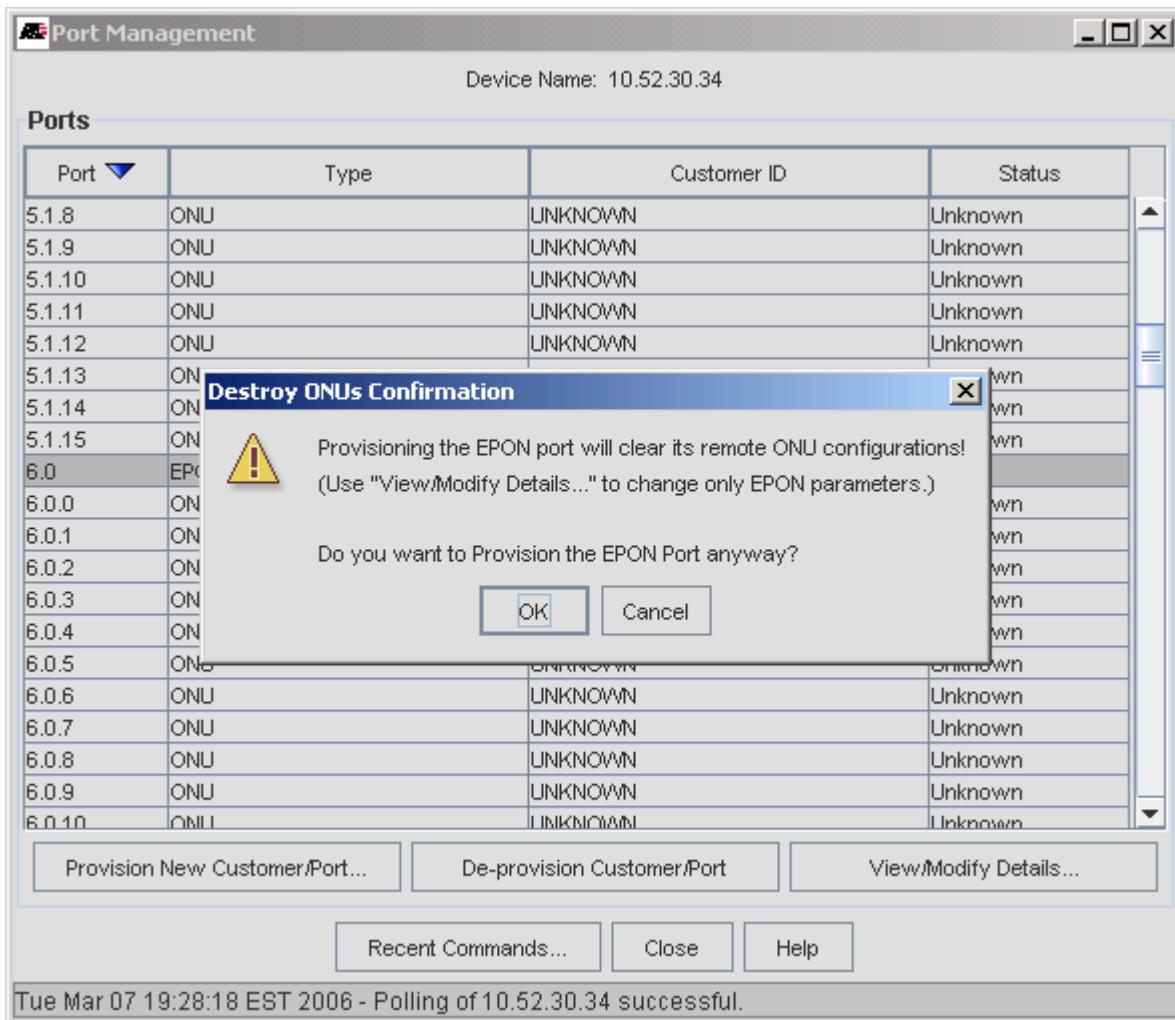

FIGURE 5-133 Trying to Provision an EPON with Configured ONUs

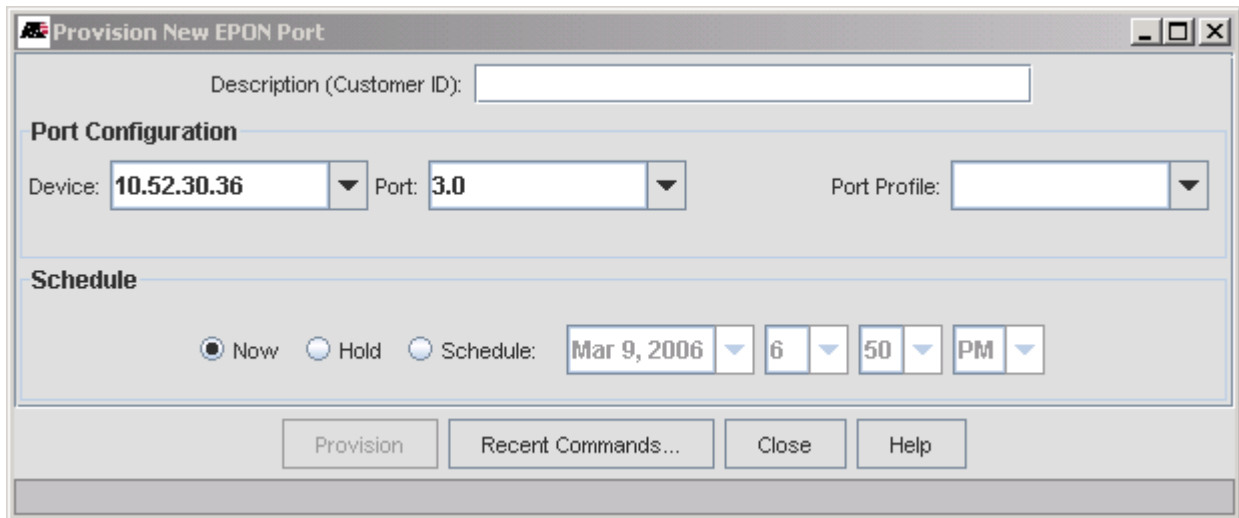

FIGURE 5-134 Provision New EPON Port

5.6.10 Provision New Customer / Port for ONU

The ONU is part of the configuration that includes the EPON2 card (for passive optical network) and the Optical Networking Unit (ONU).

Note: For complete information about the EPON2 card, ONU, QoS policies being associated with VLANs, etc. refer to the iMAP User Guide.

From the perspective of the AlliedView NMS, the ONU is considered a customer port regardless of whether it connected to an iMG646PX-ON, ON1000, or other Media Converter, and therefore is included with the other ports on an iMAP device that can be provisioned using the Triple Play Form. The numbering for the ONUs is a three digit port number, the first two being the EPON port interface.

When creating the ONU, the system will query to ONU and datafill the configuration as part of an iMG/RG or ON1000. When the user wishes to change the ONU type, it must be destroyed and then re-created.

The following figure shows the Port Management Form for a device and how the ONU ports are shown. The EPON2 port is 9.1 and so the ONUs are numbered 9.1.0, 9.1.1, etc.

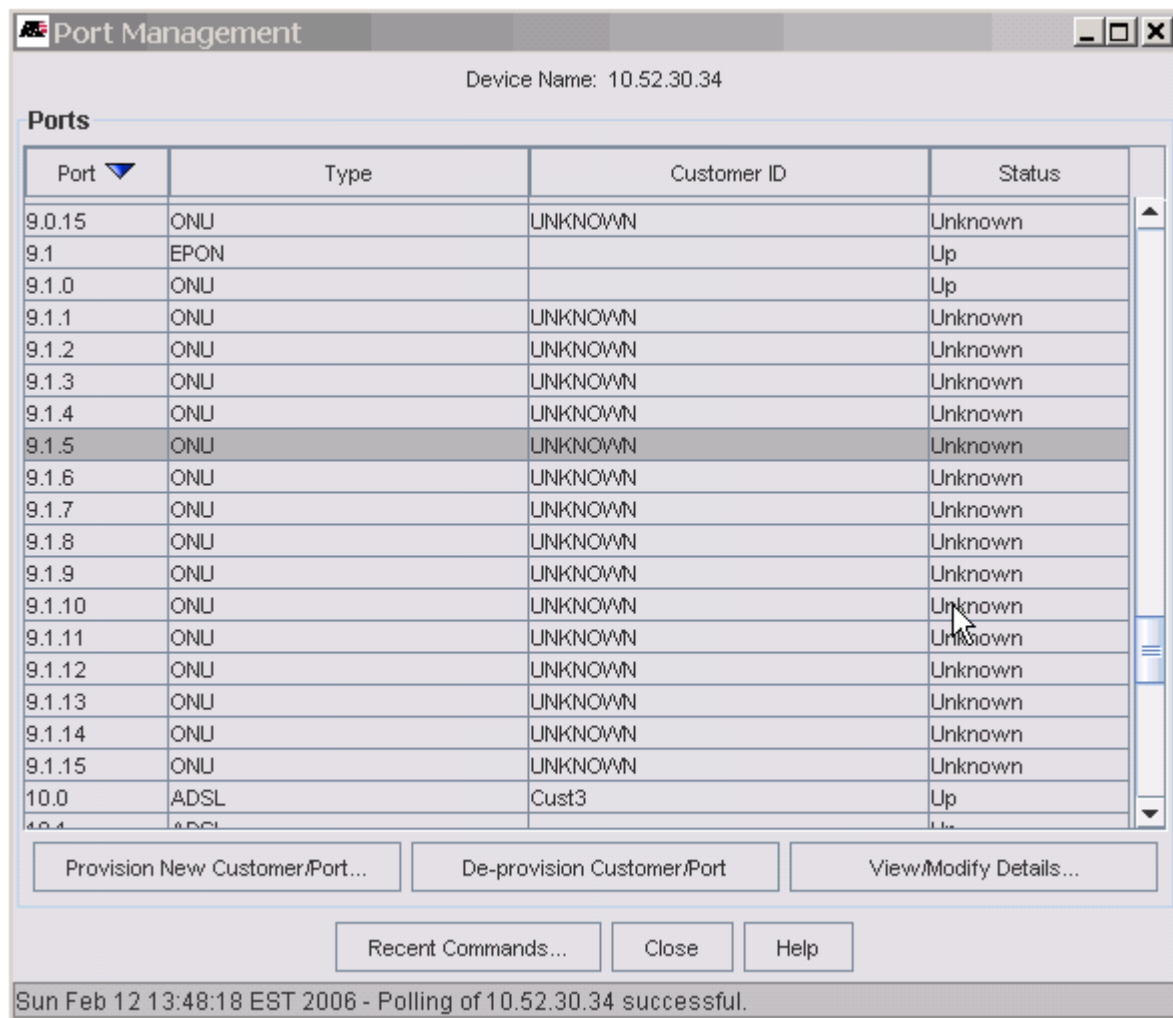

Port	Type	Customer ID	Status
9.0.15	ONU	UNKNOWN	Unknown
9.1	EPON		Up
9.1.0	ONU		Up
9.1.1	ONU	UNKNOWN	Unknown
9.1.2	ONU	UNKNOWN	Unknown
9.1.3	ONU	UNKNOWN	Unknown
9.1.4	ONU	UNKNOWN	Unknown
9.1.5	ONU	UNKNOWN	Unknown
9.1.6	ONU	UNKNOWN	Unknown
9.1.7	ONU	UNKNOWN	Unknown
9.1.8	ONU	UNKNOWN	Unknown
9.1.9	ONU	UNKNOWN	Unknown
9.1.10	ONU	UNKNOWN	Unknown
9.1.11	ONU	UNKNOWN	Unknown
9.1.12	ONU	UNKNOWN	Unknown
9.1.13	ONU	UNKNOWN	Unknown
9.1.14	ONU	UNKNOWN	Unknown
9.1.15	ONU	UNKNOWN	Unknown
10.0	ADSL	Cust3	Up

Provision New Customer/Port... De-provision Customer/Port View/Modify Details...

Recent Commands... Close Help

Sun Feb 12 13:48:18 EST 2006 - Polling of 10.52.30.34 successful.

FIGURE 5-135 Port Management Form for Device with EPON2/ONU Ports

The user can then select Provision New Customer Port to bring up the Triple Play form, as shown in the following figure.

Provision New Triple Play Customer

Description (Customer ID):

iMG/RG General Configuration

iMG/RG General Profile: iMG/RG MAC Address:

Video/Data Configuration

Access Device: Slot.Port: (ONU) ONU MAC Addr.: Port Profile:

VLAN Settings: Untagged VLAN: Tagged VLAN(s):

Allowed IP Addr. Ranges: IP Addr/# Bits (e.g. 192.4.1.0/24)

Range #1: Range #2: Range #3:

Range #4: Range #5: Range #6:

Video Service Config:

Allowed STB MAC Adrs:

STB #1: STB #2: STB #3:

STB #4: STB #5: STB #6:

Voice Configuration

Derived Voice:

GenBand Configuration: Gateway: Call Agent:

Schedule

Now Hold Schedule:

FIGURE 5-136 Triple Play Form for an ONU Customer Port

Note the following attributes of the Triple Play Form when provisioning an ONU:

- The Slot.Port has three digits for the ONU.
- The MAC address that has been assigned to the ONU is displayed.

Note: If the administrator is provisioning an iMG646PX-ON, the iMG/RG General Configuration Panel would be filled in, as shown in Section 7.

5.6.11 Provision New Customer / Port for VDSL24A/B

In release 9.0, the VDSL card connects to a VDSL modem.

Note: A VDSL-based iMG/RG is not yet available.

The screenshot shows a software window titled "Provision New Triple Play Customer". At the top, there is a "Description (Customer ID):" field and an "Add Customer Info" button. Below this is the "iMG/RG General Configuration" section, which includes a dropdown for "iMG/RG General Profile" and a text field for "iMG/RG MAC Address".

The "Video/Data Configuration" section contains several fields: "Access Device" (set to 10.52.30.36), "Slot Port" (set to 5.0), and "(VDSL)". There are also fields for "Port Profile", "VLAN Settings" (with "Untagged VLAN" set to 1 and "Tagged VLAN(s)" empty), and "Allowed IP Addr. Ranges" (with six empty range fields). Below this is the "Video Service Config" section with six "STB" dropdown menus.

The "Voice Configuration" section includes "POTS" settings: "Access Device" (10.52.30.36), "Slot Port", "POTS Port Profile", "POTS Call Agent", "Line Profile", "Interface Group", and "CRV". Below this is the "Derived Voice" section with "CPE GenBand Configuration" (Gateway and Call Agent fields).

At the bottom is the "Schedule" section with radio buttons for "Now", "Hold", and "Schedule". The "Schedule" option is selected, and the date is set to "Aug 28, 2006" with time set to "12:48 AM".

At the very bottom of the window are buttons for "Provision", "Recent Commands...", "Close", and "Help".

FIGURE 5-137 Provision VDSL Port

Note the following on filling out the Triple-Play form for VDSL:

- The pull-down for the iMG/RG General configuration is left blank.
- The Voice Configuration panel is left blank.

5.6.12 Overview of Triple Play Service Management Form

Once a port is configured for video, data, or voice, the Triple Play Service Management Form is used to view or modify the port's attributes. Depending on the type of port configured and the services configured on that port, this management form displays the various attributes in a hierarchical multi-tab format. The following sections give the different ways this form can appear:

- Status (5.6.13)
- Add a voice Line (for GenBand only) - on Status tab form (5.6.14)
- iMG/RG (5.6.15)
- Ethernet Configuration (5.6.16)
- ADSL Configuration (5.6.17)
- SHDSL Configuration (5.6.18)
- Voice Configuration (5.6.19)
- CES8 (5.6.20)
- NTE8 (5.6.21)
- EPON2/ONU (5.6.24)
- ATM Bonding (5.6.31)

Note: In provisioning Triple Play, more than one card can be included in the customer configuration, and so a combination of tabs will appear so the user can query all attributes of the customer.

Note: The iMG/RG is included in the Customer Management Form. Note that once the iMG/RG is provisioned with the iMAP customer port, this form displays the same information whether viewing the RG device or the iMAP interfacing port.

Note: This section includes an overview of what the tabs include for the iMG/RG, but focuses on ports that are not configured with an iMG/RG. For details on the Service Management form for the iMG/RG, refer to Section 7.

5.6.13 Status Tab

The Status tab gives the main provisioning attributes for the port/RG and their status. It also allows the administrator to add a voice line, as detailed in 5.6.14. The following figure shows an example form and its attributes.

The status form allows the user to see in one set of screens the attributes that were used when provisioning the iMG (use of profiles, VLANs, etc.) as well as the status of the iMG.

For voice service, there are two sets of information under the Voice configuration panel:

- **POTS** - When configured, this is voice service using a POTS-based card (POTS24, PAC24) and an ADSL splitter. This includes the slot.port of the POTS24 card, the call agent, and the status of the POTS24 card and port. If there is no POTS configured, there is the text "No POTS port configured."

Note: If the POTS24 configuration uses a soft switch other than GenBand, the POTS call agent attributes are listed as unknown..

- **Derived Voice** - When configured, this is VoIP provided by the iMG/RG/iBG and can use one of many softswitches, including GenBand. If the configuration uses GenBand, then the Derived Voice attributes are shown, including the Voice Endpoint, which must be configured for this voice service to work. If another softswitch is used, there is the message "Derived voice gateway information is not available." This means that the NMS does not manage the device that provides the service.

5.6.14 Add Derived Voice Line for GenBand (on Status Tab Form)

When the GenBand configuration is being used, the administrator can add a voice line immediately on the Status form by clicking the Add Derived Voice Line button. The following form appears:

The screenshot shows a web browser window titled "Add Voice Line". The form contains the following fields and values:

- Customer ID: keith_g6
- MGC Device: 10.52.200.110
- iMG/RG Voice Endpoint: rgvoip-0-d-da-1-45-59.nms-team.telesyn.corp
- Voice Endpoint Port: TEL2
- Line Profile: POTS24
- Interface Group: gr303 (gr303)
- CRV: (empty)

Below the fields are two buttons: "Add" and "Recent Commands". A list of numbers (41-52) is displayed, with 42 highlighted. A mouse cursor is pointing at the list.

FIGURE 5-139 Add Voice Line Form (one MGC Device Configured)

If a voice line has already been configured, the MGCP Device and iMG/RG Voice Endpoint (DNS name) are already provided, and the pull-downs should be filled in descending order, since one will drive what is available in the next pull-down. After choosing **Add**, you should see an additional MGCP Line Info tab in the Voice Configuration form. The corresponding line in the Voice Service tab in the iMG/RG form must then be enabled (by clicking the Enabled tic box for the New Line Configuration).

If a voice line is being added for the first time, the available devices appear in the MGC Device pull-down. Once a device is chosen, the user must input the MAC address of the iMG as well as the attributes from the remaining pull downs. Refer to the following figure.

The screenshot shows a window titled "Add Voice Line" with the following fields and values:

- Customer ID: IMGPX8
- MGC Device: genband.lab.telesyn.corp
- iMG/RG Voice Endpoint: (empty)
- Voice Endpoint Port: (empty)
- Line Profile: (empty)
- Interface Group: (empty)
- CRV: (empty)

At the bottom of the form, there are four buttons: "Add", "Recent Commands...", "Close", and "Help".

FIGURE 5-140 Add Voice Line Form (more than one MGC Device Configured)

Note: This form is only used when the GenBand is providing the derived voice.

Note: The NMS does not support GenBand provisioning with TR-008.

5.6.15 iMG/RG Tab

This form lists all the major attributes of the iMG/RG and its services, and includes the attributes that were filled out as part of the iMG/RG Profiles. Refer to Section 7 for details about provisioning the iMG/RG.

Note: At the bottom of the form are two buttons, **Modify** and **Save iMG/RG Configuration**. After changing any fields in any tabbed forms in the iMG/RG Form, the user should click on **Modify**, wait until finished, and then **Save iMG/RG Configuration**. This ensures the changes take effect immediately and after an iMG/RG reboot.

5.6.15.1 Mgmt. Info Tab

This form includes the iMG/RG Type and the iMG/RG General Profile that is associated with the iMG/RG. From this form, the user can change the associated RG General Profile (Mgmt. Info tab) as well as specific attributes that do not match what was in the Profile. Refer to 7.4.2 for a description of these fields.

Note: The user should not change individual fields since they would no longer match those of the associated General Profile. If they are changed, an * appears next to the General Profile Name.

5.6.15.2 Wireless Tab

For the iMG/RG Wireless devices (as well as Comtrend, starting in release 11.0 SP3), the wireless tab includes the parameters that are relevant for the wireless configuration. For certain devices, the subscriber has the ability to change these parameters. Refer to 7.9.6.

5.6.15.3 Port Assignments Tab

This form shows the Port assignments that were data filled in the associated RG General Profile (Port Assignment tab). The user selects a port in the New Port Assignment Panel and selects the different attributes from the pull-downs.

Note: The user should not change individual fields since they would no longer match those of the associated General Profile.

5.6.15.4 IP Routes Tab

This form shows the IP Route assignments that were data filled in the associated RG General Profile (IP Routes tab). The user selects a route in the New IP Routes Panel, selects or deselects the Enable tic box, and then selects the different attributes from the pull-downs.

Note: The user should not change individual fields since they would no longer match those of the associated General Profile.

5.6.15.5 Internet Service Tabs

These forms show the Internet Service attributes that were data filled in the associated Internet Service Profile. From these forms, the user can change the associated Internet Service Profile as well as specific attributes that do not match what was in the Profile. Refer to 7.4.3 for a description of these fields

The tabs that appear starting in Release 9.0 are:

- Internet Service
- Security
- Firewall
- NAT

Note: The user should not change individual fields since they would no longer match those of the associated Profile.

5.6.15.6 Video Service Tab

This form shows the Video Service attributes that were data filled in the associated Video Service Profile. From this form, the user can change the associated Video Service Profile as well as specific attributes that do not match what was in the Profile. Refer to 7.4.4 for a description of these fields

Note: The user should not change individual fields since they would no longer match those of the associated Profile.

5.6.15.7 Voice Service Tab

This form shows the Voice Service attributes that were data filled in the associated Voice Service Profile. From this form, the user can change the associated Voice Service Profile as well as specific attributes that do not match what was in the Profile. Refer to 7.4.5 for a description of these fields

Note: The user should not change individual fields since they would no longer match those of the associated Profile.

5.6.15.8 Diagnostic Tab for iMG6x6MOD/iMG7x6MOD

In the MOD iMGs, the LAN diagnostic feature was added in release 3.7. In NMS release 12.0, the NMS supports this LAN diagnostic functionality. Refer to 7.14.2.

5.6.16 Ether-like Config. Tab (Upstream and Downstream)

Following are the types of ether-like ports that can be provisioned.

- See “Ether-Like Port (General Tab)” on page 144.
- See “Ether-Like Port (General Tab) - iMG/RG” on page 146.
- See “Ether-Like Port (Port Statistics Tab)” on page 146.
- See “Ether-Like Port (Port Thresholds Tab)” on page 147.
- See “Ether-Like Port (Device Data Collection Tab)” on page 148.
- See “Ether-Like Port (Stats Graph Tab)” on page 149.
- See “Ether-Like Port (IP Filters Tab)” on page 151.
- See “Ether-Like Port (Port Log Tab)” on page 152.
- See “Ether-Like Port (DS3-SFP Tab)” on page 152.
- See “Ether-Like Port (POE Tab)” on page 152.

5.6.16.1 Ether-Like Port (General Tab)

When a port is labeled Ether-like, then it is an ethernet port facing the network or a customer port facing and customer device, such as an iMG/RG. The following subsections go through these provisioning screens, starting with the General tab.

Note: For the SBx3112, there is an additional tab for PoE for the GE24POE card. Refer to 5.6.16.10.

The screenshot shows the 'Ether-like Port Management' window for device '10.52.30.35' and port '1.0'. The 'General' tab is selected. The interface is divided into 'Current Value' and 'New Value' columns. The 'Current Value' column displays the following information:

- Admin. State/Status: Up
- Oper. State/Link State: Up
- Port Up-Time (ddd:hh:mm:ss): 003:20:41:34
- Status: Online
- Port Type: Gigabit Ethernet
- Actual Flow Control: ON
- Interface Profile Name: None
- Profile: None
- Description (Customer ID):
- Auto Negotiation: On
- Flow Control: Autonegotiate
- Egress Rate Limiter (Name or None): None
- Untagged VLAN (1..4094 or None): None
- Tagged VLANs (comma separated list or None): 3,6,7,10,20,21,...

The 'New Value' column contains input fields for the 'Profile', 'Description', 'Auto Negotiation', 'Flow Control', 'Egress Rate Limiter', 'Untagged VLAN', and 'Tagged VLANs'.

At the bottom of the window, there are buttons for 'Modify', 'Clear Entry Fields', 'Disable', 'Enable', 'Alarms...', 'Recent Commands...', 'Close', and 'Help'. A status bar at the very bottom indicates: 'Tue Nov 04 13:02:03 EST 2008 - Polling of 10.52.30.35 successful.'

FIGURE 5-141 Ether like Port Management Window - General for Upstream

TABLE 5-30 Ether-like Port Management for iMAP Devices - General Tab - Upstream

Field/Button	Description
Admin. State/Status:	The Administrative State can be controlled and determines the Operational State. Refer to 5.5.24.
Oper. State/Link State:	The ability of the port to provide service. The Administrative State must be up and then the system determines if the port can provide service.
Up-Time	Amount of time the physical interface has been in the UP-UP-Online state.
Status:	The status of the port that follows form the Administrative State and Operational State. For meanings, refer to the iMAP Software Reference Manual. <ul style="list-style-type: none"> - ONLINE - IN TEST - FAILED - OFFLINE - DEPENDENCY - DEGRADED - NOT INSTALLED - INITIALIZATION REQUIRED - TERMINATING
Port Type:	For these Ethernet ports, Optical Fast Ethernet
Actual Flow Control:	Whether Flow Control is on, regardless of how it was provisioned.
Actual Port Speed:	The measured port speed versus what was actually configured
Actual Duplex Mode:	The duplex mode actually attained
Description (Customer ID):	An ID that can be given to uniquely identify the port.
Auto Negotiation:	Whether certain port attributes are auto-negotiated with the remote peer.
Flow Control:	The provisioned Flow Control
Egress Rate Limiter	Whether Egress Rate Limiting has been applied
Untagged VLAN	The VLAN that is applied if the packet has no VLAN id
Tagged VLANs	The VLANs that are allowed on the port (packet has one of the VLAN IDs)
Direction	Whether the interface is towards the network or customer.
Modify	Enables the any changes have been made to the settings, makes them
Disable	Disable the port (after a confirmation window). This makes the overall state DOWN.
Enable	Enable the port. This makes the overall STATE UP if the port can be brought into service.
Alarms	Brings up the Alarm view for the selected port.
Clear Entry Fields	Clears the writable fields of any values.
Command History	Views the CLI commands and responses for the operations performed in the Port Management application. This is the same for all tabs.
Close	Closes the View Details application (the window as well as the tab). This is the same for all tabs.

Note: The Autonegotiation, Flow Control, Speed, and Duplex Mode fields appear according to the port type. (FX has Flow Control, GE has Autonegotiate and Flow Control, FE has Flow Control, Speed, and Duplex Mode. Refer to the Feature Guide for details.)

5.6.16.2 Ether-Like Port (General Tab) - iMG/RG

When the Ethernet port interfaces with an iMG/RG, there are additional fields that appear. Refer to the following figure.

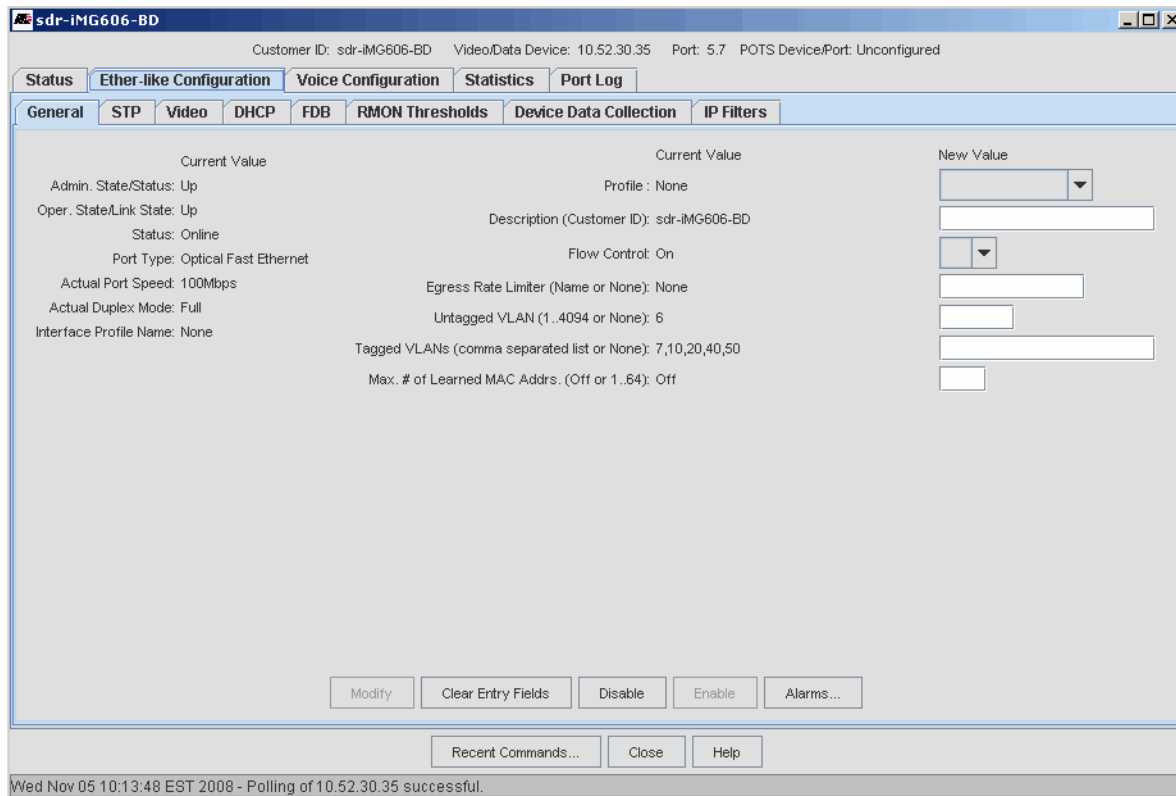

FIGURE 5-142 Ether like Port Management Window - iMG/RG

Many of the values for the RG-specific fields are controlled by the Profile being used. These are explained in 7.4. Note the following fields in particular:

- Multicast MAC Addresses (Video Tab)
- STB MAC Addresses (Video Tab) - MAC addresses for each STB. Addresses can be typed in, selected from the pull-down, or removed (with selection Remove from pull-down).
- Enabled DHCP Relay Instances (DHCP tab) - These are the DHCP instances that are used that allow the RG to boot up and be provisioned correctly. Ensure that all the relevant DHCP instances are enabled. Refer to 7.2.5.

For the tab form descriptions, refer to the ADSL Configuration tab, 5.6.17.

5.6.16.3 Ether-Like Port (Port Statistics Tab)

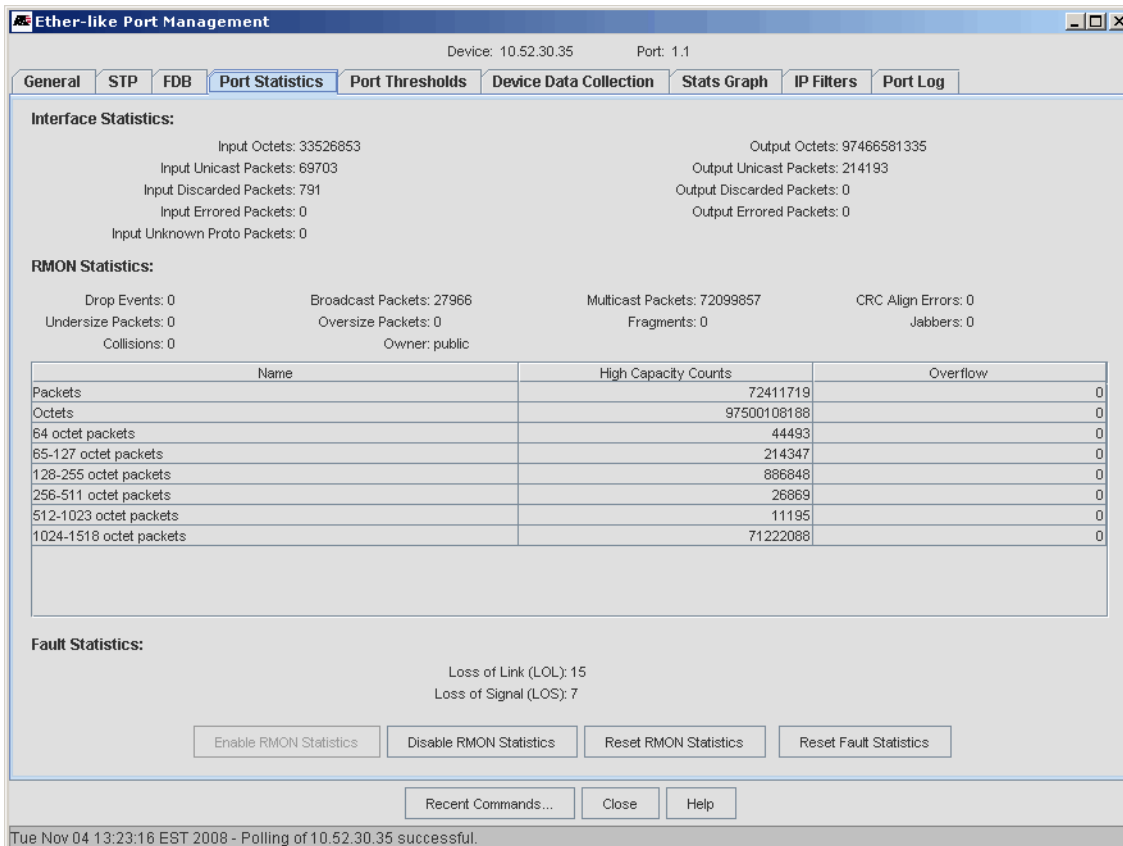

FIGURE 5-143 Ether like Port Management Window - Port Statistics Tab

TABLE 5-31 Provision Port Form for Port Management - Port Statistics Tab

Field/Button	Description
RMON Statistics:	Lists the standard RMON statistics. For an explanation, refer to the iMAP User Guide.
Interface Statistics:	Lists the standard faults for an ethernet port. For an explanation of what these mean and what actions to take (if any), refer to the iMAP Log / Troubleshooting Manual.
Enable Statistics	If the port is UP, this button starts the collection of both RMON and Fault statistics.
Disable Statistics	Discontinues the collection of both RMON and Fault statistics.
Reset Fault Statistics	Resets to 0 the Fault Statistics
Reset RMON Statistics	Resets to 0 the RMON statistics
Command History	Views the CLI commands and responses for the operations performed in the Port Management application. This is the same for all tabs.
Close	Closes the View Details application (the window as well as the tab). This is the same for all tabs.

5.6.16.4 Ether-Like Port (Port Thresholds Tab)

When an RMON statistic is configured, the attributes determine the interval the statistic will be taken and at what threshold (rising and falling) a log/alarm will be produced. The Port Thresholds tab lists these for the statistics chosen. Form this form statistics can be added, modified, or deleted. Refer to the following figure and table.

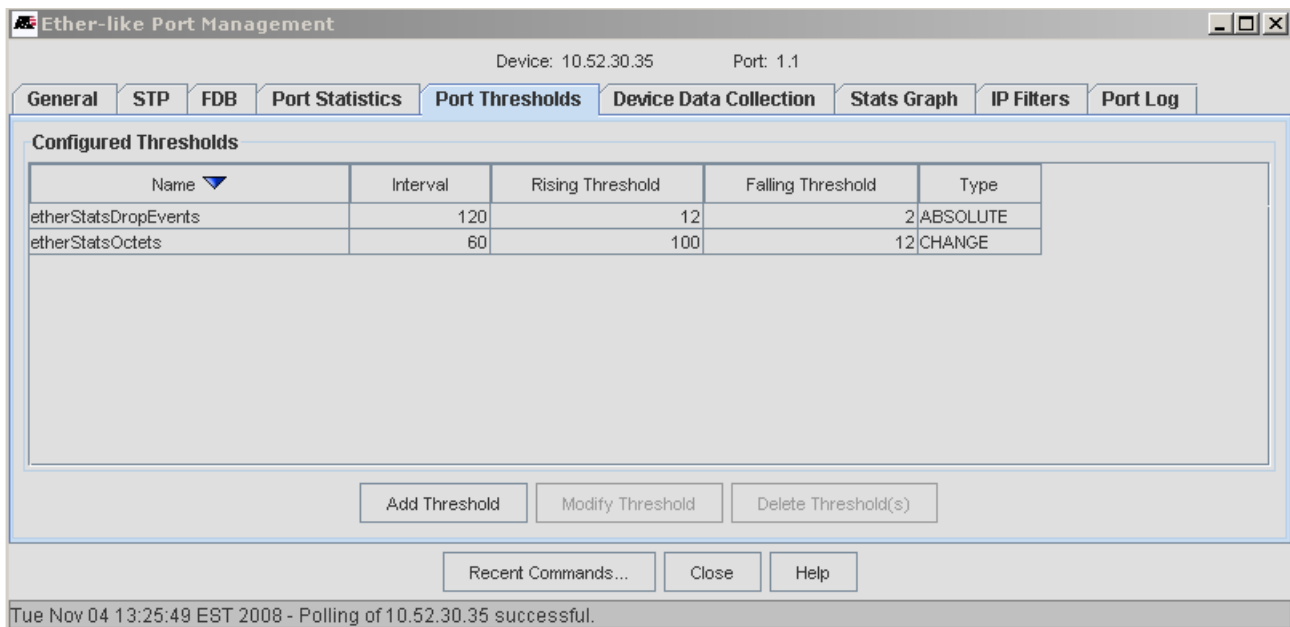

FIGURE 5-144 Ether like Port Management Window - Port Thresholds Tab

TABLE 5-32 Provision Port Form for Port Management - Port Thresholds Tab

Field/Button	Description
Name	One of the RMON statistics
Interval	Interval in number of seconds, from 2 to 3600 (one hour)
Rising Threshold	The number at which an alarm/log is raised when the number is exceeded.
Falling Threshold	The number at which an alarm/log is raised when the number falls above this number. Note that only when this threshold is crossed can another Rising Threshold alarm be raised when the number crosses the Rising Threshold.
Type	The type of threshold to be defined: <ul style="list-style-type: none"> - ABSOLUTE - The statistic must be reset before the threshold can be crossed again and a log produced. - CHANGE - The logs for thresholds are produced multiple times as the thresholds are crossed. (See Falling Threshold above to understand how this works.)
Add Threshold	Bring up the Add RMON Threshold to Port Form. The fields match what will be displayed.
Modify Threshold	Modify the values for an already created threshold.
Command History	Views the CLI commands and responses for the operations performed in the Port Management application. This is the same for all tabs.
Close	Closes the View Details application (the window as well as the tab). This is the same for all tabs.

5.6.16.5 Ether-Like Port (Device Data Collection Tab)

The history of statistical data is collected what are called buckets, which collect a certain amount of data over a specific time. By recording and then observing these buckets, users can spot trends. This form is used to define the buckets and their attributes. Refer to the following table and graph.

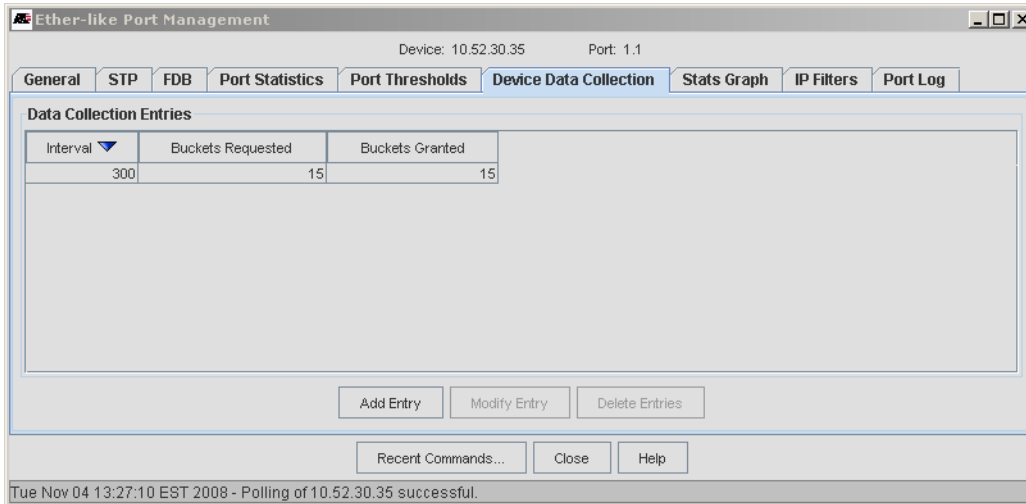

FIGURE 5-145 Ether like Port Management Window - Device Data Collection Tab

TABLE 5-33 Provision Port Form for Port Management - Device Data Collection Tab

Field/Button	Description
Interval	The period of time in seconds statistics will be gathered for a bucket, from 2 to 3600 (one hour)
Buckets Requested	The number of buckets that will be filled before the first bucket is overwritten, from 1 to 2700.
Buckets Granted	The actual number of buckets the device allows.
Valid	Whether the interval and bucket combination are valid. If they are, the column is Valid .
Add Entry	Add an interval and bucket combination row.
Modify Entry	Modify a selected interval and bucket combination row.
Delete Entries	Delete the selected entries.
Command History	Views the CLI commands and responses for the operations performed in the Port Management application.
Close	Closes the View Details application (the window as well as the tab).

5.6.16.6 Ether-Like Port (Stats Graph Tab)

This window makes a graph of selected statistics and displays them with varying attributes. Refer to the following figure and table.

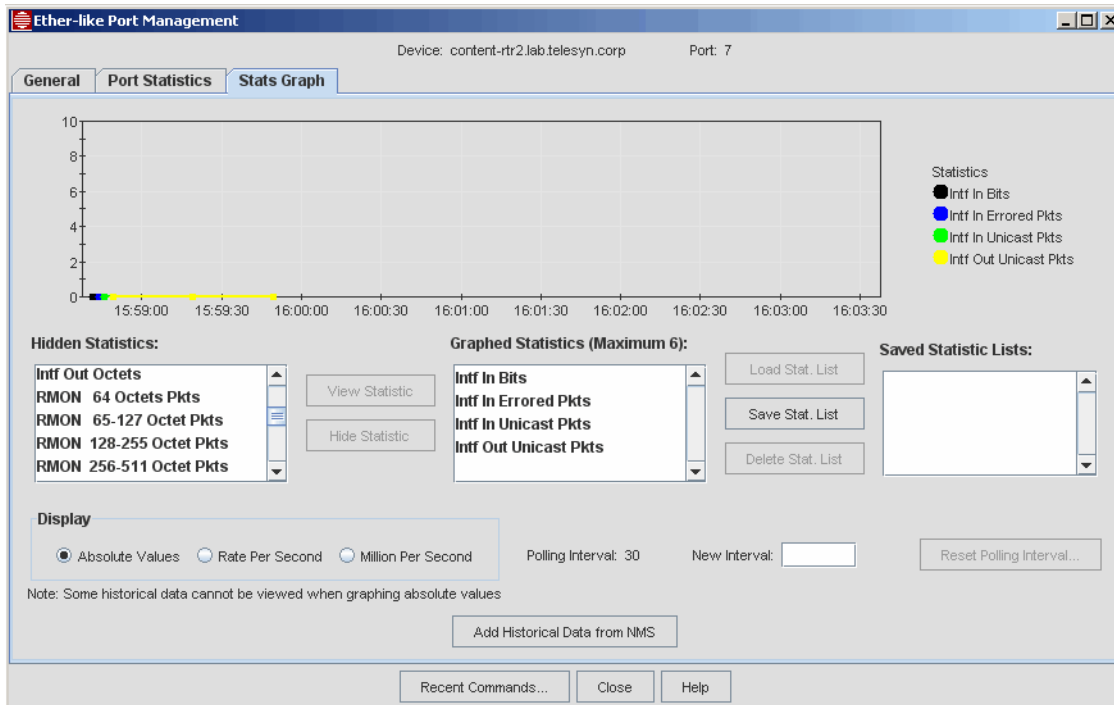

FIGURE 5-146 Ether like Port Management Window - Stats Graph Tab

TABLE 5-34 Provision Port Form for Port Management - Stats Graph Tab

Field/Button	Description
Hidden Statistics:	Statistics not added to the resulting graph
View Statistic:	Enabled when a statistic is chosen form Hidden Statistics, clicking this button adds it to the graph/
Hide Statistic:	Enabled when a statistic is chosen form Graphed Statistics, clicking this button deletes it from the graph/
Display	The attribute that controls the display: - Absolute Values - Rate Per Second - Million Per Second
Polling Interval:	Current Polling Interval in seconds
New Interval:	Sets a new interval for polling. This is set with the Reset Polling Interval button.
Enable Statistics	Enables the graph for the statistics chosen.
Disable Statistics:	Disables the graph
Add Historical Data from NMS:	Adds the data collected previously from NMS port management
Add Historical Data from Device:	Adds the data collected previously (buckets) from the device
Command History	Views the CLI commands and responses for the operations performed in the Port Management application. This is the same for all tabs.
Close	Closes the View Details application (the window as well as the tab). This is the same for all tabs.

5.6.16.7 Ether-Like Port (IP Filters Tab)

For traffic management, the iMAP devices allow the user to control a set of filters on ports, with each classifier given a rank or precedence (the lower the number, the higher the precedence). This form allows the user to list the classifiers that have already been defined and to control the precedence. Refer to the following figure and table.

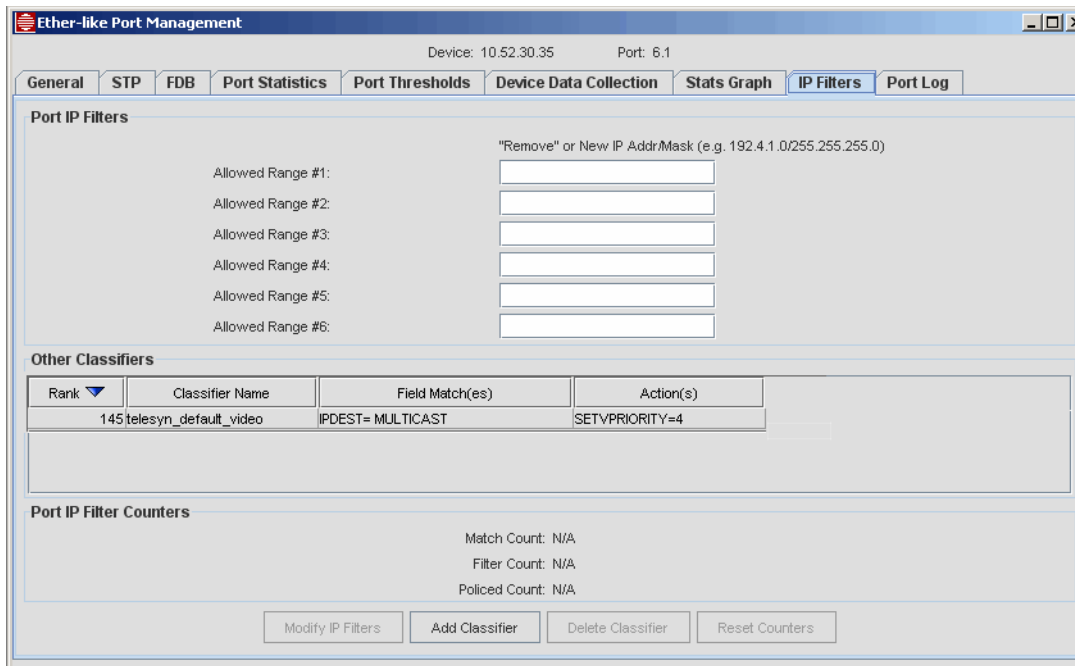

FIGURE 5-147 Ether like Port Management Window - IP Filters Tab

TABLE 5-35 Provision Port Form for Port Management - IP Filters Tab

Field/Button	Description
Rank	The precedence of the classifier
Classifier Name	The name of the classifier that has already been defined.
Field Match(es)	The matching rules for the classifier.
Action(s)	The actions to occur when there is a match
Port IP Filter Counters:	The counter for packets set against this classifier - Match Count - Filter Count - Policed Count
Add Classifier	Bring up the Add Classifier to Port Form. The data filled classifiers are listed, and the user can chose one of these and can define the precedence.
Delete Classifier	Deletes the classifier from the port
Reset Counters	Reset the counters to 0
Command History	Views the CLI commands and responses for the operations performed in the Port Management application. This is the same for all tabs.
Close	Closes the View Details application (the window as well as the tab). This is the same for all tabs.

5.6.16.8 Ether-Like Port (Port Log Tab)

Selecting the **Port Log** tab invokes a table that lists all the port-related management logs that have been generated. This window has the same columns as the ADSL Port Management window for Port Log.

For a description of management logs and the meaning of fields, refer to the iMAP Log / Troubleshooting Manual.

5.6.16.9 Ether-Like Port (DS3-SFP Tab)

Starting in release 12.0 for the iMAP 9000 series devices, a DS3 SFP is supported off of the GE3 and GE8 cards, which allows a DS3 interface and a Gigabit Ethernet interworking function. For details, refer to 6.10.16.

5.6.16.10 Ether-Like Port (POE Tab)

To view and modify the settings of an Ethernet port that has POE configured, a POE tab is added, as shown in the following figure.

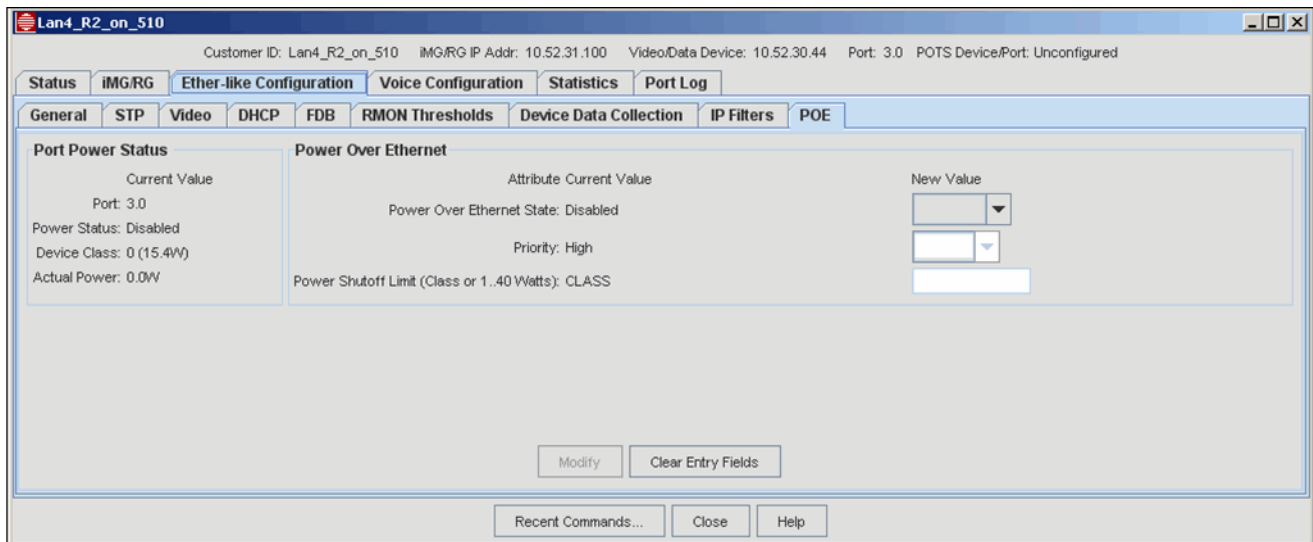

FIGURE 5-148 Service Management GUI for POE

5.6.17 ADSL Configuration Tab

5.6.17.1 Status Tab

The Status Tab Form is shown in Figure 5-149.

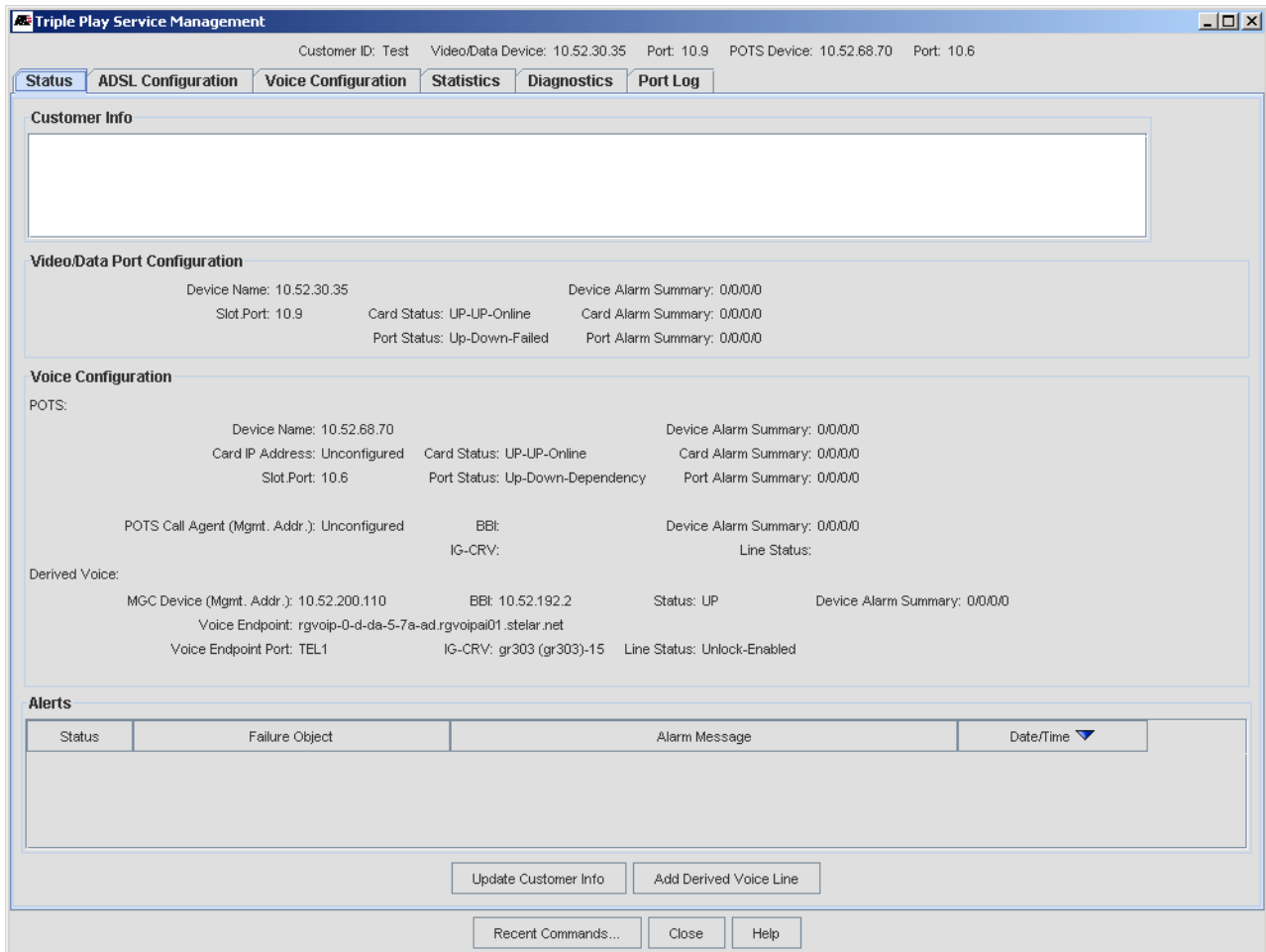

FIGURE 5-149 ADSL Configuration Form - Status Tab

For a data-only port using ADSL (no POTS or Derived Voice configuration), only the Video/Data Port panel has status information on the state of the port. Included is Alerts Panel that lists the current associated alarms.

If the ADSL port is part of a Bond configuration, the Port details tab is expanded to show the Bond status, as well as status of all the ADSL ports. The alerts table contains alarms for all components, device, card, bond, and ADSL ports. Refer to the following figure.

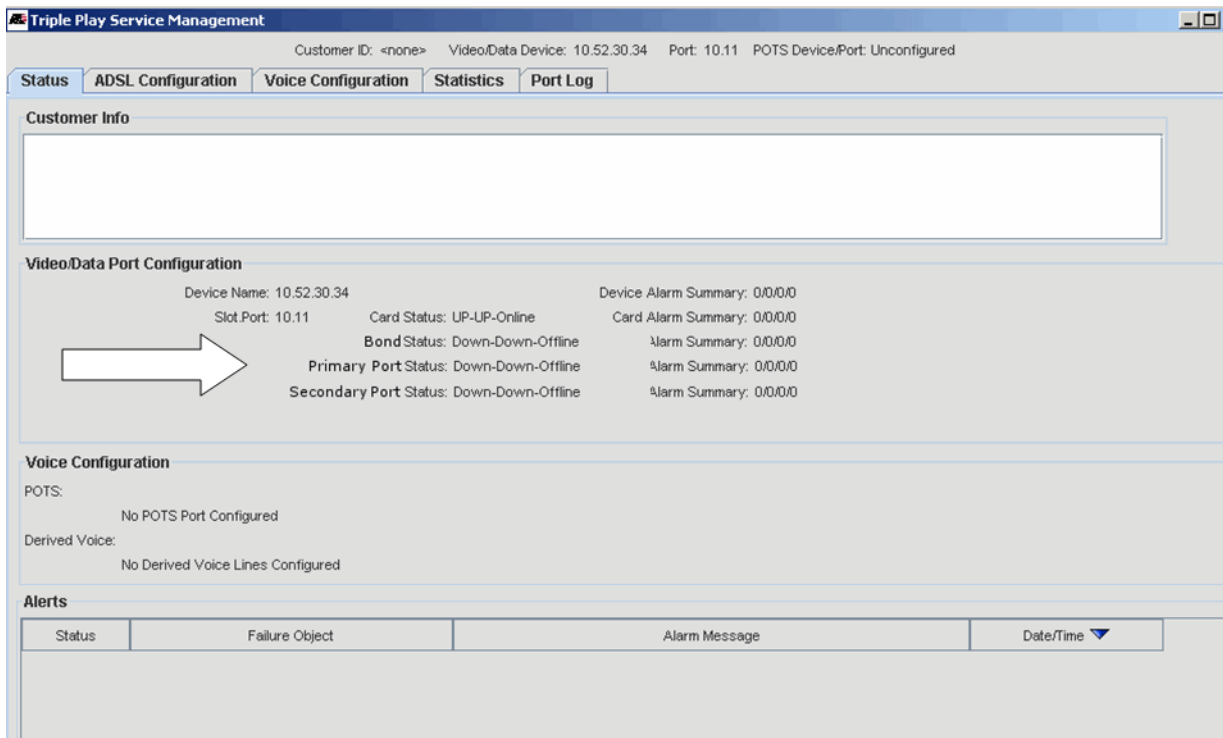

FIGURE 5-150 ADSL Status - Bonded Port

5.6.17.2 ADSL Configuration Tab - Overview

The ADSL Configuration tab has the following associated forms, each with its own tab:

- General
- VCs/VLANs
- Video
- DHCP
- FDB
- PMON Thresholds
- RMON Thresholds
- Device Data Coll.
- IP Filters

These are shown in the following figures. Following each figure is a table that describes the panels/fields of the form.

5.6.17.3 ADSL Configuration Tab - General

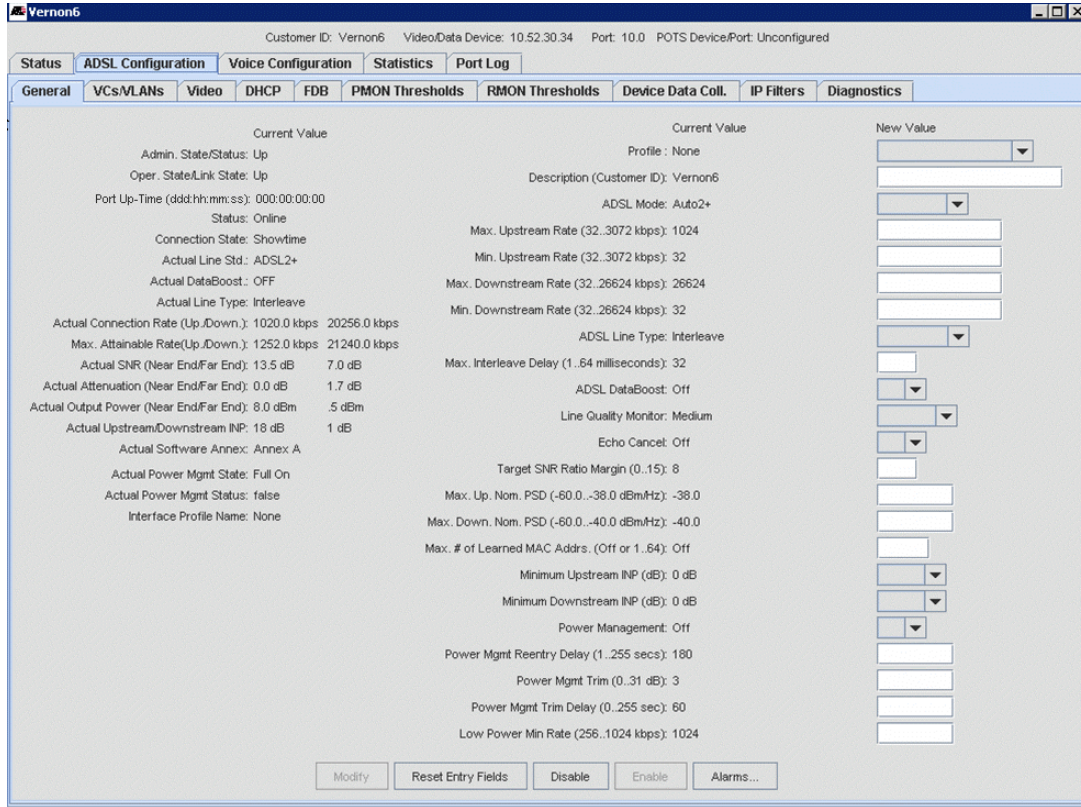

FIGURE 5-151 ADSL Configuration Form - General Tab

TABLE 5-36 ADSL Configuration Form, General Tab

Field/Button	Description
Admin. State	The Administrative State can be controlled and determines the Operational State. Refer to 5.5.24 .
Oper. State/Link State	The ability of the port to provide service. The Administrative State must be up and then the system determines if the port can provide service.
Port Up-Time	Amount of time the physical interface has been in the UP-UP-Online state.
Status	The status of the port that follows from the Administrative State and Operational State. For meanings, refer to the iMAP User Guide, Section 4. <ul style="list-style-type: none"> - ONLINE - IN TEST - FAILED - OFFLINE - DEPENDENCY - DEGRADED - NOT INSTALLED - INITIALIZATION REQUIRED - TERMINATING

TABLE 5-36 ADSL Configuration Form, General Tab (Continued)

Field/Button	Description
Connection State	The connection state, such as Idle or Showtime
Actual Line Std.	The line standard that was actually chosen.
Actual Databoost	Whether the DATABOOST feature has been implemented
Actual Line Type	The line type that was actually chosen.
Actual Upstream/Downstream Rate	The upstream/downstream rate that was actually attained.
Max. Attainable Upstream/Downstream Rate	The possible upstream/downstream rate according to dsl type and mode.
Actual SNR (Near End/Far End)	The signal-noise ratio for near end/far end that was actually attained.
Actual Attenuation (Near End/Far End)	The attenuation for near end/far end that was actually attained.
Actual Output Power (Near End/Far End)	The output power achieved for near end/far end.
Actual Software Annex	The Annex (A, B, or C) that is being used
Actual Power Mgmt State	The state the interface is in for power reduction (Full On, Low Power, Idle)
Actual Power Mgmt Status	Whether the power management feature has been activated for the interface
Actual Upstream INP	The actual impulse noise protection value for upstream
Actual Downstream INP	The actual impulse noise protection value for downstream
Profile	Which profile is being used (AutoProv or none, which uses default values).
Description (Customer ID)	An ID that can be given to uniquely identify the port. In most cases, the subscriber's telephone number is used. Refer to 7.2.7.
Max. Upstream Rate	The maximum upstream rate that is provisioned.
Min. Upstream Rate	The minimum upstream rate that is provisioned.
Max. Downstream Rate	The maximum downstream rate that is provisioned.
Min. Downstream Rate	The minimum downstream rate that is provisioned.
Target SNR Margin	Specifies the target signal-to-noise ratio (in dB) to achieve on an ADSL port.
ADSL Line Type	Specifies the ADSL line type as per ITU G.992. Allowed values are FAST and INTERLEAVE, although FAST is not allowed if the MODE is GLITE. Refer to the iMAP User's Guide, Section 4.
ADSL Mode	Specifies the ADSL line mode standard. Refer to the iMAP User's Guide, Section 4.
ADSL Databoost	Whether the Databoost feature has been provisioned
Line Quality Monitor	The level the line quality monitor has been set at. Refer to the iMAP User Guide.
Max. Interleave Delay	Specifies the maximum interleave delay in milliseconds used when the ADSL linetype is set to INTERLEAVE. Refer to the iMAP User's Guide, Section 4.
Echo Cancel	Specifies whether echo cancellation is utilized on ADSL ports running G.DMT mode as per ITU-T. Refer to the iMAP User's Guide, Section 4.
Max. # of Learned MAC Addresses	Depending on feature provisioning, the number of MAC addresses that can be learned (or Off)
Minimum Upstream INP	Sets the minimum impulse noise protection value for upstream.
Minimum Downstream INP	Sets the minimum impulse noise protection value for downstream.
Power Management	Changes the current power management state.
Power Mgmt Reentry Delay	The amount of time that must elapse before re-entering the Low Power state after a transition to the Full On state. (Should not be set to a value less than 120 seconds)

TABLE 5-36 ADSL Configuration Form, General Tab (Continued)

Field/Button	Description
Power Mgmt Trim	The maximum aggregate transmit power reduction (trimming) that can be performed with each power trim operation in the Low Power state.
Power Mgmt Trim Delay	The amount of time that must elapse before an additional reduction (trimming) of power occurs in the Low Power state.
Low Power Min Rate	The minimum net data rate for the bearer channel while operating in the Low Power state. The value for LOWPOWERRATE must be between MAXDOWNSTREAMRATE and MINDOWNSTREAMRATE
Max. Upstream Nominal PSD	VDSL/ADSL power spectrum density limits are defined by the band plan and determine this value.
Max. Downstream Nominal PSD	VDSL/ADSL power spectrum density limits are defined by the band plan and determine this value.
Modify	Enabled when a value in New Value field has been entered, modifies the attributes according to the updated values. There is an error message if a value is invalid.
Clear Entry Fields	Clear any fields that have been datafilled but not yet Modified
Enable	Enabled if the port is in an Administrative State of DOWN, enables the port and so brings the Administrative State to UP. If possible (for example, the ADSL card must be enabled), the Operational State will change to UP.
Disable	Enabled if the port is in an Administrative State of UP, disables the port and so brings the Administrative State to DOWN. The Operational State will also change to DOWN.
Alarms	Invokes the Alarm table of the Fault Management Object.

The values on this form can be modified as follows:

Note: This requires that the port be disabled, which will interrupt service on the port.

1. Click **Disable** to disable the port. A dialog box will appear warning you that service on the port will be interrupted. If you wish to proceed, click **Yes**.
2. Modify the information as needed.
3. Click **Modify** to save the changes.
4. Click **Enable** to re-enable the port.

For an ADSL Bonded port, the General Tab of the Port Details window contains information about the ATMBond. Each ADSL port that belong to the bond group has its own tab. There is the button on the panel “Add Bonded Port.”, to allow adding another port to the group. This button is disabled when the group is full. Refer to the following figures.

Note: Currently only two pairs can be bonded, but a group can be created with only one pair.

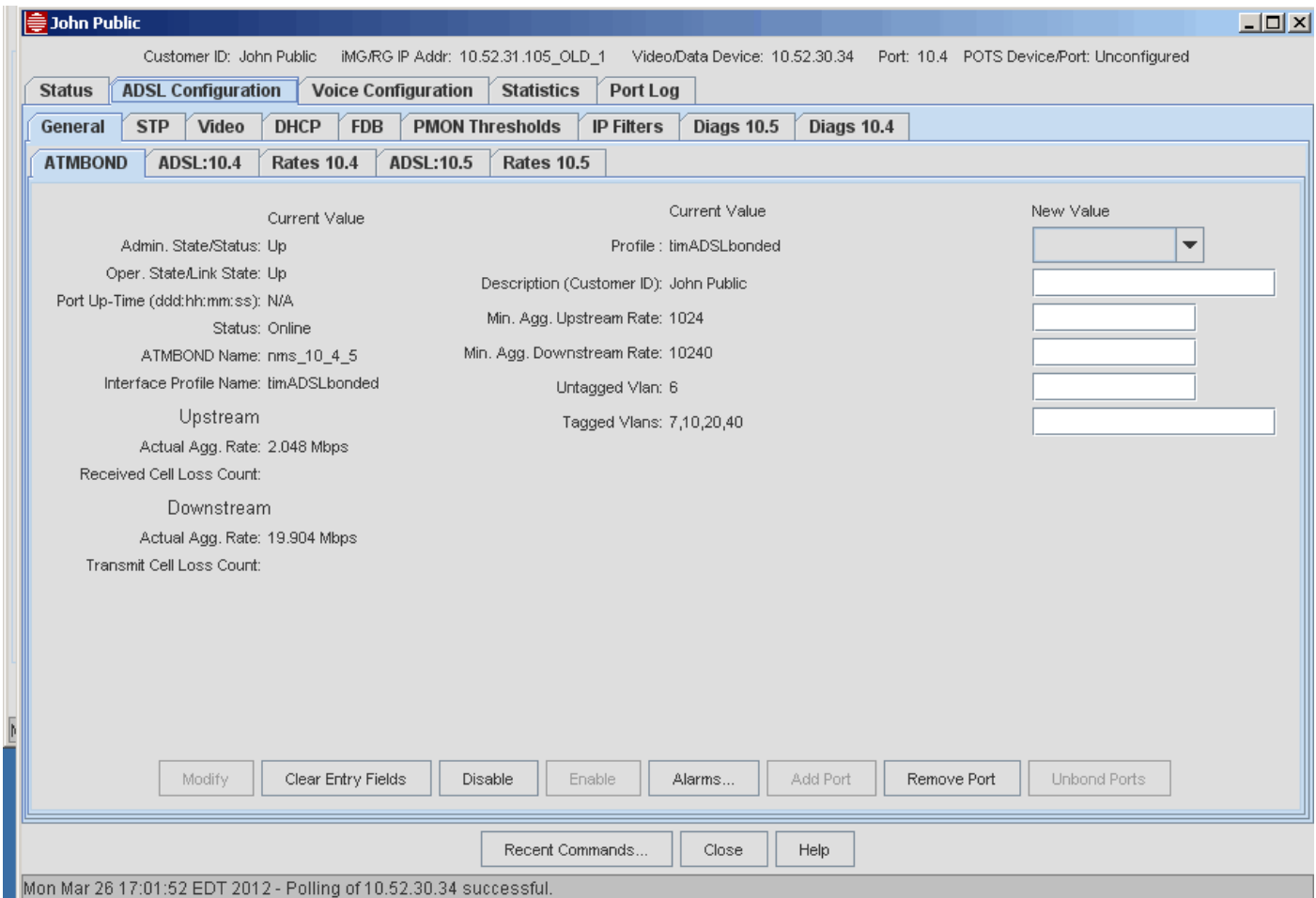
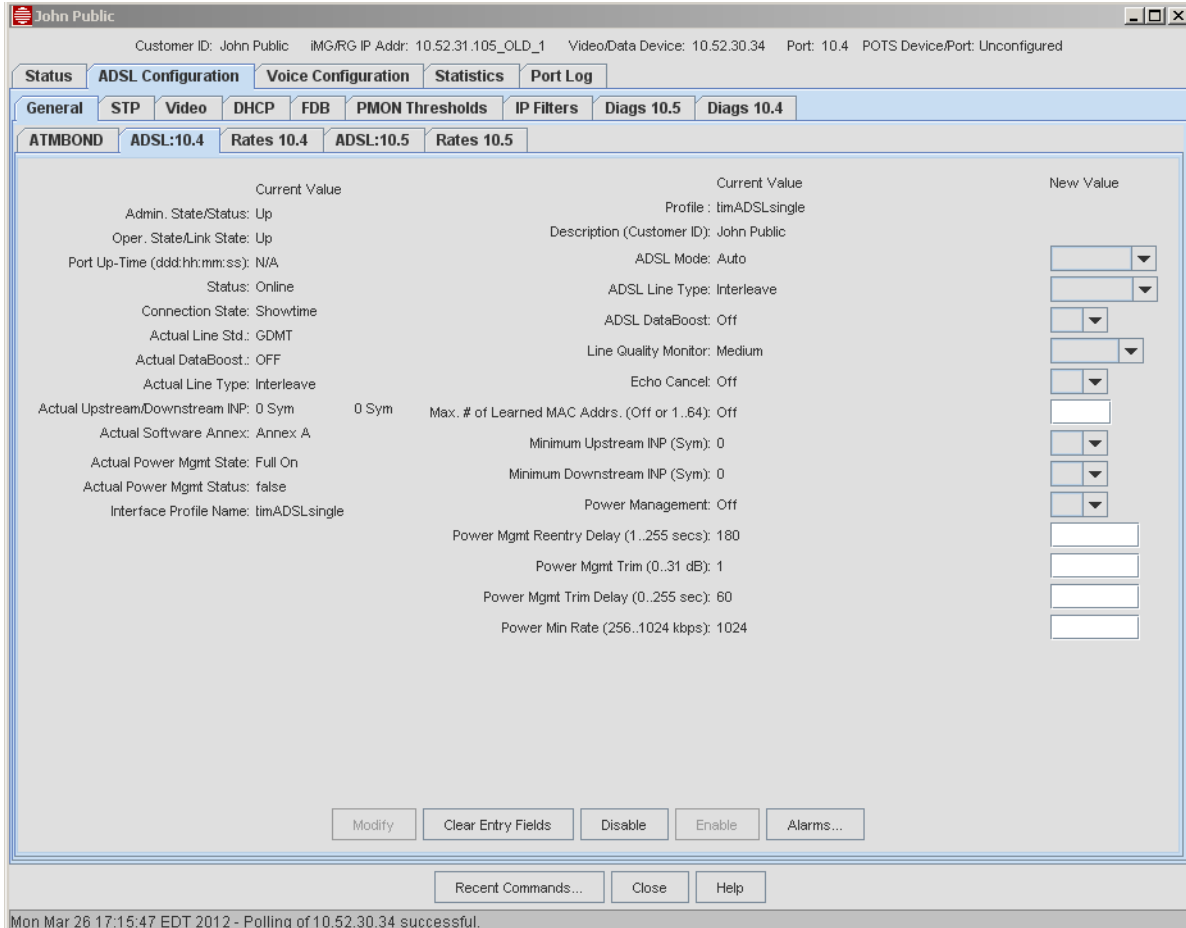

FIGURE 5-152 ADSL General Tab with ATM Bond Attributes

Each ADSL port has its own general tab and rates tab. The values for the Profile name and Customer ID are from the Triple_play provisioning form (refer to TBS). Some fields that appear on a regular ADSL port's general tab are moved to the ATMBOND tab since they are tied to the Bond rather than the port.

For more information on the configuration options for the Bonding and the Disable (Bond) and Remove Port options, refer to Figure 5.6.31.

Refer to the following



figu Mon Mar 26 17:15:47 EDT 2012 - Polling of 10.52.30.34 successful.

FIGURE 5-153 ADSL General Tab with ATM Bond - Single Port Attributes

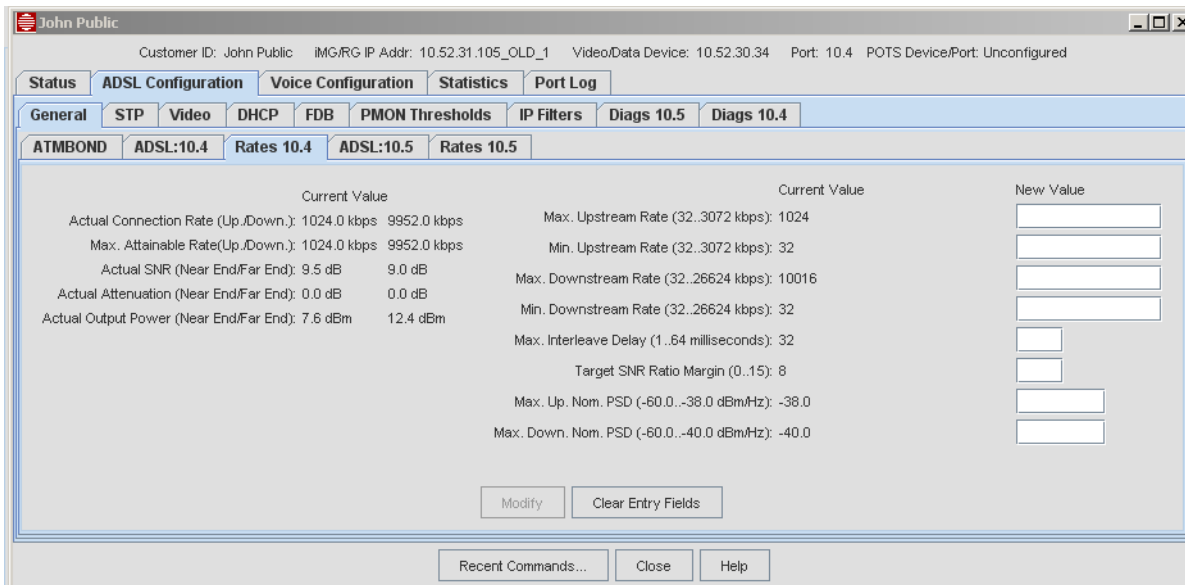

FIGURE 5-154 ADSL General Tab with ATM Bond - Single Port Rate Attributes

5.6.17.4 ADSL Configuration Tab - VCs/VLANs

The ability to correlate the port to Virtual Channels (VCs) and then the VC to one or more VLANs is configured through this tab.

Note: The ADSL16 and ADSL8S cards allow up to four VCs to be configured per port, while the ADSL24 card allows only one VC per port. The ADSL24A/B card supports 4 VCs.

Figure 5-160 shows the ADSL statistics once they have been enabled.

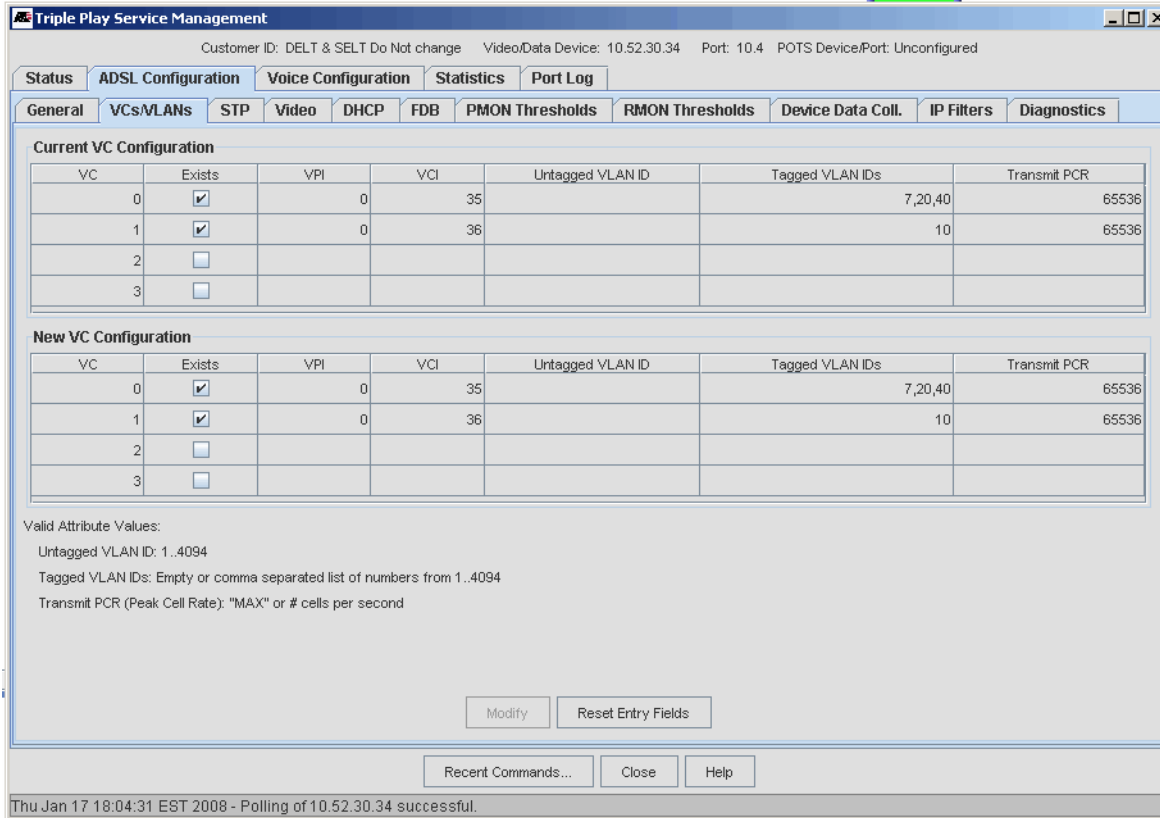

FIGURE 5-155 ADSL Configuration Form - VC/VLANs Tab

TABLE 5-37 View Details Form, VCs/VLANs Tab

Field/Button	Description
Current VC Configuration	The current values for all attributes of the VC configuration. These fields are view-only.
New VC Configuration	Initially this has a copy of the current configuration, but the fields are editable. The best strategy to fill in a new VC is to click on the Exists tic box and the appropriate values for the other columns are filled in.
Valid Attribute Values	Guidelines for valid attributes values or ranges.
Modify	Makes the changes made in the New VC Configuration Fields. Error messages appear if there are any invalid values.
Reset Changes	Reverts to the current VC configuration.

5.6.17.5 ADSL Video Tab

Refer to 5.6.30.

5.6.17.6 ADSL Configuration Tab - DHCP Tab

Refer to 5.6.28.

5.6.17.7 ADSL Configuration Tab - FDB Tab

Refer to 5.6.29.

5.6.17.8 ADSL Configuration Tab - PMON Thresholds Tab

Selecting the **PMON Thresholds** tab brings up a form (Figure 5-156) that allows thresholds to be set for the ATU-C and ATU-R statistics. When a threshold is crossed, an ADSL Port Log occurs, which will appear in the ADSL Port Log tab, and that is the only time the alert is produced during the 15 minute or 24 -hour period. Also, the device sends a trap, which is processed by Alarm Management so that an alarm is displayed.

Customer ID: DELT & SELT Do Not change Video/Data Device: 10.52.30.34 Port: 10.4 POTS Device/Port: Unconfigured

ADSL Configuration Voice Configuration Statistics Port Log

General VCs/MLANs STP Video DHCP FDB **PMON Thresholds** RMON Thresholds Device Data Coll. IP Filters Diagnostics

ATU-C Thresholds		ATU-R Thresholds	
	Current Value	New Value	
ATU-C 15 Min LOFs (0..900):	0	<input type="text"/>	ATU-R 15 Min LOFs (0..900):
ATU-C 15 Min LOSs (0..900):	0	<input type="text"/>	ATU-R 15 Min LOSs (0..900):
ATU-C 15 Min LOLs (0..900):	0	<input type="text"/>	ATU-R 15 Min LPRs (0..900):
ATU-C 15 Min LPRs (0..900):	0	<input type="text"/>	ATU-R 15 Min ESs (0..900):
ATU-C 15 Min ESs (0..900):	0	<input type="text"/>	
ATU-C 15 Min Failed Fast R:	0	<input type="text"/>	
ATU-C 15 Min SesL (0..900):	0	<input type="text"/>	
ATU-C 15 Min UasL (0..900):	0	<input type="text"/>	

Modify Clear Entry Fields

Recent Commands... Close Help

Thu Jan 17 18:06:52 EST 2008 - Polling of 10.52.30.34 successful.

FIGURE 5-156 ADSL Configuration Form - PMON Thresholds Tab

The threshold values can be modified by typing in new values in each field as needed and then clicking **Modify**.

For ADSL Bonding, PMON statistics can be collected for each Interface. RMONs are tied to the Bond interface. Refer to the following figure.

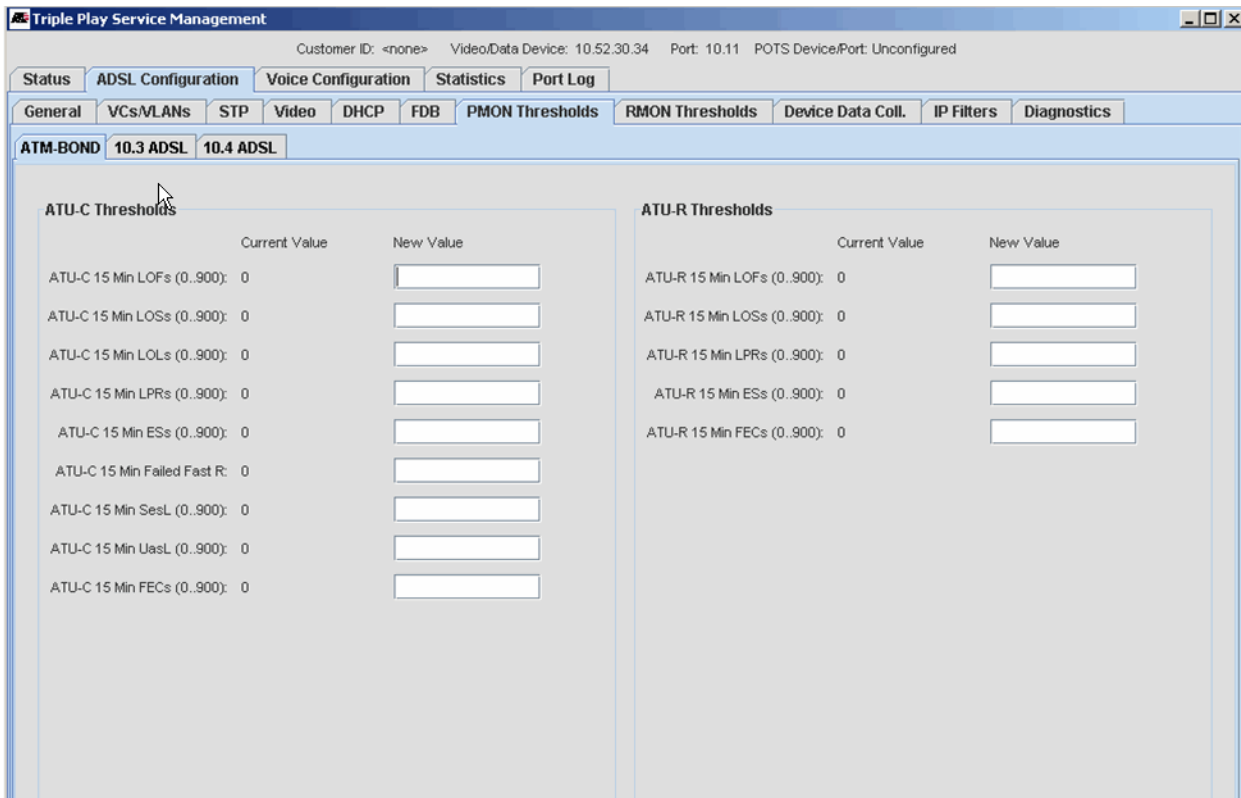

FIGURE 5-157 ADSL Bonding - PMON Thresholds

5.6.17.9 ADSL Configuration Tab - Device Data Collection Tab

The Device Data Collection form is a way to configure buckets that will collect statistics and the interval at which they are filled.

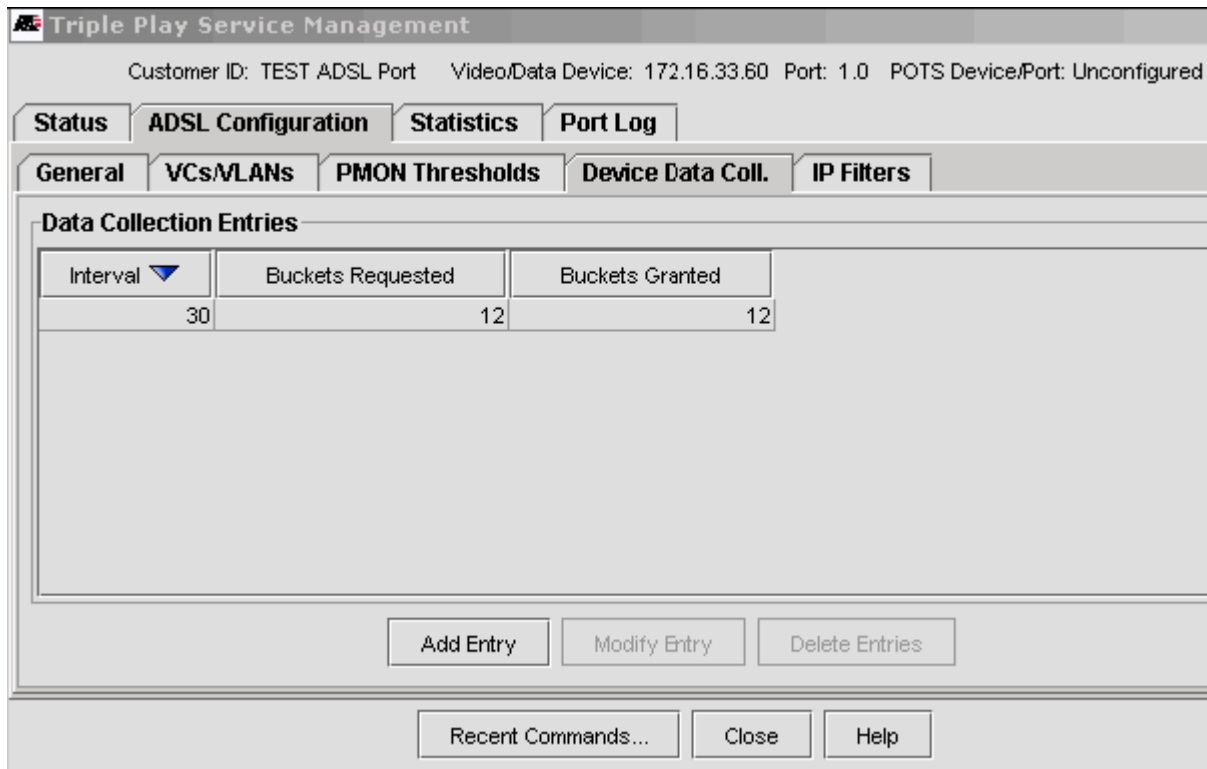

FIGURE 5-158 ADSL Configuration Form - Device Data Coll. Tab

The Add History brings up a form that allows the user to enter the number of buckets to be configured and at what interval (in seconds).

5.6.17.10 ADSL Configuration Tab - IP Filters

Incoming data to the ADSL ports (the ingress ports) can be filtered by IP address or a range of IP addresses. Figure 5-159 shows the IP Filters tab, while Table 5-38 shows the buttons and fields available. Refer to the iMAP User Guide for details.

Triple Play Service Management
Customer ID: TEST ADSL Port Video/Data Device: 172.16.33.60 Port: 1.0 POTS Device/Port: Unconfigured

Status | **ADSL Configuration** | Statistics | Port Log

General | VCs/MLANs | PMON Thresholds | Device Data Coll. | **IP Filters**

Port IP Filters

"Remove" or New IP Addr/Mask (e.g. 192.4.1.0/255.255.255.0)

Allowed Range #1:

Allowed Range #2:

Allowed Range #3:

Allowed Range #4:

Allowed Range #5:

Allowed Range #6:

Other Classifiers

Rank ▼	Classifier Name	Field Match(es)	Action(s)
69	telesyn_default_video	IPDEST= MULTICAST	SETVPRIORITY=4

Port IP Filter Counters

Match Count: N/A
Filter Count: N/A
Policed Count: N/A

Modify IP Filters
Add Classifier
Delete Classifier
Reset Counters

Recent Commands...
Close
Help

FIGURE 5-159 ADSL Configuration Form - IP Filters Tab

TABLE 5-38 IP Filters Form

Field/Button	Description
Port IP Filters	<p>Rank - Also called precedence, it is the rank a precedence a classifier has in a port. The highest rank is 1, and then in descending order. IP Filtering should have a precedence of 51-69.</p> <p>Classifier Name - This is the name given to the grouping of IP addresses or range of addresses.</p> <p>Field Match(es) - The range of IPSOURCE addresses is specified as a subnet and a mask.</p> <p>Action(s) -Perform actions when the incoming packet address matches what is set in the classifier:</p> <ul style="list-style-type: none"> - DROP - Discard the packet. - FORWARD - Allow the packet to be forwarded. - COUNT starts the counting of the actions (DROP or FORWARD) for the classifier(s).
Port IP Counters	<p>Match Count</p> <p>Filter Count</p> <p>Policed Count</p>
Add Classifier	<p>Associates a classifier with a port and give it a precedence.</p> <p><i>Note: A port cannot have more than one rank number, even if the rank numbers belong to different classifiers.</i></p>
Delete Classifier	Delete the classifier for the port.
Reset Counters	Reset all the counters on the port to 0.

5.6.17.11 ADSL Statistics Tab - Overview

Performance Management is the collection of traffic statistics over the interfaces (usually ports) over a specified time period (called the interval). Thresholds can be set so that if the value for a certain statistic crosses a threshold value, a log or alarm is produced.

5.6.17.12 ADSL Statistics Tab - PMON Stats Tab

Figure 5-160 shows the PMON Stats form.

*Note: By default, ports are disabled for statistics and must be explicitly enabled. (Selecting the **Enable Statistics** button on the ADSL Statistics tab form will invoke a table of all statistics, while selecting the **Disable Statistics** button will delete the table.*

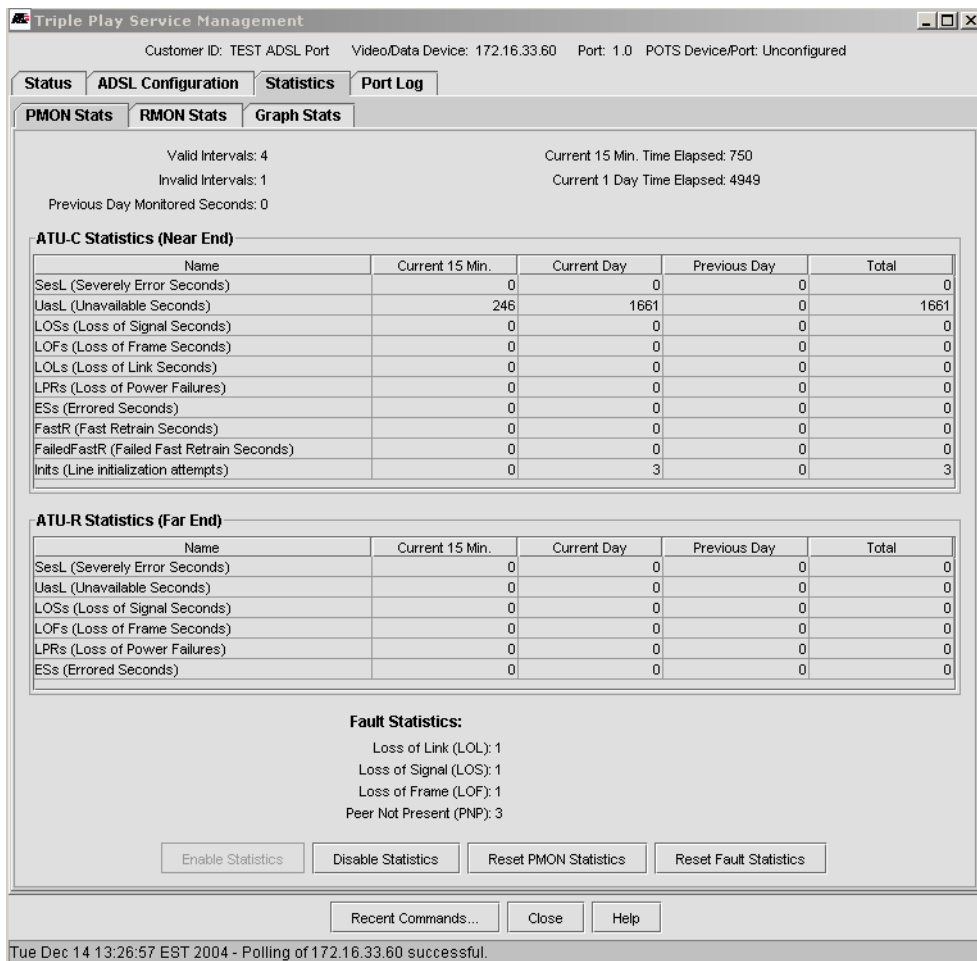

FIGURE 5-160 ADSL Statistics Form - PMON Stats Tab

The ATU-C and ATU-R statistics have the following measurements:

- Valid Intervals
- Invalid Intervals
- Previous Day Monitored Seconds
- Current 15 min. Time Elapsed
- Current 1 Day Time Elapsed

The table for each statistic type gives the count for the periods.

The Fault Statistics are counters, which are part of the ATN Enterprise MIB, that help to monitor the ADSL port by incrementing continuously until reset. By doing this, the history of certain events can be shown over time in order to obtain a more accurate view of what is happening with the ADSL port.

No management logs are produced with these counters, since they are cumulative, and so logs are produced for each individual event.

These counters can be reset to 0 by selecting **Reset Fault Statistics**.

Refer to the iMAP User Guide for details about these counters.

For ADSL Bonding, PMON statistics can be collected for each Interface. Refer to the following figure.

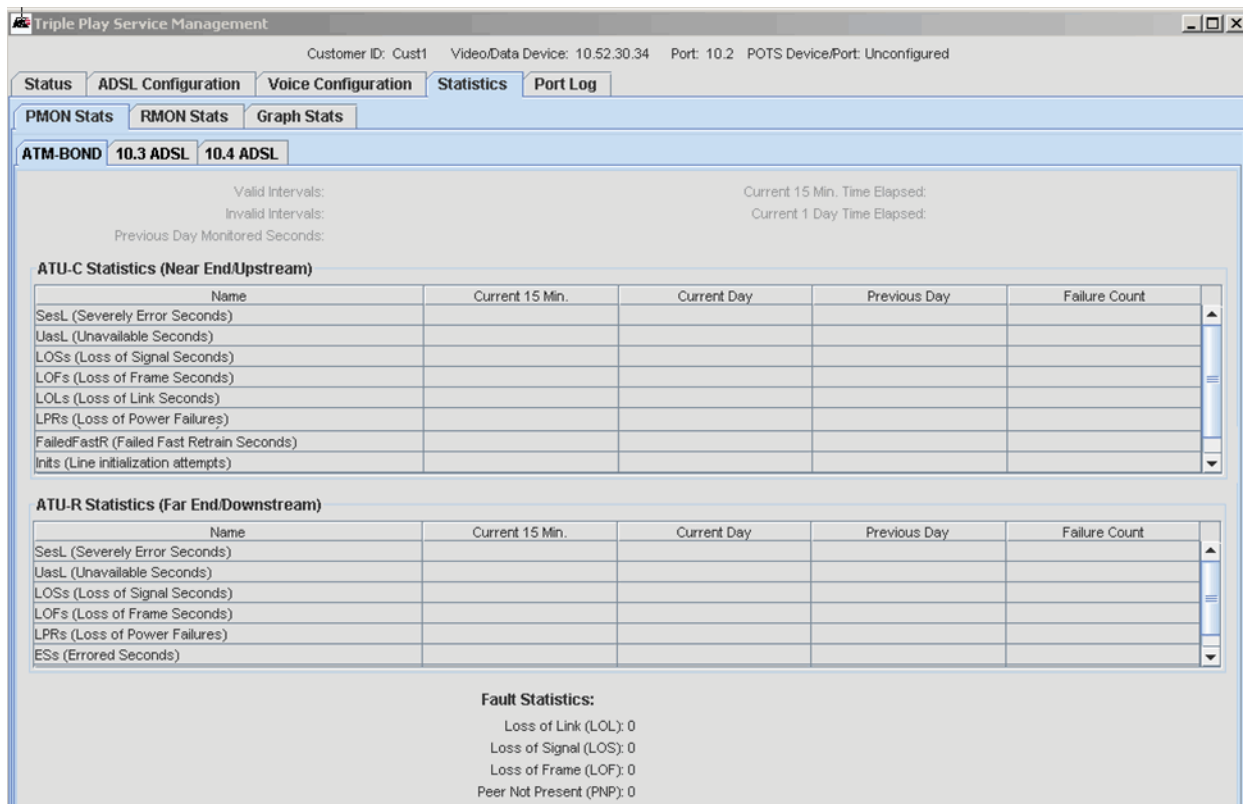

FIGURE 5-161 PMON Stats - ADSL Bonding

5.6.17.13 ADSL Statistics Tab - RMON Stats

RMON Statistics deal with packet flows and highlight errors as well as overflows of packets.

The QOS Statistics are counters for each priority queue that allow the user to see the ratio of sent versus dropped packets. These are cumulative and so produce no management logs.

These counters can be reset to 0 by selecting **Reset QOS Statistics**.

Refer to the iMAP User Guide for details about these counters.

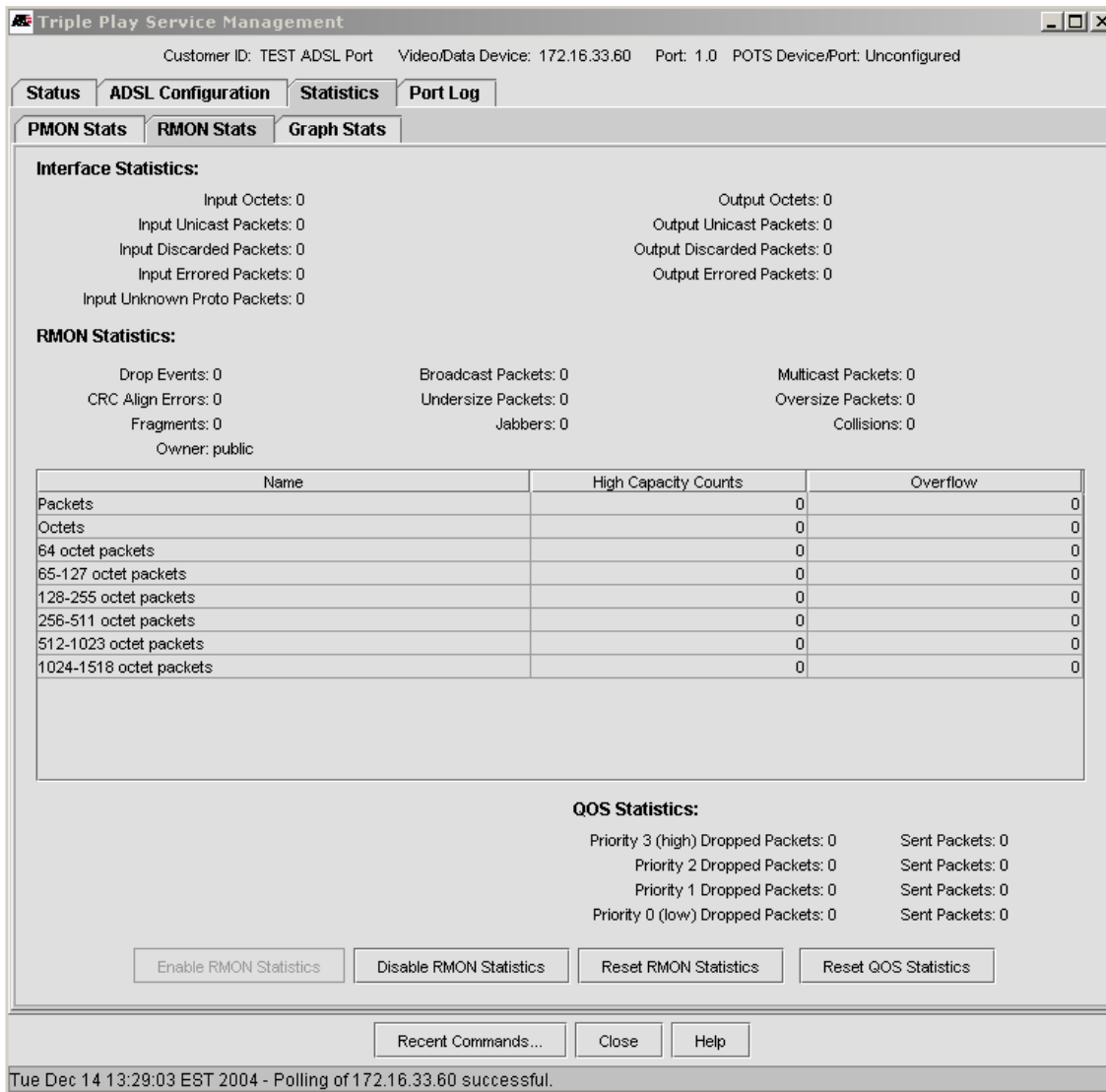

FIGURE 5-162 ADSL Statistics Form - RMON Stats Tab

TABLE 5-39 View Details Form, RMON Stats Tab

Field/Button	Description
Interface Statistics	Counts of input and output octets as well as errored input and output packets.
RMON Statistics	RMON error statistics
QOS Statistics	Shows the number of packets sent and dropped for each queue.
Enable RMON Statistics	If disabled, enables the statistics
Disable RMON Statistics	If enabled, disables the statistics

TABLE 5-39 View Details Form, RMON Stats Tab (Continued)

Field/Button	Description
Reset RMON Statistics	Resets the RMON statistics to 0.
Reset QOS Statistics	Resets the QOS statistics to 0.

5.6.17.14 ADSL Statistics Tab - Graph Stats

Once the statistics have been enabled, they can be graphed both in real-time and for statistics that have been collected. The polling interval (in seconds) can be changed, and up to six statistics (each shown in a different color) can be shown at once, as shown in Figure 5-163.

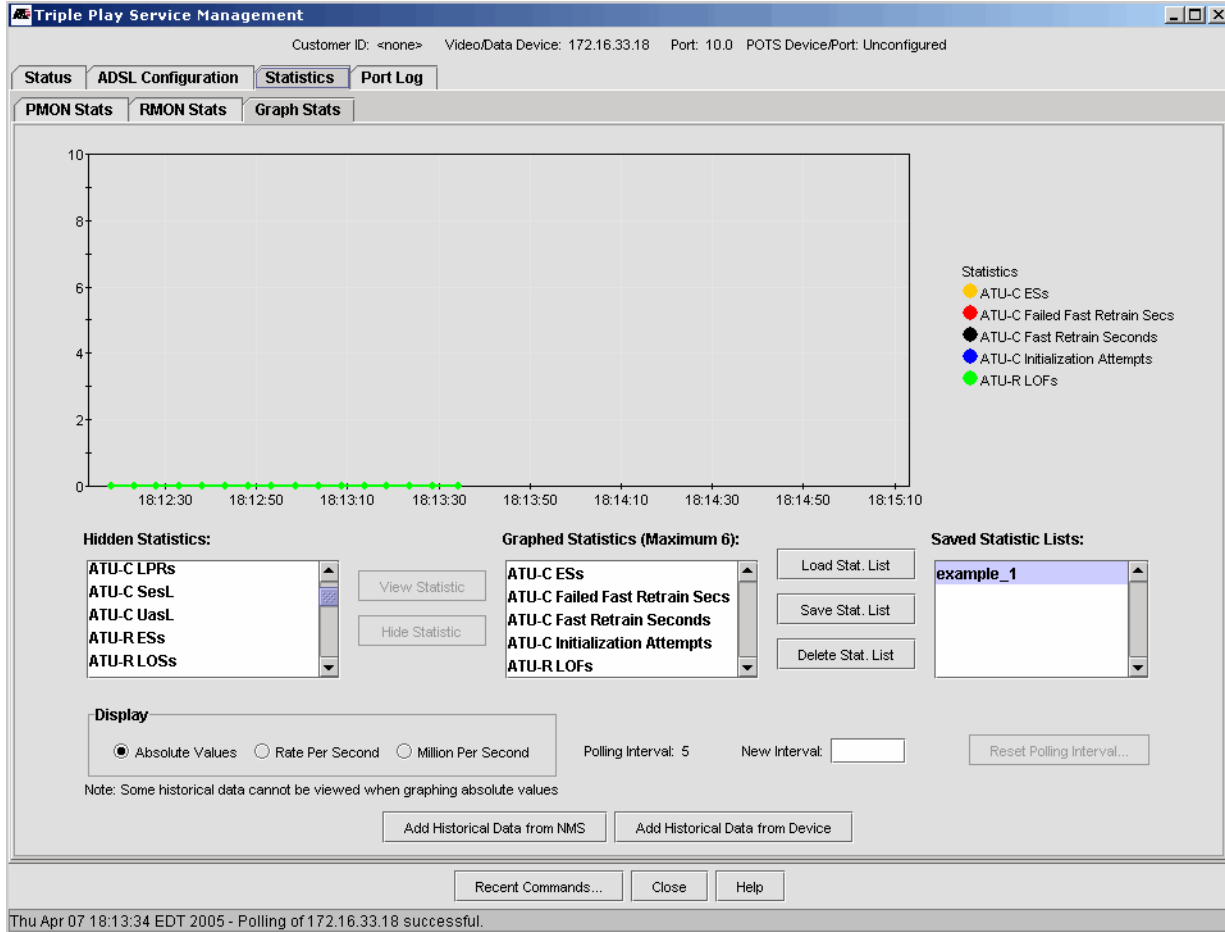

FIGURE 5-163 ADSL Statistics Form - Graph Stats Tab

Table 5-40 lists the buttons and fields available.

TABLE 5-40 ADSL Statistics Form - Graph Stats Tab

Field/Button	Description
Hidden Statistics	These are all the ATU-C and ATU-R statistics; form this set the ones to display are chosen.
Graphed Statistics	These are the ATU-C and ATU-R statistics that are currently displayed.
Polling Interval	This is the current polling interval, in seconds.

TABLE 5-40 ADSL Statistics Form - Graph Stats Tab (Continued)

Field/Button	Description
New Interval	This is used when changing the polling interval. When a new one is entered, the Reset Polling Interval Button is enabled, to allow the interval to be changed.
Add Historical Data from NMS	Include ADSL data that has been previously saved on the NMS
Add Historical Data from Device	Include ADSL data that has been previously saved from the historical data (buckets) of the device
Save Stat. List	Take a snapshot of the statistics chosen. A window appears to input a name.
Load Stat. List	Load a previously saved statistic list
Delete Stat. List	Delete a statistic list that is chosen in the Saved Statistics List panel

5.6.17.15 ADSL Port - Port Log Tab

Selecting the **Port Log** tab invokes a table that lists all the port-related management logs that have been generated. Refer to Figure 5-164.

For a description of management logs and the meaning of fields, refer to the iMAP Log / Troubleshooting Manual.

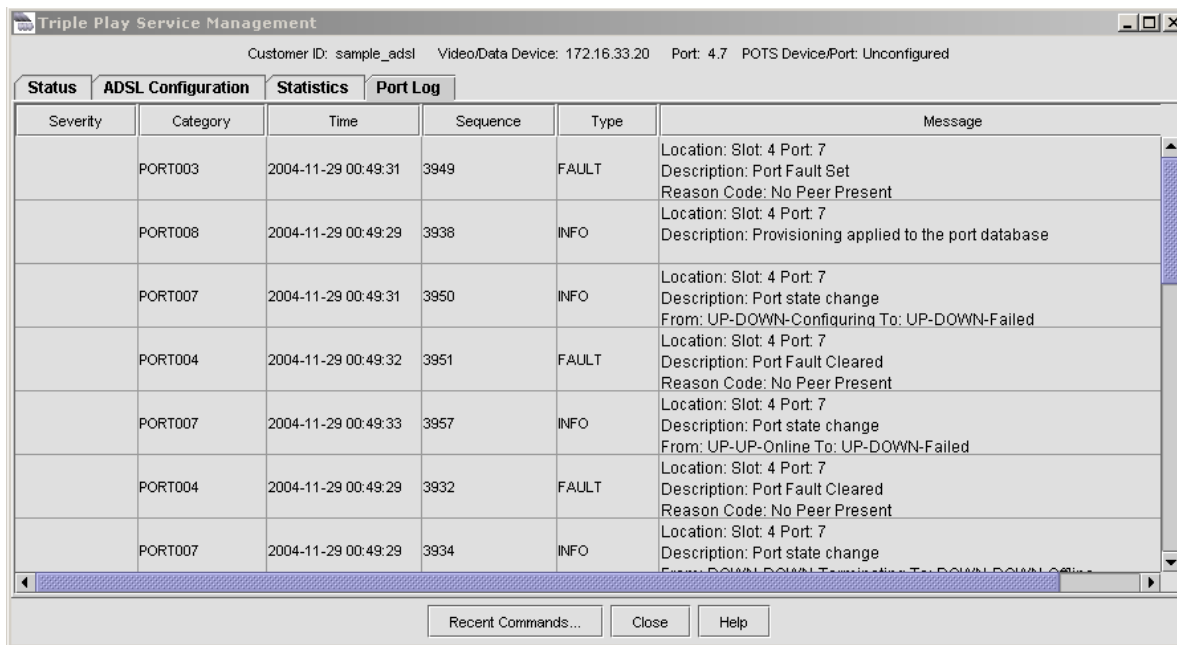

FIGURE 5-164 View Details Form (ADSL Port Log Tab)

5.6.18 SHDSL Port Management Form

Many of the SHDSL forms are similar to the ADSL forms. This subsection will focus on the differences; if forms or fields are the same, there is a reference to the appropriate ADSL subsection.

Note: There are changes to the GUIs if the SHDSL card is in Bonded (4-wire) mode.

Caution: Also, the card must be disabled when changing from 2-wire to 4-wire or vice-versa, so all provisioning information (i.e. Triple Play) is lost and must be re-provisioned.

5.6.18.1 SHDSL Port (Status Tab)

This tab is essentially the same as the ADSL Status tab, with the Video/Data Port, Voice, and Alerts panels. Since SHDSL is a high-speed data application, only the Voice/Data Port panel has information.

5.6.18.2 SHDSL Configuration Tab - Overview

The SHDSL Configuration tab has the following forms:

- General
- VCs/VLANs
- Video
- DHCP
- FDB
- PMON Thresholds
- Device Data Collection
- IP Filters

5.6.18.3 SHDSL Configuration Tab - General

The screenshot displays the 'SHDSL Configuration' window for a device with Customer ID 821-7861 and Video/Data Device 172.16.33.20. The 'General' tab is active, showing the following configuration details:

Current Value	New Value
Admin State/Status: Up	Profile: None
Oper State/Link State: Up	Description (Customer ID): 821-7861
Status: Online	Max. Rate (72.2312 Kbps): 2312
Connection State: Showtime	Min. Rate (72.2312 Kbps): 72
Actual Connect Rate: 2312.0 kbps	Target SNR Margin (0.10): 5
Actual Receiver Gain: 18.0 dB	Line Quality Monitor: Low
Actual SNR (STU-R): 0.0 dB	VPI (0.255): 0
Actual Attenuation (STU-C): 0.0 dB	VCI (32.65535): 35
Actual Attenuation (STU-R): 0.0 dB	MAC Learn Limit (Off/r1.64): OFF
Actual Output Power (STU-C): 0.5 dBm	
Actual Output Power (STU-R): 0.0 dBm	
PSD Mask: Symmetric PSD	
Tip Ring Configuration: Normal	

Buttons at the bottom include: Modify, Disable, Enable, Alarms..., Clear Entry Fields, Recent Commands..., Close, and Help.

Footer: Thu Apr 07 11:12:44 EDT 2005 - Polling of 172.16.33.20 successful.

FIGURE 5-165 SHDSL Configuration Tab - General - Normal

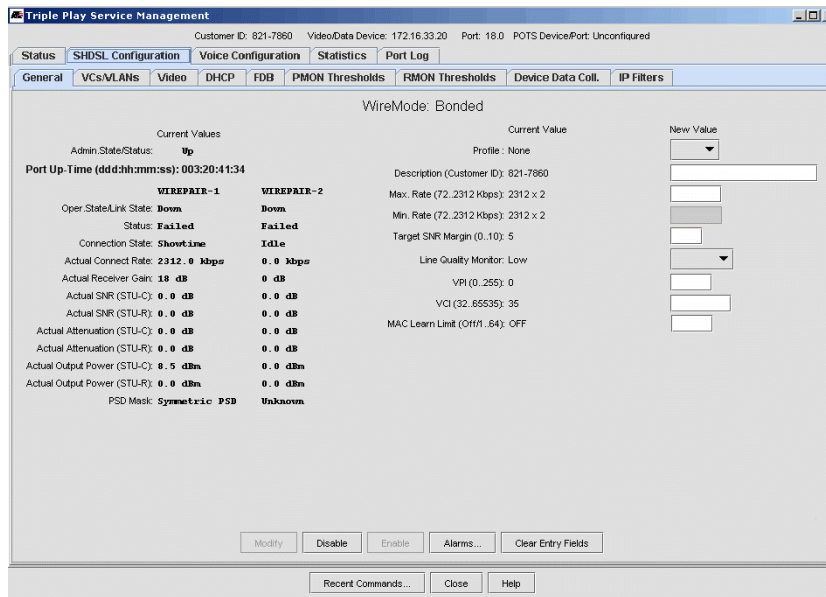

FIGURE 5-166 SHDSL Configuration Tab - General - Bonded

TABLE 5-41 SHDSL Configuration Tab - General

Field/Button	Description
WireMode	Whether the port is 2-wire (Normal) or 4-wire (Bonded)
Admin. State/Status	The Administrative State can be controlled and determines the Operational State. Refer to 5.5.24. For a bonded pair, the Admin State determines the Oper. State of both wire pairs.
Oper. State/Link State	The ability of the port to provide service. The Administrative State must be up and then the system determines if the port can provide service. It is possible, in a bonded configuration, that one wire pair will be Up while the other pair is Down. The line can still provide service, although at a lower rate. The user should check for events/logs and fix the problem.
Port Up-Time	Amount of time the physical interface has been in the UP-UP-Online state.
Status	The status of the port that follows from the Administrative State and Operational State. For meanings, refer to the iMAP User Guide, Section 4 <ul style="list-style-type: none"> - ONLINE - IN TEST - FAILED - OFFLINE - DEPENDENCY - DEGRADED - NOT INSTALLED - INITIALIZATION REQUIRED - TERMINATING
Wire Mode	Normal (2-wire) or Bonded (4-wire)
Connection State	The connection state, such as Idle or Showtime
Actual Connect Rate	The data rate that was actually attained.

TABLE 5-41 SHDSL Configuration Tab - General

Field/Button	Description
Actual Receiver Gain	Receiver Gain in db.
Actual SNR (STU-C, STU-R)	The signal-noise ratios that were actually attained.
Actual Attenuation (STU-C, STU-R)	The attenuation that was actually attained.
Actual Output Power (STU-C, STU-R)	The power outputs that were actually attained
PSD Mask	PSD (Power Spectral Density) is a measure of how power in a signal changes over frequency, and is expressed in dBms per Hz bandwidth. Values for SHDSL16 are: Symmetric Region 1 (Annex-A) Symmetric Region 2 (Annex-B)
Tip Ring Configuration	Values are Normal and Reversed
Profile	Which profile is being used (AutoProv or none, which uses default values).
Description (Customer ID)	An ID that can be given to uniquely identify the port. In most cases, the subscriber's telephone number is used.
Max. Rate	The maximum upstream rate that is provisioned.
Min. Rate	The minimum upstream rate that is provisioned.
Target SNR Margin	Specifies the target signal-to-noise ratio (in dB) to achieve on an ADSL port.
Line Quality Monitor	Specifies the ADSL line type as per ITU G.992. Allowed values are FAST and INTER-LEAVE, although FAST is not allowed if the MODE is GLITE. Refer to the iMAP User's Guide, Section 4.
VPI	Specifies the value for the ATM virtual path identifier on an ADSL port. Refer to the iMAP User's Guide, Section 4.
VCI	Specifies the value for the ATM virtual channel identifier on an ADSL port. Refer to the iMAP User's Guide, Section 4.
MAC Learn Limit	Depending on feature provisioning, the number of MAC addresses that can be learned (or Off)
Modify	Enabled when a value in New Value field has been entered, modifies the attributes according to the updated values. There is an error message if a value is invalid.
Enable	Enabled if the port is in an Administrative State of DOWN, enables the port and so brings the Administrative State to UP. If possible (for example, the ADSL card must be enabled), the Operational State will change to UP.
Disable	Enabled if the port is in an Administrative State of UP, disables the port and so brings the Administrative State to DOWN. The Operational State will also change to DOWN.
Alarms	Invokes the Alarm table of the Fault Management Object.

5.6.18.4 SHDSL Configuration Tab - VCs/VLANs

Note: The ADSL16 and ADSL8S cards allow up to four VCs to be configured per port, while the ADSL24 card allows only one VC per port. The ADSL24A/B card supports 4 VCs.

Refer to 5.6.17.4.

5.6.18.5 SHDSL Configuration Tab - Video Tab

This screen has the same attributes as for ADSL. Refer to 5.6.30

5.6.18.6 SHDSL Configuration Tab - DHCP Tab

Refer to 5.6.28.

5.6.18.7 SHDSL Configuration Tab - FDB Tab

Refer to 5.6.29.

5.6.18.8 SHDSL Configuration Tab - PMON Thresholds

This form shows (any) threshold values for the STU-C/R statistics.

Note: The thresholds are set for both the STU-C and STU-R at the same time and cannot be set separately.

5.6.18.9 SHDSL Configuration Tab - Device Data Collection

The Device Data Coll form has the same functions as the ADSL form as explained in 5.6.17.9

5.6.18.10 SHDSL Configuration Tab - IP Filters

The IP Filters form has the same functions as the ADSL form as explained in 5.6.17.10

5.6.18.11 SHDSL Statistics Tab - PMON Stats

The PMON Stats form is similar to the ADSL form except for the following:

- The statistics are the standard ones defined in RC3276. (STU-C and STU-R).
- There is no history of statistics (no previous day)
- If the port is bonded, each statistics column has Wire Pair-1 and Wire Pair-2 to show statistics for each pair.

5.6.18.12 SHDSL Statistics Tab - RMON Stats

The RMON Stats form has the same functions as the ADSL form as explained in 5.6.17.13. For a bonded pair, these statistics treat the bonded pair as one wire.

5.6.18.13 SHDSL Statistics Tab - Graph Stats

The Stats Graph form has the same functions as the ADSL form as explained in 5.6.17.14. For a bonded pair, the STU-C and STU-R have WP-1 and WP-2 so the user can display these for each statistic.

5.6.18.14 SHDSL Statistics Tab - Port Log

The Port Log form has the same functions as the ADSL form as explained in 5.6.17.15

5.6.19 Voice Port Management (Tabbed Form)**5.6.19.1 POTS24 Configuration Tab - Overview**

When the POTS 24 is configured (as part of a customer configuration that includes analog voice), this service management form provides all the relevant data.

Note: When an iMG/RG is configured for voice service using the GenBand, information about this configuration is shown in the Voice Configuration tab. Refer to Section 7.

5.6.19.2 POTS24 Configuration Tab - Status

This form is similar to other port types, and lists the POTS attributes as well as Alerts

Triple Play Service Management

Customer ID: 555-1313 Video/Data Device/Port: Unconfigured POTS Device: 172.16.33.13 Port: 6.7

Video/Data Port Configuration

No Video/Data Port Configured

Voice Configuration

POTS:

Device Name: 172.16.33.13	Device Alarm Summary: 1/1/1/0
Card IP Address: 10.10.10.10	Card Status: UP-UP-Degraded
Slot.Port: 6.7	Card Alarm Summary: 0/0/1/0
	Port Status: UP-UP-Online
	Port Alarm Summary: 0/0/0/0

POTS Call Agent: Unconfigured Device Alarm Summary: 0/0/0/0

IG-CRV: Line Status:

Derived Voice:
No Derived Voice Lines Configured

Alerts

Status	Failure Object	Alarm Message	Date/Time
Minor	172.16.33.13;atnCardFault-38_Slot6	Card alarm indication on device - 172.16.33.13, ...	Nov 27, 2004 06:15:30 PM
Critical	172.16.33.13;atnShelfFault-4	Alarm indication on device - 172.16.33.13, Shelf...	Nov 28, 2004 06:25:55 PM
Major	172.16.33.13	Node failure. This probably means one or more ...	Nov 28, 2004 06:25:55 PM

FIGURE 5-167 POTS24 Configuration Tab - Status

5.6.19.3 POTS24 Voice Configuration Tab - POTS

Each port on the POTS24 provides an analog interface to a physical customer loop. Configurable attributes for each line interface specify the capabilities of the line that affect analog waveform transmission and packetization of the analog waveform. Differences between the SIP versus MGCP protocol parameters are noted in the table below.

Note: The Voice Configuration tab also shows information for the iMG/RG when the Derived Voice has been provisioned using the GenBand. Otherwise, there is the message "Derived voice gateway information is not available." This means that the NMS does not manage the device that provides the service.

Caution: Modification of these attributes requires the port to be disabled.

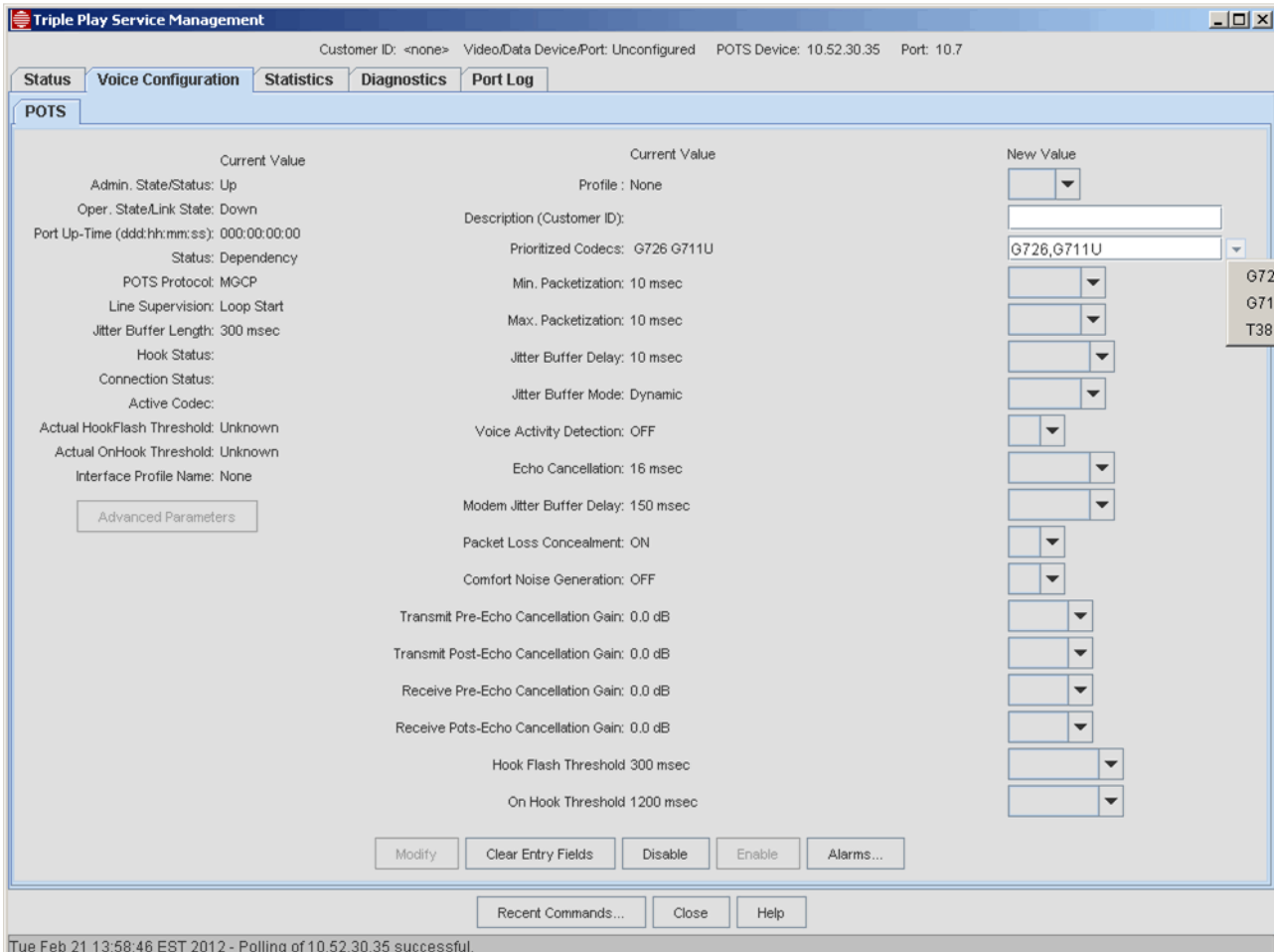

FIGURE 5-168 Example POTS24 Voice Configuration Tab - POTS (SIP Protocol)

TABLE 5-42 POTS24 Voice Configuration Tab - POTS

Field/Button	Description
Admin. State/Status:	The Administrative State can be controlled and determines the Operational State. Refer to 5.5.24.
Oper. State/Link State:	The ability of the port to provide service. The Administrative State must be up and then the system determines if the port can provide service.
Port Up-Time	Amount of time the physical interface has been in the UP-UP-Online state.

TABLE 5-42 POTS24 Voice Configuration Tab - POTS

Field/Button	Description
Status:	The status of the port that follows form the Administrative State and Operational State. For meanings, refer to the iMAP User Guide, Section 4. <ul style="list-style-type: none"> - ONLINE - IN TEST - FAILED - OFFLINE - DEPENDENCY - DEGRADED - NOT INSTALLED - INITIALIZATION REQUIRED - TERMINATING
POTS Protocol	Whether the card is using MGCP or SIP protocol
Profile:	Profile used that pre-populates many of the port attributes.
Description (Customer ID):	Customer ID for the port. Refer to 7.2.7 .
Prioritized Codecs	Specifies the Codec capabilities advertised to the Call Agent: <ul style="list-style-type: none"> - PCMU: G.711 mu law (specified in CCITT/ITU-T recommendation G.711) - G726-32: CCITT/ITU-T recommendation G.726 - T38 - Use this mode to digitize the media for reliable transmission over IP networks - All: all of the above <p><i>Note: Refer to the Release Notes for the iMAP product for details on T38 support.</i></p>
Min. Packetization:	The minimum number of milliseconds of voice data that can be encoded in a data packet. This value is advertised to the Call Agent. The default is 20 msec. <p><i>Note: To support Call Waiting with Caller ID, this attribute should be set to 10 milliseconds.</i></p>
Max. Packetization	The maximum number of milliseconds of voice data that can be encoded in a data packet. This value is advertised to the Call Agent. The default is 20 msec. <p><i>Note: To support Call Waiting with Caller ID, this attribute should be set to 10 milliseconds</i></p>
Jitter Buffer Delay:	Used with jitter buffering, this is the amount of time that the first packet is delayed. This delay is then used to smooth out jitter on subsequent arrivals. The default is 30 msec
Jitter Buffer Mode:	The jitter buffer mode. A jitter buffer is used to compensate for the jitter in packet arrival and out-of-order packets. A large jitter buffer causes increase in the delay and decreases the packet loss. A small jitter buffer decreases the delay but increases the packet loss. <p>DYNAMIC - This mode minimizes delays and is the default.</p>
Voice Activity Detection:	Specifies whether to advertise Voice Activity Detection (VAD) capability to the Call Agent. VAD is used for silence suppression, and will reduce the transmission rate during inactive speech periods while maintaining an acceptable level of output quality. <p>ON: VAD is supported. This is the default</p>
Echo Cancellation:	Echo Cancellation in ms for period capability is advertised to the Call Agent.

TABLE 5-42 POTS24 Voice Configuration Tab - POTS

Field/Button	Description
Modem Jitter Buffer Delay	Used with jitter buffering, this is the amount of time that the first packet is delayed. <i>Note: The default in release 8.0 was changed from 30ms to 10ms</i>
Packet Loss Concealment:	Specifies whether Packet Loss Concealment is enabled. Packet Loss Concealment is a technique used on the receive side of the voice packet stream to mask the effects of lost or discarded packets. If not used, users may report difficulty in understanding speech due to short gaps. Default is ON .
Comfort Noise Generation:	Specifies whether or not to generate Comfort Noise (RFC 3389). To generate background noise to fill silent gaps during calls if voice activity detection (VAD) is activated; The parameter should be ON .
Transmit Pre-Echo Cancellation Gain	The gain applied on the transmit side before echo cancellation is applied. Values are:-9.0 to +3.0
Transmit Post-Echo Cancellation Gain	The gain applied on the transmit side after echo cancellation is applied. Values are:-9.0 to +3.0
Receive Pre-Echo Cancellation Gain	The gain applied on the receive side before echo cancellation is applied. Values are:-9.0 to +3.
Sip User Name	This is used to identify the user and is usually a DN.
Sip Password	Used with the User Name to authenticate an endpoint to a server.
Sip Digit String	Has rules for how digits are parsed.
Sip Display Name	Name that appears on the display of the SIP-enabled VoIP device.
Modify	Enabled when a field has been entered or changed.
Disable	Disables the port, which must be done before attributes can be changed
Enable	Enables the port
Alarms	Brings up the Alarm view for the selected port.
Clear Entry Fields	Clears the writable fields of any values.

5.6.19.4 POTS24 Statistics Tab - POTS Stats

This tab lists the RTP statistics for the card. Refer to the iMAP User Guide for details.

5.6.19.5 POTS24 Statistics Tab - Graphs Stats

This window makes a graph of selected statistics and displays them with varying attributes. Refer to the following figure and table.

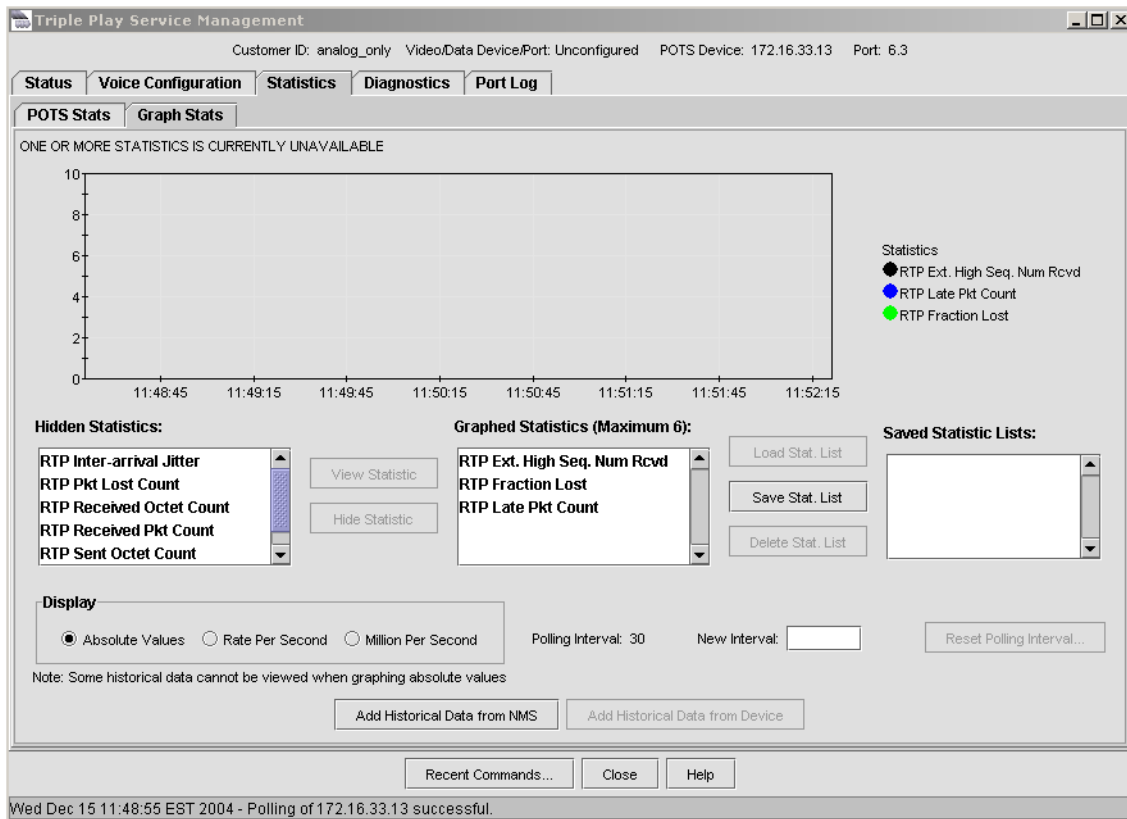

FIGURE 5-169 POTS24 Statistics Tab - Graphs Stats

TABLE 5-43 POTS24 Statistics Tab - Graphs Stats

Field/Button	Description
Hidden Statistics:	Statistics not added to the resulting graph
View Statistic:	Enabled when a statistic is chosen form Hidden Statistics, clicking this button adds it to the graph/
Hide Statistic:	Enabled when a statistic is chosen form Graphed Statistics, clicking this button deletes it from the graph/
Display	The attribute that controls the display: - Absolute Values - Rate Per Second - Million Per Second
Polling Interval:	Current Polling Interval in seconds
New Interval:	Sets a new interval for polling. This is set with the Reset Polling Interval button.
Enable Statistics	Enables the graph for the statistics chosen.
Disable Statistics:	Disables the graph
Add Historical Data from NMS:	Adds the data collected previously from NMS port management

5.6.19.6 POTS24 Diagnostics Tab - POTS

This form allows the user to run a set of diagnostics on the port interface. Refer to the following figure and table.

In iMAP release 12.0, additional diagnostic and testing support for POTS interfaces hosted by the POTS24 and PAC24 service modules was added:

- T/G, R/G, T/R capacitance measurements added to suite of measurements from “DIAGNOSE INTERFACE” function
- New CLI command for generation of a Toll grade defined metallic tone used for T/R identification

Refer to the iMAP User Guide for detailed information.

Following are the changes to the Diagnostics tab to support this feature.

A panel across the top on the Diagnostics tab shows port state information that applies to both Test Tone and Diagnostics functionality.

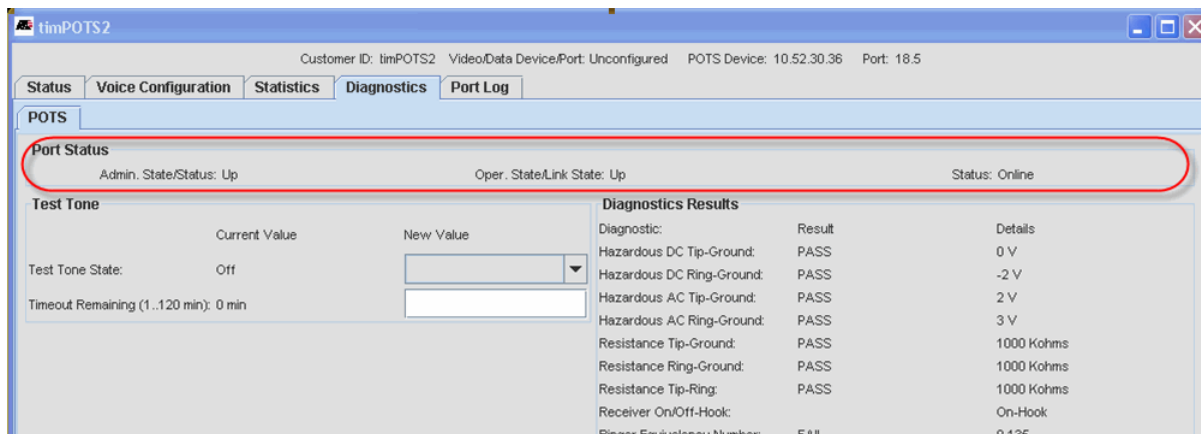

FIGURE 5-170 POTS24 Diagnostics Tab - Port Status

New rows have been added to the Diagnostics Results table to display the Capacitance test results and details/values.

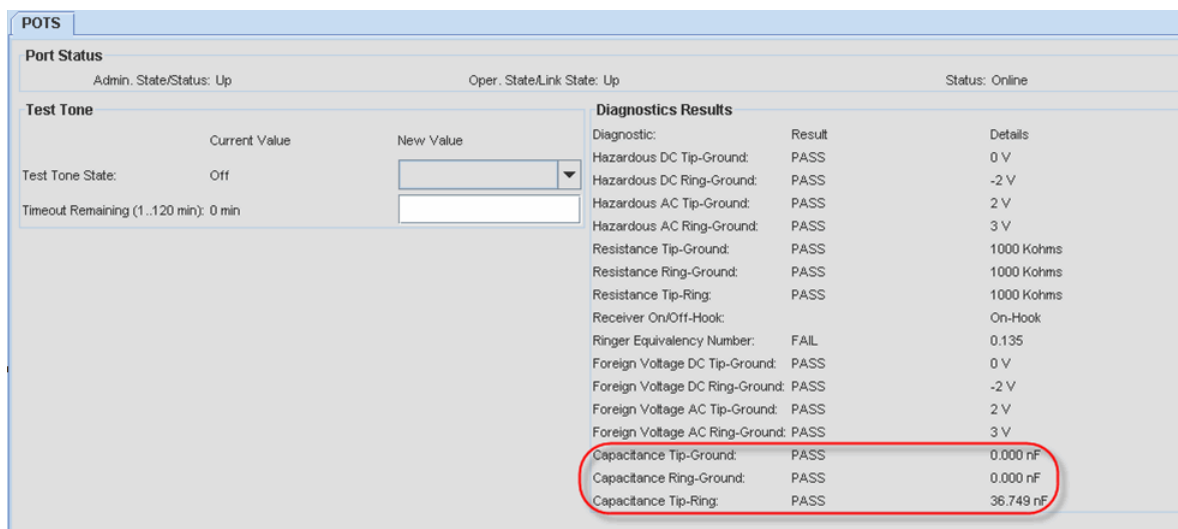

FIGURE 5-171 POTS24 Diagnostics Tab - Capacitance Test Results

A new panel has been added specifically for handling Test Tone information

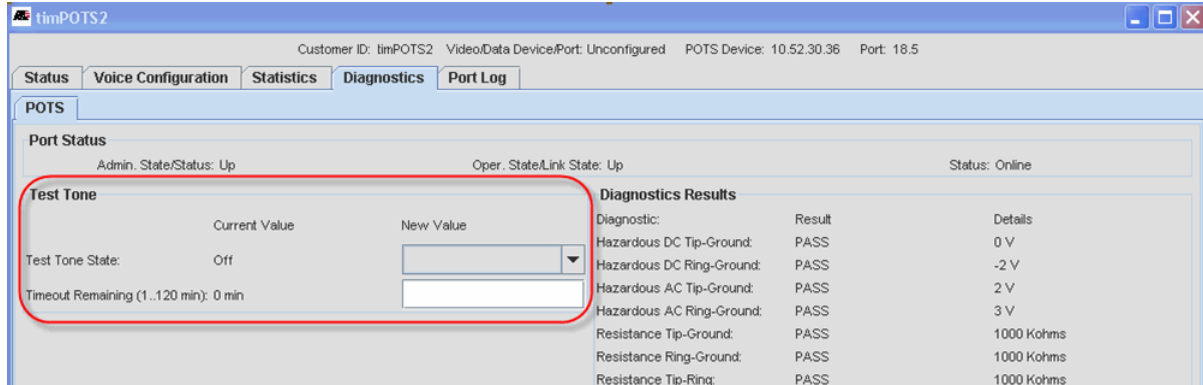

FIGURE 5-172 POTS24 Diagnostics Tab - Test Tone Information

The button Modify Test Tone is used when modifying the Test Tone information. Note that when turning the Test Tone status to On and making changes to the Time-out, there is a warning about service. Refer to the following figure.

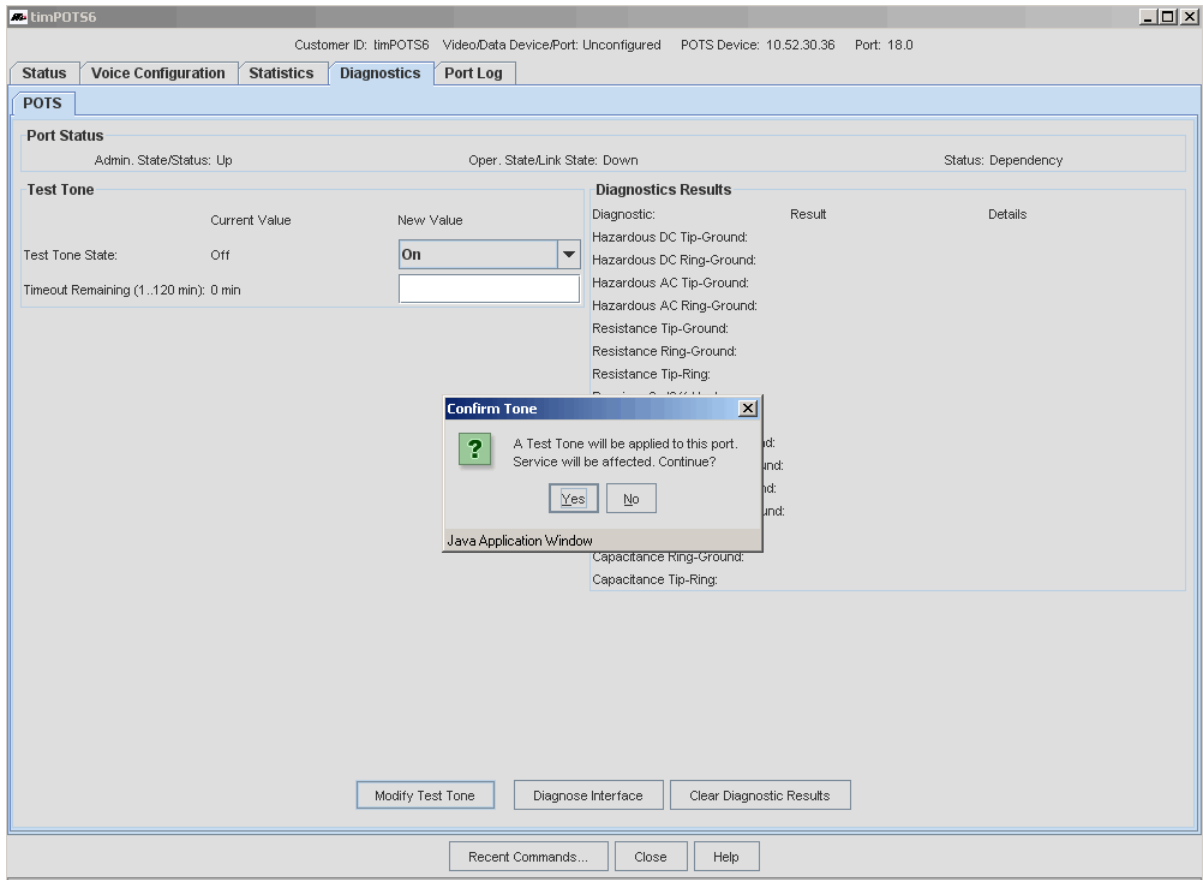

FIGURE 5-173 Modifying Test Tone Information

TABLE 5-44 POTS24 Diagnostics Tab - POTS

Field/Button	Description
Diagnostic Results	Refer to the iMAP User Guide for an explanation of these test functions.
Diagnostic: Result	For each test, there is a Result field that says PASS or FAIL and a Details field that gives the specific test result.
Modify Test Tone	For making changes to Test Tone settings. When changing state to ON, there is a service warning.
Diagnose Interface	This runs the diagnostics listed and gives the test results
Clear Diagnostic Results	Clears any previous diagnostic results

5.6.19.7 POTS Port (Port Log Tab)

Selecting the **Port Log** tab invokes a table that lists all the port-related management logs that have been generated. Refer to Figure 5-174. This window has the same columns as the ADSL Port Management window for Port Log.

For a description of management logs and the meaning of fields, refer to the iMAP Log / Troubleshooting Manual.

Severity	Category	Time	Sequence	Type	Message
	PORT007	2004-11-29 08:00:13	6349	INFO	Location: Slot: 6 Port: 7 Description: Port state change From: UP-DOWN-Dependency To: UP-DOWN-Configur
	PORT013	2004-11-29 08:00:14	6381	INFO	Location: Slot: 6 Port: 7 Description: Port Information Reason Code: Enabling Defect Monitoring
	PORT007	2004-11-29 08:00:14	6421	INFO	Location: Slot: 6 Port: 7 Description: Port state change From: UP-DOWN-Configuring To: UP-UP-Online
	PORT013	2004-11-29 08:00:14	6379	INFO	Location: Slot: 6 Port: 7 Description: Port Information Reason Code: Enabling Defect Monitoring

FIGURE 5-174 POTS Port (Port Log Tab)

5.6.20 CES8 Port (DS1/E1 Port Management Tabbed Form)

The DS1/E1 Port Management Form provides all the relevant information for both single and dual CES endpoints; when the port is part of a dual endpoint configuration, the port dynamically changes so that both endpoints appear in the form.

Note: Refer to 6.16 for a walk-through of provisioning a dual endpoint.

5.6.20.1 DS1/E1 Port Tab

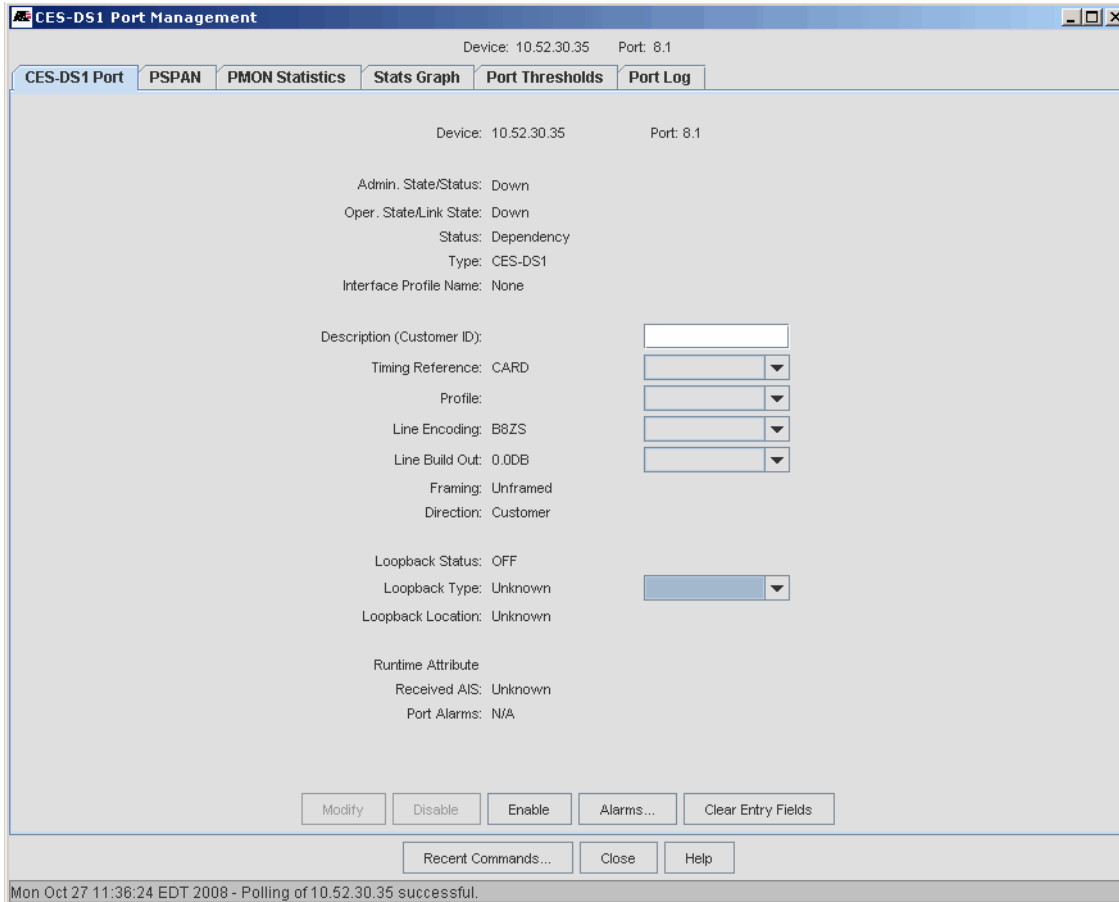

FIGURE 5-175 CES DS1 Port Tab (For E1, Label and Type are E1)

TABLE 5-45 CES DS1 Port Management - DS1 Port Tab

Field/Button	Description
Device: / Port:	Non-editable, this is the port (or ports) that are being displayed.
Admin. State/Status:	Administrative State of the port. This depends on the state of the associated card.
Oper. State/Link Status	Operational State of the port. This depends on the Administrative state of the port.
Status	The same attributes as for other cards
Type:	DS1 or E1
Interface Profile Name:	The port profile being used. This is the first editable field. <i>Note: A profile must have been previously created.</i>
Description (Customer ID)	If an active DS1 port, the customer ID that was assigned
Timing Reference	Where the port receives its clocking source from (SELF, CONNECTION, or CARD).
Profile	The profile that was created and applied.
Line Encoding	Either B8ZS or AMI (DS1), or AMI or HDB3 (E1). This should not be changed, unless the card is being re configured.
Line Build Out:	The line build out, either in db (long-haul) or feet (short-haul)

TABLE 5-45 CES DS1 Port Management - DS1 Port Tab

Field/Button	Description
Framing	Always Unframed, since that is the only type of CES currently supported.
Direction	Whether the DS1 interfaces a customer or the network.
Loop Back:	Whether to set the port for loopback, and if so either LINE or INWARD (This is normally done before putting the port in service. The DS1/E1 port is considered operationally DOWN when a loopback is configured, because no “thru service” can be provided. Therefore, when a loopback is configured on the interface, an administratively UP interface would be “UP-DOWN-Loopback”, while an administratively DOWN interface would be DOWN-DOWN-Loopback
Runtime Attribute	What the line is currently processing for alarms
Modify	If any values are changed, this button is enabled.
Disable / Enable	A toggle to enable (if disabled) or disable (if enabled) the port. If the user is disabling the port, there is a warning.
Alarms...	Goes to the Alarm window for the port.
Clear Entry Fields	If any values have been added, they are cleared (including pull-downs).

5.6.20.2 PSPAN Tab

The PSPAN tab form shows the attributes for the PSPAN that is associated with the port, and, in a dual endpoint configuration, the attributes for the peer PSPAN.

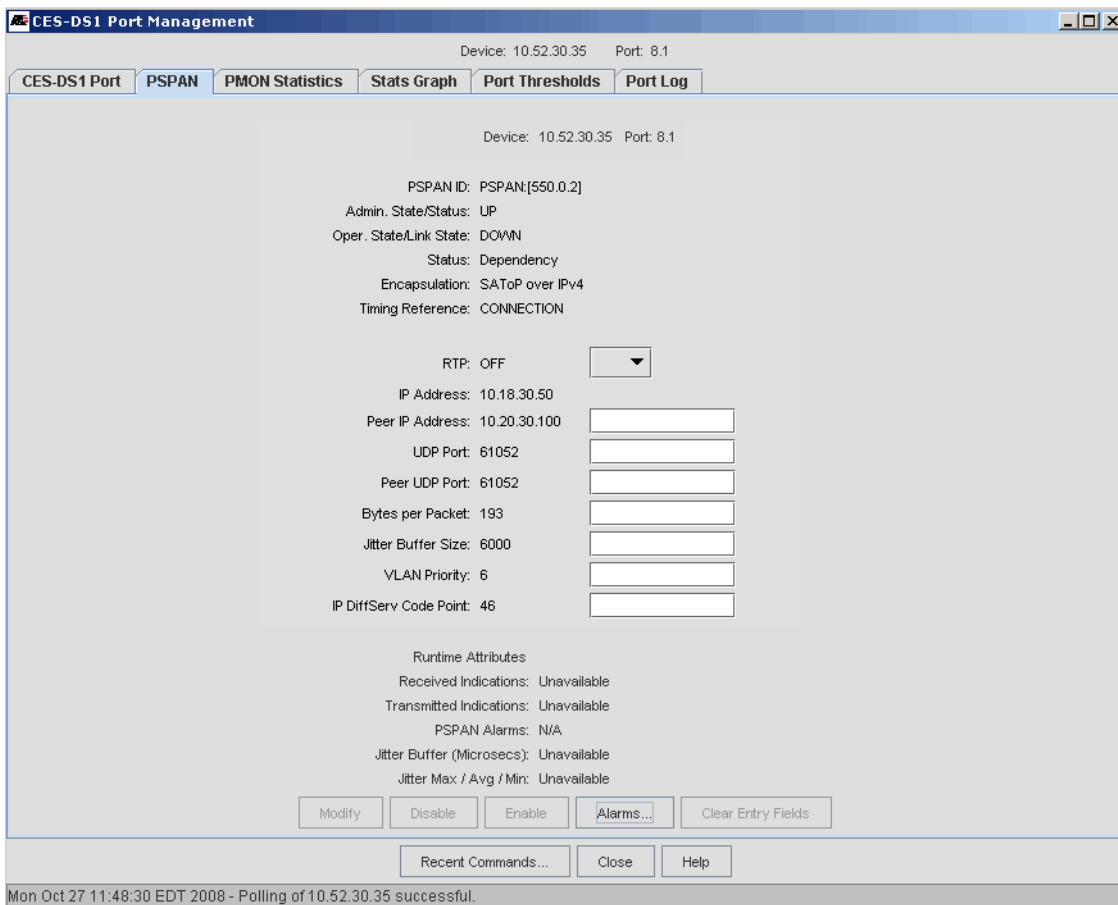

FIGURE 5-176 CES PSPAN Tab

TABLE 5-46 CES DS1 Port Management - PSPAN Tab

Field/Button	Description
PSPAN ID:	This ID is the format vlan:subinterface:pspanid. Note that the subinterface and psanid are provided by the AlliedView NMS as part of CES provisioning.
Admin. State/Status:	Administrative State of the PSPAN. This depends on the state of the associated port.
Oper. State/Link Status	Operational State of the PSPAN. This depends on the administrative state of the PSPAN.
Status	The status of the PSPAN
Encapsulation:	SAToP over IPv4. This is the only one used for release 5.0
Timing Reference:	Where the PSPAN receives its clocking source from (SELF, CONNECTION, or CARD).
RTP:	Real Time Protocol. RTP must be used if the PSPAN is being used as the timing reference. <i>Note: This must have the same setting for both sides of a connection.</i>
IP Address:	IP Address of the connection, In this release, it is for the CES8 card.
Peer IP Address:	The IP address for the other end of the connection. \ <i>Note: By filling in the peer values, the user is explicitly defining the connection; filling in the attributes for the port may define the port but does not actually set up the path through the network.</i>

TABLE 5-46 CES DS1 Port Management - PSPAN Tab

Field/Button	Description
UDP Port:	The UDP port for this end of the connection. This must be unique within an IP address on a card
Peer UDP Port:	The UDP at the other end of the connection.
Bytes per Packet:	The default is 193 for DS1, 256 for E1. <i>Note: Refer to 6.16 on how this is controlled in a dual configuration.</i>
Jitter Buffer Size:	The size of the jitter buffer.
VLAN Priority	The 802.1p priority bit setting.
IP DiffServ Code Point:	the DSCP (Differentiated Services Code Point) value
RunTime Attributes	The current status of the line.
Modify	If a value has been changed, this button is activated.
Disable / Enable	A toggle to enable (if disabled) or disable (if enabled) the PSPAN. If the user is disabling the PSPAN, there is a warning.
Alarms...	Goes to the Alarms window.
Clear Entry Fields	If any values have been added, they are cleared (including pull-downs).

5.6.20.3 PMON Statistics

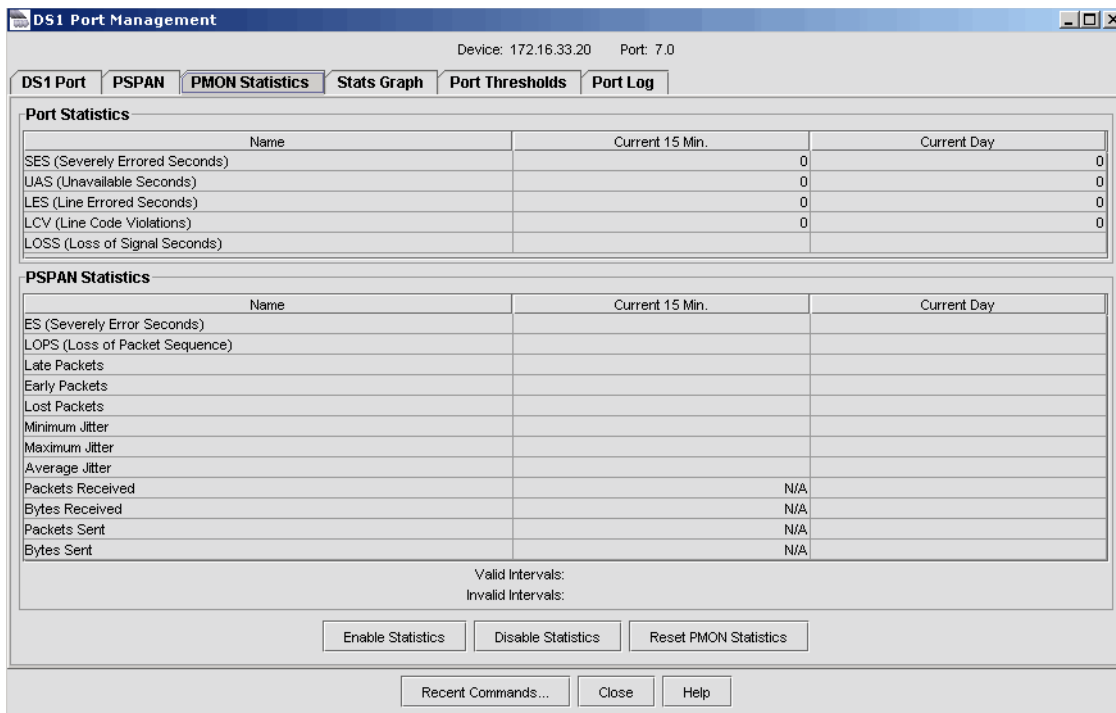

FIGURE 5-177 CES PMON Statistics Tab

- Enable Statistics - Activates all the statistics
- Disable Statistics - Deactivates all the statistics
- Reset Statistics - Sets all the statistics to 0

5.6.20.4 DS1 Port Management - Stats Graph Tab

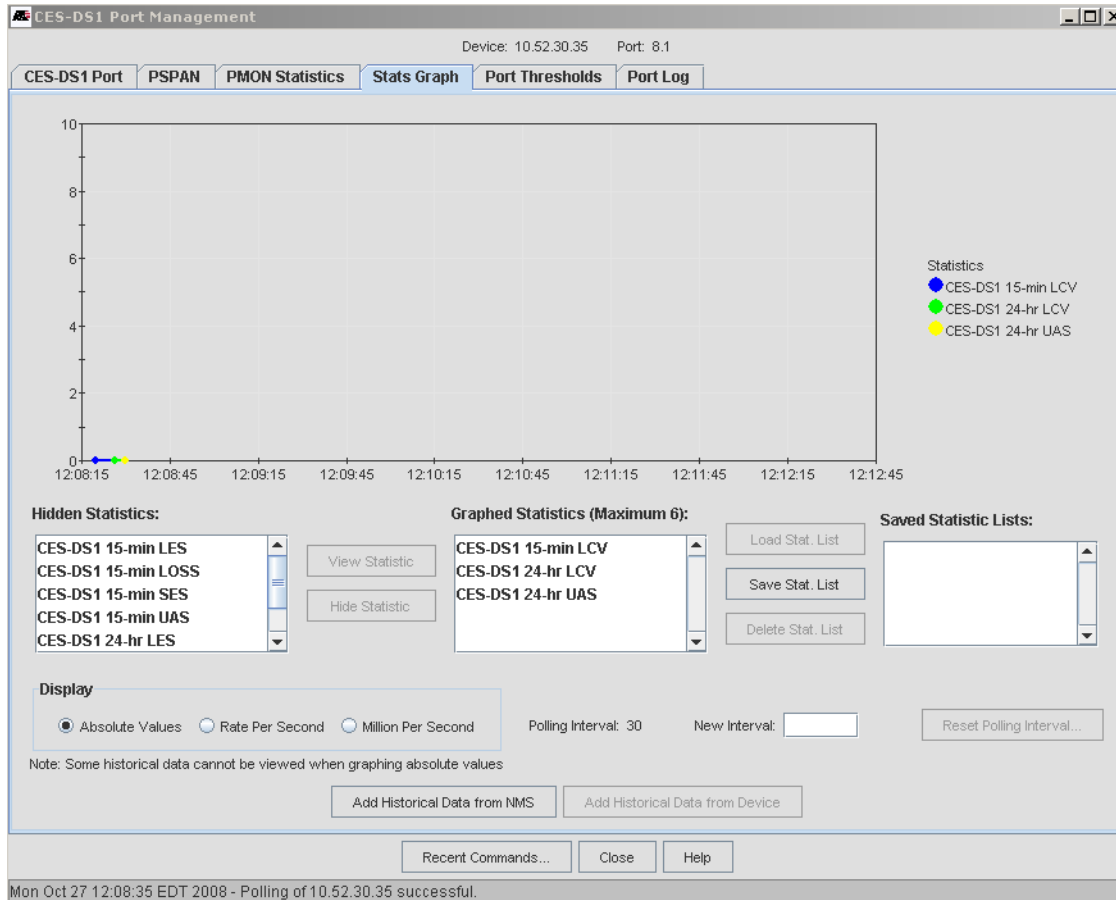

FIGURE 5-178 CES DS1 Port Management - Stats Graph Tab

TABLE 5-47 CES DS1 Port Management - Stats Graph Tab

Field/Button	Description
Hidden Statistics:	Statistics not added to the resulting graph
View Statistic:	Enabled when a statistic is chosen form Hidden Statistics, clicking this button adds it to the Graphed Statistics (Maximum of 6), which is the current list of statistics being graphed.
Hide Statistic:	Enabled when a statistic is chosen form Graphed Statistics, clicking this button deletes it from the Graphed Statistics/
Load Stat. List	After choosing one of the names from the Saved Statistic list, the user clicks on this button to make it the current Graphed Statistics
Save Stat. List	The user is prompted to save the current list with a name. Once saved, it is added to the Saved Statistics Lists.
Delete Stat. List	After choosing one of the names from the Saved Statistic list, the user clicks on this button to delete this name.

TABLE 5-47 CES DS1 Port Management - Stats Graph Tab

Field/Button	Description
Display	The attribute that controls the display: - Absolute Values - Rate Per Second - Million Per Second
Polling Interval:	The Current Polling Interval in seconds
New Interval:	Sets a new interval for polling. This is set with the Reset Polling Interval button.
Add Historical Data from NMS:	Adds the data collected previously from NMS Performance Management
Add Historical Data from Device:	Adds the data collected previously from the associated device.

5.6.20.5 DS1 Port Management - Port Thresholds Tab

This form allows the user to modify the threshold values for the DS1/E1 and PSPAN statistics. When a new value is entered in the New Value field, the Modify button is enabled.

Note: In most cases, these DS1/E1 values are not modified because they are part of the DS1/E1 port profile; if the user does change a value, the port is now out of sync with its associated profile, and "" will appear next to the Profile name on the DS1/E1 Port tab form (as well as the Port Inventory table). In the dual endpoint configuration, the "*" will appear next to the specific port where the values were changed from the Profile. To Resync the port, the user must re-apply the profile on the DS1/E1 tab form, which puts the values back to what they are in the Profile.*

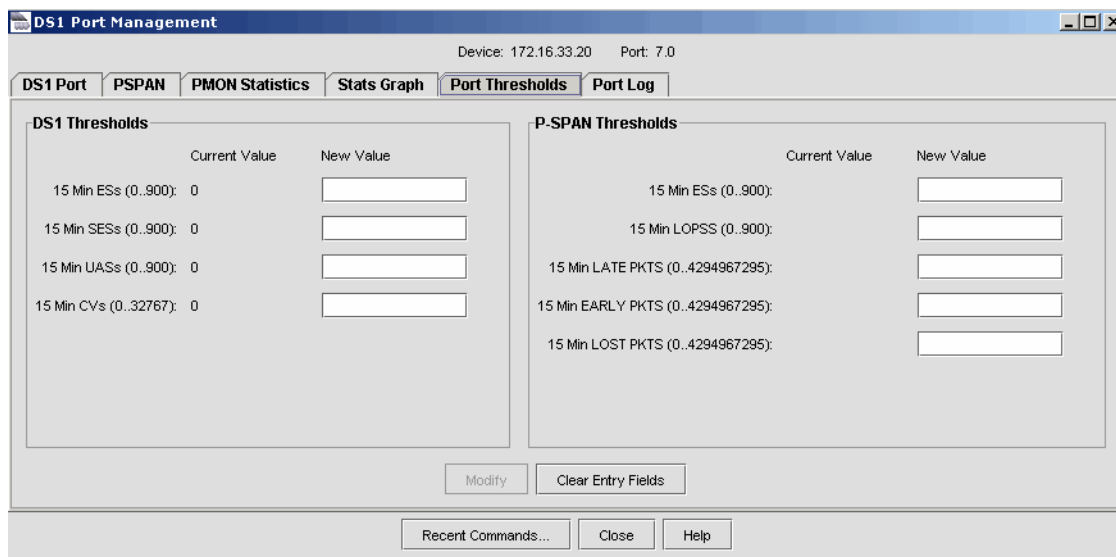

FIGURE 5-179 CES DS1 Port Management - Port Thresholds Tab

5.6.20.6 DS1 Port Management - Port Log Tab

This form lists the PORT logs associated with the port(s) and can therefore provide a history of provisioning as well as any errors or problems. Refer to the following figure.

Port	Severity	Category	Time	Sequence	Type	Message
7.0	**	PORT004	2004-12-01 13:38:28	4623	FAULT	Location: Slot 7 Port: 0 Description: Port Fault Cleared Reason Code: Loss Of Signal
7.0	**	PORT003	2004-12-01 13:38:31	4663	FAULT	Location: Slot 7 Port: 0 Description: Port Fault Set Reason Code: Loss Of Signal
7.0	**	PORT004	2004-12-01 13:38:59	4815	FAULT	Location: Slot 7 Port: 0 Description: Port Fault Cleared Reason Code: Loss Of Signal
7.0	**	PORT003	2004-12-01 13:39:02	4854	FAULT	Location: Slot 7 Port: 0 Description: Port Fault Set Reason Code: Loss Of Signal
7.0	**	PORT004	2004-12-01 13:40:24	5107	FAULT	Location: Slot 7 Port: 0 Description: Port Fault Cleared Reason Code: Loss Of Signal
7.0	**	PORT003	2004-12-01 13:40:27	5145	FAULT	Location: Slot 7 Port: 0 Description: Port Fault Set Reason Code: Loss Of Signal
5.0		PORT007	2004-12-01 13:37:37	4505	INFO	Location: Slot 5 Port: 0 Description: Port state change From: UP-DOWN-Dependency To: DOWN-DOWN-De
5.0		PORT008	2004-12-01 13:37:37	4507	INFO	Location: Slot 5 Port: 0 Description: Provisioning applied to the port database
5.0		PORT007	2004-12-01 13:37:37	4511	INFO	Location: Slot 5 Port: 0 Description: Port state change From: DOWN-DOWN-Dependency To: UP-DOWN-De

FIGURE 5-180 CES DS1 Port Management - Port Log Tab

5.6.21 NTE8 Port Management Form

The DS1/E1 Port Management Form for the NTE8 provides all the relevant information for both single and dual NTE8 endpoints; when the port is part of a dual endpoint configuration, the port dynamically changes so that both endpoints appear in the form.

Note: Refer to 6.17 for a walk-through of provisioning the near and far ends of an NTE8.

5.6.21.1 DS1/E1 Port Tab

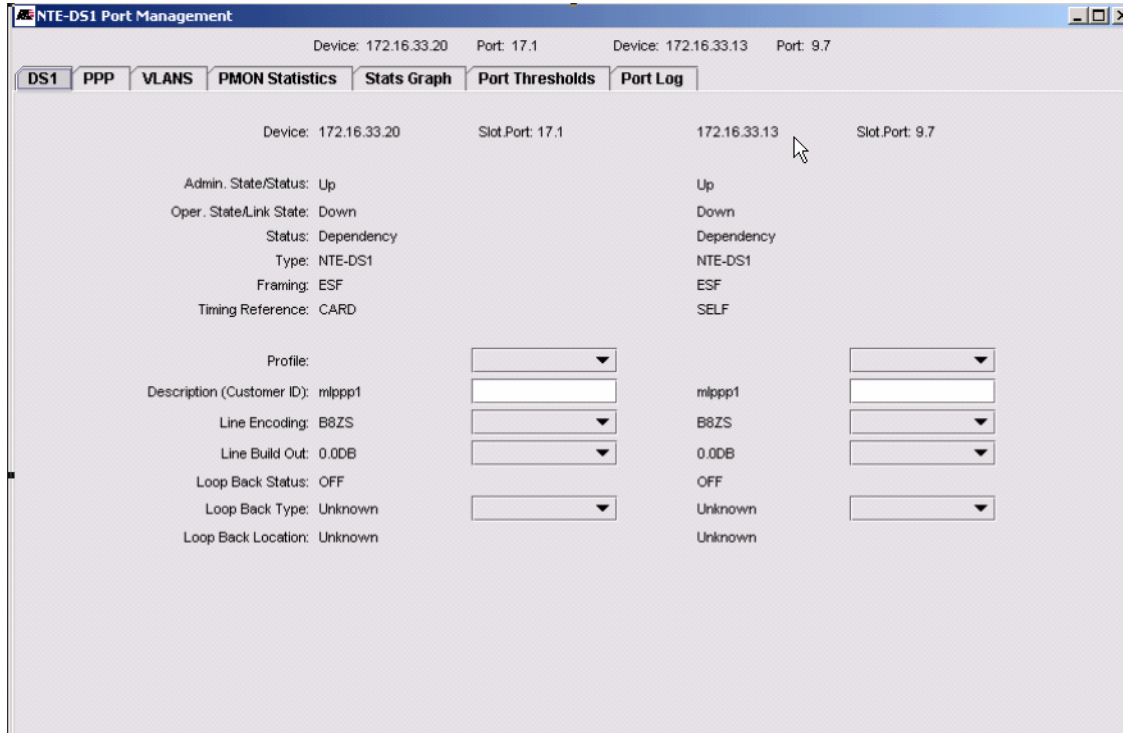

FIGURE 5-181 NTE DS1 Port Management Form - DS1/E1 Tab

TABLE 5-48 NTE DS1 Port Management - DS1 Port Tab

Field/Button	Description
Device: / Port:	Non-editable, this is the port (or ports) that are being displayed.
Admin. State/Status:	Administrative State of the port. This depends on the state of the associated card.
Oper. State/Link Status	Operational State of the port. This depends on the Administrative state of the port.
Status	The same attributes as for other cards
Type:	NTE-DS1 or NTE-E1
Framing	Always ESF
Timing Reference	Where the port receives its clocking source from (SELF or CARD).
Profile:	The port profile being used. This is the first editable field. <i>Note: A profile must have been previously created.</i>
Description	Where the user can add an appropriate description for what the port provides
Line Encoding	Either B8ZS (DS1) or HDB3 (E1). This should not be changed, unless the card is being re configured.
Line Build Out:	The line build out, either in db (long-haul) or feet (short-haul)

TABLE 5-48 NTE DS1 Port Management - DS1 Port Tab

Field/Button	Description
Loop Back Status	The DS1/E1 port is considered operationally DOWN when a loopback is configured, because no "thru service" can be provided. Therefore, when a loopback is configured on the interface, an administratively UP interface would be "UP-DOWN-Loopback", while an administratively DOWN interface would be "DOWN-DOWN-Loopback"
Loop Back Type	The types of loopback: - NONE - INWARD - Not supported for the NTE8 - LINE - The entire signal is looped from external equipment only through the DS1/E1 port.
Loop Back Location	
Modify	If any values are changed, this button is enabled.
Disable / Enable	A toggle to enable (if disabled) or disable (if enabled) the port. If the user is disabling the port, there is a warning.
Alarms...	Goes to the Alarm window for the port.
Clear Entry Fields	If any values have been added, they are cleared (including pull-downs).

5.6.21.2 PPP Tab

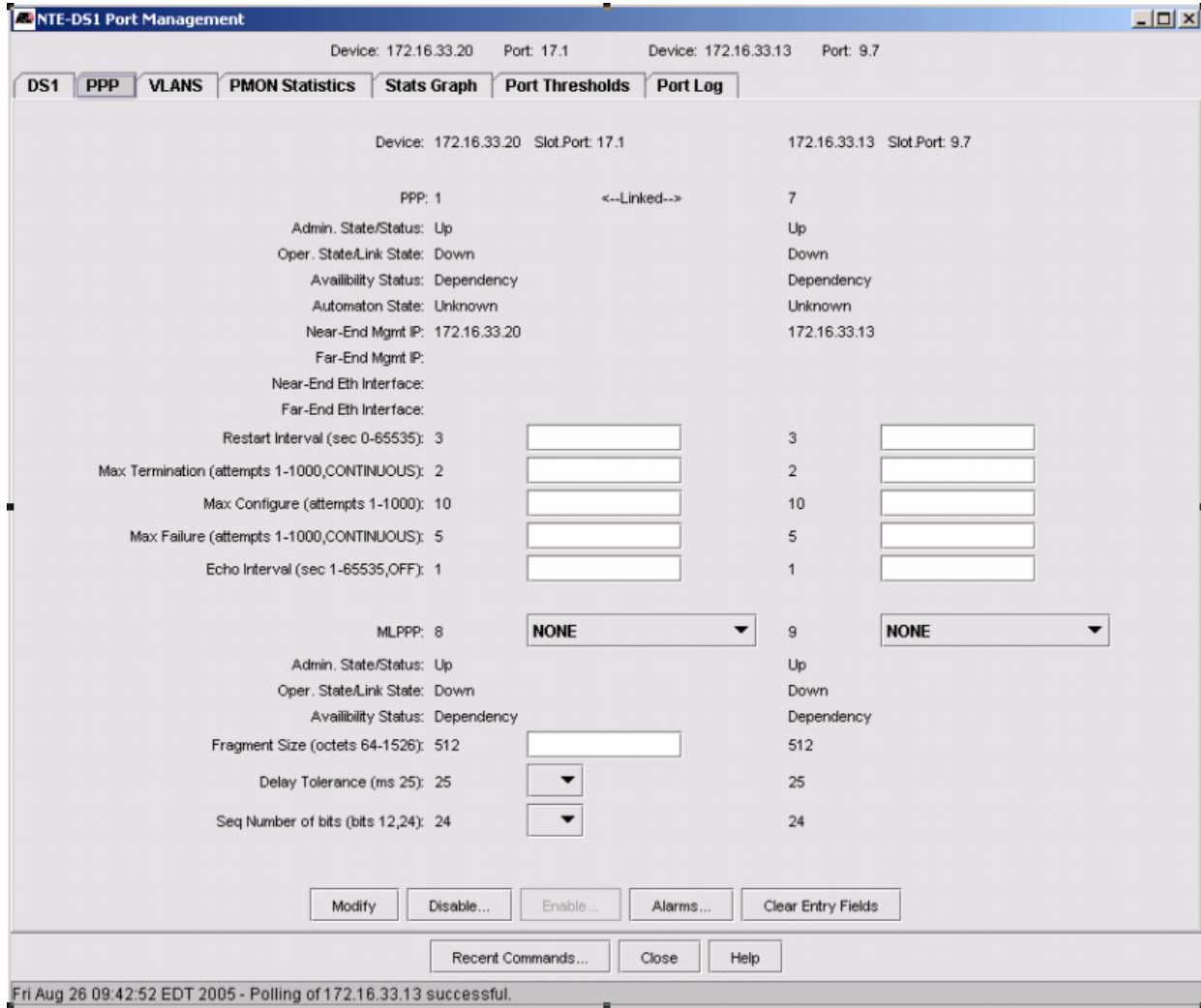

FIGURE 5-182 NTE DS1 Port Management Form - PPP Tab (Linked Connection)

For information on the parameters, refer to the iMAP User Guide.

5.6.21.3 Eth Interface Tab

This form has two sub-tabs, General and IpFilters.

The screenshot displays the 'NTE-DS1 Port Management' window with the 'Eth Interface' tab selected. The 'General' sub-tab is active. At the top, it shows 'Device: 172.16.33.18' and 'Port: 5.0'. Below this, a row of tabs includes 'DS1', 'PPP', 'Eth Interface', 'PMON Statistics', 'Stats Graph', 'Port Thresholds', and 'Port Log'. The 'Eth Interface' section shows 'Ethernet Interface: NONE'. The 'General' sub-tab contains the following settings:

- Enabled DHCP instances or NONE: [Text Input Field]
- Filter on DHCP: [ON ▼]
- DHCP Ageing: [OFF ▼]
- MAC Addr Learn Limit (1-64) or Off: [Text Input Field]
- VLANS: [Text Input Field]
- Untagged Vlan: [Dropdown Menu]
- Tagged Vlan: [Dropdown Menu]

At the bottom of the form area are 'Modify' and 'Clear' buttons. Below the form area are 'Recent Commands...', 'Close', and 'Help' buttons. A status bar at the very bottom reads: 'Mon Sep 12 17:41:32 EDT 2005 - Polling of 172.16.33.18 successful.'

FIGURE 5-183 NTE DS1 Port Management Form - Eth Interface Tab (General)

For information on the parameters, refer to the iMAP User Guide.

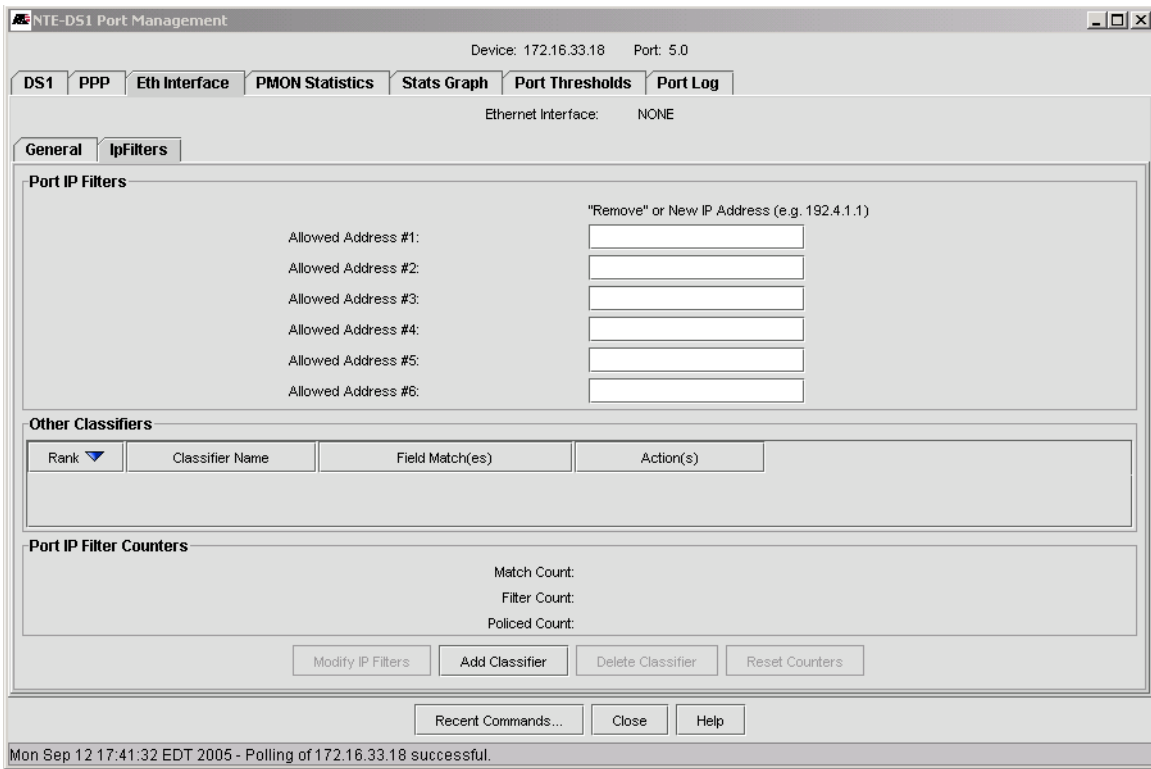

FIGURE 5-184 NTE DS1 Port Management Form - Eth Interface Tab (IpFilters)

TABLE 5-49 NTE DS1 Port Management - Eth Interface - IP Filters Tab

Field/Button	Description
Allowed Addresses	
Other Classifiers	
Port IP Filter Counters	For the Eth interface the traffic management counters: - Match - Number of packets that match any of the criteria - Filter - Number of packets dropped because they do not match any of the criteria - Policed - Number of non-conforming packets
Add Classifier	Add a Classifier to those that are associated with the interface. The Add Classifier to Port form appears. In this form the user can select a classifier that already exists or create a new classifier with an IP range and Precedence
Delete Classifier	Deletes a classifier chosen from the Classifier (Other Classifiers) list.
Reset Counters	Sets to 0 the Port IP Filter Counters

5.6.21.4 PMON Statistics Tab

This form allows the user to see the statistics associated with all aspects of the NTE8 port (signal, line, path, and PPP). On a current 15 minutes basis, it includes packet counts.

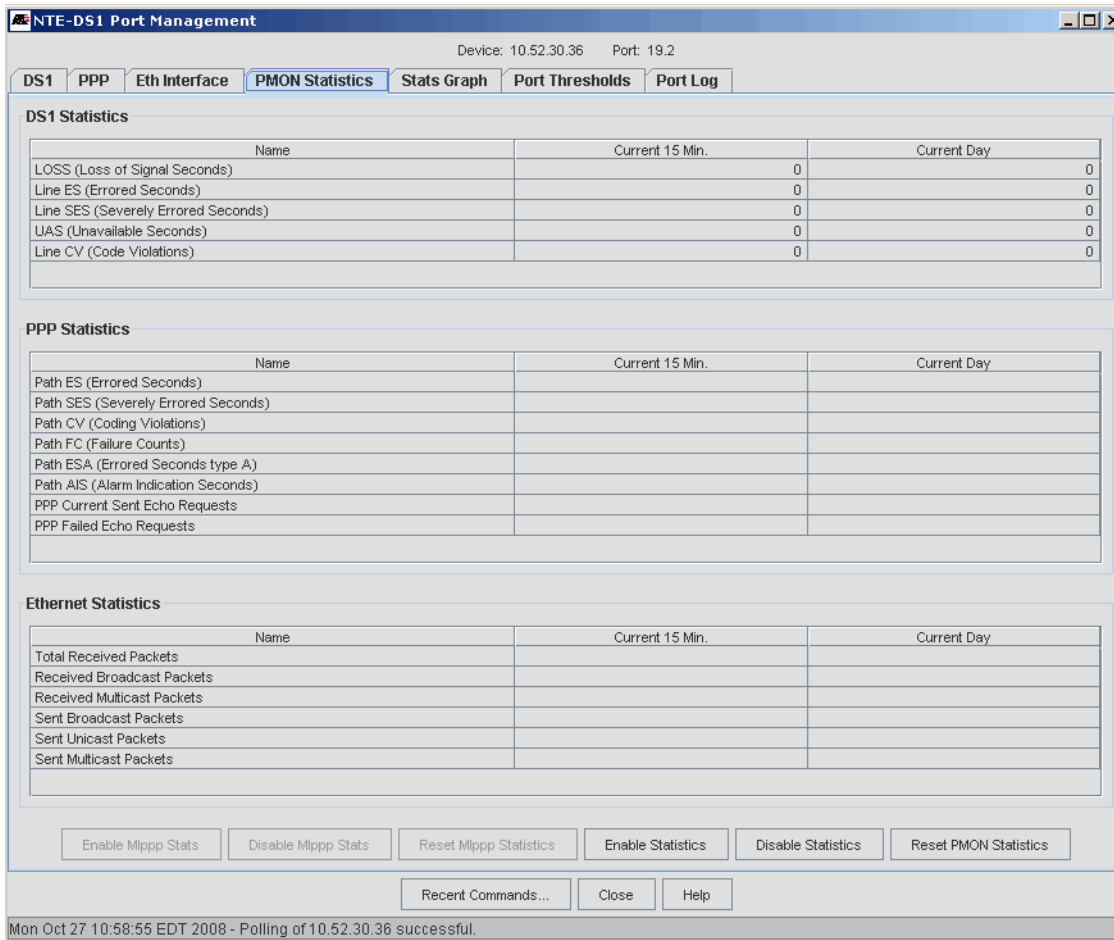

FIGURE 5-185 NTE DS1 Port Management Form - PMON Statistics Tab

- Enable Statistics - Activates all the statistics
- Disable Statistics - Deactivates all the statistics
- Reset Statistics - Sets all the statistics to 0

5.6.21.5 Stats Graph tab

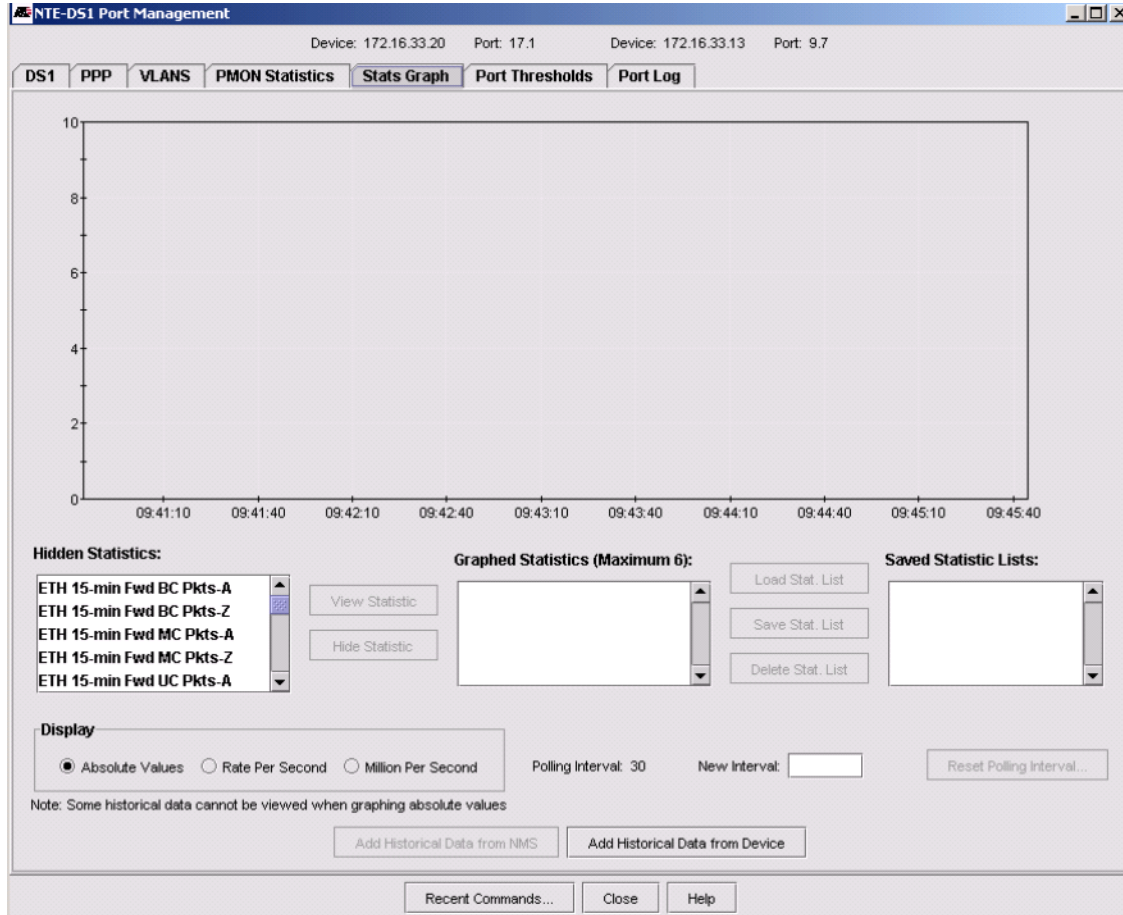

FIGURE 5-186 NTE DS1 Port Management Form - Stats Graph Tab

TABLE 5-50 NTE DS1 Port Management - Stats Graph Tab

Field/Button	Description
Hidden Statistics:	Statistics not added to the resulting graph
View Statistic:	Enabled when a statistic is chosen form Hidden Statistics, clicking this button adds it to the Graphed Statistics (Maximum of 6), which is the current list of statistics being graphed.
Hide Statistic:	Enabled when a statistic is chosen form Graphed Statistics, clicking this button deletes it from the Graphed Statistics/
Load Stat. List	After choosing one of the names from the Saved Statistic list, the user clicks on this button to make it the current Graphed Statistics
Save Stat. List	The user is prompted to save the current list with a name. Once saved, it is added to the Saved Statistics Lists.
Delete Stat. List	After choosing one of the names from the Saved Statistic list, the user clicks on this button to delete this name.

TABLE 5-50 NTE DS1 Port Management - Stats Graph Tab

Field/Button	Description
Display	The attribute that controls the display: - Absolute Values - Rate Per Second - Million Per Second
Polling Interval:	The Current Polling Interval in seconds
New Interval:	Sets a new interval for polling. This is set with the Reset Polling Interval button.
Add Historical Data from NMS:	Adds the data collected previously from NMS Performance Management
Add Historical Data from Device:	Adds the data collected previously from the device.

5.6.21.6 Port Thresholds Tab

This form allows the user to modify the threshold values for the DS1/E1 and PPP statistics. When a new value is entered in the New Value field, the Modify button is enabled.

Note: In most cases, these DS1/E1 values are not modified because they are part of the DS1/E1 port profile; if the user does change a value, the port is now out of sync with its associated profile, and "" will appear next to the Profile name on the DS1/E1 Port tab form (as well as the Port Inventory table). In the dual endpoint configuration, the "*" will appear next to the specific port where the values were changed from the Profile. To Resync the port, the user must re-apply the profile on the DS1/E1 tab form, which puts the values back to what they are in the Profile.*

The screenshot shows a web-based interface for NTE-DS1 Port Management. At the top, there are tabs for DS1, PPP, VLANS, PMON Statistics, Stats Graph, Port Thresholds, and Port Log. The 'Port Thresholds' tab is active. The interface is divided into two main sections: 'NTE-DS1 Thresholds' and 'PPP Thresholds'. Each section contains a table with columns for 'Current Value' and 'New Value' for two different device configurations: 172.16.33.20 Slot:Port: 17.1 and 172.16.33.13 Slot:Port: 9.7. The 'NTE-DS1 Thresholds' section lists ten metrics, all with a current value of 0. The 'PPP Thresholds' section lists two metrics, also with a current value of 0. At the bottom of the form, there are buttons for 'Modify', 'Clear Entry Fields', 'Recent Commands...', 'Close', and 'Help'.

	172.16.33.20 Slot:Port: 17.1		172.16.33.13 Slot:Port: 9.7	
	Current Value	New Value	Current Value	New Value
Line Errored Seconds - ES-L (0..900):	0	<input type="text"/>	0	<input type="text"/>
Line Severely Errored Seconds - SES-L (0..900):	0	<input type="text"/>	0	<input type="text"/>
Unavailable Seconds - UAS (0..900):	0	<input type="text"/>	0	<input type="text"/>
Line Coding Violations - CV-L (0..32767):	0	<input type="text"/>	0	<input type="text"/>
Path Errored Seconds - ES-P (0..900):	0	<input type="text"/>	0	<input type="text"/>
Path Severely Errored Seconds - SES-P (0..900):	0	<input type="text"/>	0	<input type="text"/>
Path Coding Violations - CV-P (0..32767):	0	<input type="text"/>	0	<input type="text"/>
Path Failure Counts - FC-P (0..32767):	0	<input type="text"/>	0	<input type="text"/>
Path Errored Seconds, Type A - ESA-P (0..900):	0	<input type="text"/>	0	<input type="text"/>
Path AIS Seconds - AISS-P (0..900):	0	<input type="text"/>	0	<input type="text"/>

	Current Value	New Value	Current Value	New Value
Sent Echo Requests (0..32767):	0	<input type="text"/>	0	<input type="text"/>
Failed Echo Requests (0..32767):	0	<input type="text"/>	0	<input type="text"/>

FIGURE 5-187 NTE DS1 Port Management Form - Stats Graph Tab

5.6.21.7 DS1 Port Management - Port Log Tab

This form lists the PORT logs associated with the port(s) and can therefore provide a history of provisioning as well as any errors or problems. Refer to the following figure.

DS1	PPP	VLANS	PMON Statistics	Stats Graph	Port Thresholds	Port Log	
Device	Port	Severity	Category	Time	Sequence	Type	Message
172.16.33.20	17.1		PORT007	2066-07-07 16:49:50	0144	INFO	Location: Slot 17 Port: 1 Description: Port state change From: UP-DOWN-Dependency To: DOV
172.16.33.20	17.1		PORT008	2066-07-07 16:49:51	0150	INFO	Location: Slot 17 Port: 1 Description: Provisioning applied to the
172.16.33.20	17.1		PORT008	2066-07-07 16:49:51	0146	INFO	Location: Slot 17 Port: 1 Description: Provisioning applied to the
172.16.33.20	17.1		PORT008	2066-07-07 16:49:51	0148	INFO	Location: Slot 17 Port: 1 Description: Provisioning applied to the
172.16.33.20	17.1		PORT007	2066-07-07 16:49:52	0157	INFO	Location: Slot 17 Port: 1 Description: Port state change From: DOWN-DOWN-Dependency To: !
172.16.33.13	9.7		PORT008	2026-07-12 14:48:55	9278	INFO	Location: Slot 9 Port: 7 Description: Provisioning applied to the
172.16.33.13	9.7		PORT008	2026-07-12 14:48:55	9276	INFO	Location: Slot 9 Port: 7 Description: Provisioning applied to the
172.16.33.13	9.7		PORT007	2026-07-12 14:48:56	9285	INFO	Location: Slot 9 Port: 7 Description: Port state change From: DOWN-DOWN-Dependency To: !
172.16.33.13	9.7		PORT007	2026-07-12 14:48:55	9272	INFO	Location: Slot 9 Port: 7 Description: Port state change From: UP-DOWN-Dependency To: DOV
172.16.33.13	9.7		PORT008	2026-07-12 14:48:55	9274	INFO	Location: Slot 9 Port: 7 Description: Provisioning applied to the

FIGURE 5-188 NTE DS1 Port Management - Port Log Tab

5.6.22 SHDSL Bonding (Card Level to Port Level)

In prior releases the SHDLS WireMode was set in the Card Management application, as shown in 5.5.8. This support will remain for iMAP systems running earlier software version. However, when both of these conditions are true:

- iMAP systems are running release 7.1 or later, which support port-based bonding
- The AlliedView NMS at release 8.0.

the Port Management application will show the GUI to support bonding.

Impacts on other features are as follows:

- WireMode is **not** added to the SHDSL Port Profile, because it affects the adjacent port, which might already be assigned.
- Both the Port Details window and Triple Play Port Provisioning form will support setting the “WireMode” of **even-numbered** SHDSL ports.

The following figures show these changes.

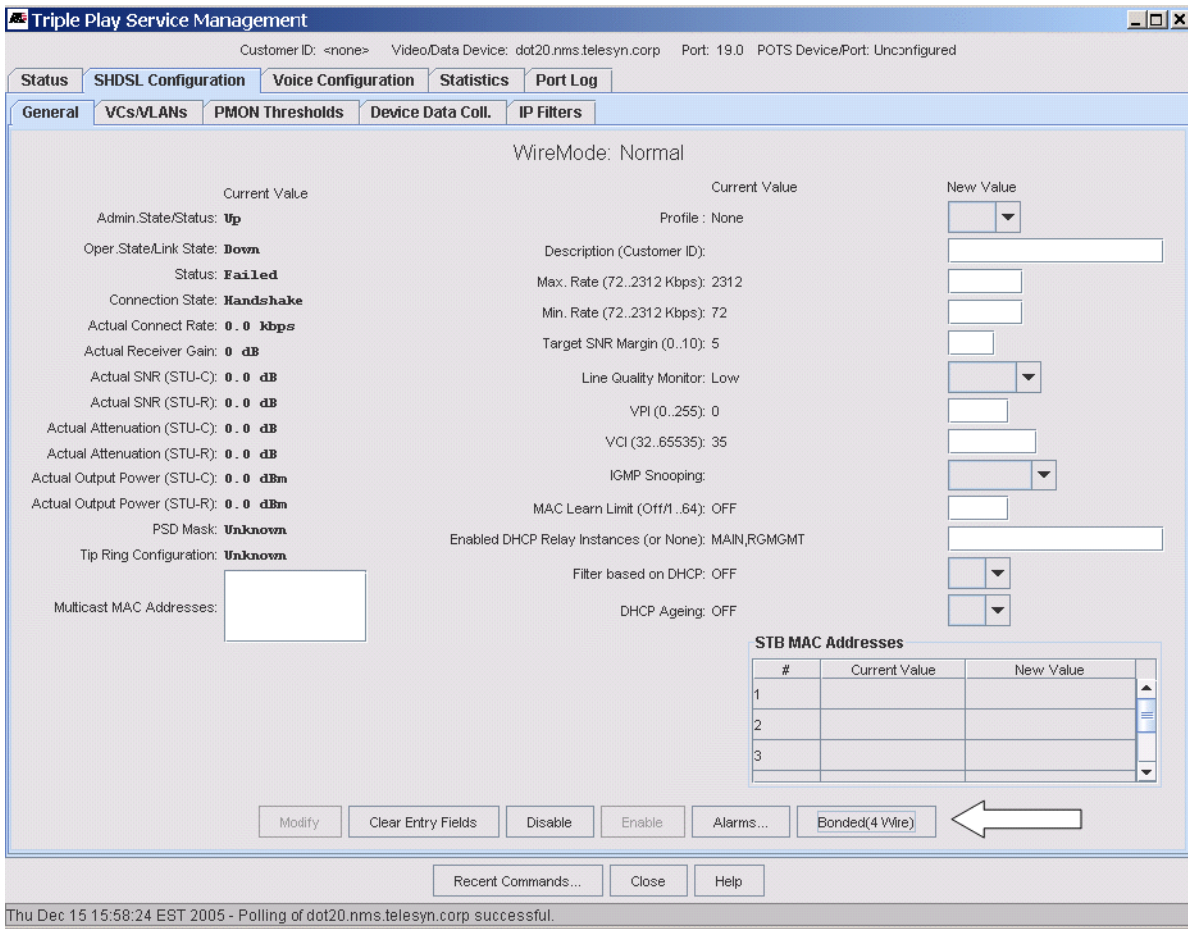

FIGURE 5-189 SHDSL Configuration - General Tab with Bonded Option

Provision New Triple Play Customer

Description (Customer ID):

IMG/RG General Configuration

IMG/RG General Profile: IMG/RG MAC Address:

Video/Data Configuration

Access Device: Slot Port: (SHDSL) Bond To: Port Profile:

VLAN Settings: Untagged VLAN: Tagged VLAN(s):

Allowed IP Addr. Ranges: IP Addr/# Bits (e.g. 192.4.1.0/24)

Range #1: Range #2: Range #3:

Range #4: Range #5: Range #6:

Video Service Config:

Allowed STB MAC Addr:

STB #1: STB #2: STB #3:

STB #4: STB #5: STB #6:

Voice Configuration

POTS: Access Device: Slot Port: POTS Port Profile:

POTS Call Agent: Line Profile: Interface Group: CRV:

Derived Voice:

GenBand Configuration: Gateway: Call Agent:

Schedule

Now Hold Schedule:

FIGURE 5-190 Triple Play Form for SHDSL with Bonding Option

Using the Triple Play form, individual even numbered ports can be bonded to the next higher odd port. Therefore, when the user selects an even numbered port, the “Bond To:” selector is enabled. Either the next port, or a blank entry, can be selected. Provisioning will set the wire mode appropriately.

Note: Provisioning will first deprovision a port, which will automatically unbond it, then if necessary it will be rebonded.

As ports are bonded (or unbonded), the following occurs:

- When changing a port on the TriplePlay form, the odd port is removed from the list of ports that can be selected.
- Configuration changes are reflected in the Customer Ports table in Network Inventory.

5.6.23 View the EPON2 Port Configuration

The EPON2 port corresponds to the OLT on the EPON2 card that connects to up to 32 ONUs. The attributes are shown on the EPON Port Management Form.

EPON Port Management

Device: 10.52.30.35 Port: 9.0

General | Port Statistics | Stats Graph | Port Log

Current Value	Current Value	New Value
Admin. State/Status: Up	Profile: None	<input type="text"/>
Oper. State/Link State: Up	Description (Customer ID): 35EPON90	<input type="text"/>
Availability Status: Online	IPMC VLAN Id (1..4094): 40	<input type="text"/>
Control Status: Unknown	IP Address: 10.52.31.140	<input type="text"/>
Procedural Status: Unknown	IPMC Policy: NONE	<input type="text"/>
Port Type: EPON	BRUUM Policy: NONE	<input type="text"/>
Interface Profile Name: newEPON	Minimum Loop Length (0..60 km): 0	<input type="text"/>

Note
A ? at the end of a policy name indicates a policy that already exists on the device, but is not a NMS QoS Policy. You are encouraged to use NMS QoS Policies. See the online help for more information.

Modify Clear Entry Fields Disable Enable Alarms... Recent Commands... Close Help

Tue Jan 17 14:08:12 EST 2012 - Polling of 10.52.30.35 successful.

FIGURE 5-191 EPON Port Management - Tabbed Form

TABLE 5-51 EPON Port Management - General Tab

Field/Button	Description
Admin. State/Status	Whether the EPON2 can go into service and therefore pass traffic
Oper. State/Link State	When the Admin State is up, whether the link is passing traffic
Availability Status	Dependency, meaning the state of the upstream component determines this component's status.
Control Status	
Procedural Status	
Port Type	Always EPON
Profile	The user can create a profile for the EPON2 port and apply it to this port.
Description (Customer ID)	Unique way to identify the port
IPMC VLAN Id (1..4094)	The VLAN that carries downstream multicast traffic
IP Address	Set this to an address that is appropriate for the IPMC subnet. The default 0.0.0.0 may not work as some STBs (such as Amino) require the IPMC IP Address to be set on the EPON interface.
IPMC Policy	The SLA Policy that control the downstream attributes for the IP Multicast VID. (Any upstream attributes are ignored.) This SLA therefore applies to all the ONUs on the EPON2 interface.

TABLE 5-51 EPON Port Management - General Tab

Field/Button	Description
BRUUM Policy	This policy is for the same VID as the downstream-only video stream, but it applies to all upstream traffic from that ONU, and known/learned unicast downstream traffic to that ONU. The ONU/VLAN association and corresponding SLA must be provisioned if unicast or broadcast traffic is required for operation (e.g. DHCP is used for IP address assignment).
Minimum Loop Length (0..60 km)	Allow for setting the allowed distances. The value entered is added to the minimum value of 20, so the maximum is 80 (60 +20). Note that the OLT must be disabled to change this value.

5.6.24 ONU Configuration (as ON1000 or as part of iMG646PX-ON)

Once the ONU (customer port) is provisioned, the administrator can view the Triple Play Service Management Form and see all of the attributes for the ONU. Note that the Form in this case includes the ONU Configuration tab, as shown in the following figure.

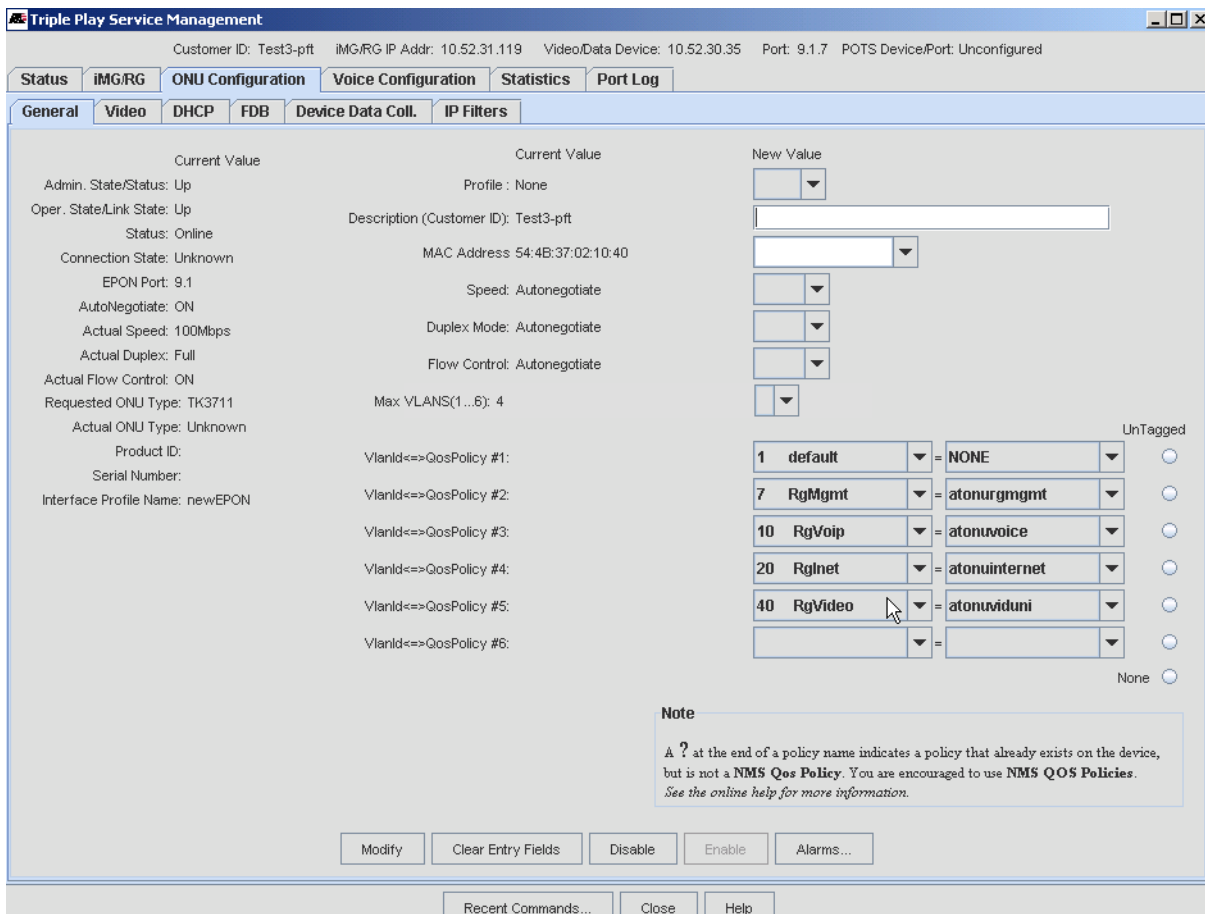

FIGURE 5-192 Service Management Form for ONU

Because this reflects the ONU configuration, there are attributes that are unique on the lower part of the Form. For the ONU, the user creates on the iMAP QoS policies that are the association of a VLAN and the ONU. These usually reflect the kind of traffic the VLAN will carry. The Form can list the up to six VLANs that can be provisioned (although in most cases five are configured for Triple Play, with three for the services, one for the RGMgmt VLAN, and one for a class of traffic called BRUUM, explained in the iMAP User Guide).

The user can see the VLAN id and QoS Policy as highlighted in the figure. The default QoS policy is named “NONE” and can be associated with one or more VLANs. The user has the option of selecting **one** of the VLANs as the **untagged** VLAN, and so the selection uses a radio button.

Note: Refer to 6.11.11 for details on policies for the EPON/ONU.

Note: Refer to Section 7 for complete information on provisioning the iMG/RG.

As with other port type configuration tabs, the Video Tab is added in release 9.0 and includes the IGMP / multicast information.

5.6.25 VDSL24 Port

In the VDSL configuration, a VDSL modem is connected to the VDSL24 card, and because of the higher bandwidth services such as HDTV can be supported.

Note: In release 9.0, an iMG/RG that supports VDSL is not yet available, but an Allied Telesis VDSL modem can be used. Refer to the iMAP Component Specification for details.

Note that the interface can support ADSL (ADSL2+) as well as VDSL2 mode. To switch modes, the user must disable the interface, and then switch modes on this form.

5.6.25.1 VDSL Configuration - General Tab

This screen includes all the attributes that define the port, as show in the following figure.

As with the VDSL Port Profile, general parameters on the VDSL View/Modify screen are redistributed from one to two tabs. Power management parameters are added to the updated General tab and the other rate-related parameters are moved to the Rate Settings tab. As with ADSL, the read-only parameters are added to the left and the modifiable parameters are added to the right.

Although power management parameters will be left off the screen when the iMAP release is less than 11.0.0, the remaining general parameters will still be distributed between the General and Rate Settings tabs

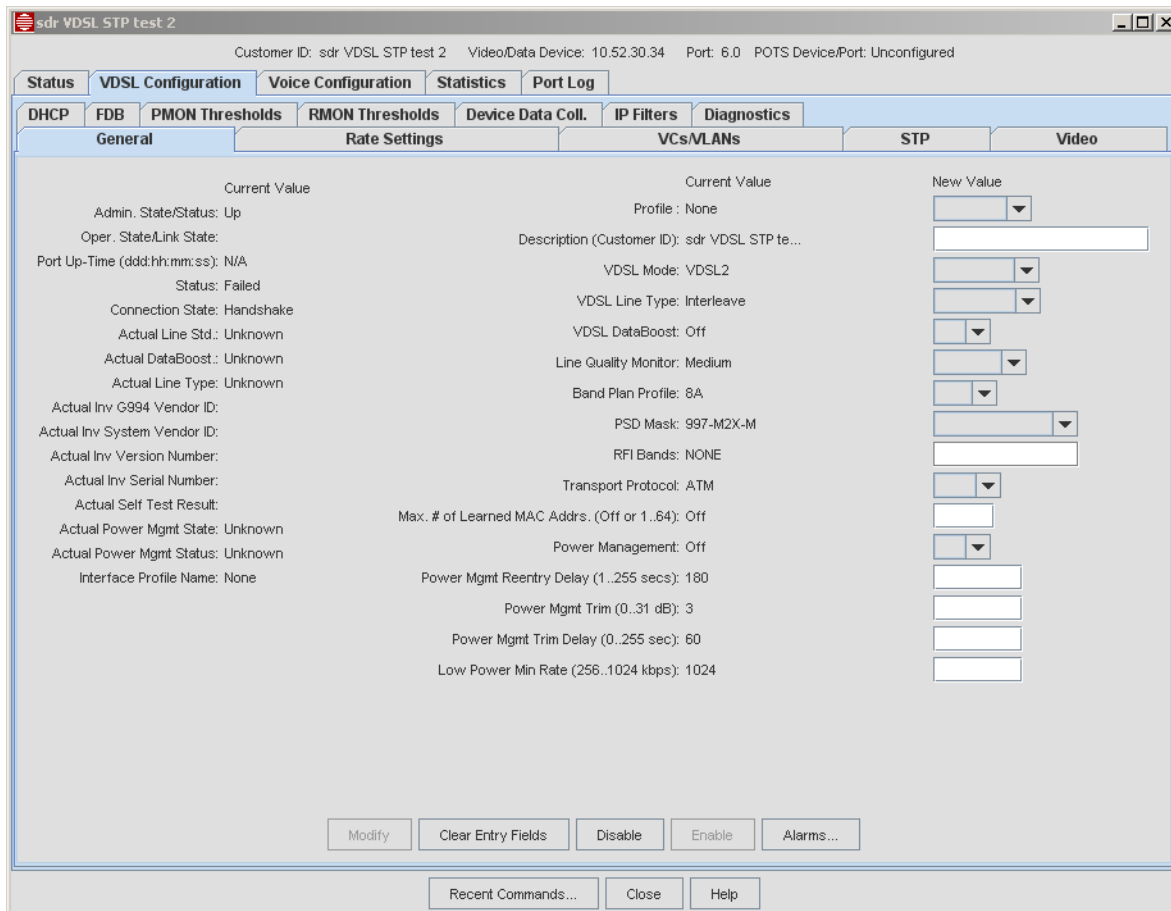

FIGURE 5-193 VDSL Configuration - General Tab

TABLE 5-52 VDSL Configuration Form, General Tab

Field/Button	Description
Admin. State/Status	The Administrative State can be controlled and determines the Operational State. Refer to 5.5.24 .
Oper. State/Link State	The ability of the port to provide service. The Administrative State must be up and then the system determines if the port can provide service.
Port Up-Time	Amount of time the physical interface has been in the UP-UP-Online state.

TABLE 5-52 VDSL Configuration Form, General Tab (Continued)

Field/Button	Description
Status	The status of the port that follows from the Administrative State and Operational State. For meanings, refer to the iMAP User Guide, Section 4. <ul style="list-style-type: none"> - ONLINE - IN TEST - FAILED - OFFLINE - DEPENDENCY - DEGRADED - NOT INSTALLED - INITIALIZATION REQUIRED - TERMINATING
Connection State	The connection state, such as Idle or Showtime
Actual Line Std.	The line standard that was actually chosen.
Actual Databoost	Whether the DATABOOST feature has been implemented
Actual Line Type	The line type that was actually chosen.
Actual Inv G994 Vendor ID	To Be Supplied
Actual Inv System Vendor ID	To Be Supplied
Actual Inv Version Number	To Be Supplied
Actual Inv Serial Number	To Be Supplied
Actual Self Test Result	To Be Supplied
Actual Power Mgmt State	The state the interface is in for power reduction (Full On, Low Power, Idle)
Actual Power Mgmt Status	Whether the power management feature has been activated for the interface
Interface Profile Name	Which profile is being used (AutoProv or none, which uses default values).
Profile	Enter another VDSL Profile Name
Description (Customer ID)	An ID that can be given to uniquely identify the port. In most cases, the subscriber's telephone number is used. Refer to 7.2.7.
VDSL Mode	Specifies the mode for the VDSL port. For the VDSL24A and VDSL24B cards, VDSL2 is the default. The parameters that are provisionable depend on whether the VDSL2 or ADSL mode is chosen
VDSL Line Type	Defines the type of VDSL physical line entity that exists, by defining whether and how the line is channelized.
VDSL Databoost	Whether the Databoost feature has been provisioned
Line Quality Monitor	The level the line quality monitor has been set at. Refer to the iMAP User Guide.
Band Plan Profile	Band plan profile for frequency settings. The band plan determines the transmission frequencies used when transmitting and receiving data between the interface and the modem
PSD Limit Mask	VDSL/ADSL power spectrum density limits are defined by the band plan. The various standard bodies have defined a number of band plans that have regional significance. The masks define shaping parameters for the signal, including Annex A or Annex B

TABLE 5-52 VDSL Configuration Form, General Tab (Continued)

Field/Button	Description
RFI Bands	Specifies the radio frequency interference bands to filter from the VDSL link. To avoid interference it is necessary to introduce power control (notching) in one or more of these bands.
Transport Protocol	Used to specify the type of transport used when operating in VDSL mode. When running in ATM mode, the VDSL interface can automatically toggle to ADSL if the modem at the other end of the connection is ADSL. PTM (Packet Transport Mode) requires both ends of the connection to be VDSL compliant If the Transport Protocol is changed from ATM to PTM, there is a warning that VCs are not supported, and any existing VCs will be removed from the port.
Max. # of Learned MAC Adrs.	Depending on feature provisioning, the number of MAC addresses that can be learned (or Off)
Power Management	Changes the current power management state.
Power Mgmt Reentry Delay	The amount of time that must elapse before re-entering the Low Power state after a transition to the Full On state. (Should not be set to a value less than 120 seconds)
Power Mgmt Trim	The maximum aggregate transmit power reduction (trimming) that can be performed with each power trim operation in the Low Power state.
Power Mgmt Trim Delay	The amount of time that must elapse before an additional reduction (trimming) of power occurs in the Low Power state.
Low Power Min Rate	The minimum net data rate for the bearer channel while operating in the Low Power state. The value for LOWPOWERRATE must be between MAXDOWNSTREAMRATE and MINDOWNSTREAMRATE
Modify	Enabled when a value in New Value field has been entered, modifies the attributes according to the updated values. There is an error message if a value is invalid.
Clear Entry Fields	Clear any fields that have been datafilled but not yet Modified
Enable	Enabled if the port is in an Administrative State of DOWN, enables the port and so brings the Administrative State to UP. If possible (for example, the VDSL2 card must be enabled), the Operational State will change to UP.
Disable	Enabled if the port is in an Administrative State of UP, disables the port and so brings the Administrative State to DOWN. The Operational State will also change to DOWN.
Alarms	Invokes the Alarm table of the Fault Management Object.

TABLE 5-53 VDSL Configuration Form, Rate Settings Tab

Field/Button	Description
Actual Connect Rate	The upstream/downstream rate that was actually attained.
Max. Attainable Rate	The possible upstream/downstream rate according to dsl type and mode.
Actual SNR (Near End/Far End)	The signal-noise ratio for near end/far end that was actually attained.
Actual Attenuation (Near End/Far End)	The attenuation for near end/far end that was actually attained.
Actual Output Power (Near End/Far End)	The output power achieved for near end/far end.
Actual Upstream/Downstream PSD	The actual transmit upstream PSD setting.

TABLE 5-53 VDSL Configuration Form, Rate Settings Tab (Continued)

Field/Button	Description
Actual Upstream/Downstream INP	The actual impulse noise protection value for upstream
Max. Upstream Rate	Specifies the maximum upstream bit rate to attain for a VDSL port. The valid range for this parameter is from 32Kb to 14848. Leaving this rate to the default of 10000 (10Mbps) ensures the higher downstream rates (50 Mbps) for VDSL
Min. Upstream Rate	Specifies the minimum upstream bit rate to attain for a VDSL port. The MINUPSTREAMRATE must be equal or less than the MAXUPSTREAMRATE
Max. Downstream Rate	Specifies the maximum downstream bit rate to attain for a VDSL port. The valid range for this parameter for VDSL is from 32Kb to 51200Kb
Min. Downstream Rate	Specifies the minimum downstream bit rate to attain for a VDSL port. The valid range for VDSL is from 32Kb to 51200Kb. The MINDOWNSTREAMRATE must be less than the MAXDOWNSTREAMRATE.
Max. Downstream Interleave Delay	Specifies the maximum interleave delay in milliseconds used when the VDSL linetype is set to INTERLEAVE.
Max. Upstream Interleave Delay	Specifies the maximum interleave delay in milliseconds used when the VDSL linetype is set to INTERLEAVE.
Target SNR Ratio Margin	Specifies the target signal-to-noise ratio (in dB) to achieve on a VDSL port. The valid range is 0 to 30 for a VDSL interface, with the default 0 for a VDSL interface. This allows the operator to adjust the signal characteristics to account for such things as known noise in the binder group, extreme length of a loop, or other issues in the copper plant
Max. SNR Margin	Used to set the maximum signal-to-noise ratio supported by the interface. The value for this parameter must be greater than the value for Target SNR Margin. Optionally, this parameter can be set to 'OFF' which eliminates any maximum limit for SNR.
Min. SNR Margin	Sets the minimum signal-to-noise ratio supported by the interface. The value for this parameter must be less than the value for Target SNR Margin. Optionally, this parameter can be set to OFF which eliminates any minimum limit for SNR.
Max. Upstream Nominal PSD	VDSL/ADSL power spectrum density limits are defined by the band plan and determine this value.
Max. Downstream Nominal PSD	VDSL/ADSL power spectrum density limits are defined by the band plan and determine this value.
Max. Receive Power	Specifies the maximum received power level in dBm received from the modem before the interface is alarmed and disabled.
Minimum Upstream INP	Sets the minimum impulse noise protection value for upstream.
Minimum Downstream INP	Sets the minimum impulse noise protection value for downstream.
Modify	Enabled when a value in New Value field has been entered, modifies the attributes according to the updated values. There is an error message if a value is invalid.
Clear Entry Fields	Clear any fields that have been datafilled but not yet Modified
Enable	Enabled if the port is in an Administrative State of DOWN, enables the port and so brings the Administrative State to UP. If possible (for example, the VDSL2 card must be enabled), the Operational State will change to UP.
Disable	Enabled if the port is in an Administrative State of UP, disables the port and so brings the Administrative State to DOWN. The Operational State will also change to DOWN.
Alarms	Invokes the Alarm table of the Fault Management Object.

5.6.25.2 VDSL Configuration - VCs/VLANs Tab

This screen is determined by the mode of the port. If the port is in VDSL mode and using ATM, there is only a VPI/VCI of 0/35 that cannot be changed. If the port is in VDSL mode and using PTM, there is no VCI, only a data channel. In ADSL mode, the VPI/VCI follow the ADSL configuration (up to four VPI/VCI).

VDSL Configuration - Other Tabs

The remaining tabs follow the same concepts as the ADSL configuration. Refer to 5.6.17.

5.6.26 Statistics Tab

The statistics tab for an overall port are shown by clicking on the Statistics tab for the port. Refer to the following figures and tables.

5.6.26.1 PMON Stats Tab

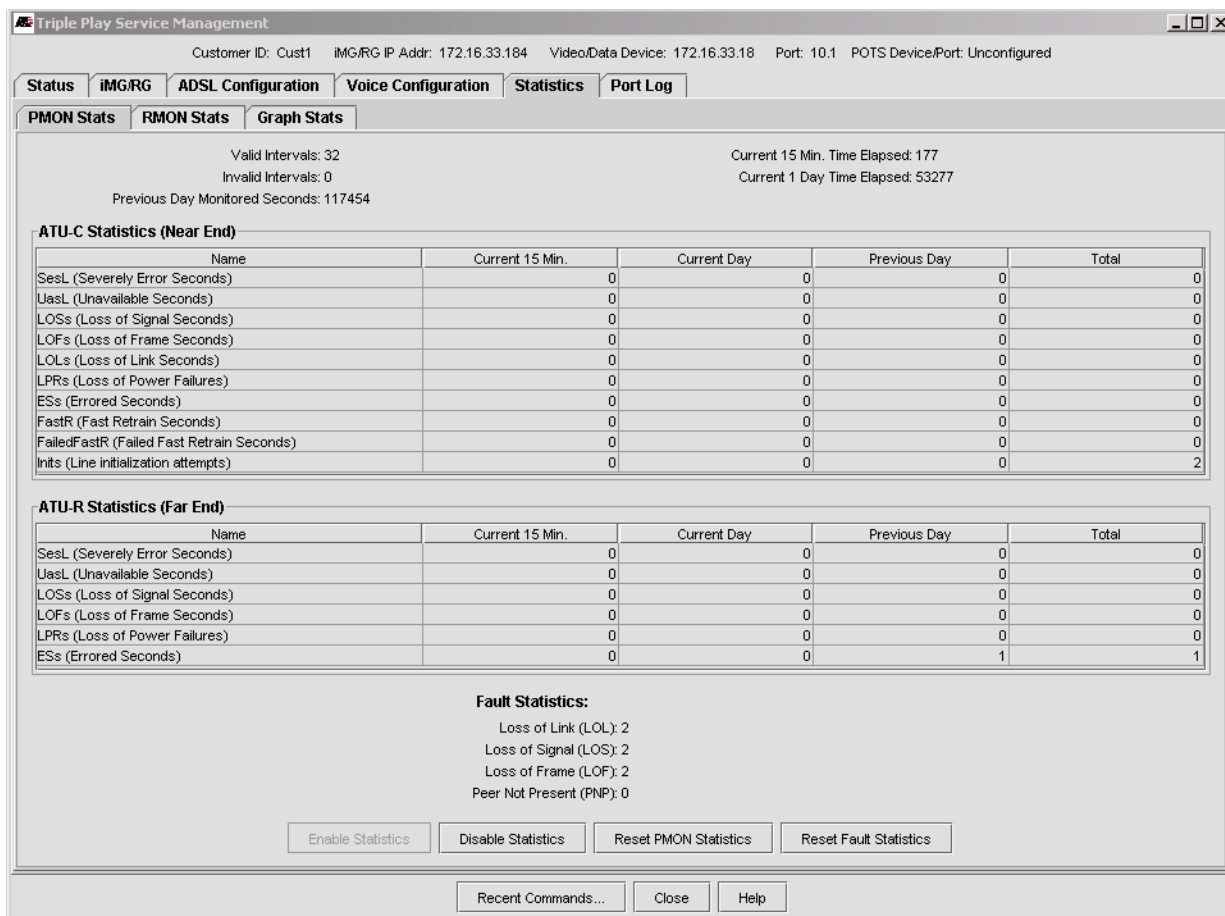

FIGURE 5-194 Statistics - PMON

The ATU-C and ATU-R statistics have the following measurements:

- Valid Intervals
- Invalid Intervals
- Previous Day Monitored Seconds
- Current 15 min. Time Elapsed
- Current 1 Day Time Elapsed

The table for each statistic type gives the count for the periods.

The Fault Statistics are counters, which are part of the ATN Enterprise MIB, that help to monitor the ADSL port by incrementing continuously until reset. By doing this, the history of certain events can be shown over time in order to obtain a more accurate view of what is happening with the ADSL port.

No management logs are produced with these counters, since they are cumulative, and so logs are produced for each individual event.

These counters can be reset to 0 by selecting **Reset Fault Statistics**.

Refer to the iMAP User Guide for details about these counters.

5.6.26.2 RMON Stats Tab

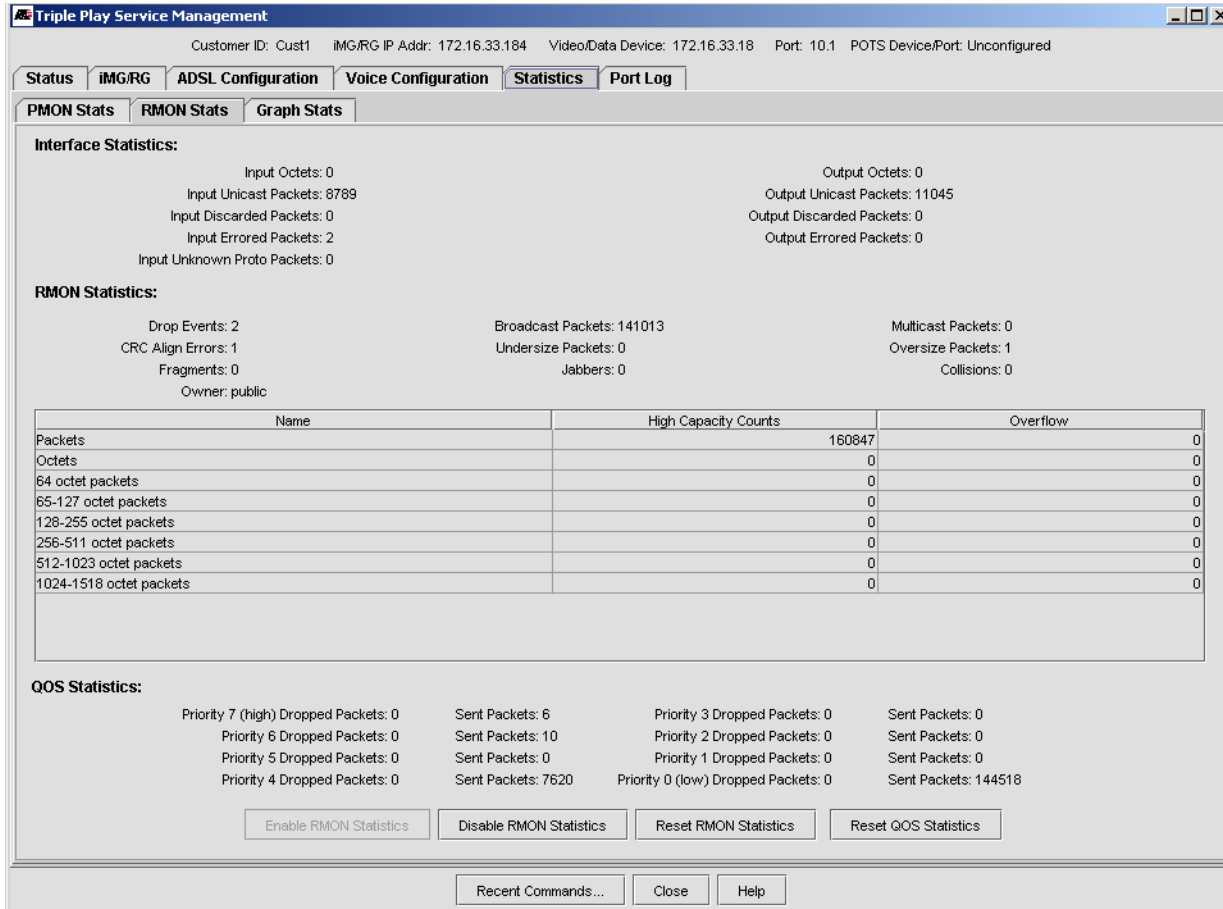

FIGURE 5-195 Statistics - PMON

RMON Statistics deal with packet flows and highlight errors as well as overflows of packets.

The QOS Statistics are counters for each priority queue that allow the user to see the ratio of sent versus dropped packets. These are cumulative and so produce no management logs.

These counters can be reset to 0 by selecting **Reset QOS Statistics**.

Refer to the iMAP User Guide for details about these counters.

5.6.26.3 Graph Stats Tab

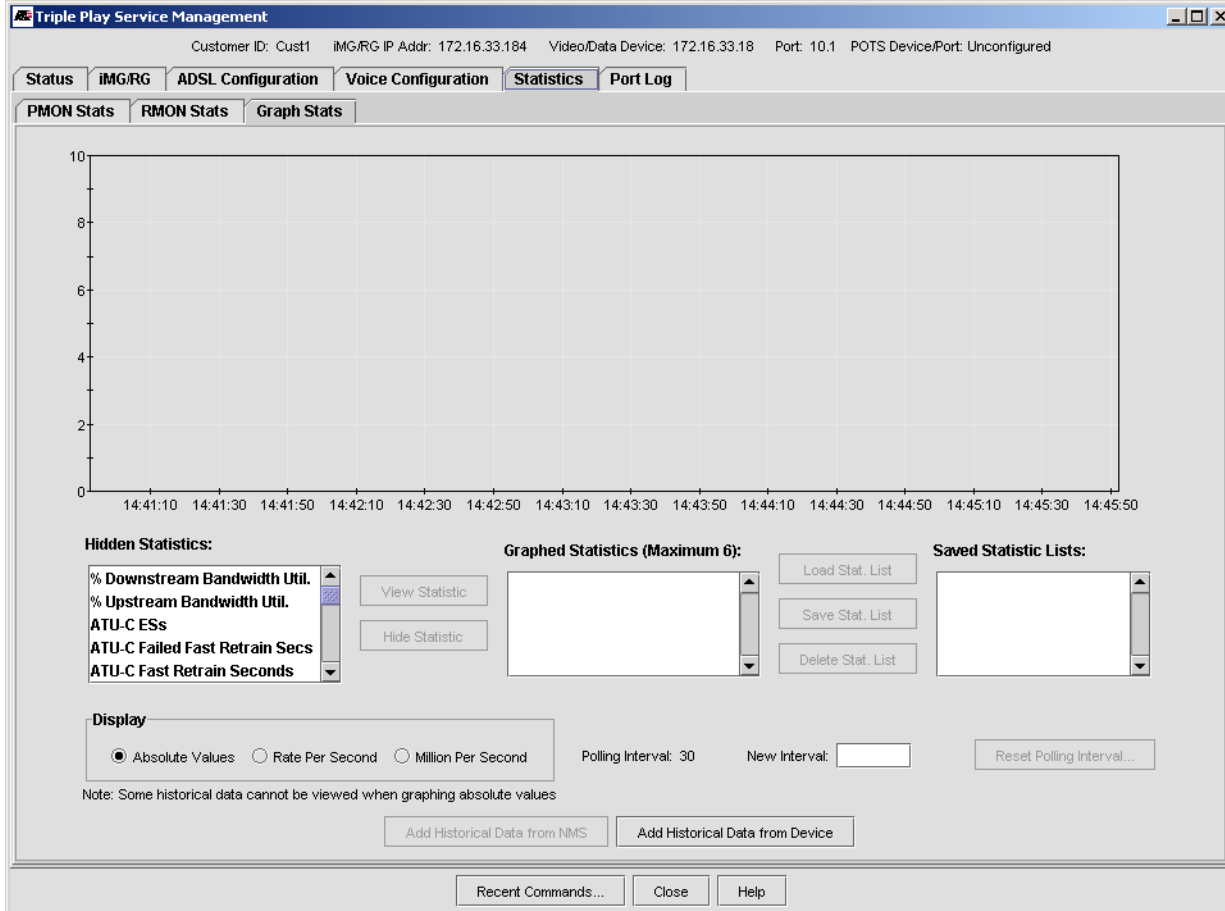

FIGURE 5-196 Statistics - Graph Stats

TABLE 5-54 Stats Graph Tab

Field/Button	Description
Hidden Statistics:	Statistics not added to the resulting graph
View Statistic:	Enabled when a statistic is chosen form Hidden Statistics, clicking this button adds it to the graph/
Hide Statistic:	Enabled when a statistic is chosen form Graphed Statistics, clicking this button deletes it from the graph/
Display	The attribute that controls the display: - Absolute Values - Rate Per Second - Million Per Second
Polling Interval:	Current Polling Interval in seconds
New Interval:	Sets a new interval for polling. This is set with the Reset Polling Interval button.

TABLE 5-54 Stats Graph Tab

Field/Button	Description
Add Historical Data from NMS:	Adds the data collected previously from NMS port management
Add Historical Data from Device:	Adds the data collected previously (buckets) from the device

5.6.27 Port Log Tab

Selecting the **Port Log** tab invokes a table that lists all the port-related management logs that have been generated. Refer to previous sections on the port log tab. (5.6.17.15, 5.6.19.7)

For a description of management logs and the meaning of fields, refer to the iMAP Log / Troubleshooting Manual.

5.6.28 DHCP Tab

For each port configuration tab, there is a DHCP sub-tab that supplies:

- DHCP statistics
- ability to associate a DHCP Relay instance to the port
- ability to set to ON or OFF DHCP Filtering and Ageing
- a table that shows the MAC address, VID and IP address association.

The user can also clear the statistics (Reset Counters)

Note: The user should select/changed the DHCP Relay instance with care. Refer to the iMAP User Guide for details on DHCP Relay, especially the difference between DHCP Relay and DHCO Snooping.

5.6.29 FDB Tab

For each port configuration tab, there is an Forwarding Database (FDB) sub-tab that shows the current VLAN ID (VID) and MAC Address associations, as well as the status.

5.6.30 Video Tab

The Video tab highlights the IGMP / multicast attributes. Refer to the following figure.

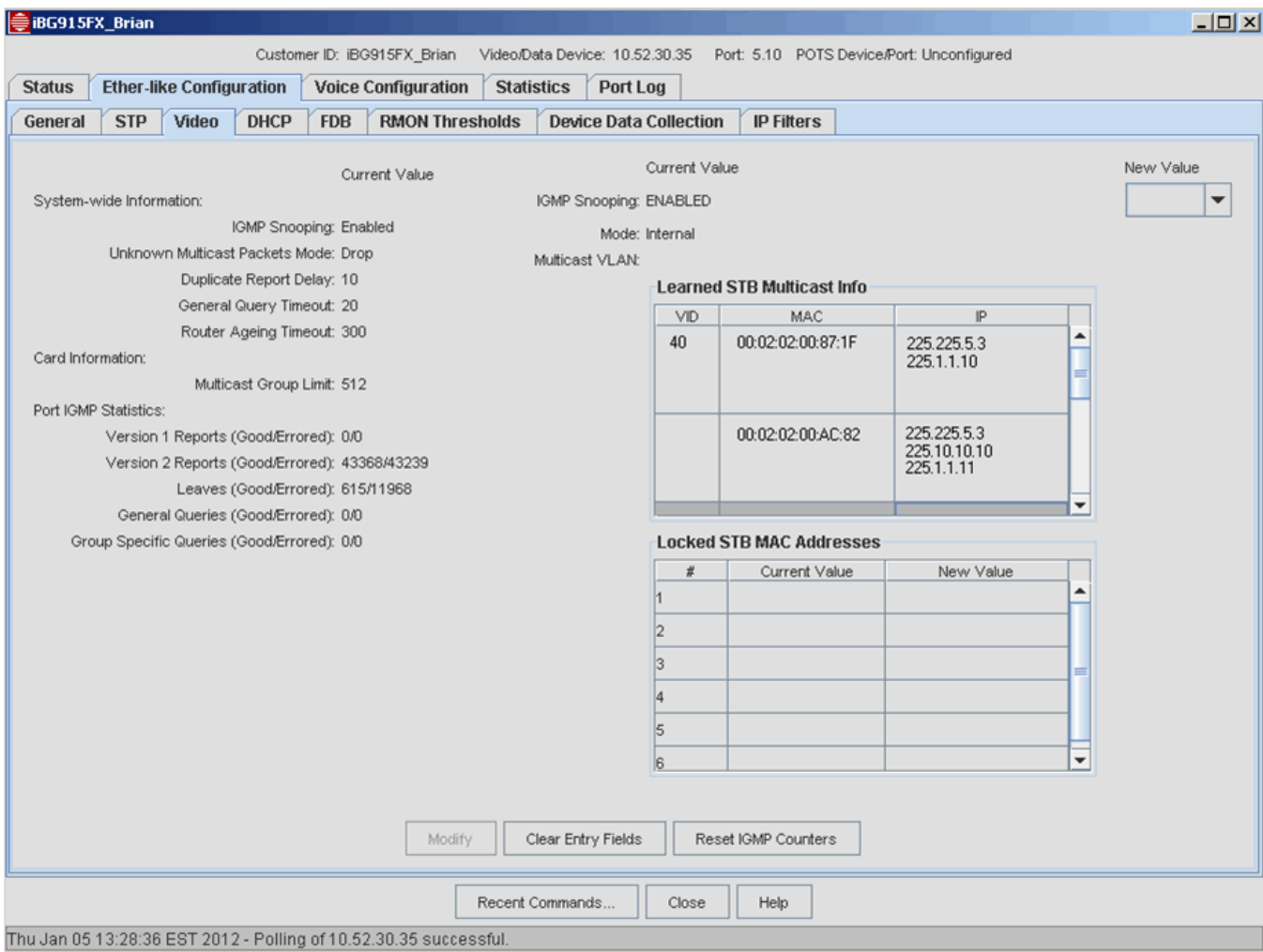

FIGURE 5-197 Video Tab

TABLE 5-55 Video Tab

Field/Button	Description
System-wide Information	These are the IGMP attributes that have been set for the device.
Card information	The attributes for the ADSL/VDSL card, such as the multicast Group Limit
Port IGMP Statistics	The good vs. errored number of IGMP Reports/Leaves/Queries for the port
IGMP Snooping	Whether IGMP is enabled on the port
Mode	The type of IGMP snooping to perform (Internal, External, MCPassthrough)
Multicast VLANs	VLANs that are currently carrying multicast traffic - This is included in the Learned STB Multicast Info table.
Multicast IP Addresses	The IP addresses being used for the multicast traffic

TABLE 5-55 Video Tab (Continued)

Field/Button	Description
Learned STB Multicast Info	<p>VID - The multicast VLAN</p> <p>MAC - The STB MAC Addresses that were learned and are in the FDB</p> <p>IP - The IP addresses being used for the multicast traffic</p> <p>Note: These three attributes are placed in a table to allow the user to see the association between a VLAN ID, MAC address, and its associated IP addresses.</p>
Locked STB MAC Address:	<p>The set of unicast MAC addresses associated with this port.</p> <p>The New Value pull-down allows the user to enter a new valid unicast address. This will overwrite a Current Value if it exists.</p> <p>The Remove option removes the current value and leaves the current Value field blank.</p> <p>Note that several changes (add, change, remove) can be done for the MAC address rows. These changes are activated when the Modify button is pressed.</p>
Clear Entry Fields	Clear any fields that have been datafilled but not yet Modified
Reset IGMP Counters	Enabled if the port is in an Administrative State of DOWN, enables the port and so brings the Administrative State to UP. If possible (for example, the card must be enabled), the Operational State will change to UP.

5.6.31 ATM Bonding

For ATM Bonding, the Service Management Form allows the user to add and remove ports.

Note: To create the ATM Bonding Group, the user should create an ATM Bonding Profile, and then use that Profile as part of provisioning with the Triple Play form. Refer to 5.6.3.4. The result should be an ATM Bonding Group that contains all of its members.

5.6.31.1 Status

The status tab includes the status of the ATM Bond as well as the associated ports. Refer to the following figure.

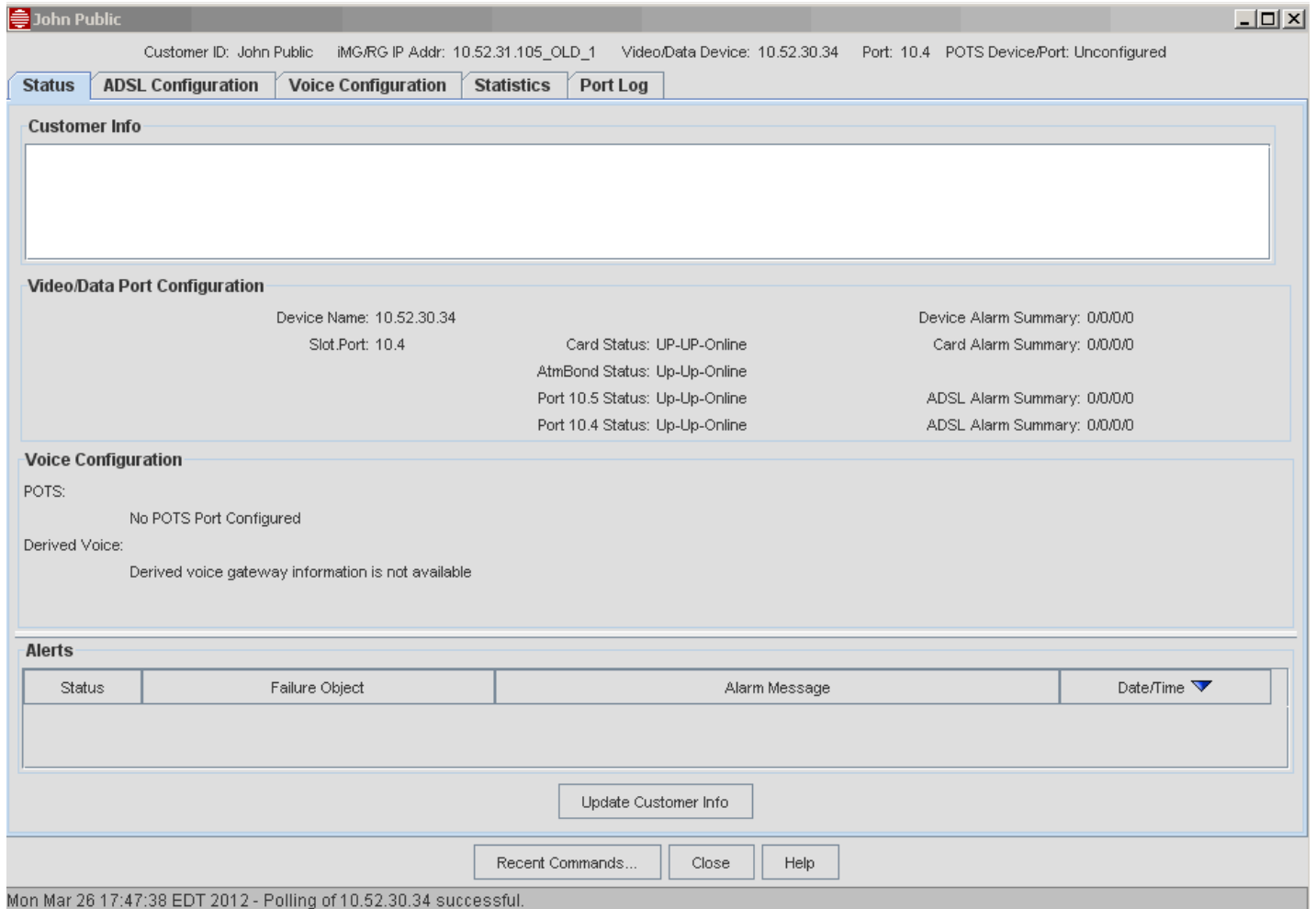

FIGURE 5-198 Status Tab for ATM Bond

5.6.31.2 Bonding Group - Viewing and Changing the Bonding Configuration

The General subtab for ATM Bonded ports gives information on both the ATM Bond and the ADSL members. Refer to the following figure.

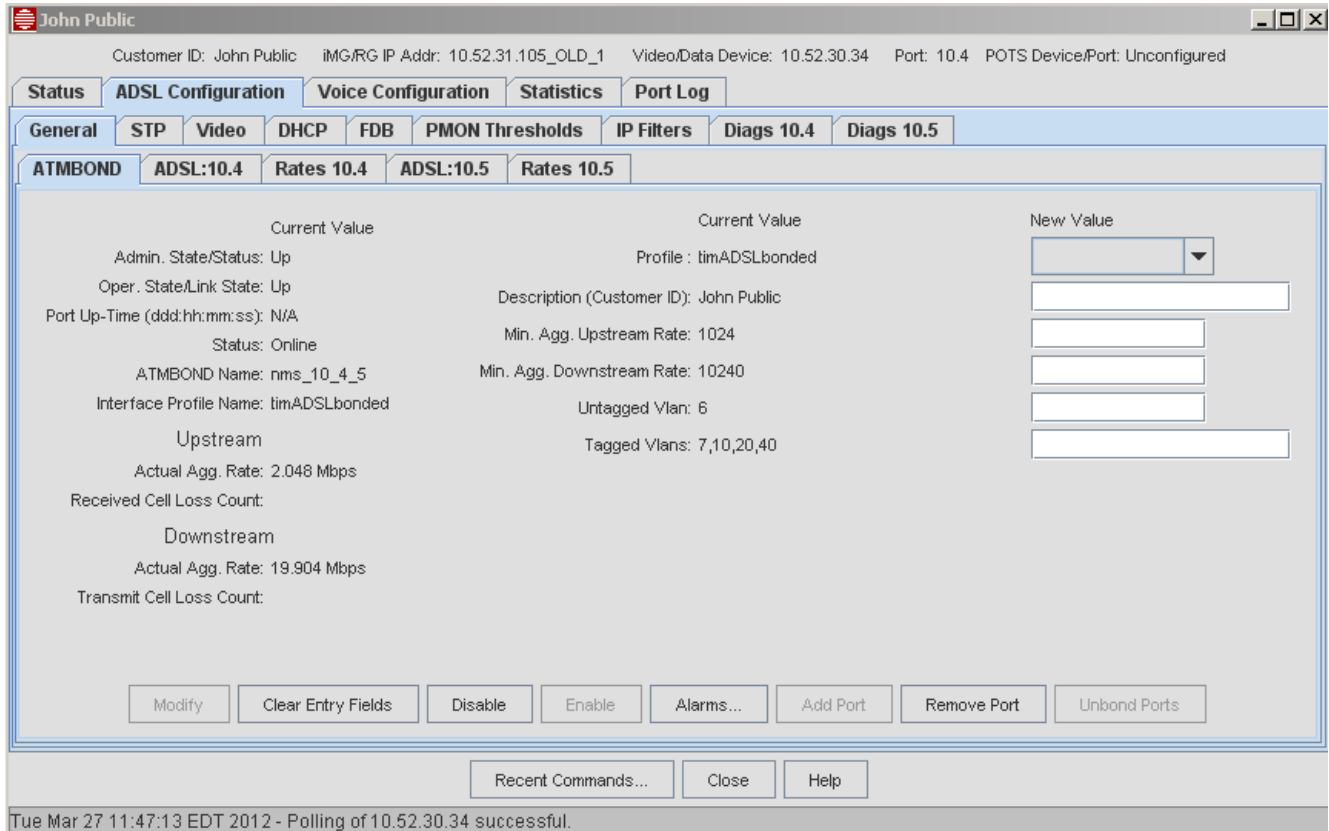
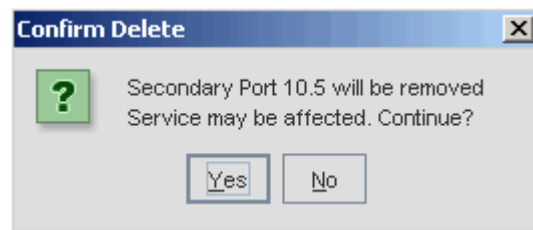

FIGURE 5-199 ATMBOND Tab

From this tab it is possible to enable and disable the ATM Bonding group, as well as add and remove ports to the bond. These options are used as follows:

- **Remove Port** - This allows the user remove the **secondary** port from the ATM Bonding Group, and there is the following warning. Choosing **Yes** drives both the Admin State and the Operational state of the Bonding group to Down.



- **Add Port** - This will retrieve all ports that are not provisioned with a customer (no Customer ID) and open up a window to allow adding another port to the group. (Refer to the following figure.) Choose a port that has the same settings as the principle port (which uses the settings of a bonded Profile). Once the port is added, the port will go to Up-Up. Then press **Enable** (see next item).

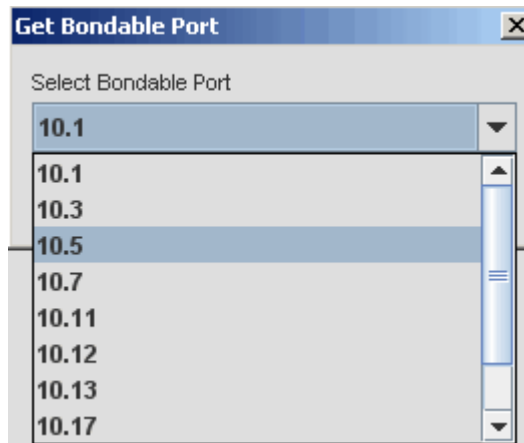

FIGURE 5-200 Selecting a Port to add to Bonding Group

- **Enable** ATM Bonding Group - If the group is disabled, the Enable button is available. Pressing the Enable button drives the ports to an Operational Status of UP, and then sets the ATM Bonding group to UP. At this point Port Management will show the root port as Type ATMBOND and the secondary port will no longer be in the port list. Refer to the following figure.

Port	Type	Customer ID	Status
10.2	ADSL	r634-A	Up
10.3	ADSL		Down
10.4	ATMBOND	John Public	Up
10.6	ADSL	Tim34_1009_Sol	Up
10.7	ADSL	newBond	Down
10.8	ADSL	DSL10_8	Up

FIGURE 5-201 Port is Added to Bonding Group and Deleted in Port Management Table

5.6.31.3 Bonding Group - Viewing and Changing the Port Configuration

Each port in the bonding group has its own Status tab and Rates tab. For the Status tab there are the following options:

- **Disable Port** - From the Port tab, this disassociates the port from the Bonding group. If one port of the two members is disabled, the ATMBOND state goes to Up-Up-Degraded, but the group will continue to be in an UP state. Note that in this scenario the root port could be disabled and the Bonding Group would remain in service (with a Status of Degraded).
- **Enable Port** - This associates the port to the bonding group, and once the port is in an Up-Up state, it will join the Bonding group.

5.6.31.4 De-provision a Port from the Bonding Group

To remove the secondary port from the Group so that it can be used in other applications, use these steps:

1. In the ATM Bond Tab of the Service Management form, select **Remove Port**.
2. Notice that in the Port Management table, the secondary port reappears.
3. In the Port Management table, select the now freed secondary port and select **View/Modify Details**.
4. In the ADSL tab, select **Disable**.

At this point, the port is released from the Group and is added back to the Port Management table, **retaining all of its previous settings**.

Note: The port retains all of its settings, and so you will need to change the settings (preferably through a Profile), if another application requires different settings.

Refer to the following figure.

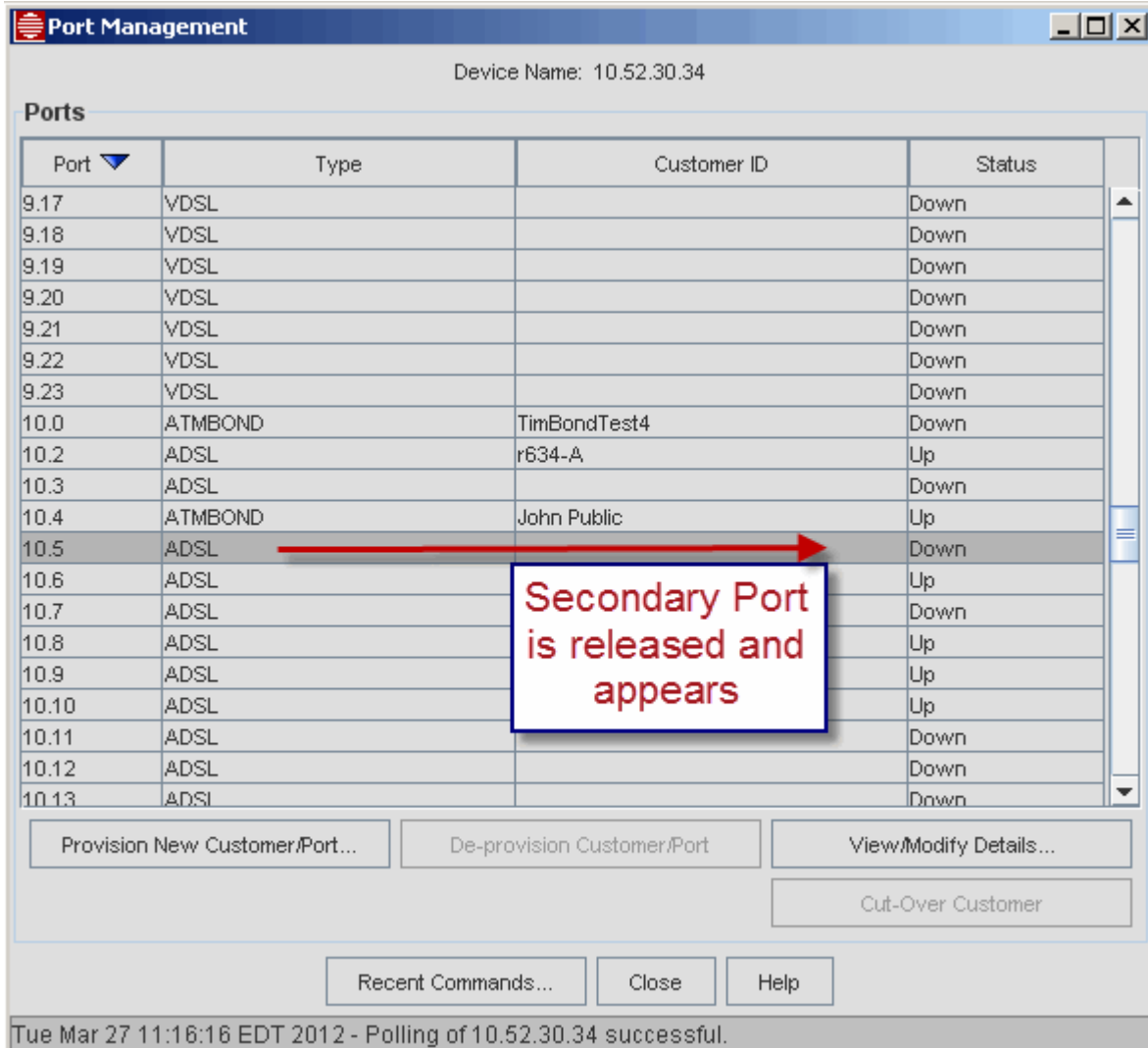

FIGURE 5-202 Secondary Port is Released, can be Provisioned for other Applications

Note: If you close the View/Modify window of an ADSL Bonded port after removing the secondary port (see above), then you cannot reopen the View/Modify window for this ADSL Bonded port again. An error is shown in the JWS console window (Database Error). Therefore, once you have deleted the secondary port and wish to further modify the Bonding configuration (add another port), destroy the ATM Bonding Group (see below) and Re-create the group. Refer to Allied Telesis support for details.

5.6.31.5 Destroying the ATM Bonding Group

To destroy the ATM Bonding Group, go to the primary port in the Port Management table. Select **De-provision Customer Port**, then choose **Select All** and **De-provision**. The Root port goes to Down and can now be provisioned for other applications. Refer to the following figure.

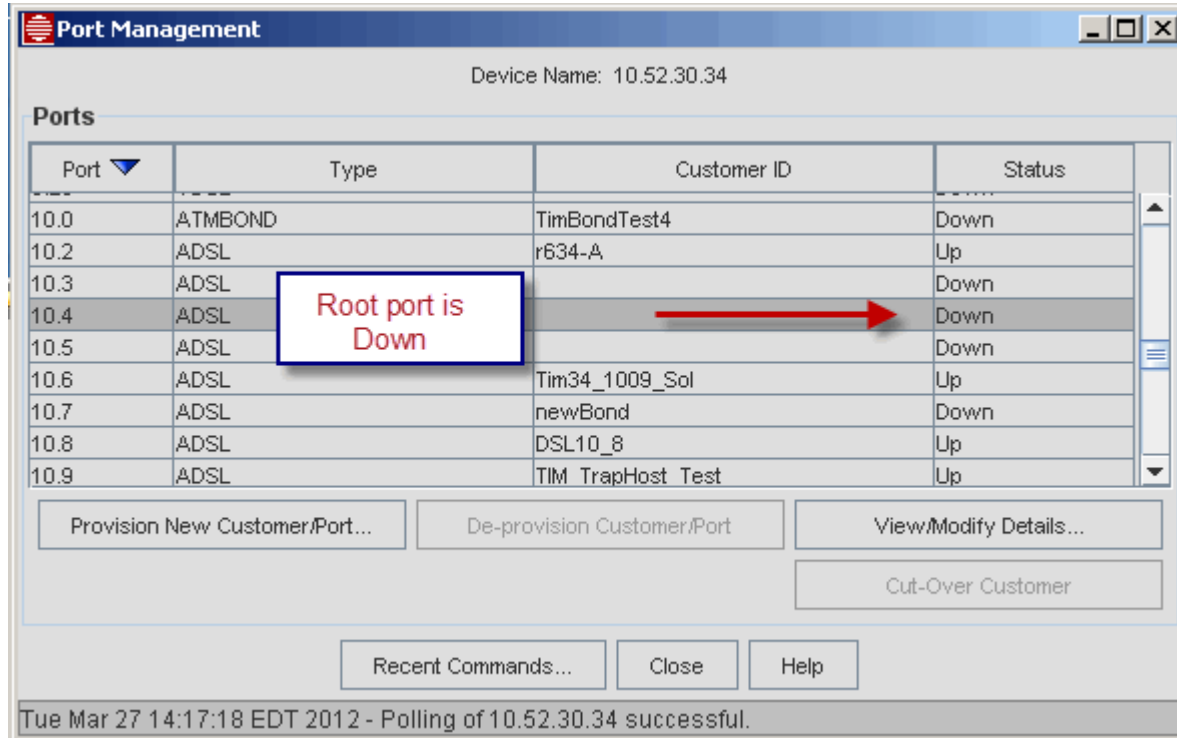

FIGURE 5-203 ATM Bonding Group is Destroyed

Note: If the user selects the Provision New Customer/Port, the system will have a message window that it is selecting all bondable ports. This is only for use if the port is to be part of an ATM Bonding Group; for other applications it is not needed.

5.6.31.6 PMON Thresholds

AtmBond statistics are on a new tab. PMONs can be set for the for each ADSL line. RMONs are tied to the Bond interface. PMON statistics can be collected for each Interface

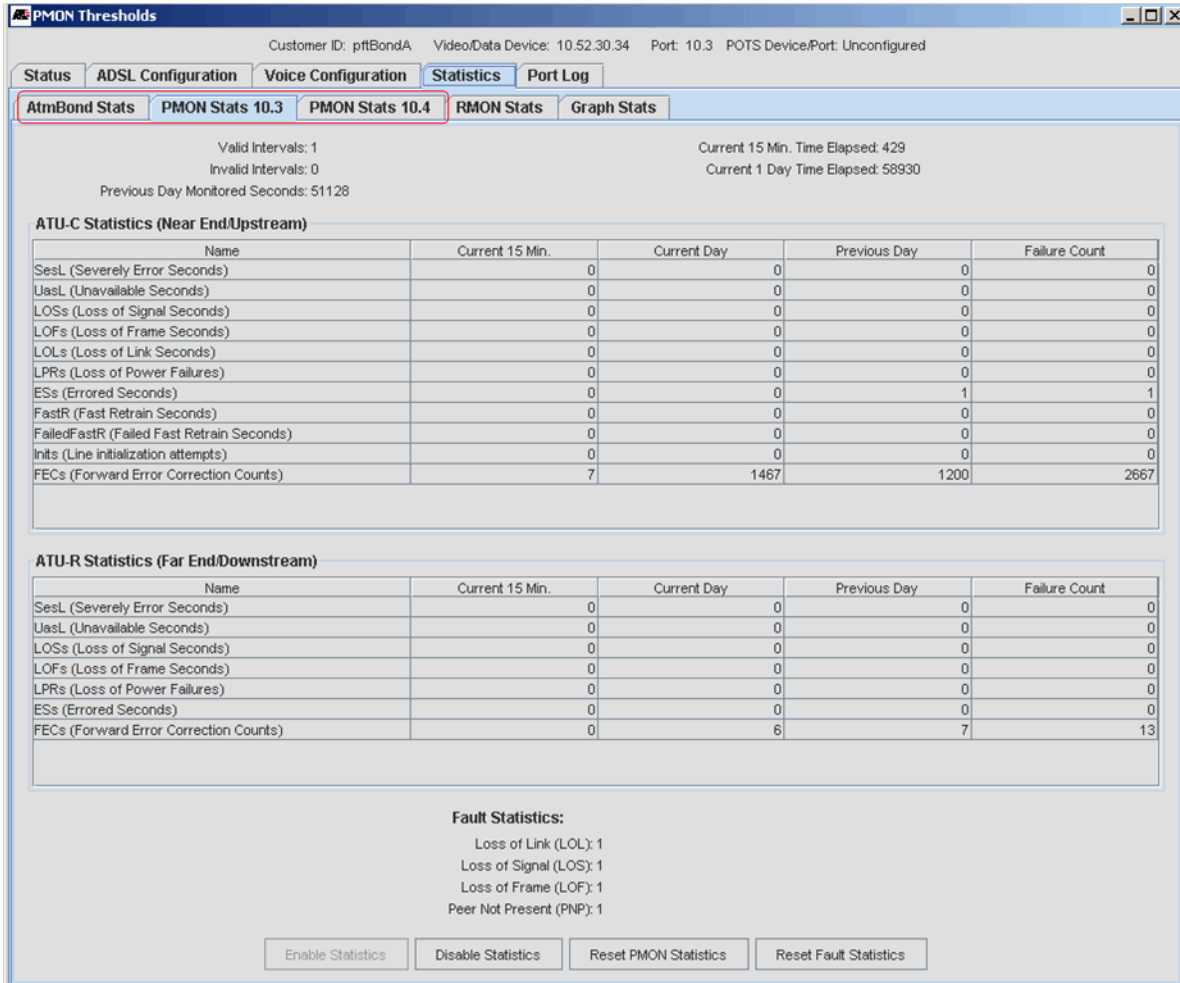

FIGURE 5-204 ATMBOND Statistics

5.6.31.7 Diagnostics

DELT (Dual End Line Test) and SELT (Single End Line Test) can be run on each ADSL port when they are in the appropriate state:

- For DELT that is Up/Up/Showtime
- For SELT Up/Down

Note: These tests may not actually work with the particular modems being used

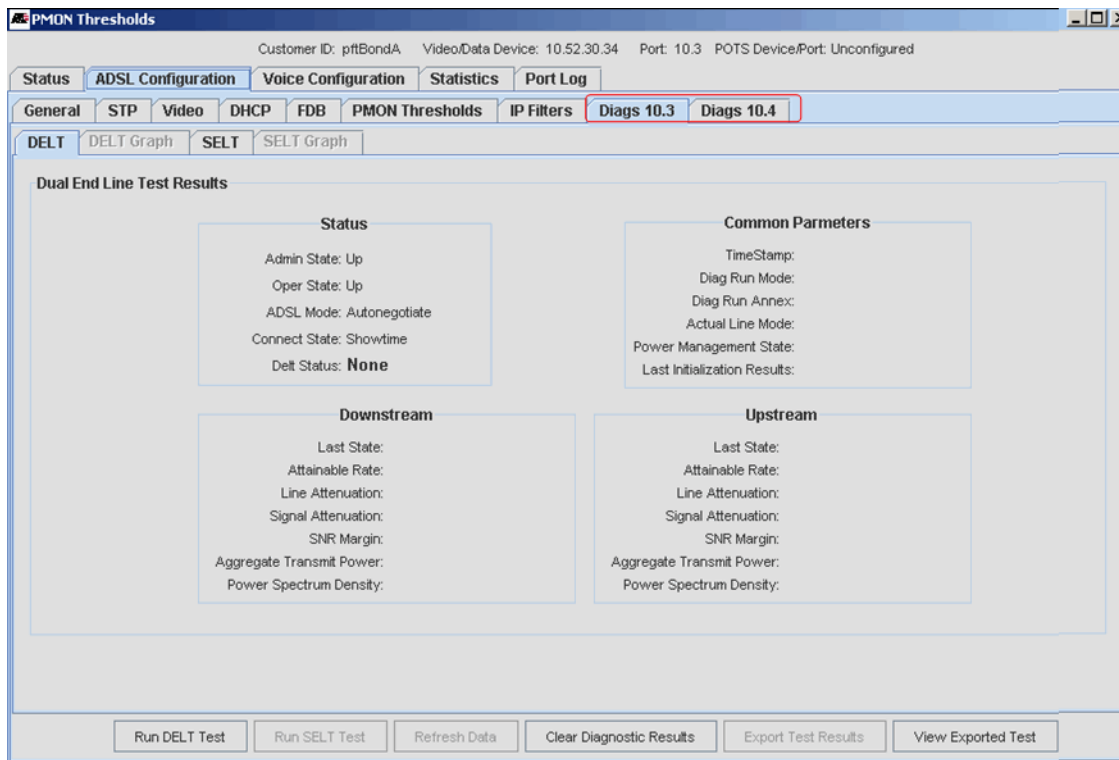

FIGURE 5-205 ATMBOND Diags

5.6.31.8 Network Inventory - Customer Ports

For ATMBOND ports a Managed Object is created to represent the ATMBOND. Its port number is preceded by ‘atmbond:’, and it has the same number as its primary port. Its type is “ATMBOND”. The primary ADSL ports type is changed to “ATMBOND-PRI” and each secondary ADSL port to “ATMBOND-SEC”. All Managed Objects will share the same CustomerID and IfIndex. The ifIndex is for the Ethernet Interface that they all share

Devices	Port	Type	Customer ID	Status	Profile	IfIndex
30.12	1.14	Ether-like		Clear		15
30.1	15	Ether-like		Clear		15
30.1	16	Ether-like		Clear		16
30.12	1.15	Ether-like		Clear		16
30.10	16	Ether-like		Clear		16
30.10	17	Ether-like		Clear		17
30.1	17	Ether-like		Clear		17
30.12	1.16	Ether-like		Clear		17
30.36	17.8	ATMBOND_SEC	pftBond10	Clear		17940498
30.36	17.7	ATMBOND_PRI	pftBond10	Clear		17940498
30.36	atmbond:17.7	ATMBOND	pftBond10	Clear		17940498
30.36	17.9	ATMBOND_PRI	pftBond-2	Clear		17973266
30.36	atmbond:17.9	ATMBOND	pftBond-2	Clear		17973266
30.36	17.10	ATMBOND_SEC	pftBond-2	Clear		17973266
30.12	1.17	Ether-like		Clear		18
30.1	18	Ether-like		Clear		18
30.10	18	Ether-like		Clear		18

FIGURE 5-206 Network Inventory for ATMBOND

5.6.32 STP Tab

For each port configuration tab, there is an STP tab or sub-tab that shows the current STP attributes. Refer to the *iMAP User Guide* for details.

5.7 Port Management (non-iMAP Devices)

As [Table 1-7](#) shows, port management is also provided for the Rapier and Switchblade devices (these include the 8700 and 9800 series).

Note: For complete information on Rapier and Switchblade devices, go to <http://www.alliedtelesis.co.nz/documentation/>

5.7.1 Rapier/Switchblade Devices

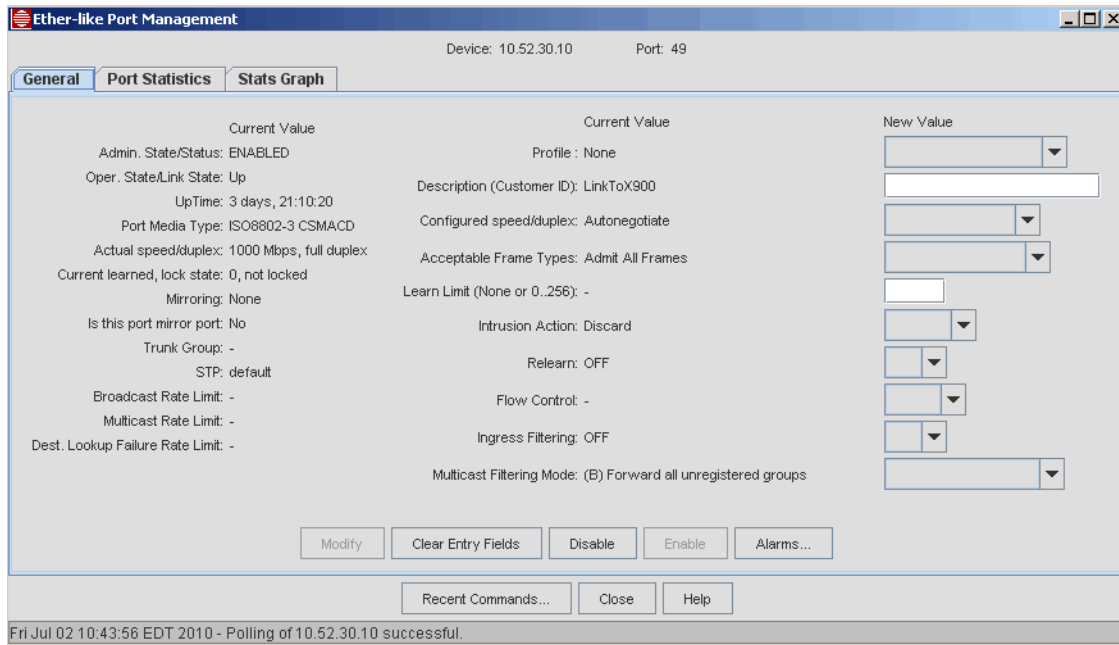

FIGURE 5-207 Ether like Port Management (Rapier Device) - General Tab

TABLE 5-56 Ether-like Port Management for Rapier and SwitchBlade Devices - General Tab

Field/Button	Description
Admin. State/Status:	The Administrative State can be controlled and determines the Operational State. <i>Note:</i> The possible values are ENABLED/DISABLED (rather than the Up/Down for iMAP devices).
Oper. State/Link State:	The ability of the port to provide service. The Administrative State must be Up and then the system determines if the port can provide service. <i>Note:</i> There is no Status field as in iMAP devices. Only the Up/Down values are used.
Other fields	For details on all other fields refer to Allied Telesis documentation.
Modify	Enables the any changes have been made to the settings, makes them
Disable	Disable the port (after a confirmation window). This makes the overall state DOWN.
Enable	Enable the port. This makes the overall STATE UP if the port can be brought into service.
Alarms	Brings up the Alarm view for the selected port.
Clear Entry Fields	Clears the writable fields of any values.

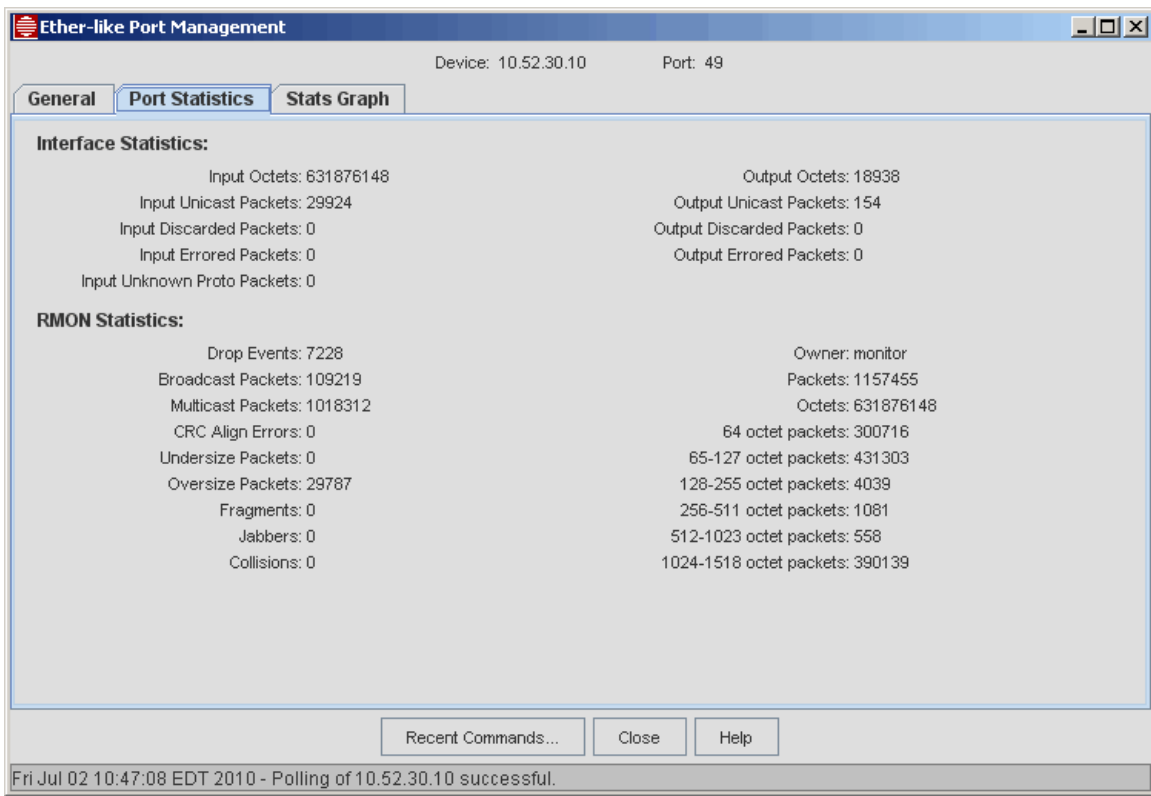

FIGURE 5-208 Ether like Port Management (Rapier Device) - Port Statistics Tab

This form lists the standard RMON statistics.

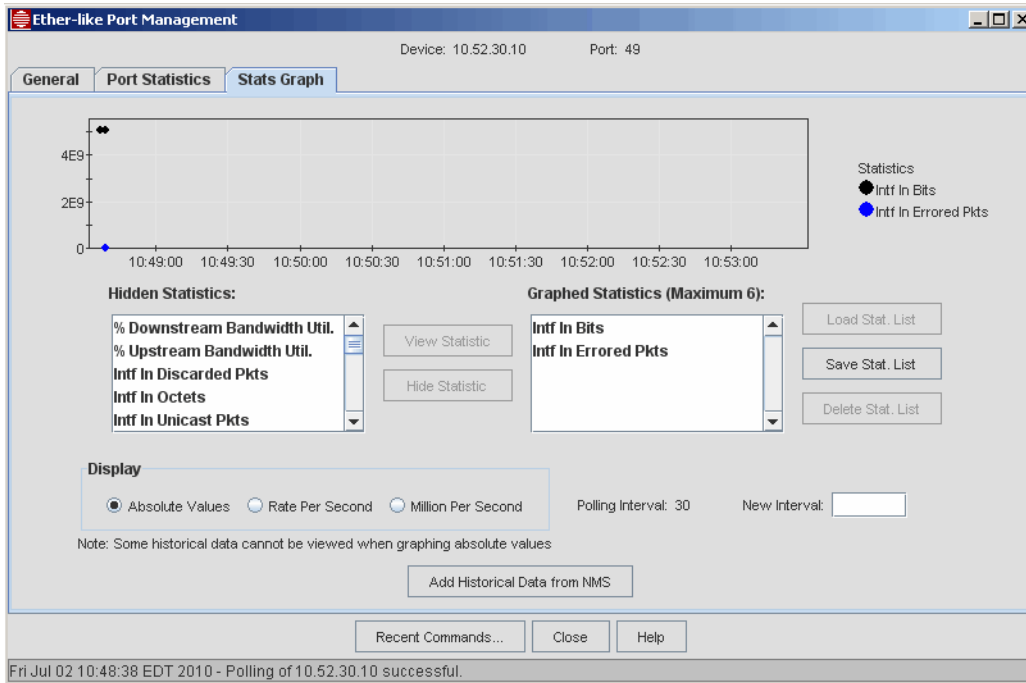

FIGURE 5-209 Ether like Port Management (Rapier Device) - Stats Graph Tab

TABLE 5-57 Provision Port Form for Port Management (Rapier Device) - Stats Graph Tab

Field/Button	Description
Hidden Statistics:	Statistics not added to the resulting graph
View Statistic:	Enabled when a statistic is chosen form Hidden Statistics, clicking this button adds it to the graph/
Hide Statistic:	Enabled when a statistic is chosen form Graphed Statistics, clicking this button deletes it from the graph/
Display	The attribute that controls the display: - Absolute Values - Rate Per Second - Million Per Second
Polling Interval:	Current Polling Interval in seconds
New Interval:	Sets a new interval for polling. This is set with the Reset Polling Interval button.
Add Historical Data from NMS:	Adds the data collected previously from NMS port management
Add Historical Data from Device:	Adds the data collected previously (buckets) from the device

For Switchblade devices, the ether-like port attributes are similar except for the General tab. Refer to the following figure.

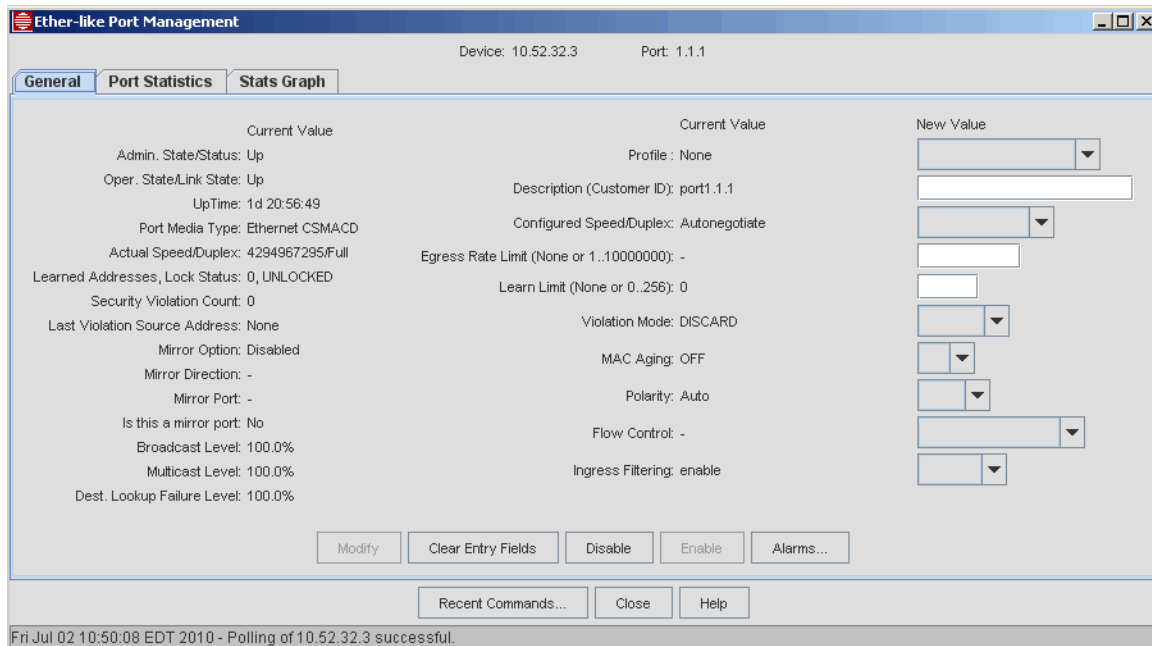

FIGURE 5-210 Ether like Port Management (SwitchBlade Device) - General Tab

Refer to [Table 5-56](#) for a description of the main buttons. For details on all other fields refer to Allied Telesis documentation.

5.7.2 GenBand Reports

5.7.2.1 CPE Reports

This table is accessed by right clicking on the GenBand icon and choosing *Display CPE Report*. This brings up the following figure.

GenBand Name: 10.52.200.110

Name	Domain	IP Addr.	Admin.	Oper.	Version	NTE	Payload	Neg.	Ping
00:00:DA:00:0B:94	rgvoip-0-d-da-0-b-94.lab.tel...	0.0.0.0	Unlock	Disabled	mgcp10ncs10	lcs	on	98	
10.10.10.40	[10.10.10.40]	10.10.10.40	Unlock	Disabled	mgcp10ncs10	lcs	on	98	
10.52.18.61	[10.52.18.61]	0.0.0.0	Unlock	Disabled	mgcp10ncs10	r/c2833	on	98	
10.52.18.95	[10.52.18.95]	0.0.0.0	Lock	Disabled	mgcp10ncs10	lcs	on	98	
10.52.18.142	[10.52.18.142]	10.52.18.142	Unlock	Disabled	mgcp10ncs10	lcs	on	98	
10.52.18.180	[10.52.18.180]	0.0.0.0	Unlock	Disabled	mgcp10ncs10	lcs	on	98	
10.52.30.34_7,0	[10.52.34.3]	0.0.0.0	Unlock	Disabled	mgcp10ncs10	lcs	on	98	
10.52.30.34_7,3	rgvoip-0-dd-da-3-99-2d.nms-t...	0.0.0.0	Unlock	Disabled	mgcp10ncs10	lcs	on	98	
10.52.30.34_7,5	rgvoip-0-d-da-3-e9-af.nms-t...	0.0.0.0	Lock	Disabled	mgcp10ncs10	lcs	on	98	
10.52.30.34_8	[10.52.31.130]	0.0.0.0	Lock	Disabled	mgcp10	lcs	on	98	
10.52.30.34_10,1	rgvoip-0-d-da-5-2a-dd.nms-t...	0.0.0.0	Lock	Disabled	mgcp10ncs10	lcs	on	98	
10.52.30.34_10,2	rgvoip-0-d-da-1-6d-81.nms-t...	0.0.0.0	Unlock	Disabled	mgcp10ncs10	lcs	on	98	
10.52.30.34_10,4	rgvoip-0-d-da-1-85-f1.nms-t...	0.0.0.0	Lock	Disabled	mgcp10ncs10	lcs	on	98	
10.52.30.34_10,6	[192.75.50.50]	0.0.0.0	Lock	Disabled	mgcp10ncs10	lcs	on	98	
10.52.30.35_5,0	rgvoip-0-c-25-15-0-12.nms-t...	10.52.31.164	Unlock	Enabled	mgcp10ncs10	lcs	on	98	
10.52.30.35_5,1	rgvoip-0-10-81-82-83-84.nm...	0.0.0.0	Unlock	Disabled	mgcp10ncs10	lcs	on	98	
10.52.30.35_5,3	rgvoip-0-d-da-1-45-59.nms-t...	10.52.31.184	Unlock	Enabled	mgcp10ncs10	lcs	on	98	
10.52.30.35_5,4	rgvoip-0-d-da-0-2c-5b.nms-t...	0.0.0.0	Unlock	Disabled	mgcp10ncs10	lcs	on	98	
10.52.30.35_5,5	rgvoip-0-d-da-3-9c-42.nms-t...	10.52.31.185	Unlock	Enabled	mgcp10ncs10	lcs	on	98	
10.52.30.35_5,6	rgvoip-0-d-da-3-ce-ea.nms-t...	10.52.31.155	Unlock	Enabled	mgcp10ncs10	lcs	on	98	
10.52.30.35_5,9	rgvoip-0-c-25-1b-0-6.nms-te...	10.52.31.151	Unlock	Enabled	mgcp10ncs10	lcs	on	98	
10.52.30.35_9,1,1	rgvoip-0-d-da-5-7b-1b.nms-t...	0.0.0.0	Unlock	Disabled	mgcp10ncs10	lcs	on	98	
10.52.30.35_10,4	rgvoip-0-d-da-1-93-17.nms-t...	0.0.0.0	Lock	Disabled	mgcp10ncs10	lcs	on	98	
10.52.30.35_10,52	rgvoip-0-d-da-5-7b-9f.nms-t...	10.52.31.161	Unlock	Enabled	mgcp10ncs10	lcs	on	98	8ms, 7ms, 7ms
10.52.30.35_11,0	rgvoip-0-d-da-0-2-d9.nms-te...	10.52.31.175	Unlock	Disabled	mgcp10ncs10	lcs	on	98	
10.52.30.35_11,1	rgvoip-0-d-da-0-2-b2.nms-g...	0.0.0.0	Unlock	Disabled	mgcp10ncs10	lcs	on	98	
10.52.30.35_11,2	rgvoip-0-d-da-a-25-2d.nms.1...	0.0.0.0	Unlock	Disabled	mgcp10ncs10	lcs	on	98	
10.52.30.36_2	[192.168.1.22]	192.168.1.22	Unlock	Disabled	mgcp10	lcs	on	98	
10.52.30.36_18	[10.52.10.10]	10.52.10.10	Unlock	Disabled	mgcp10	lcs	on	98	
10.52.30.36_21	[192.168.1.32]	192.168.1.32	Unlock	Disabled	mgcp10	lcs	on	98	
10.52.68.70_8	[10.168.1.75]	10.168.1.75	Unlock	Disabled	mgcp10	lcs	on	98	
10.52.68.80_21	[10.168.1.50]	10.168.1.50	Unlock	Disabled	mgcp10	lcs	on	98	
10.52.110.22_0,0	rgvoip-0-d-da-3-af-59.rgvoi...	10.52.111.188	Unlock	Enabled	mgcp10ncs10	lcs	on	98	
10.52.110.22_0,1	rgvoip-0-d-da-3-a9-0.rgvoi...	10.52.111.189	Unlock	Enabled	mgcp10ncs10	lcs	on	98	
10.52.110.22_0,3	rgvoip-0-c-25-15-0-28.rgvoi...	0.0.0.0	Unlock	Enabled	mgcp10ncs10	lcs	on	98	
10.52.110.22_1,0	rgvoip-0-d-da-5-7a-d3.rgvoi...	10.52.111.181	Unlock	Enabled	mgcp10ncs10	lcs	on	98	

FIGURE 5-211 GenBand CPE Report

This table provides the values for the GenBand connection to the CPE and includes:

- CPE Name - When provisioned by the NMS, includes the IP address of the associated iMAP and port.
- Domain - This is explained in section 7, and must be provisioned for voice service to work. If the value is only an IP address, the value has been manually configured.
- IP Addr. - This is the voice IP address of the iMG
- Admin - This controls whether the CPE can be brought into service.
- Oper. - The actual state of the CPE. It can be Enabled only if the Oper. State is Unlock
- Version - The mgcp protocol version
- NTE - Whether the GenBand uses inband (lcs) or out-of-band (ncs) control of mgcp. This is usually lcs.
- Ping results - This is the result of selecting the Start Ping Test on a row

5.7.2.2 Line Reports

This table is accessed by right clicking on the GenBand icon and choosing *Display Line Report*. This brings up the following figure.

This table provides information down to the individual connection and also has a ping feature. Refer to the following figure.

GenBand Line Report

GenBand G6 Name: 10.52.200.110

Line Entries

CPE Name	Cust. ID	Domain	Line #	Admin.	Oper. State	IG Type	IG	CRV	Ping
00:0D:DA:00:0B:94	cavaller - joe on th	rgvoip-0-d-da-0-b-94.lab1...	0	Unlock	Disabled-ANM	gr303	spsi	25	Invalid Host/IP Address
10.10.10.40	TEST ONE	10.10.10.40	0	Unlock	Disabled-BOTH	gr303	abc	2048	failure, failure, failure
10.10.10.40	TEST ONE	10.10.10.40	1	Unlock	Disabled-BOTH	gr303	abc	2047	failure, failure, failure
10.52.18.142		10.52.18.142	0	Unlock	Disabled-ANM	gr303	gr303	29	
10.52.30.34_10.2	User2	rgvoip-0-d-da-1-6d-81.nm...	0	Unlock	Disabled-ANM	gr303	gr303	46	
10.52.30.35_5.0	HPNA_pete	rgvoip-0-c-25-15-0-12.nm...	0	Unlock	Enabled	gr303	gr303	1	
10.52.30.35_5.3	keith	rgvoip-0-d-da-1-45-59.nm...	0	Unlock	Enabled	gr303	gr303	17	
10.52.30.35_5.4	John Jones	rgvoip-0-d-da-0-2c-5b.nm...	0	Unlock	Disabled-ANM	gr303	gr303	19	
10.52.30.35_5.5	Smith	rgvoip-0-d-da-3-9c-42.nm...	0	Unlock	Enabled	gr303	gr303	48	
10.52.30.35_5.5	Smith	rgvoip-0-d-da-3-9c-42.nm...	1	Unlock	Enabled	gr303	gr303	49	
10.52.30.35_5.6	User4	rgvoip-0-d-da-3-ce-aa.nm...	0	Unlock	Enabled	gr303	gr303	7	
10.52.30.35_5.9	Asimo	rgvoip-0-c-25-1b-0-6.nms...	0	Unlock	Disabled-ANM	gr303	gr303	16	
10.52.30.35_5.9	Asimo	rgvoip-0-c-25-1b-0-6.nms...	1	Unlock	Disabled-ANM	gr303	gr303	18	
10.52.30.35_9.1.1	21844499595	rgvoip-0-d-da-5-7b-1b.nm...	0	Unlock	Disabled-ANM	gr303	gr303	36	
10.52.30.35_10.52	EPON Customer	rgvoip-0-d-da-5-7b-9f.nm...	1	Unlock	Enabled	gr303	gr303	14	
10.52.30.35_11.1	Cust2	rgvoip-0-d-da-0-2-b2.nms...	0	Unlock	Disabled-ANM	gr303	gr303	20	
10.52.30.35_11.1	Cust2	rgvoip-0-d-da-0-2-b2.nms...	1	Unlock	Disabled-ANM	gr303	gr303	47	
10.52.30.35_11.2	CustBG	rgvoip-0-d-da-a-25-2d.nm...	0	Unlock	Disabled-ANM	gr303	gr303	59	
10.52.30.35_11.2	CustBG	rgvoip-0-d-da-a-25-2d.nm...	1	Unlock	Disabled-ANM	gr303	gr303	60	
10.52.30.35_11.2	CustBG	rgvoip-0-d-da-a-25-2d.nm...	2	Unlock	Disabled-ANM	gr303	gr303	61	
10.52.30.35_11.2	CustBG	rgvoip-0-d-da-a-25-2d.nm...	3	Unlock	Disabled-ANM	gr303	gr303	62	
10.52.30.35_11.2	CustBG	rgvoip-0-d-da-a-25-2d.nm...	4	Unlock	Disabled-ANM	gr303	gr303	63	
10.52.30.35_11.2	CustBG	rgvoip-0-d-da-a-25-2d.nm...	5	Unlock	Disabled-ANM	gr303	gr303	64	
10.52.30.35_11.2	CustBG	rgvoip-0-d-da-a-25-2d.nm...	6	Unlock	Disabled-ANM	gr303	gr303	65	
10.52.30.35_11.2	CustBG	rgvoip-0-d-da-a-25-2d.nm...	7	Unlock	Disabled-ANM	gr303	gr303	66	
10.52.30.36_2	sdrADSL8	192.168.1.22	0	Unlock	Disabled-BOTH	gr303	abc	900	failure, failure, failure
10.52.30.36_2	sdrADSL23	192.168.1.22	11	Unlock	Disabled-BOTH	gr303	abc	911	failure, failure, failure
10.52.30.36_2	sdrVDSL8	192.168.1.22	12	Unlock	Disabled-BOTH	gr303	abc	912	failure, failure, failure
10.52.30.36_2	sdrVDSL9	192.168.1.22	13	Unlock	Disabled-BOTH	gr303	abc	913	failure, failure, failure
10.52.30.36_2	sdrVDSL11	192.168.1.22	15	Unlock	Disabled-BOTH	gr303	abc	915	failure, failure, failure
10.52.30.36_2	sdrVDSL12	192.168.1.22	16	Unlock	Disabled-BOTH	gr303	abc	916	failure, failure, failure
10.52.30.36_2	sdrVDSL13	192.168.1.22	17	Unlock	Disabled-BOTH	gr303	abc	917	failure, failure, failure
10.52.30.36_2	sdrVDSL14	192.168.1.22	18	Unlock	Disabled-BOTH	gr303	abc	918	failure, failure, failure
10.52.30.36_2	sdrVDSL15	192.168.1.22	19	Unlock	Disabled-BOTH	gr303	abc	919	failure, failure, failure
10.52.30.36_2	sdrADSL22	192.168.1.22	1	Unlock	Disabled-BOTH	gr303	abc	910	failure, failure, failure
10.52.30.36_2	sdrTestUpgradedPO...	192.168.1.22	2	Unlock	Disabled-BOTH	gr303	abc	506	failure, failure, failure
10.52.30.36_2	sdrADSL11	192.168.1.22	3	Unlock	Disabled-BOTH	gr303	abc	903	failure, failure, failure
10.52.30.36_2	sdrADSL12	192.168.1.22	4	Unlock	Disabled-BOTH	gr303	abc	904	failure, failure, failure
10.52.30.36_2	sdrADSL13	192.168.1.22	5	Unlock	Disabled-BOTH	gr303	abc	905	failure, failure, failure

Refresh Stop Customer ID Collection Start Ping Test Stop Ping Test Recent Commands... Close Help

FIGURE 5-212 GenBand Line Report

5.7.3 Dual End Line Testing (DELT)

5.7.3.1 Overview of DELT

DELT provides information about the quality of the link between the ADSL card and the modem by collecting upstream and downstream values for attainable rate, line attenuation, signal attenuation, signal-to-noise margin, power spectrum density, and aggregate transmitted power. DELT diagnostics are conducted over a low bit rate channel between the iMAP and the CPE and can therefore be executed in extremely degraded cases where the ADSL link cannot train up.

The data collected is based on recommendations of ITU G.997.1 section 7.5.

In addition to line-level attributes, DELT tests also collect signaling information on a sub-carrier basis. For ADSL, there are 512 sub-carriers per line. The sub-carrier data can be graphically displayed to show the characteristics of the line. The graph, in conjunction with signaling templates, can reveal the source or sources of line interference.

For provisioning, note the following:

- This feature works with the xDSL family (ADSL24A, ADSL24B, ADSL48A, ADSL48B, ADSL24SA, VDSL, PAC24A, ADSL24AE) of cards.
- DELT results are only available if the service module and modem are configured to support one of the ADSL2 modes.
- Not all ADSL2 and ADSL2+ modems support DELT. Running DELT diagnostics on a modem that is not DELT capable will result in a DELT test failure. Since DELT is a relatively new capability, interoperability issues exist with some CPE devices. These issues can cause DELT diagnostics to fail, or in some cases, cause DELT to report incorrect results. Allied Telesis will publish a list of CPE (hardware and software versions) that have been verified for proper DELT operation.

Note: The ability for the iMAP to run DELT is from release 9.0, while the NMS DELT feature is for NMS release 10.0. Therefore, this NMS feature can be run on an iMAP running a 9.0 load, although there are some additional DELT features for iMAP 10.0.

5.7.3.2 Accessing DELT

From the Port Management application select an active ADSL port one of the supported card types. Select the **ADSL Configuration** tab, then the **Diagnostics** tab. If the tab is not present then the port does not support DELT. Then select the **DELT** tab, as shown in the following figure. If there is existing data from a previous DELT the fields are populated and the **DELT Graph** tab will be active. If there was no previous DELT the **DELT Graph** tab will be inactive and grayed out.

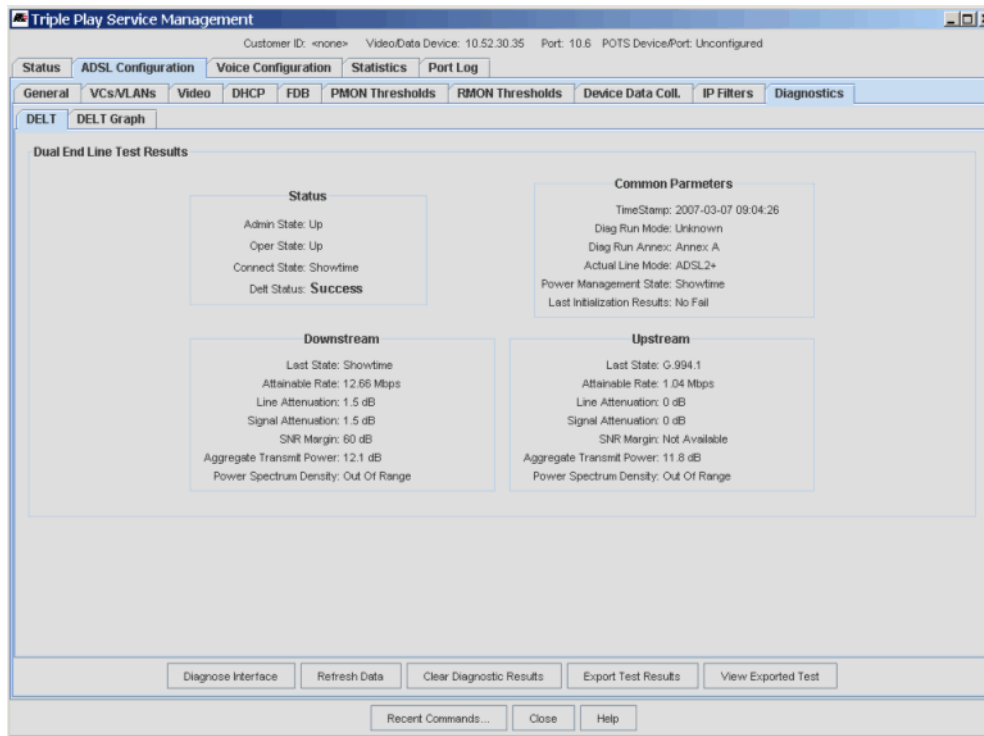

FIGURE 5-213 DELT Testing Tab

5.7.3.3 Initiate a DELT Diagnostic

Clicking the **Diagnose Interface** button will initiate a DELT. A confirmation dialog box appears indicating that service may be disrupted, if confirmed the ATI activity dialog appears until the test starts. While running, all the buttons are disabled except for **View Exported Test**. The “DEL T Status” field indicates “Running” or “In Progress” while the test is running. When successfully completed the basic result values will populate the fields, the **DEL T Graph** tab will be activated, and all the buttons will be enabled.

5.7.3.4 Retrieve DELT Results

DELT results are automatically retrieved when the **DEL T** tab is selected, and after a successful DELT test. Clicking the **Refresh Data** button will re-retrieve this data, along with the current mode of the port. If the port Mode is unknown, due to the port retraining after the last test, this will also update that field.

5.7.3.5 Graph DELT Result

When DELT results exist the **DEL T Graph** tab is activated. Selecting it will display the following screen. Initially all parameters are in the left window and none are graphed. Selecting one or more and clicking the **View Parameter** button will move it into the right “Graphed Parameters” list and draw a graph of its data. The color of the line used is shown next to the graphed parameter name. (To remove a parameter, select one or more in the “Graphed Parameters” list and click the **Remove Parameter** button.

The same parameters are available for both upstream and downstream directions, though different numbers of sub carriers are available based on the actual mode of the port. Selecting a different direction will clear the graph, move all parameters back the available list, and switch the data to the selected direction.

Clicking the **Refresh Data** button will recollect the data from the iMAP just as it does on the **DEL T** tab. This will only have an effect if the mode of the port changes or if a new DELT was run, or the results cleared, outside of the NMS.

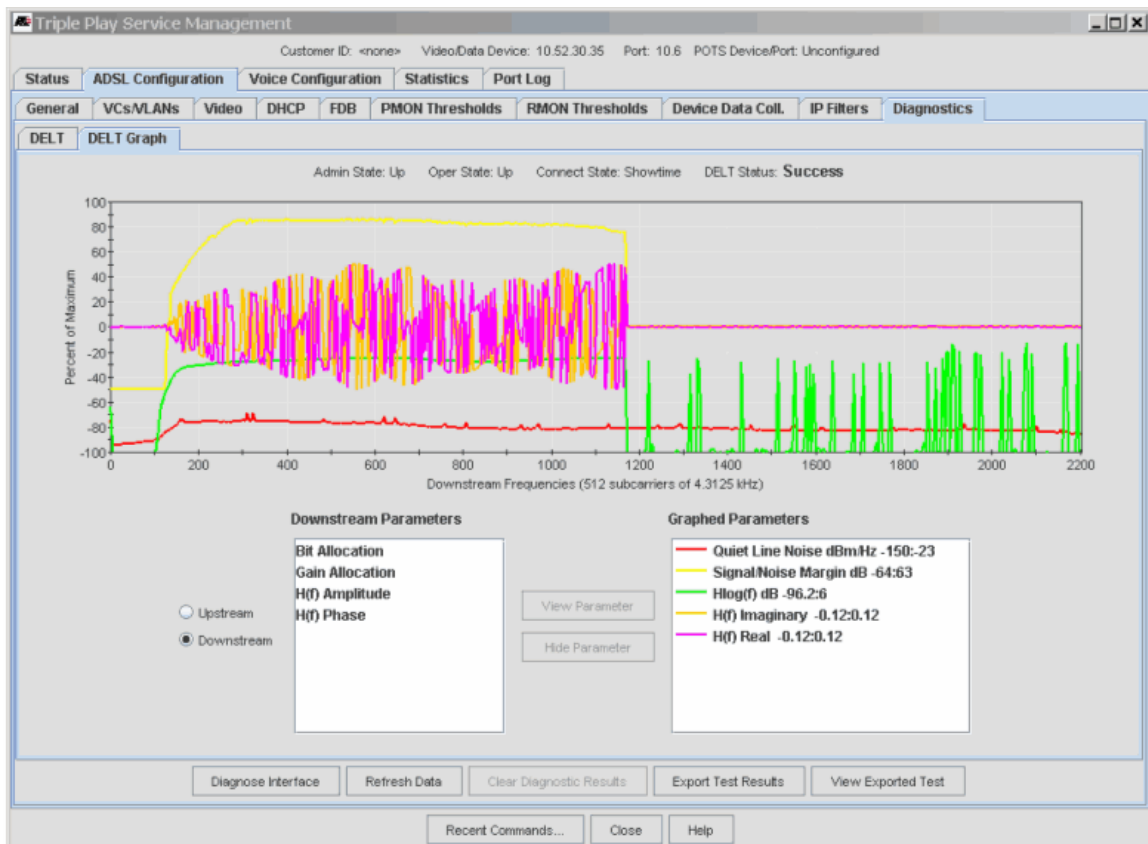

FIGURE 5-214 Graph of DELT Parameter Results

5.7.3.6 Export DELT Results to a File

Clicking the **Export Test Results** button displays an export dialog similar to the one used for exporting other data from the NMS. Data is stored on the NMS server. If the **File Chooser** button is clicked, you can navigate to a directory on the server and select an existing file or create a new one. When the **OK** button on the export dialog is clicked the data is stored on the NMS server in the indicated file.

Note: If the test is from an iMAP running 9.x, the timestamp is set to the time the results are saved. When the test is viewed, this time is shown as the timestamp value.

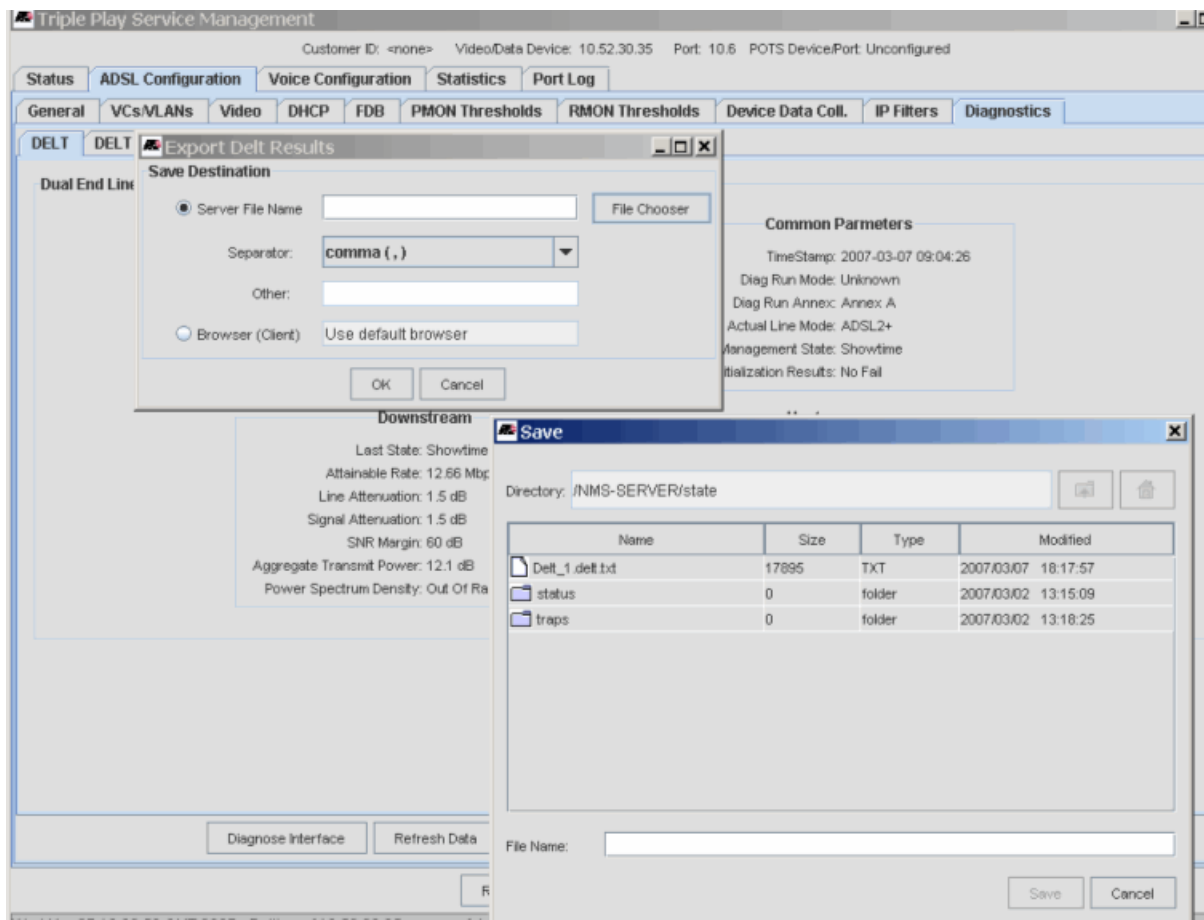

FIGURE 5-215 Exporting DELT Results to a File

5.7.3.7 Export DELT Results to Web Page

As with other export operations, the data can optionally be exported to an HTML page and viewed with a browser. The page can then be saved using the browser.

After a file is selected the test result viewer is displayed. The viewer window also has a **View Exported Test** button so that additional tests can be displayed and compared. A maximum of eight (8) tests can viewed simultaneously from a single client, in addition to the port details window. Refer to the following figure.

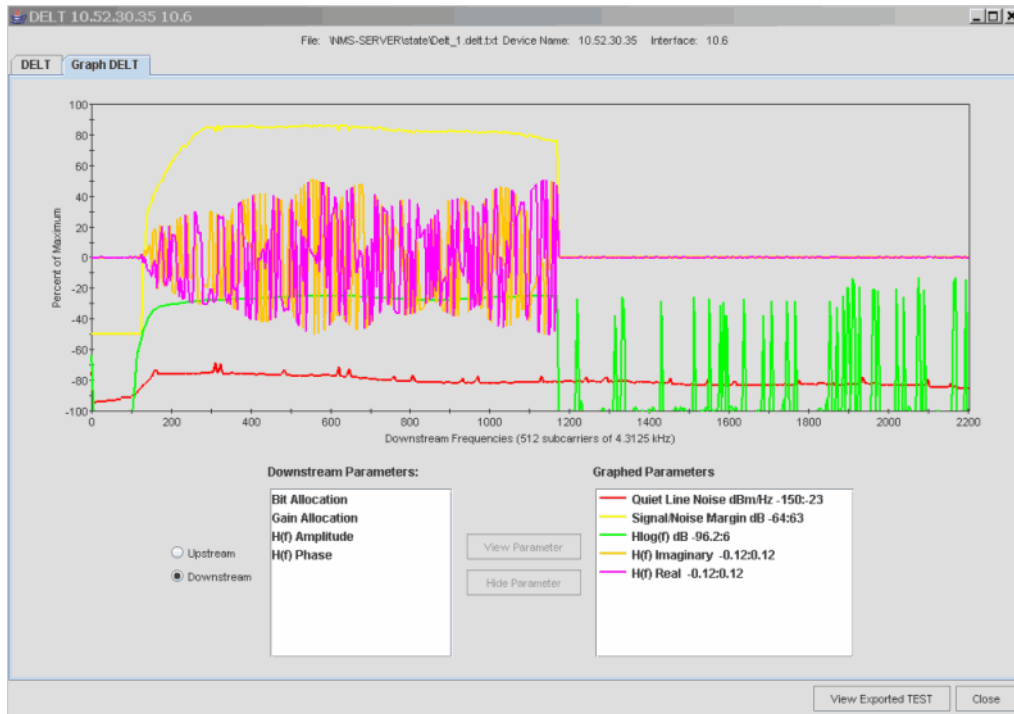

FIGURE 5-218 View Graph Results

5.7.3.9 Graphed Parameters

- Subcarriers - The same values are available for both upstream and downstream directions. Depending on the type of port and actual mode of operation different subcarrier counts are used. The following table describes the possible values

TABLE 5-58 Values for Subcarriers

Card Types	Actual Standard	Actual Annex	Upstream Carriers	Downstream Carriers
VDSL24A, VDSL24B			512	512
ADSL24A/B, ADSL24AE ADSL48A, ADSL48B,	ADSL2, ADSL2M	ANNEXB, ANNEXM	64	256
		others	32	256
	ADSL2+ ADSL2+M	ANNEXB, ANNEXM	64	512
			32	512

- Bit Loading - Bits allocated per sub channel. Range is 0 to 15.
- Gain - Range is 0 - 4093/512.
- Quiet Line Noise - Noise on quiet line. Range is -150 to -23 db/MHz.
- Signal/Noise Margin - The signal-to-noise ratio margin per band is the maximum increase in dB of the noise power received at the xTU-R, such that the BER requirements are met for all bearer channels. The range is from -64 dB to +63 dB with 0.1 dB steps.
- Hlog(f) - The log of the characteristic function

- H(f) Imaginary - The imaginary component of the characteristic function.
- H(f) Real - The real component of the characteristic function.
- H(f) Amplitude - The amplitude of the characteristic function. This is computed from the real and imaginary components. $Amp = \sqrt{r^2 + i^2}$ where r is the real component and i the imaginary component.
- H(f) Phase - The phase of the characteristic function. This is computed from the real and imaginary components. $Phase = \arctan(i/r)$ where r is the real component and i the imaginary component.

5.7.4 Single-End Line Testing (SELT)

5.7.4.1 Overview of SELT

SELT is a method for testing a DSL loop that is **not** terminated at the CPE. These tests provide for the loop information on the length, the presence of open or short circuits, and estimates of pre-service capacity.

SELT testing is usually done in the following scenarios:

- Pre-CPE Installation - The loop exists, but not at the CPE. SELT can test the line for physical bridge and loop taps.
- Pre-CPE Activation - SELT can characterize the loop and measure loop noise. The information can be used to determine maximum rates.
- Post Activation - If there is a problem, the characterization of the loop can be compared to the results of the pre-CPE activation to see if there are any changes.

This feature works with the xDSL family (ADSL24A, ADSL24B, ADSL24SA, ADSL24AE, ADSL48A, and ADSL48B) of cards. (VDSL cards will be supported in a future release.)

SELT sessions are limited to a single session at a time due to the amount of time (up to four minutes) each test can take to complete and the resources needed to execute the test.

For accurate results, loops up to 9000 feet can be tested. Using the FULL options allows loops up to 12,000 feet can be tested. Limits are as follows:

Annex B support is limited to 24 AWG loops. 26 AWG wiring is not supported and will produce erroneous results

The port/interface to be tested must be in operationally down: UP-DN-Failed. The state life-cycle for the port/interface under test will be: UP-DN-Failed to start the test, UP-DN-In Test for the duration of the test and will be transitioned back to UP-DN-Failed once testing has completed.

Refer to the *iMAP User Guide* for details on SELT testing.

5.7.4.2 Accessing SELT

From the Port Management application select an active ADSL port one of the supported card types. Select the **ADSL Configuration** tab, then the **Diagnostics** tab. If the tab is not present then the port does not support SELT. Then select the **SELT** tab, as shown in the following figure. If there is existing data from a previous SELT the fields are populated and the **SELT Graph** tab will be active. If there was no previous SELT the **SELT Graph** tab will be inactive and grayed out.

To run SELT, select the **Run SELT Test** button. A panel appears with the options for the test. Refer to the following figure.

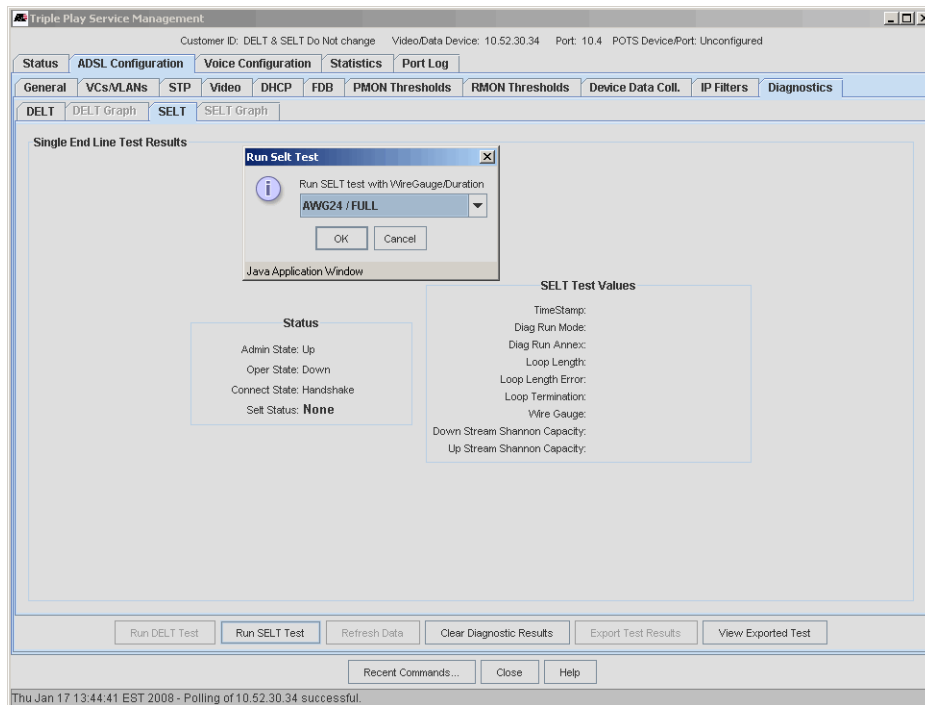

FIGURE 5-219 Running the SELT Test

Select OK, and the test will begin. As it goes through testing, the state will change, until the test is complete and with a status of Success. Refer to the following figure.

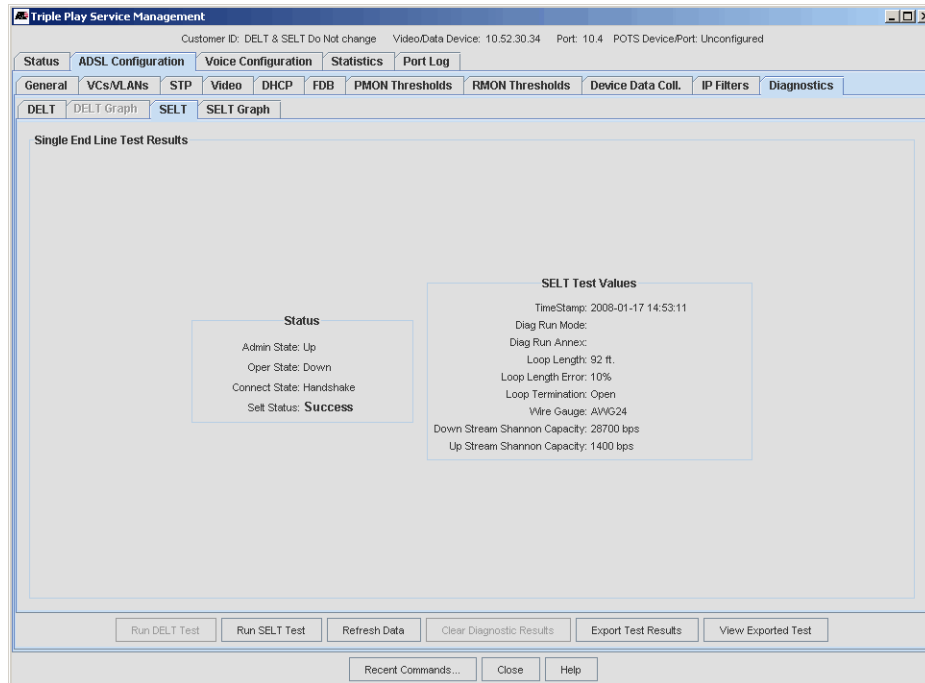

FIGURE 5-220 SELT Test Complete

Once the test is complete, the user can view the results on a browser or save the test results for later analysis. The interface to review test results is similar to those used for DELT and is described in 5.7.3.

5.7.5 Diagnostics for ATMBOND

DELT (Dual End Line Test) and SELT (Single End Line Test) can be run on each ADSL port when they are in the appropriate state:

- For DELT that is Up/Up/Showtime
- For SELT Up/Down

Note: These tests may not actually work with the particular modems being used

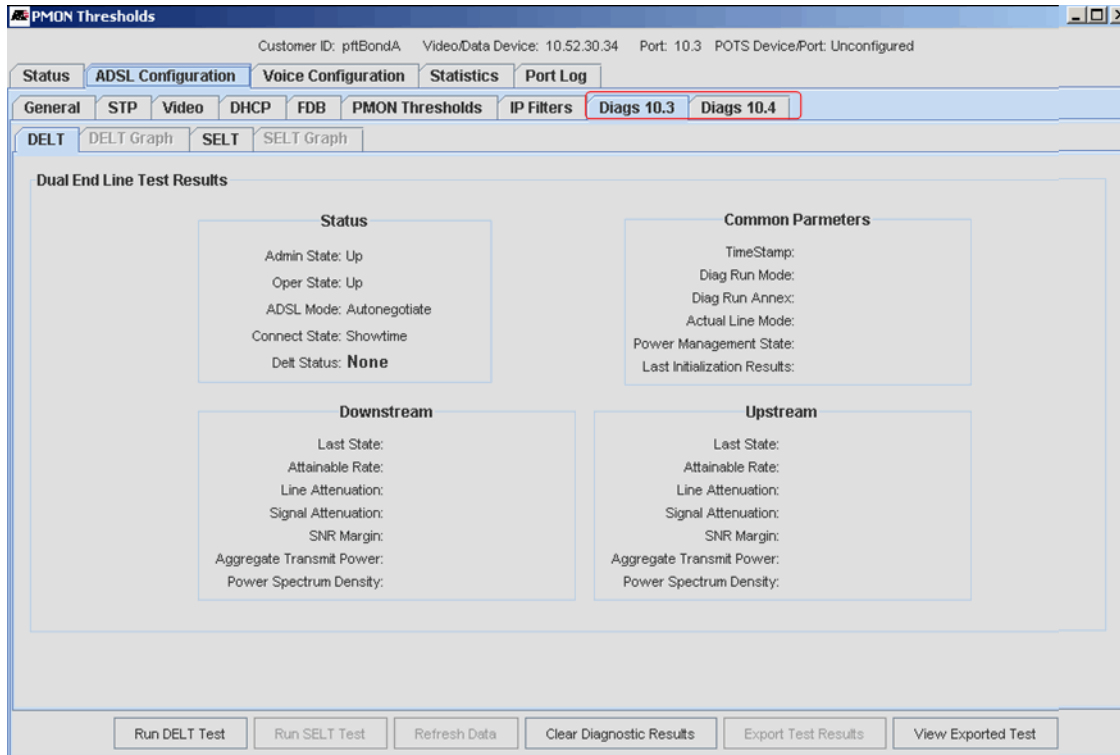

FIGURE 5-221 ATMBOND Diags

5.7.6 Support of CWMP with TR-069 Devices

Caution: *Due to inter operability problems, do NOT use the TR-069 CPE WAN Management Protocol (CWMP) to manage Comtrend 5631 CPE. Otherwise, service may be interrupted. Instead, use the Comtrend web GUI for configuration and management. Contact your ATI representative for details.*

5.7.6.1 Overview

Support of CWMP with TR-069 provides:

- The CPE Wan Management Protocol (CWMP) TR-069 framework is supported.
- Basic support for the Comtrend 5631 CPE device.

This Comtrend device supports bonded ports where multiple ADSL lines are combined (bonded) together and connected to one CPE device to allow higher throughput rates for the individual customer using the CPE. The feature to support provisioning bonded ports (G.bond) is already supported in the NMS release, and is described in 5.6.31. This NMS feature is expected to be used to configure the iMAP ports where the Comtrend CPE is connected. Refer to the following figure, keeping in mind the following provisioning guidelines:

- The G.bond feature requires support for up to two (2) ADSL bonded ports.
- Unlike the SHDSL wire-pair bonding implementation which requires the bonded ports to be adjacent, G.bond allows for any two ports to bond together as long as they exist on the **same card**.

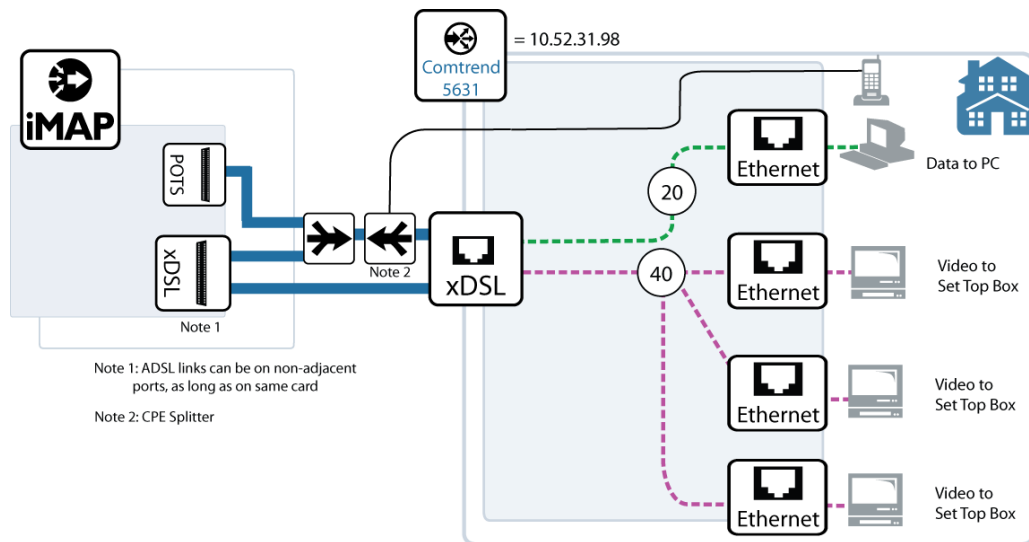

FIGURE 5-222 Comtrend Configuration (Bonded ADSL)

5.7.6.2 Basic Functions

The following functions are provided:

- Provisioning of the Comtrend device using the NMS

Video and internet services can be provisioned using the NMS Triple-Play GUIs, using TR-069. Existing Profiles can be used with the Comtrend CPE as with other iMG/RGs.

- Backup and Restore

The Comtrend configuration files can be backed up and restored as with other CPE devices.

- Display and modify device information using the Multi-device Table Interface (MDTI) applications

The Comtrend CPE is added.

Note: Although there is now support for provisioning the Comtrend using the NMS, there are limitations, since some components supported by the NMS are not yet implemented in the Comtrend CPE, and the Comtrend CPE does not fully support TR-069 and related specifications. This is explained through the rest of this Section.

Support for this device includes:

- Viewing Managed Object Properties
- Provisioning a new customer/CPE
- Initiate device rediscovery
- De-provision customer/CPE
- Remove Profile association
- Monitoring operations (Alarms/Events)
- Providing access to provision the device through
 - a browser to access the device web server
 - telnet to allow CLI

The following figure shows the menu options available (right-click device in Inventory)

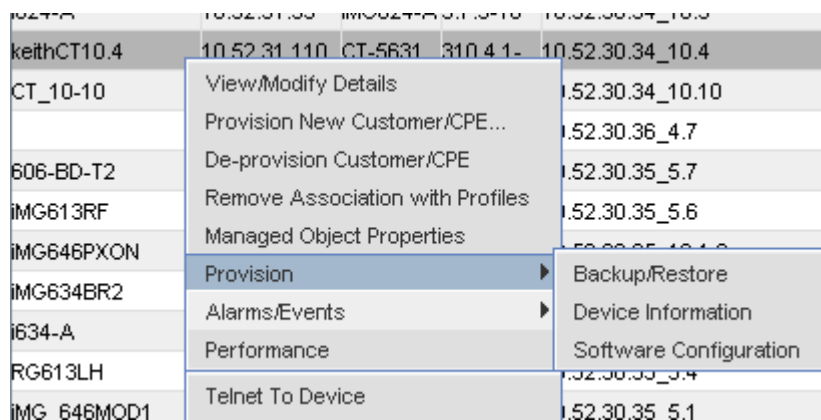

FIGURE 5-223 Menu Items Available for Comtrend (Provision added in SP5)

5.7.6.3 Feature Limitations

Although provisioning the Comtrend uses the same GUI panels as other CPE devices, there are limitations because certain features supported on the NMS are not supported on the Comtrend CPE, and this affects the provisioning process and tools that are used, detailed in 5.7.6.4.

- The upstream port cannot be determined, and so provisioning is done using the CPE MAC address. This is similar to provisioning an iMG without an iMAP. Refer to 7.11.
- An Auto-Configuration Server (ACS) URL must be configured in the CPE for using TR-069 for communicating with the ACS (the NMS). The current release of the Comtrend CPE is not able to use DHCP to configure the ACS URL, and so for SP5 the **Comtrend Boot Configurator** must be used. Refer to 5.7.6.5.
- Customer ID (SysContact on CPE) is limited to 15 characters. If more than 15 characters are used when provisioning a triple play customer, the iMAP ADSL bond port will use the entire string, but the Comtrend CPE SysContact will be truncated to 15 characters, resulting in more complex customer management.
- Derived voice service is not supported unless the VoIP phone is connected directly an Ethernet port and the CPE can provide a bridged Ethernet connection. When provisioned this way, the VoIP features will not be managed by NMS.
- The only supported internet service is Bridged.
- For Video, only IGMP snooping enabled is supported on the CPE.
- Only a subset of wireless features can be configured using the NMS.
- The Compare Profile feature is not supported.
- The MDTI feature software configuration is not supported, since the software file uses a different format.
- The NMS must use the configuration file to make most of the changes to the CPE and then sends it back to the CPE using TFTP or CWMP (the default is TFTP). Therefore, when any changes are made (using the Service Management panels), the configuration file is updated and the CPE must reboot for the changes to take effect. During this reboot services are dropped until the CPE returns to service.

5.7.6.4 Provisioning Flow

Taking the feature limitations into account, as listed in 5.7.6.3, provisioning the Comtrend CPE involves the following concepts:

1. Before a Comtrend CPE device is sent to a customer, it will first need to be connected to a PC (the NMS server) to enable the default device configuration. The provider will run the Comtrend Boot Configurator Tool and upload the default boot configuration to the CPE which will add the management VLAN and TR-069 information so that it can be managed using TR-069. It also includes the Inform interval.
2. Existing iMG/RG profiles (General, Internet and Video) can be used, but not all values in these profiles will apply. Non-applicable parameters will be skipped when the profile is deployed or used to provision the CPE.
3. When provisioning the Triple Play form, the CPE MAC address is required because it cannot be correctly determined automatically and mapped with device port when needed.

Note: With the Comtrend provisioned with a specific MAC address, it cannot simply be swapped with another unit when performing provisioning or maintenance and having the NMS automatically provision the new unit. The old unit would need to be deprovisioned, then the provisioning process would need to start again.

4. The Comtrend CPE only allows one CLI login session at a time (for example, if CLI is used to initiate TFTP to the device). Therefore, login to the CPE device will fail if another user is already logged in.

Caution: While an administrator is logged into the CPE, the NMS cannot login, and so some features will not work.

5.7.6.5 Comtrend Boot Configurator

The Comtrend Boot Configurator is a tool that allows updating the Comtrend CPEs to use management configuration parameters and is similar to the boot configurator used for iMG/RGs. (Refer to 7.2.5). The main difference is that since Comtrend CPEs do not support getting the TFTP server address through DHCP, you must use the tool to generate the default configuration and then upload it to the device. The following figure shows a sample Comtrend Boot Configurator panel with values filled in.

FIGURE 5-224 Comtrend Boot Configurator

The fields in this form are as follows:

- **Mgmt. VLAN** - The VLAN used for sending and receiving configuration information and downloads to the CPE.
- **Trap Host** - The IP address of the Auto Configuration Server (ACS) - the NMS.
- **ACS URL** - An ACS URL is required to be configured in CPE for using TR-069 for communication with the ACS server (NMS). The ACS URL pointing to NMS server should be:

`http://<NMS IP address>:9797/cwmp/ACS/`

Note: The port number has changed; in SP3 this was 9090.

- **Inform Interval** - How often (in seconds) the CPE contacts the ACS with identification information. The default is 300 (five minutes).
- **ACS User and Password** - The User ID and password to access the ACS server. The CPE uses this to communicate with the ACS.
- **CPE User and Password** - User ID and password to access the CPE. The NMS uses this to communicate with the CPE.
- **Config File Name** - The name of the configuration file on the TFTP server that includes the values selected here.
- **Save Only** - If checked, the settings for the configuration file are saved but are not uploaded to the CPE (there is no physical connection between the ACS and CPE).

5.7.6.6 Staging - Summary

As explained in 5.7.6.4, there is a staging procedure needed for the Comtrend devices so that they may be provisioned. Staging can be accomplished using one of the following two methods summarized below:

- Method 1

Run the Comtrend Boot Configurator at the NMS server. Check the Save Only checkbox before clicking OK. Then copy the configuration file to a PC connected to a LAN port on the Comtrend. Use the web GUI on the Comtrend to update settings with the configuration file.

- Method 2

Install and run the NMS server software on a PC connected to a LAN port on the Comtrend. You must run the NMS server software so the TFTP server is running. Run the Comtrend Boot Configurator at this PC. Do not check the Save Only checkbox before clicking OK.

Note: The Comtrend could be connected to the NMS server that is used to manage the network. However, since this would allow access to the network devices, this is not recommended.

5.7.6.7 Staging - Method 1

- Prerequisites

- The Comtrend is set to factory defaults.
- A PC is connected to a LAN port on the Comtrend device. The PC obtains an IP address automatically from the Comtrend.

1. At the NMS server, access the Comtrend Boot Configurator by going to <NMS_Home>/bin and double-clicking on **AT_CTBootConfigurator**.

2. On the Comtrend Boot Configurator Form (Figure 5-204), the only fields that must be filled in are:

- Mgmt. VLAN
- ACS URL

Note: For a description of these and other fields, refer to Figure 5.7.6.5.

3. Check the **Save Only** checkbox. Click on **OK**.

4. Go to <NMS_Home>/tftp/Comtrend and locate the configuration file, for example `ct_backupconfig.conf`. Copy the configuration file to a PC connected to a LAN port of the Comtrend.

5. At the PC connected to the Comtrend, open a web browser and go to `http://192.168.1.1/` to access the Comtrend web GUI. Log in with User Name `root`, and Password `12345`. In the GUI sidebar, select **Management > Settings > Update**. The Tools - Update Settings page opens as shown in Figure 5-225.



FIGURE 5-225 Comtrend Tools - Update Settings

6. In the Settings File Name field, enter or browse to the configuration file copied in step 4. Click **Update Settings**. The Comtrend reboots (Figure 5-226). The Comtrend is now ready to be deployed

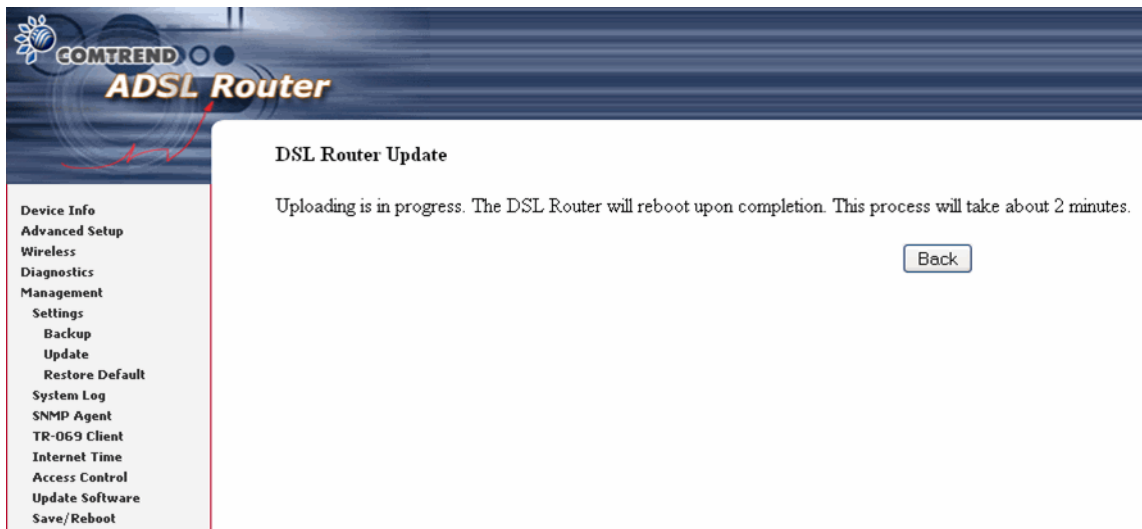

FIGURE 5-226 Updating Comtrend with Configuration File

Note: The following steps are optional.

- After the Comtrend has rebooted, to verify settings, select **Device Info > WAN**. The WAN Info page should show the CPE Mgmt service provisioned with the VLAN specified in step 2. Refer to Figure 5-227.

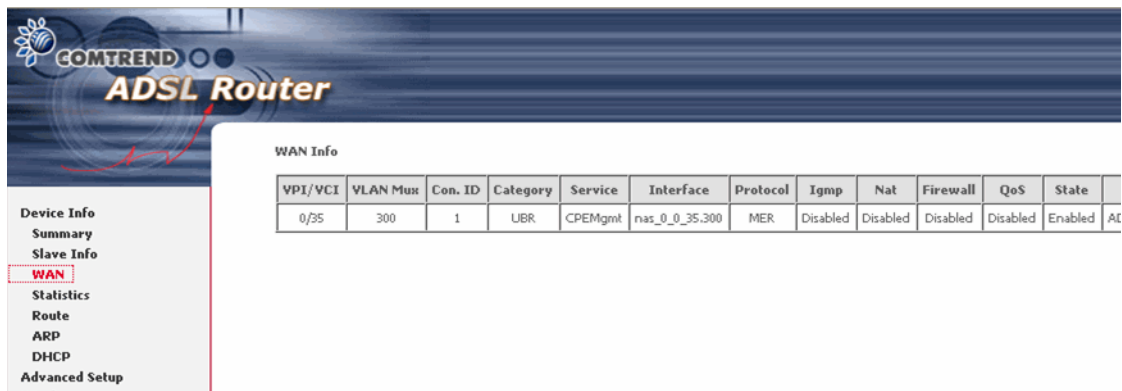

FIGURE 5-227 Comtrend WAN Info

- Select **Management > TR-069 Client**. The TR-069 client - Configuration page should show the ACS URL and other fields set to the values specified in step 2. Refer to Figure 5-228.

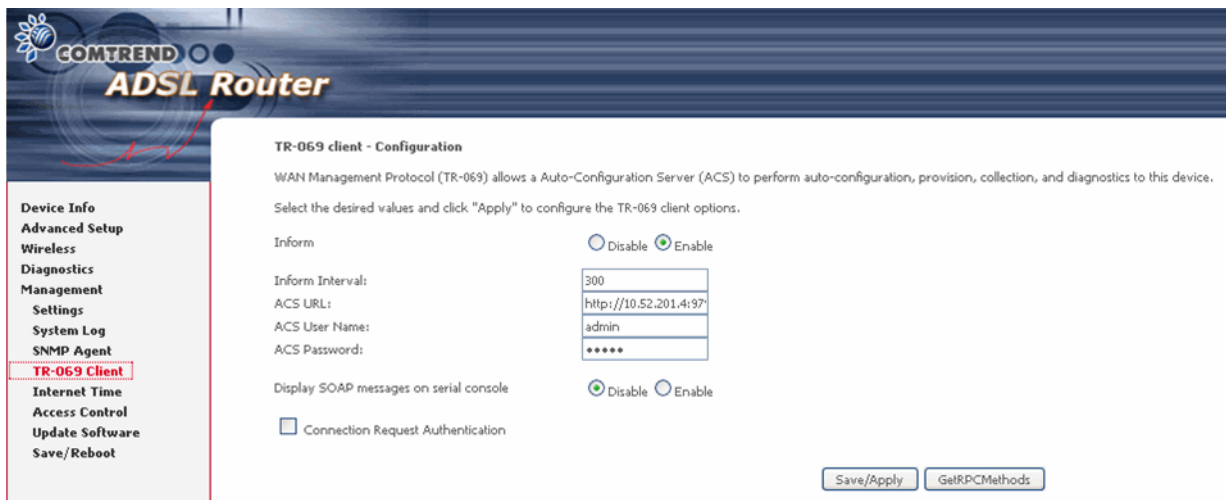

FIGURE 5-228 Comtrend TR-069 client - Configuration

5.7.6.8 Staging - Method 2

- Prerequisites:
 - The Comtrend is set to factory defaults.
 - A local PC (desktop/laptop, etc.) has been loaded with the NMS release 11.0 SP5 software.
 - The local PC is connected to a LAN port on the Comtrend device. The PC obtains an IP address automatically from the Comtrend.

The specific steps are as follows:

1. Start up the local NMS on the local PC (*Programs->AlliedView NMS->Start NMS Server*).
2. Access the Comtrend Boot Configurator by going to <NMS_Home>/bin and double-clicking on **AT_CTBootConfigurator**
3. On the Comtrend Boot Configurator Form (Figure 5-224), the only fields that must be filled in are:
 - Mgmt. VLAN
 - ACS URL: change the IP address to the NMS server used to manage the network

For a description of these and other fields, refer to Figure 5.7.6.5.

4. Uncheck the **Save Only** checkbox. Click on **OK**.
5. The CPE Connection dialog box opens (Figure 5-229). Click OK. (Default Password is 12345.)

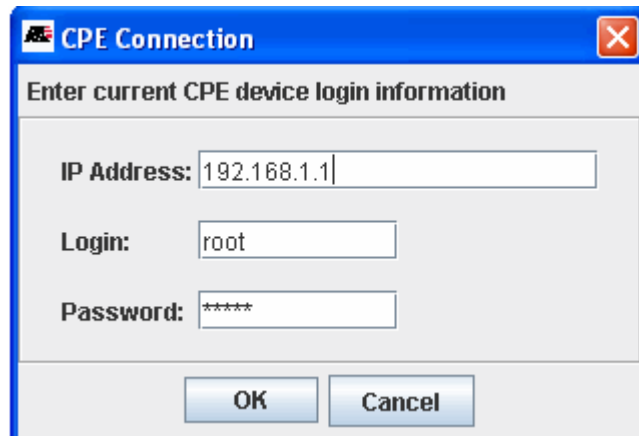

FIGURE 5-229 Comtrend CPE Connection Dialog Box

6. The configuration file is uploaded to the Comtrend device, the device reboots, and the device is now ready to be deployed.

5.7.6.9 Example Procedure - Provisioning

At an NMS client on the network, the Comtrend is provisioned as follows:

1. Bring up the Triple Play form for Bonded ports, as explained in 5.6.3.4. Refer to Figure 5-230.
2. For the Comtrend device, you must enter a Description (Customer ID) of 15 characters or less. If more than 15 characters are used, the iMAP ADSL bond port will use the entire string, but the Comtrend CPE SysContact will be truncated to 15 characters, resulting in more complex customer management.
3. For the Comtrend device, you must fill in the MAC address, found at the bottom of the Comtrend.
4. Do not use the Derived Voice-related fields, since derived voice will not be managed by the NMS (refer to 5.7.6.3). *Note:* You may provision a POTS line.
5. Click on **Provision**. The Comtrend device is added to the iMG/RG table, but the IP address remains 0.0.0.0 until the Comtrend device is physically connected to the network.

FIGURE 5-230 Triple Play Form for Comtrend Device

At the subscriber premises, the subscriber:

1. Plugs in the dual ADSL connection.
2. Powers up the Comtrend.

The Comtrend boots up twice, first using the configuration parameters that were loaded during the staging process, and then the configuration downloaded by the NMS server. (This should take approximately five minutes.)

3. Connects the video and data devices. As the devices connect to the network, they come up and begin passing data.

Back at the NMS, on the iMG/RG table, the columns have provisioning information filled in, except for the upstream port, as shown in Figure 5-231.

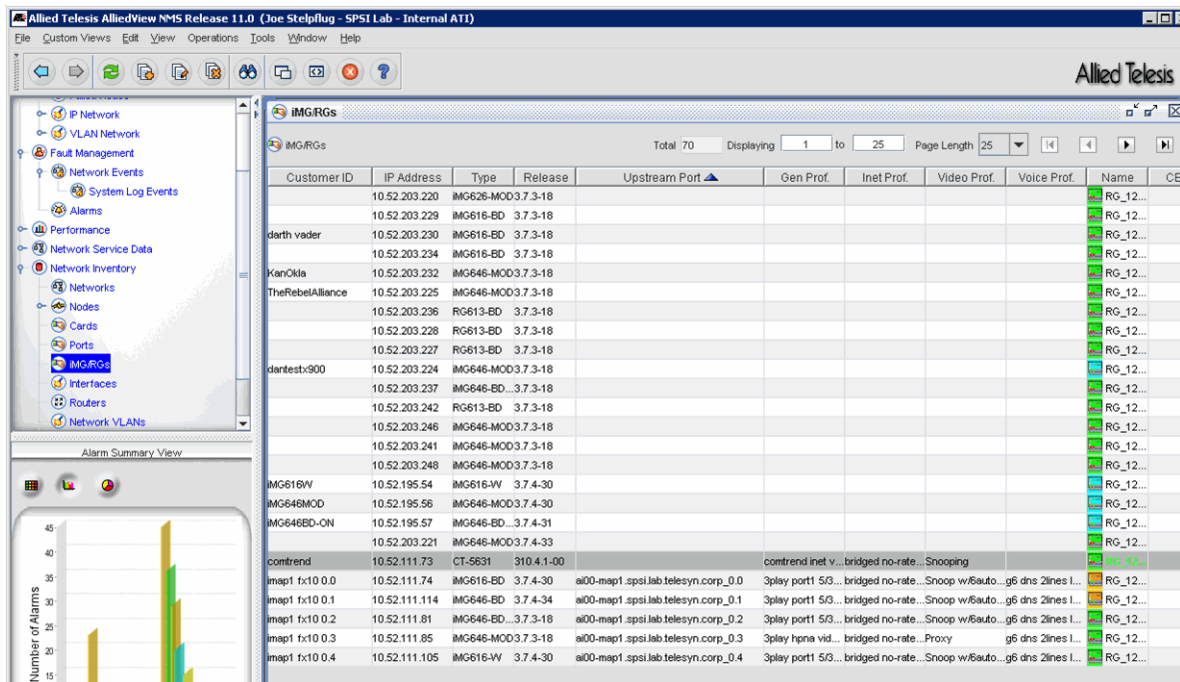

FIGURE 5-231 Comtrend Device in iMG/RGs table

- Go to the Nodes table and find the upstream iMAP device for the Comtrend. Right-click on the node, then click *Discover Attached iMG/RGs*. The Comtrend device now has the upstream port filled in at the iMG/RG table, and provisioning is complete.

5.7.6.10 Managed Object Properties

Right-click on the Comtrend row in the iMG/RG table. Selecting **Managed Object Properties** brings up the set of MO Properties window. The following figures show these.

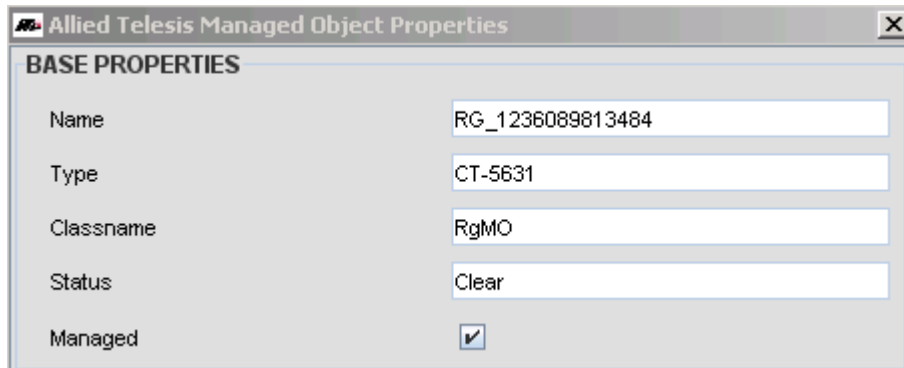

FIGURE 5-232 Comtrend Object Properties - Base

ConnectionRequestURL	http://10.52.31.98:30005/
Profile	
VoipProfileName	
ProductClass	96358BGWE
Version	v2
RgGenProfileMName	
SysLocation	V3 NMS Lab
CesProfileMName	
OUI	001d20
Release	310.2.3-00

FIGURE 5-233 Comtrend Device Parameters (1)

LastBackupName	
ExternalIPAddress	10.52.31.98
SerialNumber	001d2020734a
ChildrenKeys	
InformTime	Fri Dec 31 19:01:43 EST 1999
MacAddr	00:1d:20:20:73:4a
PeerEndpointIDs	
ConfigChanged	
RgCustomerID	Comtrend_1
ProfileMName	
UpstreamDevicePort	
InetProfileMName	
Category	Comtrend

FIGURE 5-234 Comtrend Device Parameters (2)

Several parameters are collected during discovery and by calling operations to retrieve basic device information and these few are required to manage the CPE using (CWMP) TR-069.

- Product Class - Group of devices differentiating device types
- OUI - Unique identifier for differentiating device category
- Connection Request URL - ACS initiated operations must use this URL
- Serial Number - Uniquely identifies the device to the NMS

5.7.6.11 CWMP Browser

Also available in NMS release 11.0 SP5 is a CWMP browser that allows the user to view and change the parameters on a TR-069 compliant device. The tool is accessed by selecting **Tools -> CWMP Browser** (directly above SNMP MIB Browser). The TR-069 Operations Form appears.

In the Device pull-down are available TR-069 devices available for the NMS, which in release 11.0 SP5 are the Comtrend devices.

5.7.7 POE View / Modify Port

The Customer Management form has an additional POE tab that can be used to modify the POE settings for an individual port. Refer to the following figure.

Note: These settings can also be changed using a Profile, which is the preferred method. Refer to 6.10.1.

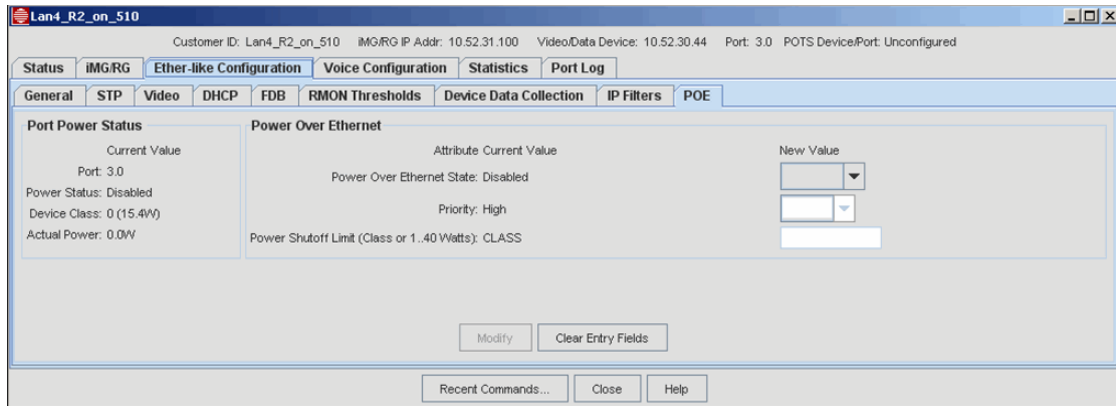

FIGURE 5-235 View / Modify POE Port

5.8 Scheduling and Controlling Provisioning Tasks

5.8.1 One Time

When a task is to be performed one time only, the user will see the One Time Schedule type form that as the options of having the AlliedView NMS perform the task. Refer to the following figure.

FIGURE 5-236 One-time Task Form

The user can select:

- **Now** - The task begins as soon as the AlliedView NMS is able to perform it.
- **Hold** - The task is placed in the Task List table and will never at this point be performed. The user can modify the status of the task at a later time so that it will be performed.
- **Schedule** - The task will be performed at the date and time selected from the pull-downs (if the time selected is before the current time, there is an error message.)

If the user chooses **Now**, the **Task Details Form** immediately appears, which gives the attributes, status, and options for the task chosen. For an example, refer to the following figure.

Device	Sub Task Status	Execution State	Errors	Last Change
172.16.33.13	Stopped	Download Failed	Yes (double click for Details)	2005 Apr 15 03:14:0...

FIGURE 5-237 Task Details Form

In this form, the user can double-click on the specific task and get details of the status of the task. (This is especially useful if the task as failed, as seen in the figure.) The user also has the following options for the specific task(s) that are chosen:

- **Download** - Download the file onto the device. (Software Download only).
- **Apply New Images** - Load the files onto the device so that the device is running with the files (Software Download only).
- **Make Preferred** - For a file, make it the Preferred file for the device (Software Download only).
- **Revert** - Go back to the device state before the task was executed (Software Download only - this includes all tasks necessary to get the device back to the state it was in before the software download).
- **Show Commands** - shows the commands (and error messages) for the device that are used for the task.
- **Abort** - If the task is running, stops the task.

If the task is not currently being performed the user can select **Modify Schedule** to change the time or **Delete Task**.

If the user had chosen **Hold** or **Schedule** for the task, the task is placed in the Task table; the user can select **Tools -> View Tasks** from the main menu and see the task in the View Tasks Form (explained in 5.8.3).

5.8.2 Recurring

When a task can be performed on a recurring basis, the Recurring Schedule form appears, as shown in the following figure.

FIGURE 5-238

The user still has the option of performing the task with the **Now**, **Hold**, or **One Time** option, but can also choose **Recurring** and then select recurring options (time and then the weekly or monthly recurrence). The task is then added to the **View Tasks Form**, explained below.

5.8.3 View Tasks Form

Once a task has been performed or placed in a schedule, it is added to the main task table, the **View Tasks Form**, which allows the user to query or immediately activate a task, as well as to abort a task that is in progress. The Task Table is accessed by selecting **Tools -> View Tasks** from the main menu. The following figure appears.

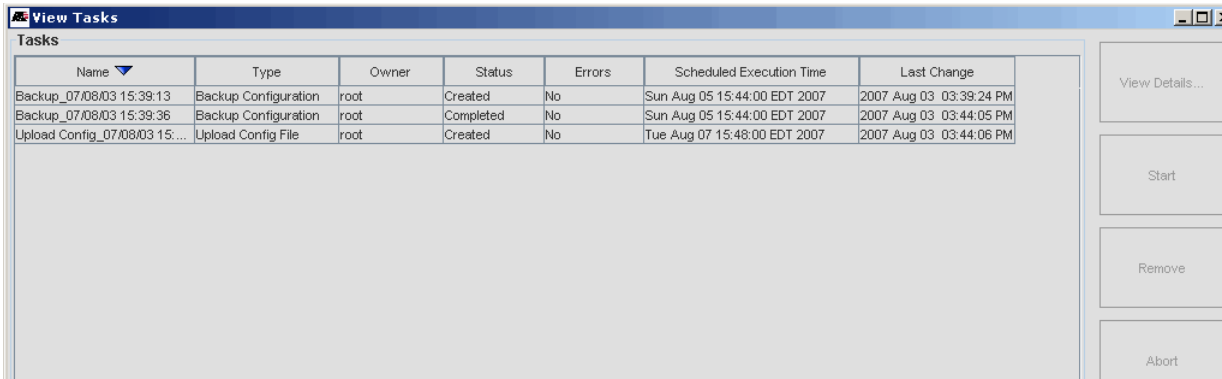

The screenshot shows a window titled "View Tasks" containing a table with the following data:

Name	Type	Owner	Status	Errors	Scheduled Execution Time	Last Change
Backup_07/08/03 15:39:13	Backup Configuration	root	Created	No	Sun Aug 05 15:44:00 EDT 2007	2007 Aug 03 03:39:24 PM
Backup_07/08/03 15:39:36	Backup Configuration	root	Completed	No	Sun Aug 05 15:44:00 EDT 2007	2007 Aug 03 03:44:05 PM
Upload Config_07/08/03 15:...	Upload Config File	root	Created	No	Tue Aug 07 15:48:00 EDT 2007	2007 Aug 03 03:44:06 PM

Below the table, there are three buttons: "View Details...", "Start", and "Remove". Below these buttons is an "Abort" button.

FIGURE 5-239 Task List Table

After selecting a task, the user can click **View Details** to see the **Task Details** form, explained in 5.8.1. (The user can also double-click the task to bring up the Task Details form.) If the task has not been performed yet (or is not yet performed on a schedule), **Start** will begin the task immediately. The **Remove** button deletes the task from the list. If the task is in progress, the **Abort** button will stop the task.

Note: In release 10.0, the user can sort on the field names, as shown in [Figure 5-239](#).

Note: The Task Details form also allows the user to Start or Abort an individual task.

The button **Cleanup** brings up a window that allows the user to select a date in which all tasks prior to that date are selected. The user can then remove them. Refer to the following figure.

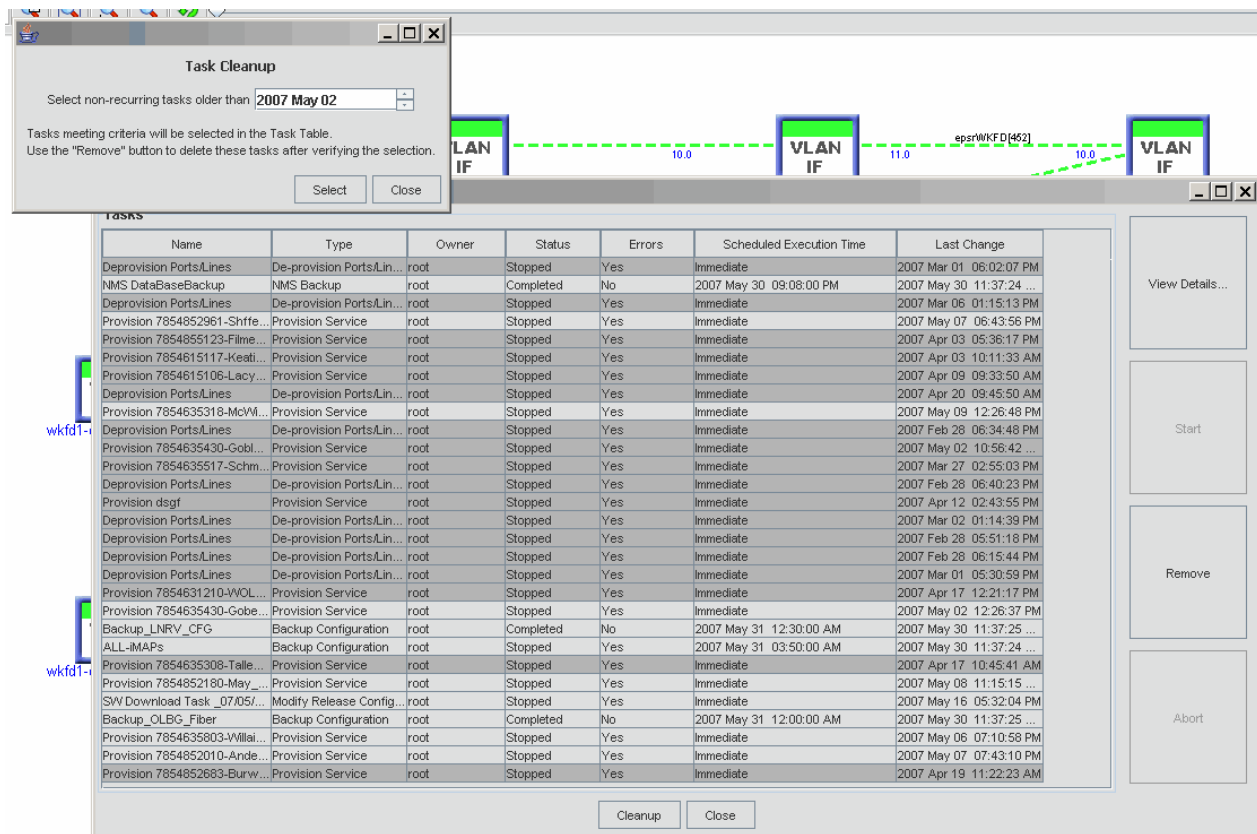

FIGURE 5-240 Cleanup Button for View Tasks Window

The user selects the **Cleanup** button, and then selects a date. After pressing **Select**, the user sees the Task Window select all of the tasks that meet that criteria. The user can then select **Remove**, and all of the tasks prior to that date are removed.

5.9 Other Device Control Tasks

5.9.1 Alarms/Events

Events and alarms indicate significant occurrences or changes on a monitored network that may be of interest to the Network Administrator. Events typically provide details on all significant occurrences on a monitored network. Alarms typically provide an indication of a condition or event that may require immediate attention. Right-clicking the device and choosing the **Alarms/Events** option will bring up the alarm and event views as follows:

- **Alarms** will bring up the Alarm panel with any alarms for the device.
- **Events** will bring up the Events Panel for the device.
- **Summary** will bring up a GUI showing the total and per-severity counts of events and alerts for the device.

5.9.2 Performance

Right-clicking the device and choosing the **Performance** menu option will bring up the Performance View (statistics) for the device.

5.9.3 File Comparison (Text Files)

The Configuration File Comparison feature compares and displays two **text** files side-by-side with their differences highlighted. Text files can be selected for comparison from the Configuration File Management, Command Script Management, and Device Backup/Restore applications. Any two text files from any two devices can be compared.

Note: This feature can only compare files that are created or part of Configuration File Management and Device Backup/Restore applications. Also, this feature does not compare binary files, so backup/restore files for iMAP devices cannot be compared. Configuration files, however, are in text format and can be compared. Finally, backup files are read-only, since they may be needed to reconfigure a device to a previous configuration.

This feature is most useful when comparing recurring backups, since changes between backups from the same device will be highlighted. Note that the comparison is between backup files, not the current configuration; to get a comparison between backup files and the current configuration, the user must back up the current configuration.

During backups, the latest configuration is automatically compared to the previous backup and if any changes are detected, the device's ConfigChanged property will be set to the time/date that the change was detected. Note that the change may have occurred at any time between the two backups.

The following table lists the scenarios where the File Comparison feature is used and the main steps that are performed. Following this is an overview of the feature screens and examples.

TABLE 5-59 Scenarios for Text File Comparison

Task	Application	Steps
View Latest Changes	MAP device	<ol style="list-style-type: none"> 1. User navigates to a map. 2. User right-clicks on a single supported device. 3. User selects View Config Changes from the menu. 4. The latest differing backup files for the device are displayed side-by-side with the differences highlighted. 5. The names, dates, and sizes of the files compared are also displayed.
View Latest Changes	Network Inventory	<ol style="list-style-type: none"> 1. User navigates to the Network Inventory. 2. User right-clicks on a single supported device. 3. User selects View Config Changes from the menu. 4. The latest differing backup files for the device are displayed side-by-side with the differences highlighted. 5. The names, dates, and sizes of the files compared are also displayed.
View Latest Changes	Device Backup/Restore	<ol style="list-style-type: none"> 1. User navigates to Device Backup/Restore. 2. User right-clicks on a single row. 3. User selects the Compare Files button. 4. The latest differing backup files for the device are displayed side-by-side with their differences highlighted. 5. The names, dates, and sizes of the files compared are also displayed.

TABLE 5-59 Scenarios for Text File Comparison

Task	Application	Steps
View Latest Changes	Config File Mgmt	<ol style="list-style-type: none"> 1. User navigates to Config File Mgmt. 2. User right-clicks on a single row. 3. User selects the Compare Files button. 4. The latest differing config files for the device are displayed side-by-side with their differences highlighted. 5. The names, dates, and sizes of the files compared are also displayed.
View Changes	Device Backup/Restore	<ol style="list-style-type: none"> 1. User navigates to Device Backup/Restore. 2. User selects Compare Files button with no rows selected. 3. An empty comparison display pops up with fields for selecting/entering files. 4. User selects 2 files and then the Diff button. The file chooser defaults to the backup directory but also allows selecting files from the user's CCM directory. 5. The selected files are displayed side-by-side with their differences highlighted. 6. The names, dates, and sizes of the files are also displayed.
View Changes	Config File Mgmt	<ol style="list-style-type: none"> 1. User navigates to Config File Mgmt. 2. User selects Compare Files button with no rows selected. 3. An empty comparison display pops up with fields for selecting/entering files. 4. User selects 2 files and then the Diff button. The file chooser defaults to the user's CCM directory but also allows selecting files from the backup directory. 5. The selected files are displayed side-by-side with their differences highlighted. 6. The names, dates, and sizes of the files are also displayed.
View Changes	Command Script Mgmt	<ol style="list-style-type: none"> 1. User navigates to Command Script Mgmt. 2. User selects Compare Files button with or without rows selected. 3. An empty comparison display pops up with fields for selecting/entering files. 4. User selects 2 files and then the Diff button. The file chooser defaults to the user's CCM directory but also allows selecting files from the backup directory. 5. The selected files are displayed side-by-side with their differences highlighted. 6. The names, dates, and sizes of the files are also displayed

5.9.3.1 Viewing Latest Config File Changes from MAP Device

Following is an example of the first scenario to show the screens and responses for viewing the latest changes.

For configuration comparison on a device, right click on the device and select View Config Changes. Refer to the following figure.

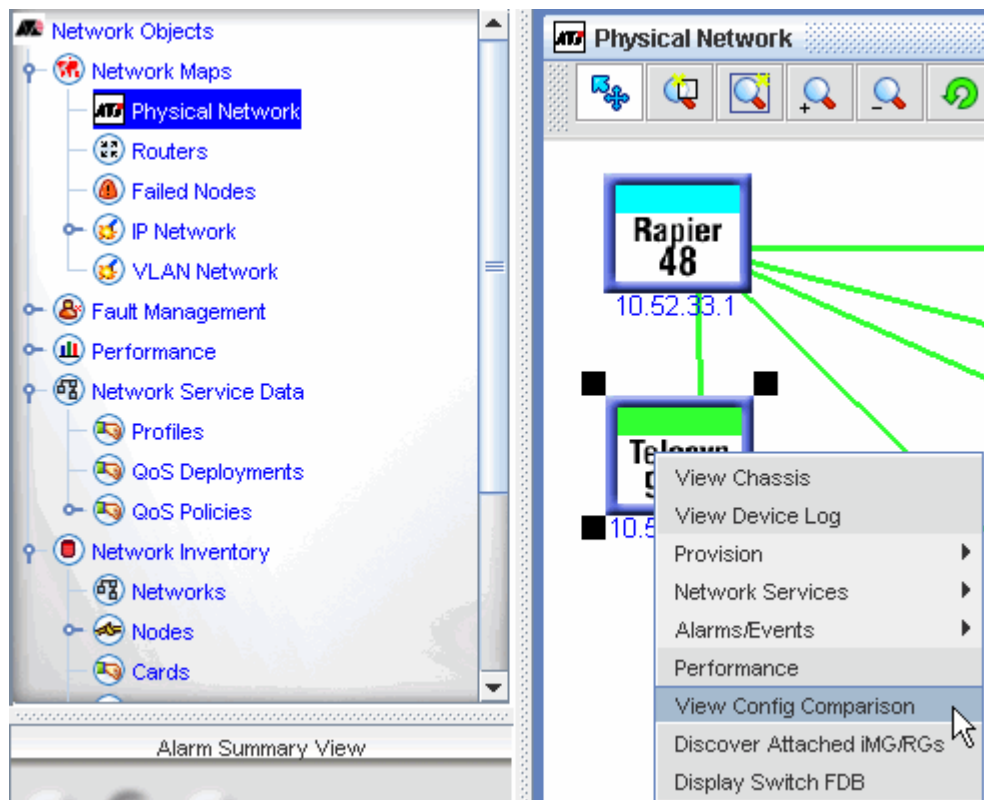

FIGURE 5-241 Selecting a Device for File Comparison

This will display the latest two text backup files from the selected device, side-by-side, with their differences highlighted. See the following figure.

Differences are indicated by highlighting text. Plain text shows lines that are the same in both files. Red text shows lines on the left which are not on the right while blue shows lines on the right which are not on the left. Missing lines are padded with blanks. If a line is simply modified, it shows up red on the left and blue on the right. Extra lines on the left are red and corresponding lines on the right are padded with blanks. Extra lines on the right are blue and corresponding lines on the left are padded with blanks.

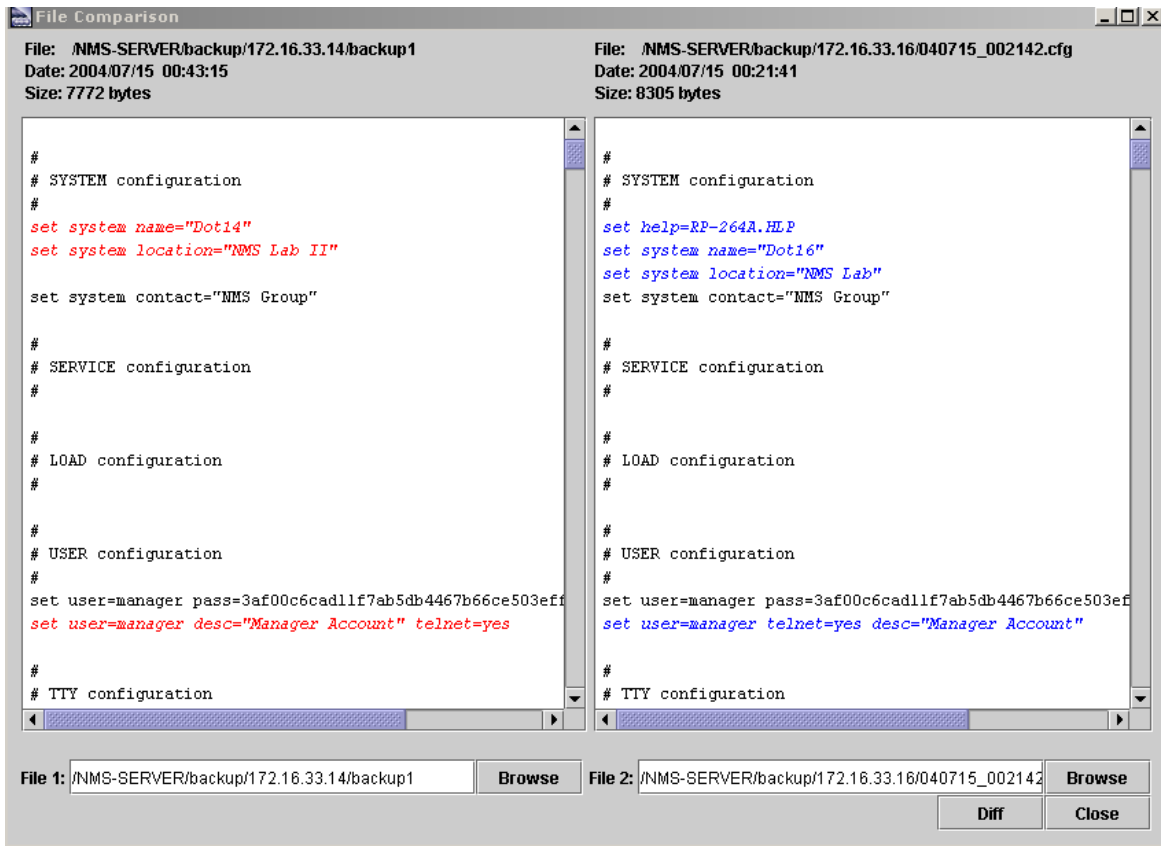

FIGURE 5-242 Comparing Two Backup Files - Highlighting of Differences

If there are multiple backup files that are identical, the **latest two that are different** will be displayed.

Only one file is displayed with the other window blank if:

- All backup files are identical.
- There is only one backup file.

Refer to the following figure.

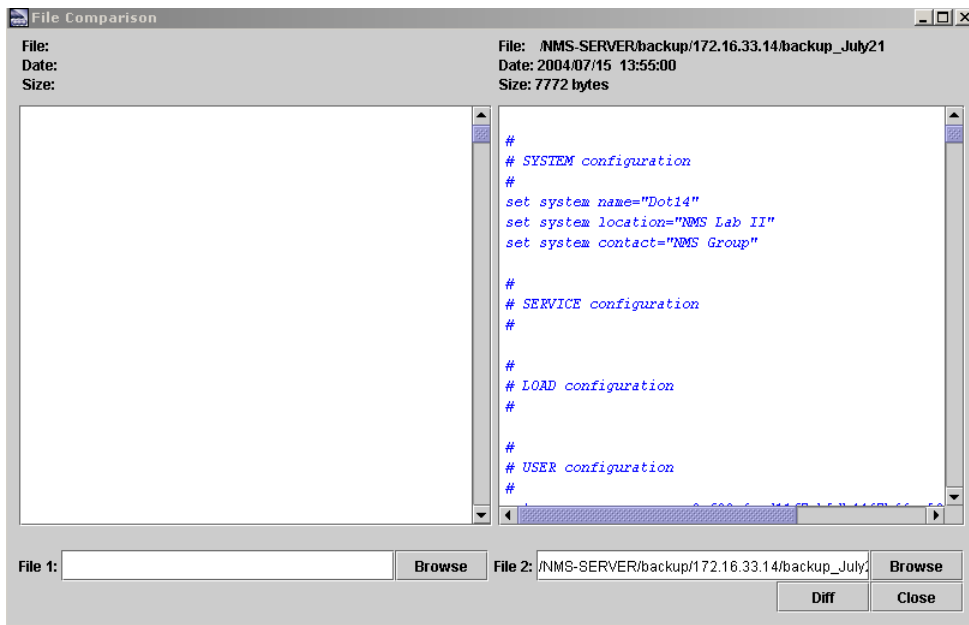

FIGURE 5-243 Only One Backup file - No Comparison Possible

If there are no backup files, and the display will be empty and a notice will pop up indicating no backup files exist for the device. See the following figure.

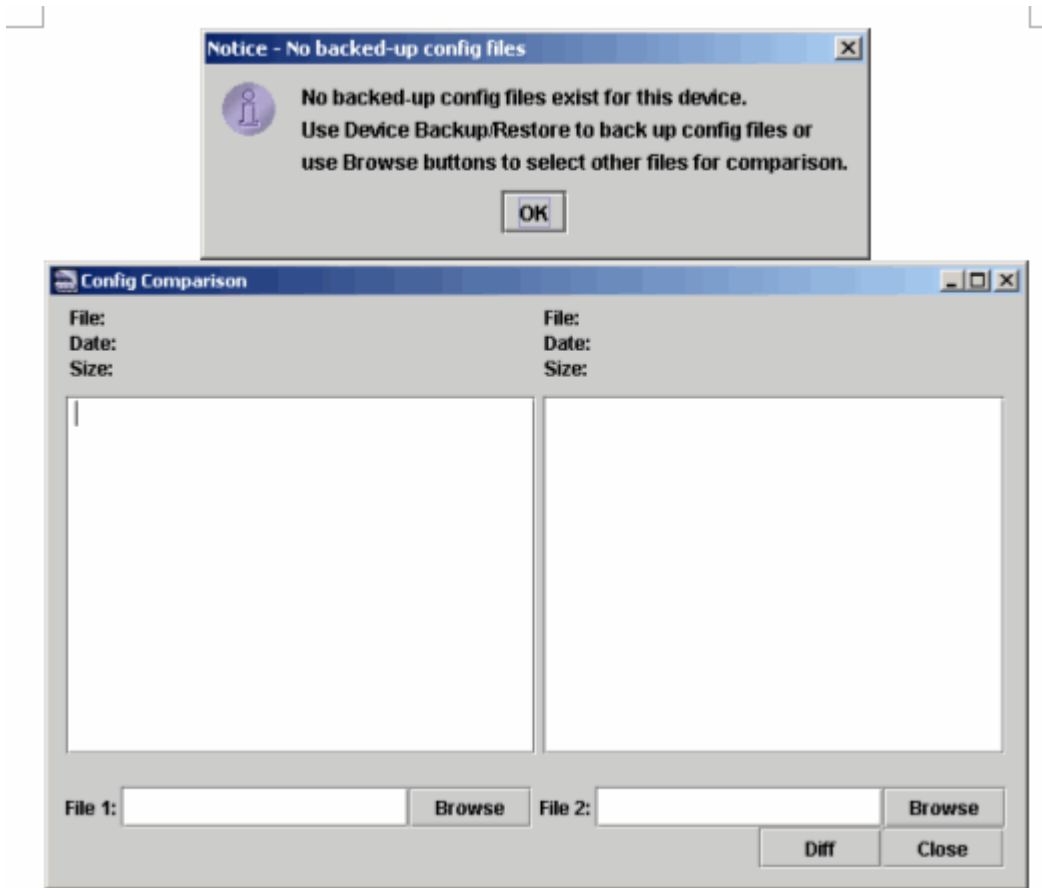

FIGURE 5-244 No Files Available for Comparison

At the top of the display are the file names, their dates, and their sizes. These are updated whenever the files are compared, so they always indicate exactly which files are being compared.

When the user enters other files into the file-selection boxes at the bottom of the display (explained below), they will not take effect until the **Diff** button is pushed. Therefore the bottom file names may not match the displayed data.

Note: If the devices are set to create backups on a schedule, a large number of backup files may be created. The administrator should check the backup/device directories and delete any files that are not needed.

5.9.3.2 Other Applications

The **Compare Files** button on the Device Backup/Restore, Command Script Mgmt, and Config File Mgmt screens can also be used to bring up the differences display. The following figure shows the button

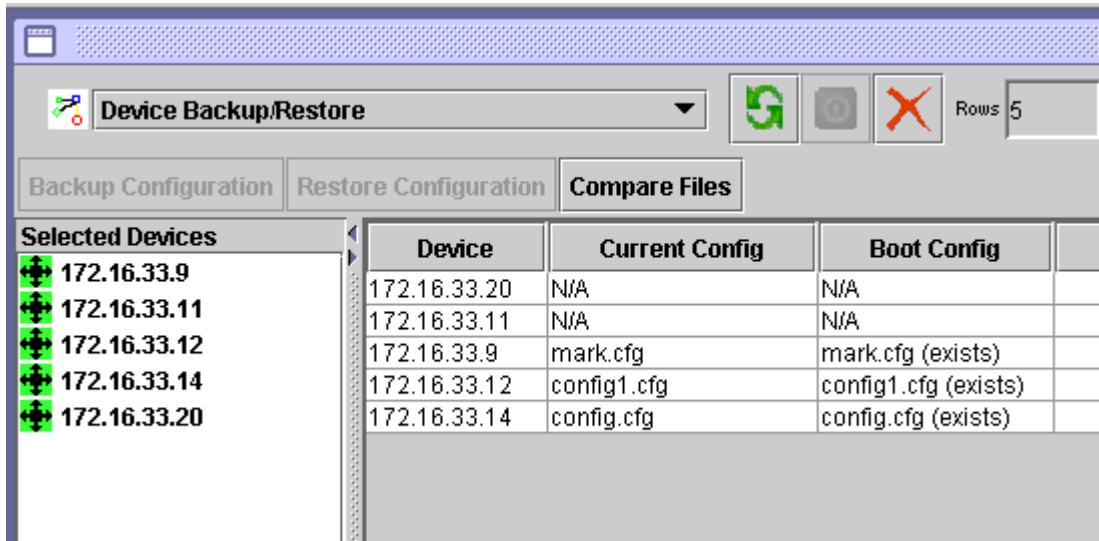

FIGURE 5-245 Compare Files Panel

- If a row is selected from the **Device Backup/Restore** application, the dialog will be pre-filled with the 2 most recent different backup files, if any-as if the device were selected from a map or the network inventory. Note that the backup files are read-only, since these must not be edited in case they are needed.
- If a row is selected from the **Config File Mgmt** screen, the dialog will be pre-filled with the 2 most recent config files from the user's CCM directory, if any.
- For the **Command Script Mgmt** screen, the dialog box comes up empty. Whether the dialog is pre-filled or not, other files can be selected for comparison after the dialog is up. Any number of dialogs can be up at the same time.

Note: For these scenarios, the dialog title is File Comparison rather than Config Comparison.

5.9.3.3 Error Messages

Some miscellaneous error messages and notices include the following:

- Files are identical - When two files compared are actually identical, they are both displayed side-by-side in regular fonts. This notice pops up, too since it may not be immediately obvious that they are identical.

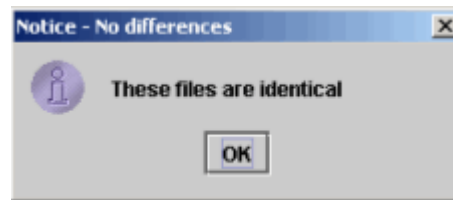

- No files found in user's subdirectory - When brought up from Config File Management, config files are searched for in the user's config file subdirectory instead of the backup directory. This message is displayed if no files are found for the device in the user's subdirectory.

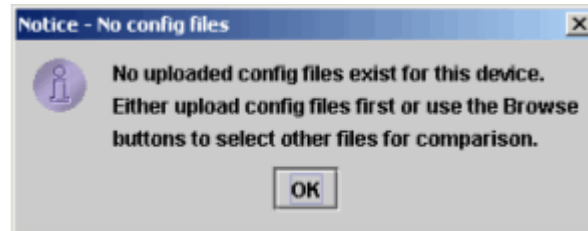

- File not found

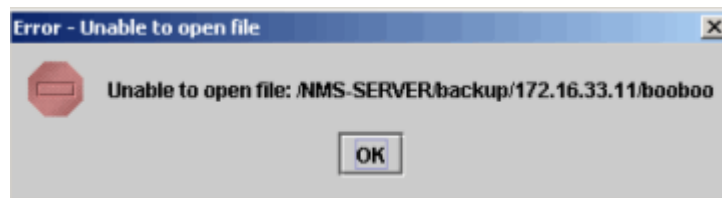

- Rejection of binary file - This application has made a best effort to recognize and then reject binary files which are not valid for text file comparison.

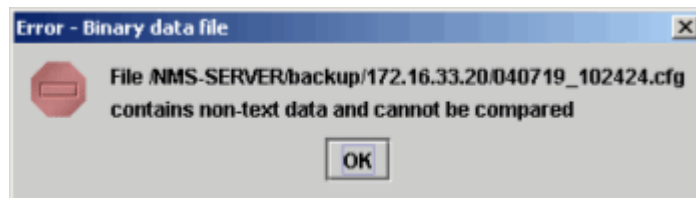

- Device Backup/Restore stores iMAP configurations as binary databases - These files are not valid for text file comparison. Config File Mgmt, however, can upload text config files for iMAP devices starting at release 3.0 and these files are available for text file comparison, however Config File Mgmt does not provide recurrent backups, so each file has to be uploaded on demand.

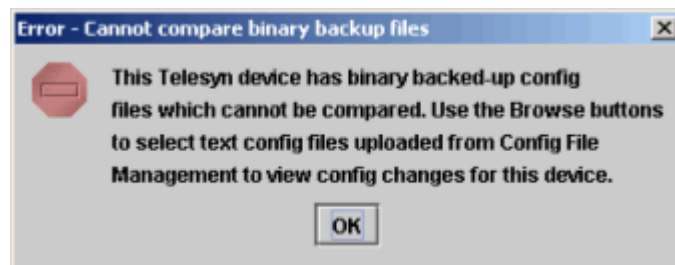

5.9.4 Discover Attached iMG/RGs

For a detailed explanation of how DHCP is set up so that iMG/RGs can be discovered and configured, refer to Section 7. On initial discovery of the iMG/RG (out of the box or provisioned to a different Access Island), the bootstrap VLAN is used. Subsequent discoveries are performed using the RGMgmt VLAN.

This option will (re)discover **all** the iMGs/RGs attached to the iMAP device that use the RGMgmt VLAN. Refer to the following figure.

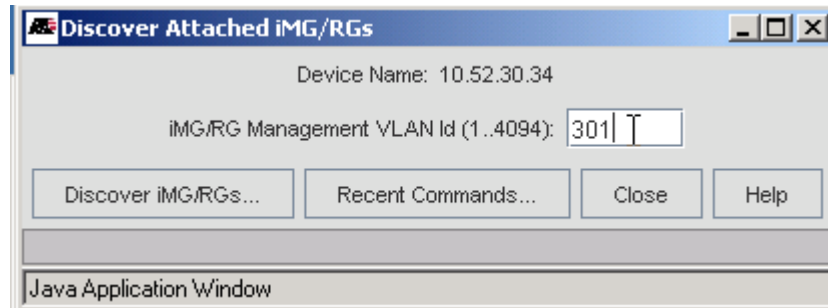

FIGURE 5-246 Discover iMG/RGs for a Device over RGMgmt VLAN

Using this option allows the administrator to perform the discovery immediately and not have to wait for the 24-hour Discovery interval. Any changes made to the iMG/RG, such as profile changes, will be made and reflected in the iMG/RG node in the Network Inventory view as well as the **Triple Play Service Management** Form.

Note: The user can also right click on an individual iMG/RG and perform a rediscovery using the RGMgmt VLAN.

Note: For iMGs attached to AlliedWare Plus devices, iMGs will be discovered as long their management IPs haven't aged out of the router's ARP table. In the rare case where the ARP table has not been refreshed, you can use **Add Network** to rediscover all of the iMGs, or **Add Node** to discover by specific IP(s).

5.9.5 Display Switch Forwarding Database (iMAP Systems)

To view the switch forwarding entries for iMAP devices there is the option Display Switch FDB, accessed by:

- Right clicking on an iMAP physical icon or a node in the inventory table
- Selecting an iMAP physical icon or a node in the inventory table and then accessing the Operations pull-down menu

The Switch Forwarding Database window appears, and includes the Port, VLAN ID, MAC Address, and Status.

Note: This is the same output as the `SHOW SWITCH FDB` command from the device's CLI.

5.9.6 Telnet / SSH to a Device

To access a device using telnet or SSH, there are the following options.

5.9.6.1 Access a Telnet or SSH-enabled Device

Use *Tools -> Open Telnet* or *Tools-> Open SSH* to connect to any device that is telnet- or SSH-enabled and is accessible.

Refer to the following figure that is used for SSH-enabled devices.

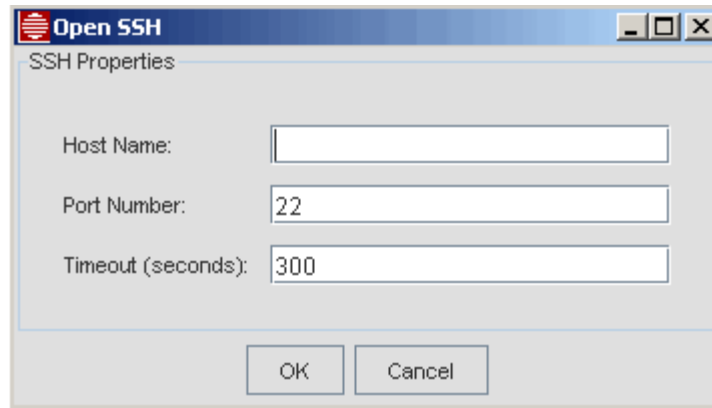

FIGURE 5-247 Accessing a Device for SSH

Note: For SSH, the user-specified Time-out is ignored. If the connection fails to establish, manually close the window.

Note: For Telnet, changing the Timeout value when accessing a device sets the value for other devices as well, so if you right click on the device and select 'Telnet to Device' it will have the timeout value that you set.

5.9.6.2 Access a Discovered Device

Right-clicking the device and choosing the *Telnet To Device* option brings up a command line window with a login prompt for a telnet session, allowing you to send commands directly to the device.

Right-clicking the device and choosing the *SSH To Device* option brings up a panel to fill in the User name and Password. If the device supports SSH and has been configured for SSH, the correct user name and password will access to the device.

Note: The SSH session for iMG/iBG's only accepts one user at a time. So if an active connection is established by the NMS, the "SSH to Device" and "Open SSH" function won't work for these device families.

5.9.7 Browse Device (Rapier Device Only)

To access the Web-enabled on-device management GUI, right-click the device and choose *Browse Device*.

The Browse Device feature is not currently supported for iMAP devices. If an iMAP device is chosen, the following example window appears.



5.9.8 Rediscovery Device (When Required)

This option picks up any changes made to the selected device. This action is most commonly done in the following scenarios:

- The user has updated the user/password in the Managed Objects properties form and wishes to activate the changes.
- A login to a device fails, an alarm is generated, and the user updates the login-password in the manager properties form. The user then clicks on **Rediscover Device** to retry the device discovery with the newly entered userid/password. If the discovery succeeds the alarm is cleared.
- Cards on the device have been re configured. A manual rediscovery is necessary to ensure alarms/conditions are correctly reported (i.e. correct card or port).

Note: If the user does not do a manual rediscovery, the 24-hour rediscovery will be performed and will pick up the changes.

Caution: When changes to a device configuration are made directly on the device (using the CLI) rather than using the NMS, the NMS data will be out of sync with the device, and must be put back in sync by either the 24-hour audit or manual rediscovery.

Caution: The name for a device should not include an '&' or Rediscovery will fail.

5.9.9 Managed Object Properties

To view the Object Properties of a either a Rapier or iMAP device, right click on the device and select *Managed Object Properties*. The Managed Object Properties Form appears.

5.9.10 Manage/Unmanage

To toggle between having the AlliedView NMS monitor the device choose *UnManage* (or if the device is not being managed, *Manage*). This will repoll the device and updated all related information.

5.9.11 Update Status

To poll the device and update the status of the managed object, select *Operations -> Update Status*. Device status is normally polled automatically by the NMS at the poll interval set in each device's Managed Object Properties. The Update Status operation lets the user initiate a status poll outside the normal interval. Status is determined according to the Tester property of each device's Managed Object Properties. Valid values for Tester are:

- Ping - The device is polled merely by pinging it with ICMP.
- Snmping - A more detailed poll is made using snmp.

- Max - The device's status is rolled-up from the current status of all its components in the database, however they were determined (which themselves may have been ping, snmpping, or max), without actually going to the device. Thus with max, a router's status would be the maximum status of all its interfaces.

5.10 Manage CLI Users

Note: This option is available only to users in the Admin group.

This option is used to specify common CLI login-passwords for a set of devices. This data is then used during the discovery process to log in on each device and save the username/password pair on a per-device basis.

Note: This function is part of the Discovery Panel.

5.11 Customer Cutover

5.11.1 Overview

This feature supports reassigning customers, each, from one port to another of the same interface type. Uses for this feature include:

- Port failure
- Network reorganization
- Card upgrades

This feature is especially useful during ADSL and SHDSL card upgrades, where all the customers from one card can be migrated to an upgraded card, such as going from an ADSL16 to an ADSL24 or 48.

Using the Port Management GUI, the user specifies a source port (or ports) on the source card and a destination port or port(s) on the destination card. Once the source and destination port mix is determined the feature converts or cuts over these one or more ports, ensuring that every parameter of the source port is set exactly the same on the destination port. The NMS database and all related components will reflect the new changes. Because of this, cutover is essentially an automated de-provisioning and re-provisioning process of ports with transferable parameter settings, i.e., where the only changes are the iMAP device, slot, and port ids of the customer and all the other port parameter settings remain the same.

While this feature would usually involve moving a set of ports to an upgraded card type, there can be scenarios where the user may choose to migrate one customer on one (i.e. bad) port to another port on the same card, or to a port on another card in the same shelf, or to a port on a another card in another shelf.

Note: To use this feature successfully, the user must be sure to understand what cutover scenarios are supported. This is discussed below.

5.11.2 Cutover Scenarios/Restrictions

This is an **interactive** feature, where the likely scenario involves a technician performing hardware changes (such as metallic cutover) while the NMS user prepares the configuration changes. Once the hardware change is complete, the NMS user invokes this feature to perform and test the configuration changes. Once testing completes, the NMS user can de-provision the previous customer configurations and the technician can remove any hardware no longer needed.

Following are the general restrictions:

- Only provisioned ports can be selected for cutover.
- Using this feature involves interaction, and so cannot be scheduled or executed from a task.
- Cutover does not apply to interface types with non-transferable and/or context-sensitive parameter settings. Such interface types are:
 - CES ports, which depend on card IP configuration and PSPAN configuration
 - NTE ports, which depend on PPP and DS1/DS0 configuration.
 - POTS ports

- Cutover only applies to ports of the same interface type, such as ADSL to ADSL, since otherwise source port parameter settings would not map to destination port parameter settings.
- To ensure parameter compatibility, cutover is restricted to destination ports on devices running the same or higher version of software as the source device, and for ADSL and VDSL, the same annex (A, B, or C).
- When the new ports are provisioned, they are initially provisioned with the port profile. This ensures the creation of creating classifiers as well as parameters that may not be present on the source card since interface parameter changes may have been introduced by an upgraded card.
- It is assumed the VLAN configuration is unchanged, so the cutover must occur within the same Access Island. (Refer to Section 7 on Access Islands and their VLAN configuration.)

Refer to the following table for a list of card types and whether they are supported.

TABLE 5-60 Provisioning Guidelines/Restrictions for the Customer Cutover Feature

Interface Type	Card Type	Notes ^a
ADSL	ADSL8S ADSL16 ADSL16B ADSL16C ADSL24 ADSL24A/B ADSL48A/B ADSL48B ADSL24AE	The annex of destination card type must match source card. <i>Note: The NMS does not validate matching annexes for the non-annexed version of the ADSL24 card.</i>
FE	FE10	Supported
FX	FX10, FX20	Supported
CES	CES8	Not Supported
EPON	EPON2	Not Supported
GE	GE3 GE8 GE24SFP GE2RJ GE24RJ GE4 GE24POE GE40CSFP	Supported, network direction only Supported Supported Supported Not Supported Supported Supported Not Supported
NTE	NTE8	Not Supported
POTS	POTS24A POTS24B	Not Supported Not Supported
SHDSL	SHDSL16 SHDSL24	Supported, but bonded ports have to be moved together to a congruent pair of destination ports.

TABLE 5-60 Provisioning Guidelines/Restrictions for the Customer Cutover Feature

Interface Type	Card Type	Notes ^a
VDSL	VDSL24A	Annex of destination card must match annex of source card
	VDSL24B	Annex of destination card must match annex of source card
XE	XE1	Not Supported
	XE1S	Not Supported
	XE4	Not Supported
	XE6	Not Supported
	XE6SFP	Not Supported

a. If text is Supported, assumes both network and customer direction unless noted otherwise.

5.11.3 Procedure Overview

The source ports are selected from Port Management. A **Cut-Over** button is added to the Port Management screen and behaves as follows:

- When multiple rows are selected, **only** the Cut-Over button is enabled
- When one row is selected, the Cut-Over button and other buttons are enabled.
- When no rows are selected, the Cut-Over button is disabled.

When the Cut-Over button is selected, a dialog pop-up guides the user to reassign the selected ports to available non-provisioned ports. The user can select only one destination per procedure, and so **all** destination ports have to be on the same device, which can be any device known to the NMS.

Depending on the scenario, default destination ports can be automatically assigned by the NMS, although these can be changed by the user. Also where possible, the NMS restricts destination ports to ones that are compatible with source ports.

Once the selections are made, the user selects the Provision button to activate the first step of cutover. The new ports will be disabled (administratively down) while provisioning and then enabled, so the technician can verify that the port is up immediately after the cutover. Port Management can then be used to test the new ports. Once the user is satisfied with the cutover results, another button provides a shortcut to de-provision the old ports. If the dialog is dismissed before the old ports are de-provisioned, they can be de-provisioned any time later from Port Management.

5.11.4 Procedure Example - Transfer to different cardtype

In this example, the user wishes to transfer the 24 ports of an ADSL24 card to an ADSL48A card. (This example would be fairly typical, since many system upgrades involve installing ADSL48A cards and transferring over existing ports.)

5.11.4.1 Copy the Port Attributes from the Original Ports to the new Ports

Figure 5-248 shows the initial configuration, using the card and port management forms for the source and target iMAPs. The 60.80 iMAP is the source device and the 30.34 iMAP is the target device.

Port Management - Device Name: 10.52.68.80				Port Management - Device Name: 10.52.30.34			
Port	Type	Customer ID	Status	Port	Type	Customer ID	Status
6.0	ADSL	sdrADSL0a	Down	6.0	ADSL		Down
6.1	ADSL	sdrADSL1a	Down	6.1	ADSL		Down
6.2	ADSL	sdrADSL2a	Down	6.2	ADSL		Down
6.3	ADSL	sdrADSL3a	Down	6.3	ADSL		Down
6.4	ADSL	sdrADSL4a	Down	6.4	ADSL		Down
6.5	ADSL	sdrADSL5a	Down	6.5	ADSL		Down
6.6	ADSL	sdrADSL6a	Down	6.6	ADSL		Down
6.7	ADSL	sdrADSL7a	Down	6.7	ADSL		Down
6.8	ADSL	sdrADSL8a	Down	6.8	ADSL		Down

Card Management - Device Name: 10.52.68.80					Card Management - Device Name: 10.52.30.34				
Slot	Card Type	Status	Current Load	Preferred Load	Slot	Card Type	Status	Current Load	Preferred Load
0	GE8	UP-UP-Online	9.0.2	-	0	-	-	-	-
1	NTE8	UP-Down-Not Installed	-	-	1	GE3	UP-UP-Online	-	-
2	POTS24	Down-Down-Not Installed	-	-	2,4	CFC24	UP-UP-Online (ACTIVE)	cfc24_9.0.2.tar	cfc24_9.0.2.tar
3	ADSL24A	UP-Down-Not Installed	-	-	3	FC7	UP-UP-Online	-	-
4	VDSL24A	UP-Down-Not Installed	-	-	5	-	-	-	-
5	FX10	UP-UP-Online	9.0.2	-	7	FX10	UP-UP-Online	9.0.2	fe10_9.0.2.tar
6	ADSL24	UP-Down-Not Installed	-	-	8,6	ADSL48A	UP-Down-Not Installed	-	-
7	FE10	UP-Down-Not Installed	-	-	9	ADSL16	UP-Down-Failed	-	-

FIGURE 5-248 Cutover - Initial Configuration

The user selects in the source device the port(s) that are going to be cutover. In most cases these will be the contiguous ports on a card. When the ports are selected, the Cut-Over Customer button is activated, as shown in the following figure.

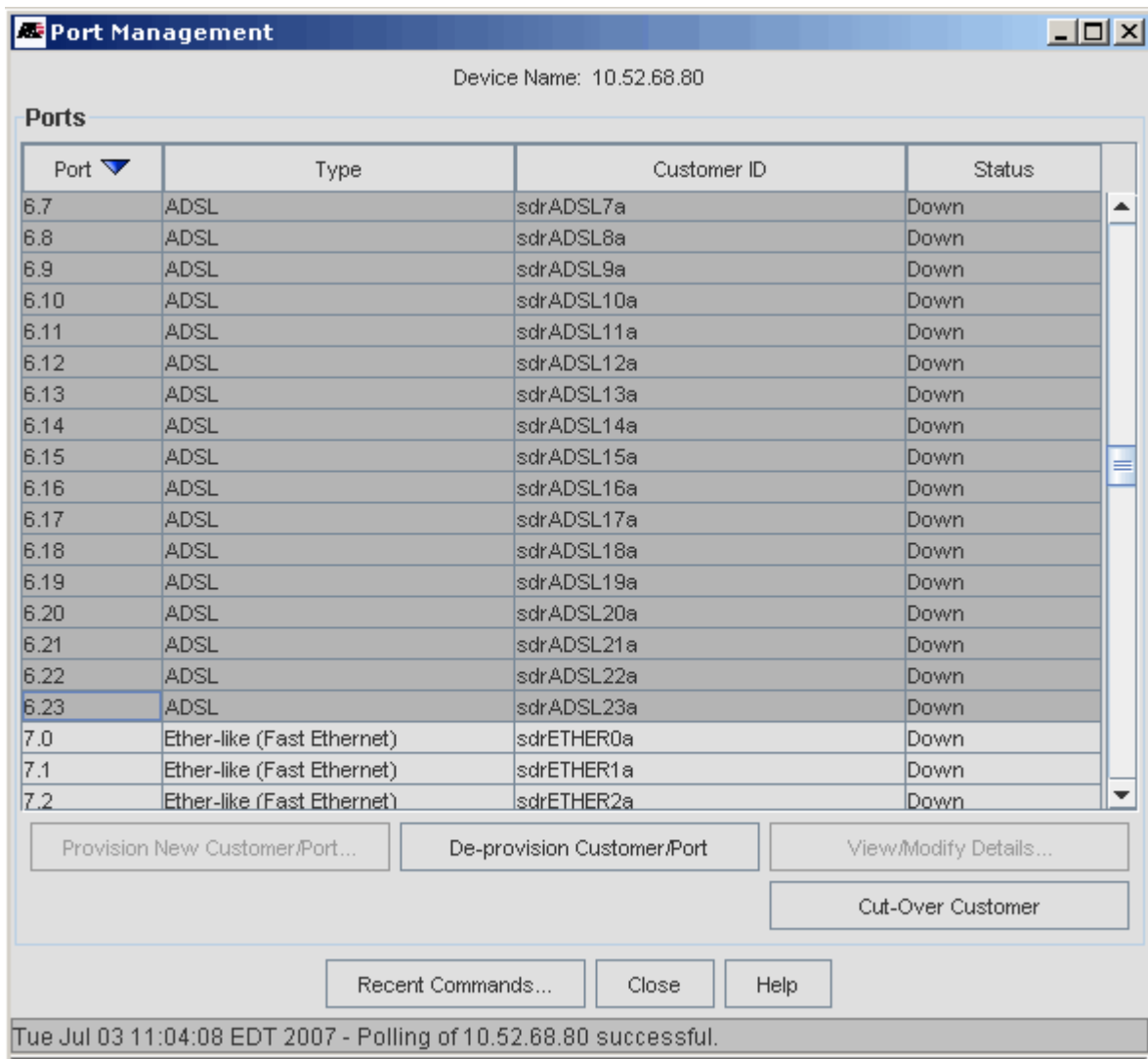

FIGURE 5-249 Selecting Source Ports

The user then selects the now active **Cut-Over Customer** Button, and the Customer CutOver panel appears, as shown in the following figure. Note that the initial destination device is the same as the source device.

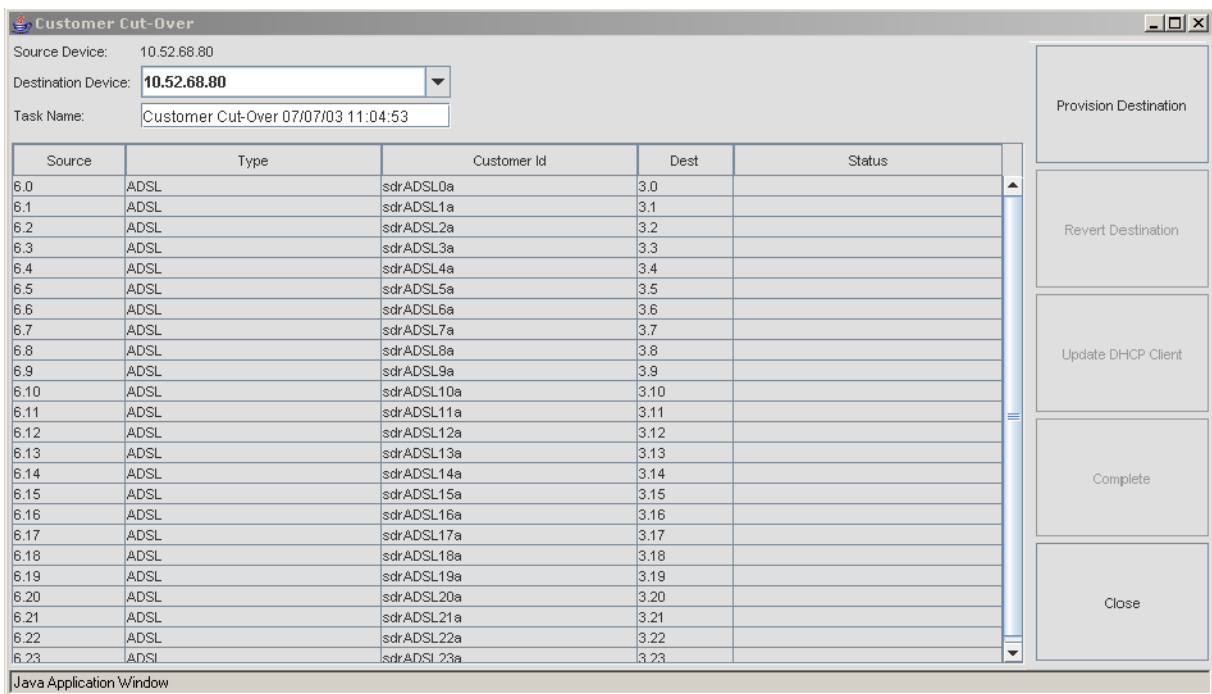

FIGURE 5-250 Initial Customer Cut Over Screen

The user now selects a different device in the Destination Device pull-down. Once selected, the NMS searches the destination device and then lists all the available destination ports, as shown in the following figure.

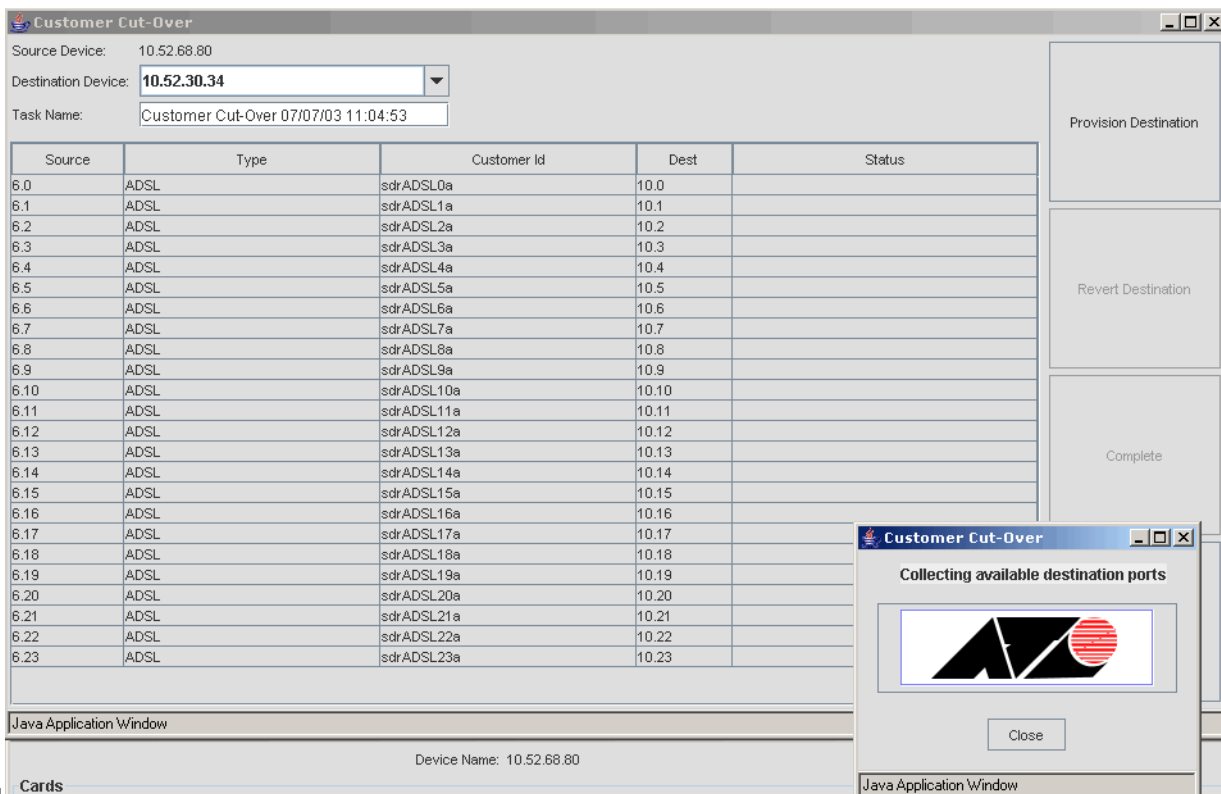

FIGURE 5-251 NMS Finding Available Destination Ports

In most cases, the destination has a one-to-one mapping between ports on the card. However, the user is free to select various destination ports, as shown in the following figure.

Note: Although the destination ports are valid since they are the same type, the NMS will produce an error message if the user tries to transfer an Annexed port to a non-Annexed port.

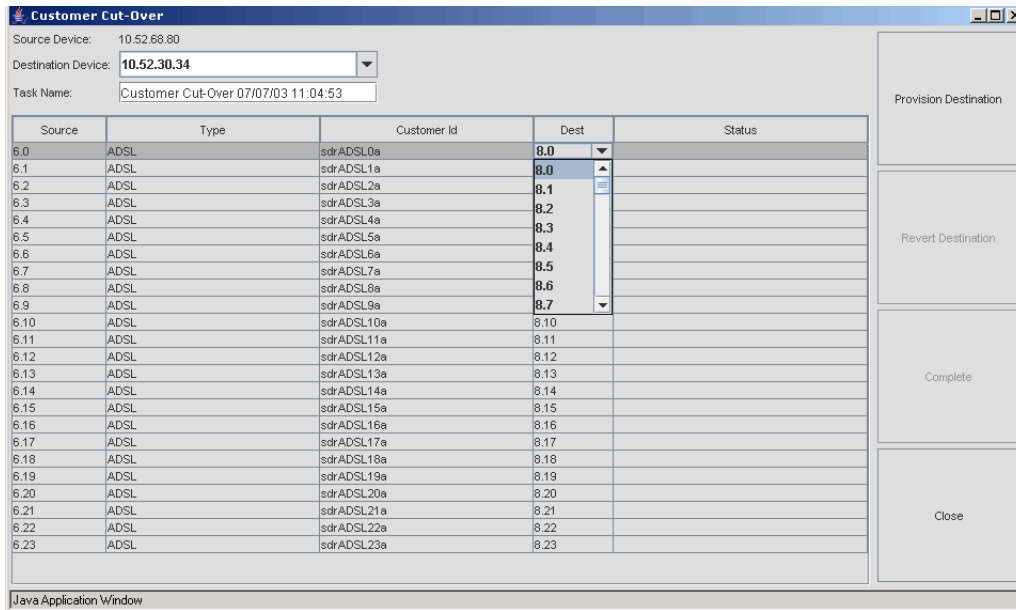

FIGURE 5-252 Ability to Choose any Valid Destination Port

The user then selects the Provision Destination button. The NMS now validates the source and destination ports and displays the status of the transfer as the task completes. Refer to the following figure.

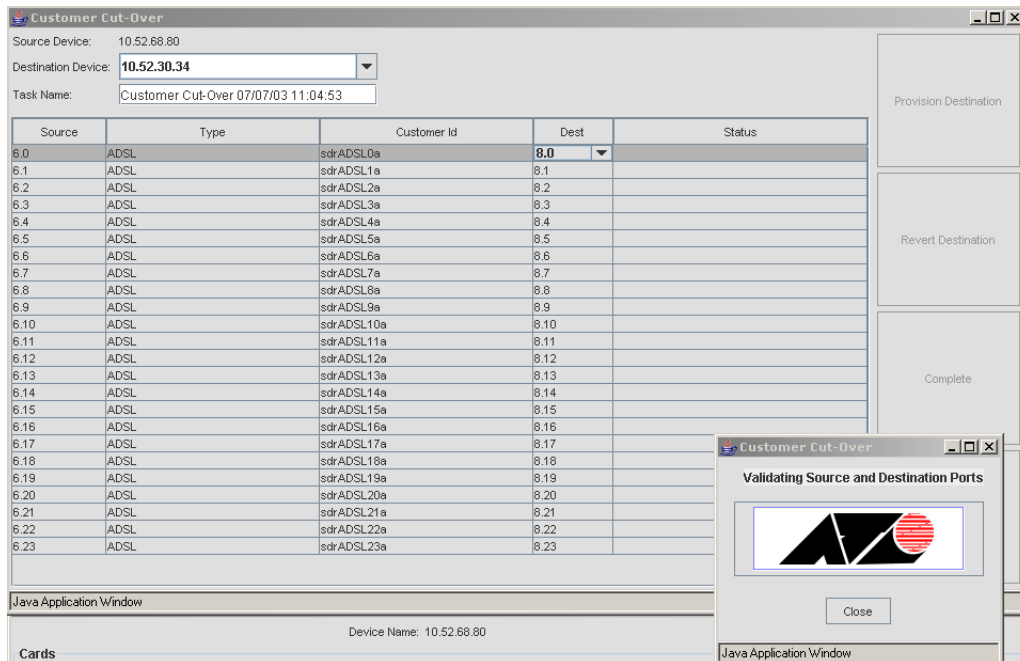

FIGURE 5-253 NMS Provisioning the Destination Ports

5.11.4.2 Physically disconnect/reconnect the ADSL cables

The user now disconnects the ADSL cable(s) and connects them to the ADSL 48 card.

Note: To connect the ADSL cables to another card, the user may need to change the cabling facilities. Also note that the cable type is probably the same, but if the user were going from an ADSL16 card to an ADSL24/48 card, the connections would have to be changed and a different cable type used. Refer to the Component Specification on ADSL cabling types.

The port is now active and is physically connected to the iMG/RG, but the iMG/RG must renew its IP address (if assigned using DHCP) to update DHCP-based filtering on the iMAP port.

5.11.4.3 Force the iMG to perform DHCP Update

In the Task Details panel, select the appropriate iMG/RGs, and then click on the **Update DHCP Client** button. As the iMG/RGs are updated, the Status changes to “DHCP Updated.”

Note: The Update DHCP Client process will fail if the iMG/RG is not powered up and VLAN IP connectivity is lost. Refer to the Note in 5.11.5.1.

5.11.4.4 Copy over the iMG attributes

Returning to the Task Details Form, the user selects the appropriate ports and selects **Complete**. This will update the database with the rest of the iMG/RG attributes, and deprovision the source port.

5.11.4.5 View the Original Ports

Returning to the Port Management Panel, the user can see that the table has the original ports with no customer ID and a status of Down. The user now has the option of re-provisioning the ports for another interface or removing the card (once all ports have been de-provisioned and the card has been destroyed). Refer to the following figure.

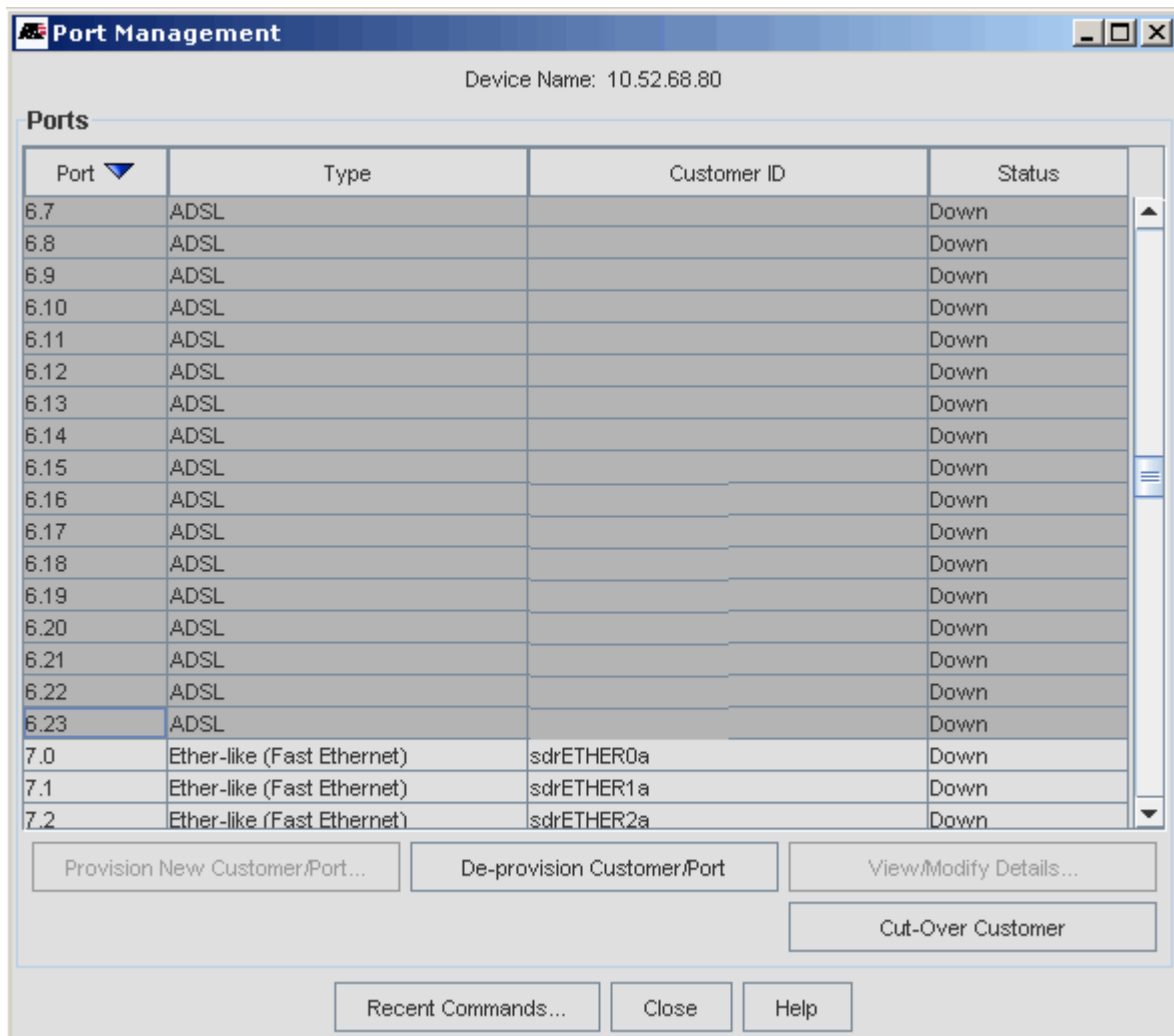

FIGURE 5-254 Original Ports Ready to be Re-Provisioned

The procedure is now complete, with the iMG/RGs up on the destination ports and passing traffic, and the original ports de-provisioned.

5.11.5 Procedure Example - Transfer of iMG to different Port

This type of procedure is more complex since when the iMG is moved to a different port, the NMS database will be updated with the new location (upstream port). Moreover, if the iMG/RG IP address was assigned using DHCP, the iMG/RG will have to renew its address; while this serves to test connectivity, it also updates DHCP-based filters on the iMAP port.

Note: The only port types selectable are ADSL, SHDSL, VDSL, and Etherlike.

5.11.5.1 Copy the Port Attributes from the Original Port to the new Port

This provision stage of cut-over is performed as a separate task since it may need to be coordinated with physical cut-over, which may need to be performed during off hours.

In this example, six iMGs are being transferred from FX10 ports to FX20 ports. Also, the source and target ports are on the same device, but the target ports could be on a different device.

Caution: If performing cut-over to a different device, the VLAN network must be pre-configured to maintain IP connectivity after the cables are moved over to the new ports. (Refer to Section 7 on how Access Islands are configured to guarantee this.) Otherwise, customer cut-over to the new port will not complete automatically.

The user first brings up the Port Management Form for the source device and highlights the appropriate source ports, which must be provisioned ports with a Customer ID, as shown in the following figure.

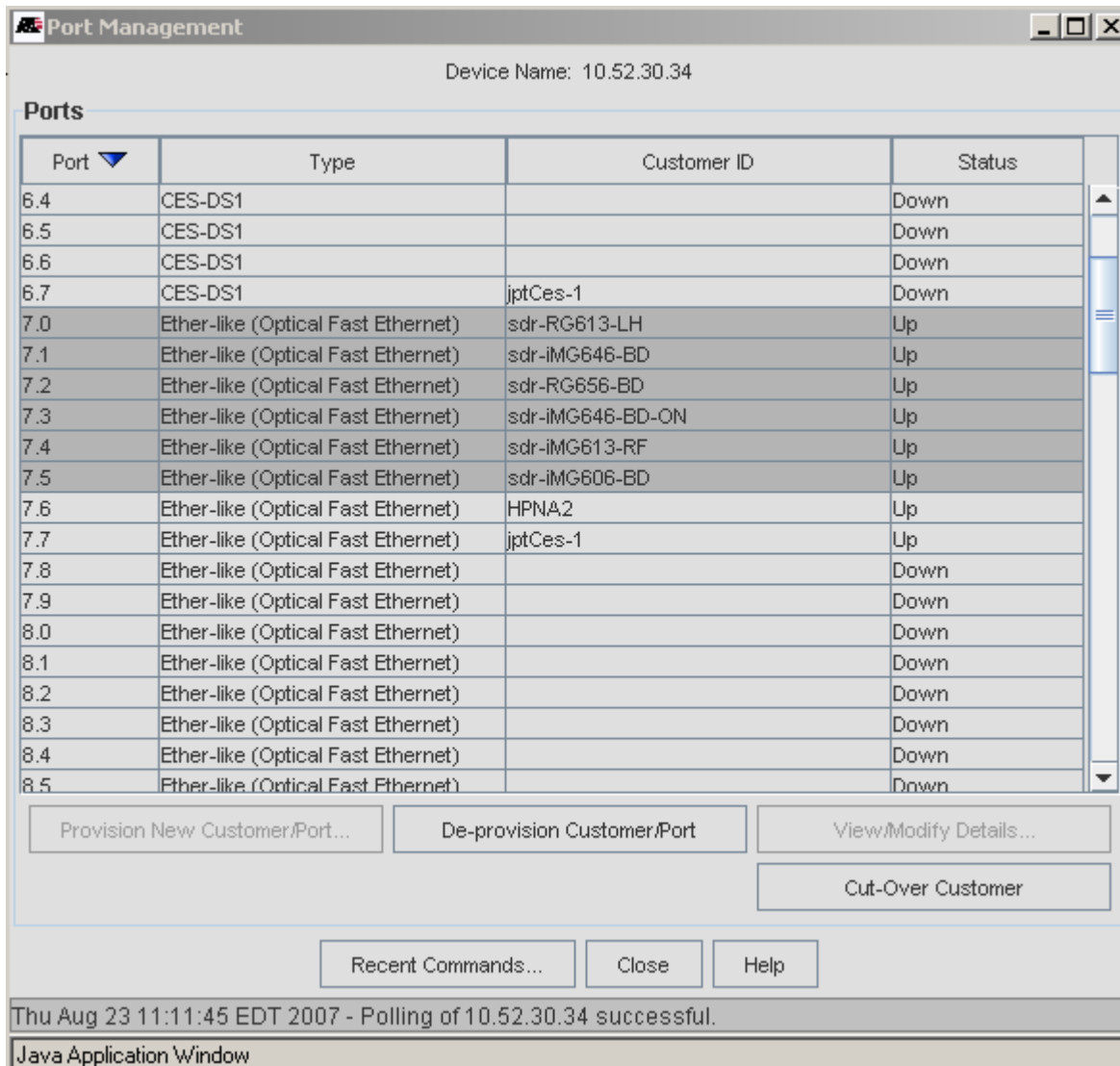

FIGURE 5-255 Selecting Source Ports for iMG/RG Cutover

The user then clicks on the **Cut-Over Customer** button. The Customer Cut-Over Panel appears, with the Source Device, Ports, Types, and Customer IDs filled in.

The user selects the Destination Device from the pull-down (in this case the same as Source Device), which makes the ports in the Dest column available for selection. The user has the option to select non-sequential ports, but in the example the user has selected ports 0 through 5 on card 8. Refer to the following figure.

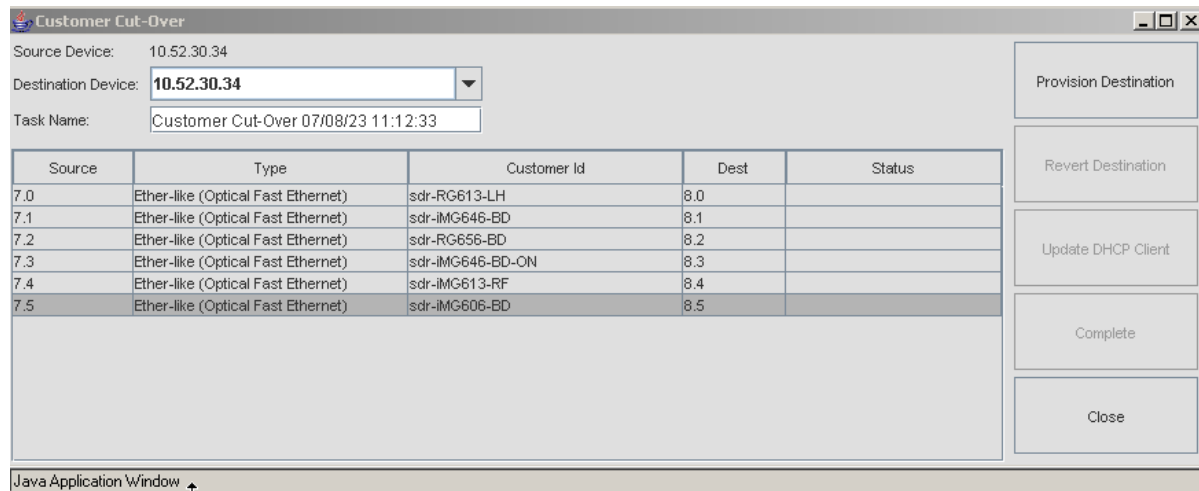

FIGURE 5-256 Data filling Destination Ports to be Provisioned

The user selects the appropriate ports and then clicks on **Provision Destination**. The Task Details panel appears, and this shows the status of each port as the attributes are copied over. (Each port goes through the status sequence Validated - Working... - Provisioned.) Refer to the following figure.

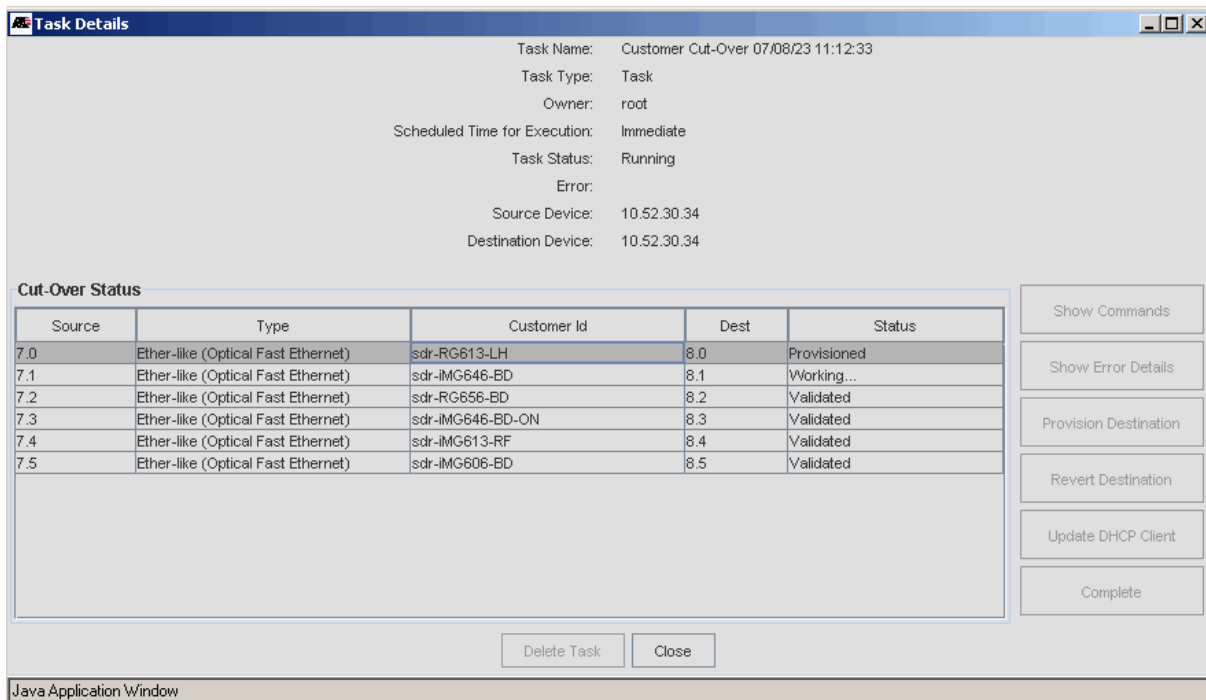

FIGURE 5-257 Task Details Panel as Target Ports are Provisioned

When all of the ports have been provisioned, the user sees that on the Port Management Panel, the source ports have a status of Up, while the target ports have the same customer ID as the source ports and have a status of Down. Refer to the following figure.

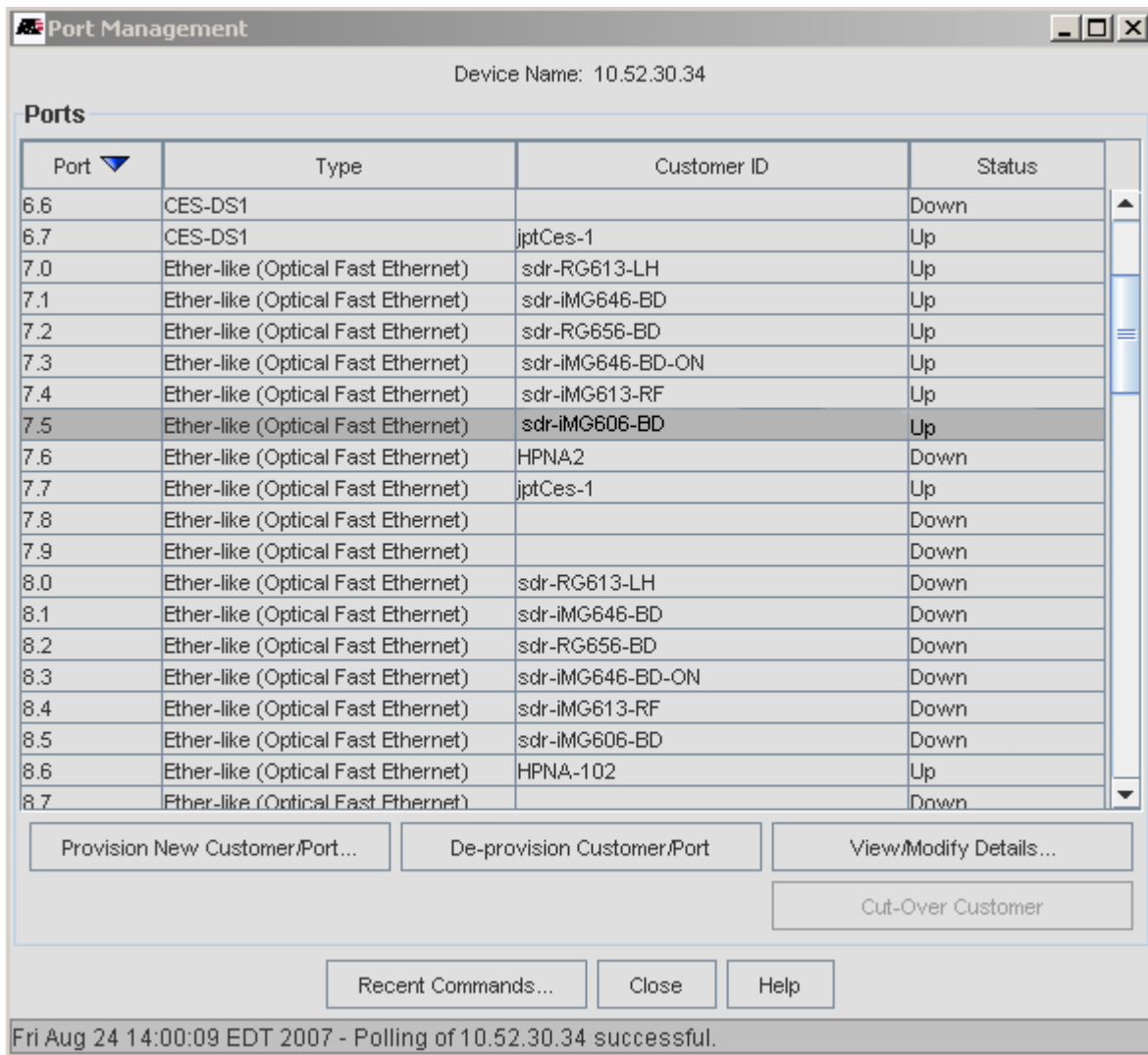

FIGURE 5-258 All Port Attributes Copied over to Target Ports

5.11.5.2 Physically disconnect/reconnect the iMGs to the new Ports

The user now disconnects the optic fiber from the FX10 port and connects it to the FX20 port.

Note: To connect the FX10 cable to the FX20 port, the user may need to change the cabling facilities.

The port is now active and is physically connected to the iMG/RG, but the iMG/RG must renew its IP address (if assigned using DHCP) to update DHCP-based filtering on the iMAP port.

5.11.5.3 Force the iMG to perform DHCP Update

In the Task Details panel, select the appropriate iMG/RGs, and then click on the **Update DHCP Client** button. As the iMG/RGs are updated, the Status changes to “DHCP Updated.” Refer to the following figures.

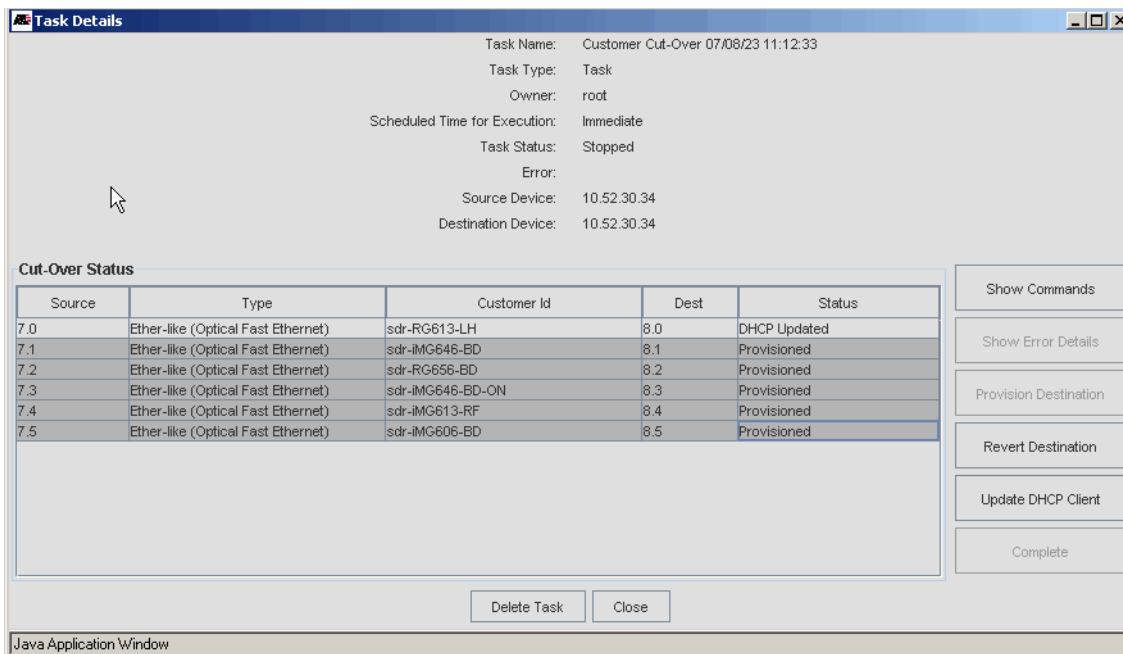

FIGURE 5-259 Selecting iMG/RGs and Updating DHCP Client

Note: The Update DHCP Client process will fail if the iMG/RG is not powered up and VLAN IP connectivity is lost. Refer to the Note in 5.11.5.1.

Total 23 | Displaying 1 to 23 | Page Length 25

Customer ID	IP Address	Type	Release	Upstream Port	Name	Gen Prof.	Inst Prof.	Video Prof.	Voice Prof.	CS Prof.
	10.52.31.118	RG624-A	3.5.0-83	10.52.30.34_10.0	RG_1187730150839					
	10.52.31.112	IMG634-WA	3.5.0-83	10.52.30.34_10.1	RG_1187730148496					
	10.52.31.117	RG634-A	3.5.0-83	10.52.30.34_10.2	RG_1187730152027					
sdr-IMG624	10.52.31.102	IMG624-A	3.5.0-83	10.52.30.34_10.3	RG_1187814489288	RGGeneralProfileRGinetProfile		RGvideoProfile		
	10.52.31.105	MG634-A	3.5.0-83	10.52.30.34_10.4	RG_1187730154589					
cutover-11-0	10.52.31.124	RG613-TX	2.5.0-51	10.52.30.34_11.0	RG_1187879784094					
sdr-RG613-LH	10.52.31.111_OLD_1	RG613-LH	2.5.0-51	10.52.30.34_7.0	RG_1187881363340	RGGeneralProfileRGinetProfile		RGvideoProfile		
sdr-IMG646-BD	10.52.31.121_OLD_1	IMG646-BD	2.5.0-51	10.52.30.34_7.1	RG_1187881192127	RGGeneralProfileRGinetProfile		RGvideoProfile	RGvoiceSIP	
sdr-RG656-BD	10.52.31.125_OLD_1	RG656-BD	2.4.0-58	10.52.30.34_7.2	RG_1187881342434	RGGeneralProfileRGinetProfile		RGvideoProfile		
sdr-IMG646-BD-ON	10.52.31.108_OLD_1	IMG646-B...	2.5.0-55	10.52.30.34_7.3	RG_1187881343700	RGGeneralProfileRGinetProfile		RGvideoProfile	RGvoiceSIP	
sdr-IMG613-RF	10.52.31.113_OLD_1	IMG613-RF	2.5.0-51	10.52.30.34_7.4	RG_1187881235125	RGGeneralProfileRGinetProfile		RGvideoProfile	RGvoiceSIP*	
sdr-IMG606-BD	10.52.31.115_OLD_1	IMG606-BD	2.5.0-51	10.52.30.34_7.5	RG_1187881235000	RGGeneralProf...RGinetProfile*				
HPINA9	10.52.31.109	IMG646-M...	3.6.0-104	10.52.30.34_7.6	RG_1187730147543					
jptCes-1	10.52.31.116	MG646-M...	3.6.0-104	10.52.30.34_7.7	RG_1187730155746	RGGeneralProf...RGinetProfile		RGvideoProfile*	RGvoiceSIP	RGcesSer
sdr-RG613-LH	10.52.31.111	RG613-LH	2.5.0-51	10.52.30.34_8.0	RG_1187882792638					
sdr-IMG646-BD	10.52.31.121	IMG646-BD	2.5.0-51	10.52.30.34_8.1	RG_1187882851745					
sdr-RG656-BD	10.52.31.125	RG656-BD	2.4.0-58	10.52.30.34_8.2	RG_1187882852683					
sdr-IMG646-BD-ON	10.52.31.108	IMG646-B...	2.5.0-55	10.52.30.34_8.3	RG_1187882853761					
sdr-IMG613-RF	10.52.31.113	IMG613-RF	2.5.0-51	10.52.30.34_8.4	RG_1187882854370					
sdr-IMG606-BD	10.52.31.115	MG606-BD	2.5.0-51	10.52.30.34_8.5	RG_1187882855380					
	10.52.31.124	RG613-TX	2.5.0-51	10.52.30.36_11.0	RG_1187877218880					
	10.52.31.124_OLD_1	RG613-TX	2.5.0-51	10.52.30.36_11.1	RG_1187874829555					
	10.52.31.123	RG613-TX	2.5.0-55	10.52.30.36_11.2	RG_1187874829558					

FIGURE 5-260 DHCP Recovery Complete

5.11.5.4 Copy over the iMG attributes

Returning to the Task Details Form, the user selects the appropriate ports and selects **Complete**. This will update the database with the rest of the iMG/RG attributes, and deprovision the source port. Refer to the following figure.

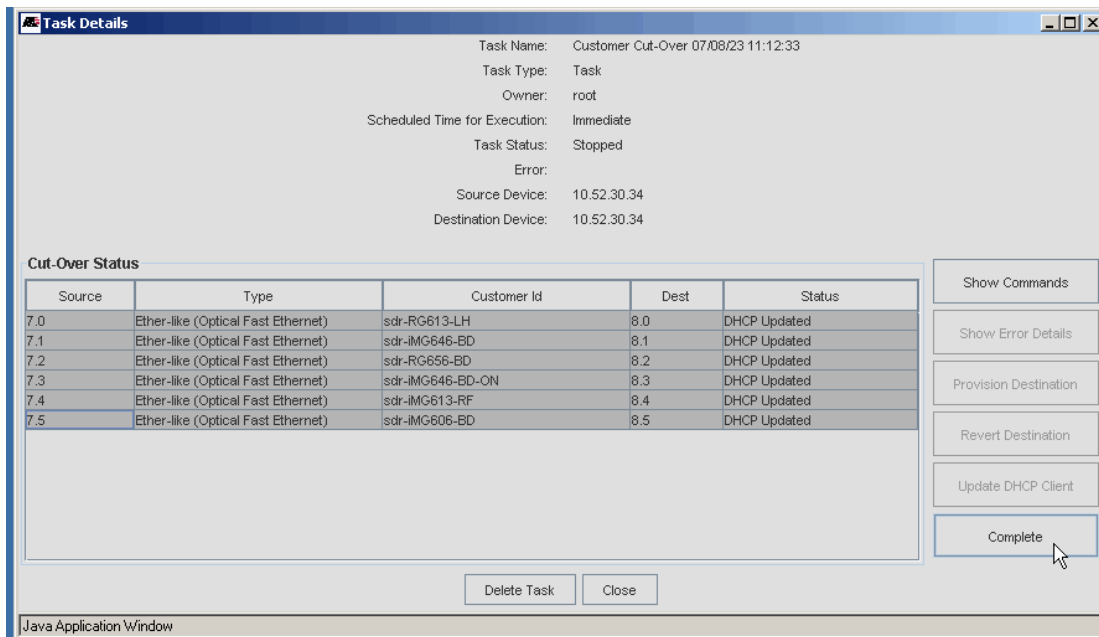

FIGURE 5-261 Completing the iMG/RG Provisioning or Cutover

When the provisioning is complete, the iMG/RG table shows the new upstream ports. (The task is deleted automatically once cut-over status for all customers has completed successfully). Refer to the following figure.

Customer ID	IP Address	Type	Release	Upstream Port	Name	Gen Prof.	Inst Prof.	Video Prof.	QoS Prof.
	10.52.31.118	RG624-A	3.5.0-83	10.52.30.34_10.0	RG_1187730150839				
	10.52.31.112	IMG634-WA	3.5.0-83	10.52.30.34_10.1	RG_1187730148496				
	10.52.31.117	RG634-A	3.5.0-83	10.52.30.34_10.2	RG_1187730152027				
sdr-iMG624	10.52.31.102	IMG624-A	3.5.0-83	10.52.30.34_10.3	RG_1187814489288	RGgeneralProfileRGinetProfile		RGvideoProfile	
	10.52.31.105	IMG634-A	3.5.0-83	10.52.30.34_10.4	RG_1187730154589				
cutover-11-0	10.52.31.124	RG613-TX	2.5.0-51	10.52.30.34_11.0	RG_1187879784094				
HPNA9	10.52.31.109	IMG646-M...	3.6.0-104	10.52.30.34_7.6	RG_1187730147543				
iptCes-1	10.52.31.116	IMG646-M...	3.6.0-104	10.52.30.34_7.7	RG_1187730155746	RGgeneralProf...	RGinetProfile	RGvideoProfile*	RGvoiceSIP
sdr-RG613-LH	10.52.31.111	RG613-LH	2.5.0-51	10.52.30.34_8.0	RG_1187882792638	RGgeneralProfileRGinetProfile		RGvideoProfile	
sdr-iMG646-BD	10.52.31.121	IMG646-BD	2.5.0-51	10.52.30.34_8.1	RG_1187882851745	RGgeneralProfileRGinetProfile		RGvideoProfile	RGvoiceSIP
sdr-RG656-BD	10.52.31.125	RG656-BD	2.4.0-58	10.52.30.34_8.2	RG_1187882852683	RGgeneralProfileRGinetProfile		RGvideoProfile	
sdr-iMG646-BD-ON	10.52.31.108	IMG646-B...	2.5.0-55	10.52.30.34_8.3	RG_1187882853761	RGgeneralProfileRGinetProfile		RGvideoProfile	RGvoiceSIP
sdr-iMG613-RF	10.52.31.113	IMG613-RF	2.5.0-51	10.52.30.34_8.4	RG_1187882854370	RGgeneralProfileRGinetProfile		RGvideoProfile	RGvoiceSIP*
sdr-iMG606-BD	10.52.31.115	IMG606-BD	2.5.0-51	10.52.30.34_8.5	RG_1187882855980	RGgeneralProf...	RGinetProfile*		
	10.52.31.124	RG613-TX	2.5.0-51	10.52.30.36_11.0	RG_1187877218880				
	10.52.31.124_OLD_1	RG613-TX		10.52.30.36_11.1	RG_1187874829555				
cutover-rg-11-0	10.52.31.122	RG613-TX	2.5.0-55	10.52.30.36_11.2	RG_1187874906568				

FIGURE 5-262 iMG/RG Table when Provisioning is Complete

5.11.5.5 View the Original Ports

Returning to the Port Management Panel, the user can see that the table has the original ports with no customer ID and a status of Down. The user now has the option of re-provisioning the ports for another interface or removing the card (once all ports have been de-provisioned and the card has been destroyed). Refer to the following figure.

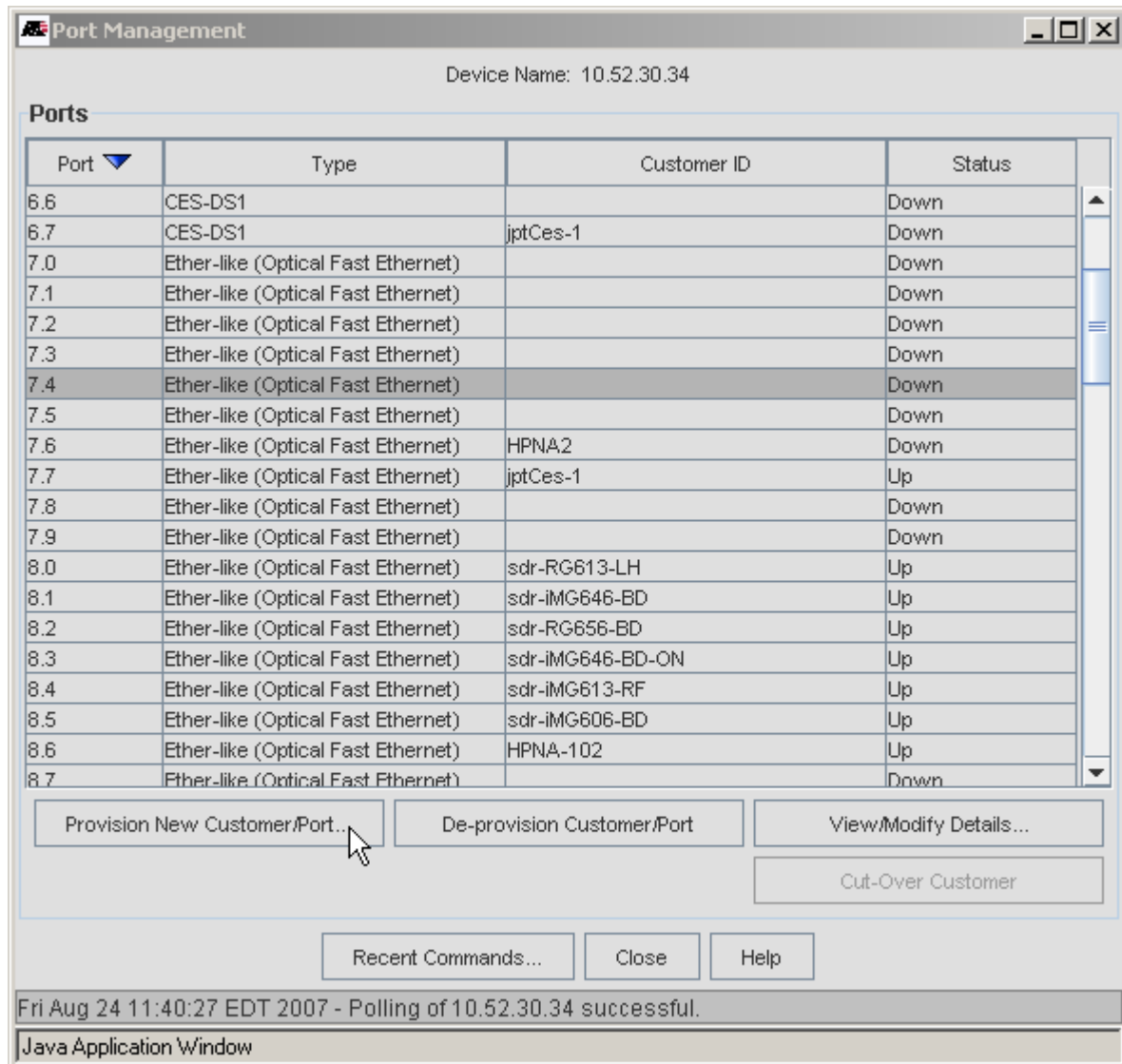

FIGURE 5-263 Original Ports Ready to be Re-Provisioned

The procedure is now complete, with the iMG/RG up on the destination ports and passing traffic, and the original ports de-provisioned.

6. Configuring Network Services

6.1 Overview

As a network management product, the AlliedView NMS can allow network-based services to be configured.

[Table 6-1](#) lists the network services that are configured in AlliedView NMS release 14.0.

TABLE 6-1 Network Services in AlliedView NMS Release 12.0

Network Service	Description	Notes / Section
Overview of Network Services		Refer to 6.1
Topology Maps and Inventory tables		6.2
Network VLANs	Creating, Extending, and Trimming	6.3 through 6.8
HVLAN and VLAN Translation	Creating on iMAP interfaces ^a	HVLAN - 6.9.2 VLAN Translations - 6.9.3
Profile Management	Creating Profiles for ports and devices	6.10
Quality of Service	Creating Traffic Profiles and applying to ports	6.11
Protection Switching	Creating Control and Protected VLANs in a ring configuration (EPSR)	6.13
Protection Switching for SuperLoop	The EPSR feature is enhanced to include the SuperLoop feature.	6.14
Customer Provisioning	Allows network service features (Profiles, Quality of Service) to be incorporated when provisioning individual customers	6.15
Dual Endpoint CES8 Provisioning	Allows two DS1/E1 endpoints to be provisioned simultaneously	6.16.5
CES between CES8 and iMG6x6MOD	Allows T1/E1 LAN card in iMG to connect to CES8 port. (Two iMG6x6's can also interconnect.)	6.16.7
Dual Endpoint NTE8 Provisioning	Allows two DS1/E1 endpoints to be provisioned simultaneously	6.17
UPC Monitoring	Displays Upstream Control Protocol (UCP) attributes for the VLAN submap and VLAN Interface Inventory	6.18
Link Discovery	A Physical link between devices will be automatically discovered if LLDP has been activated on its link ports at each end	New links are only updated during (re)discovery of the devices 5.3.13 and 6.19
Software Upgrade support for EPSR and EPSR+	During upgrade of iMAP devices, nodes are updated in proper order to keep the EPSR ring in-service. If other nodes need to be added to upgrade sequence, GUIs appear.	If EPSR had not been configured correctly, a GUI with an error message appears. Refer to 6.20 .

TABLE 6-1 Network Services in AlliedView NMS Release 12.0

Network Service	Description	Notes / Section
Diagnostic Audit	Provides the capability to run diagnostic audits on certain network entities. Currently, the auditable entities are: <ul style="list-style-type: none"> • Network VLANs • CES Circuits 	Refer to 6.21 .
Port Authentication		Refer to 6.22 .

- a. VLAN Translations may be needed when configuring the VLANs on the iMG6x6MOD. This involves interaction between the iMG and Port Profiles. Refer to [7.9.3](#)

6.1.1 Profile Management

Since most of the parameters in the configuration of certain ports or devices will be the same throughout the network, profile management is a way to set up these parameters (through profiles) and then apply them throughout the network in only a few steps and with less chance of error. Profile Management also allows the network administrator to easily re-deploy changes in a stored configuration to the devices/ports in the network. Finally, the AlliedView NMS allows the user to determine whether the configuration on a device or port still matches the configuration that was defined for it using Profile Management (and is therefore in-sync).

6.1.2 Quality of Service

The main strategy in providing QoS is to first **classify** and **segregate** traffic into separate flows. These flows can then be managed separately through the network with each flow getting a specified level of service.

The Rapiet, Switchblade, and iMAP devices provide this function, with some variation between the device types. Refer to the User Guides for each device type for detailed information on how they provide QoS.

6.1.3 Protection Switching (EPSR)

The EPSR feature protects the parts of the network that have a ring topology. Key components that are configured are Control VLANs, Domains, and Protected VLANs.

A **Control VLAN** is configured on the set of devices, and is used to send and receive control messages over the ring network. The devices that are included in the control VLAN make up the **Domain** of the control VLAN.

The VLANs that require fault protection are configured on all the ring ports and are assigned to the EPSR domain. These VLANs are called **Protected VLANs**.

6.1.4 Circuit Emulation Service (CES)

The iMAP devices use the CES8 card to transport T1 point to point across an Ethernet network. This CES is in unstructured mode; in this mode, the CES8 creates a “**pseudo-span**” across the Ethernet network that acts like a virtual wire connection that accepts a bit stream into the pseudo-span, and recreates that same stream out of the pseudo-span.

When configuring CES, the user provisions through forms the functional components of the CES8 and iMAP device, as well as the network VLANs that connect devices and networks.

Note: Future releases of iMAP software will allow structured mode transport, which allows manipulation of the individual 64kbps channels.

6.1.5 NTE8 Service

The NTE8 card is used to allow DS1/E1 facilities to connect (backhaul) the ethernet network, with both ends of the DS1/E1 connections being on iMAP 9000 devices. Refer to the *iMAP User Guide* for a complete description of the NTE8 configuration.

Note: Refer to 5.5.15 and 5.6.21 for an overview of the NTE8 card and DS1/E1 port attributes.

The NTE8 configuration always has dual endpoints, since there must be an iMAP 9000 device at each end. Moreover, each end must be correctly provisioned for the logical hierarchy (DS1, PPP, MLPP, ETH) of the NTE8. Finally, the hierarchy for each endpoint in a pair must be the same.

6.2 Topology Maps and Inventory Tables

6.2.1 Overview

To view and manipulate the network VLANs, a set of maps and tables show the configuration for the network VLANs and their status at the layer 3 and layer 2 for all their related components:

- The physical links that connect the devices
- The VLAN links that connect the VLAN interfaces
- The VLAN interfaces on the device
- The Network VLAN itself

The maps and tables that show these components are explained first, so that the menu items that create, change, and delete these components are more easily understood. [Figure 6-1](#) shows the Network Objects node tree and highlights those that are used to view and configure network VLANs.

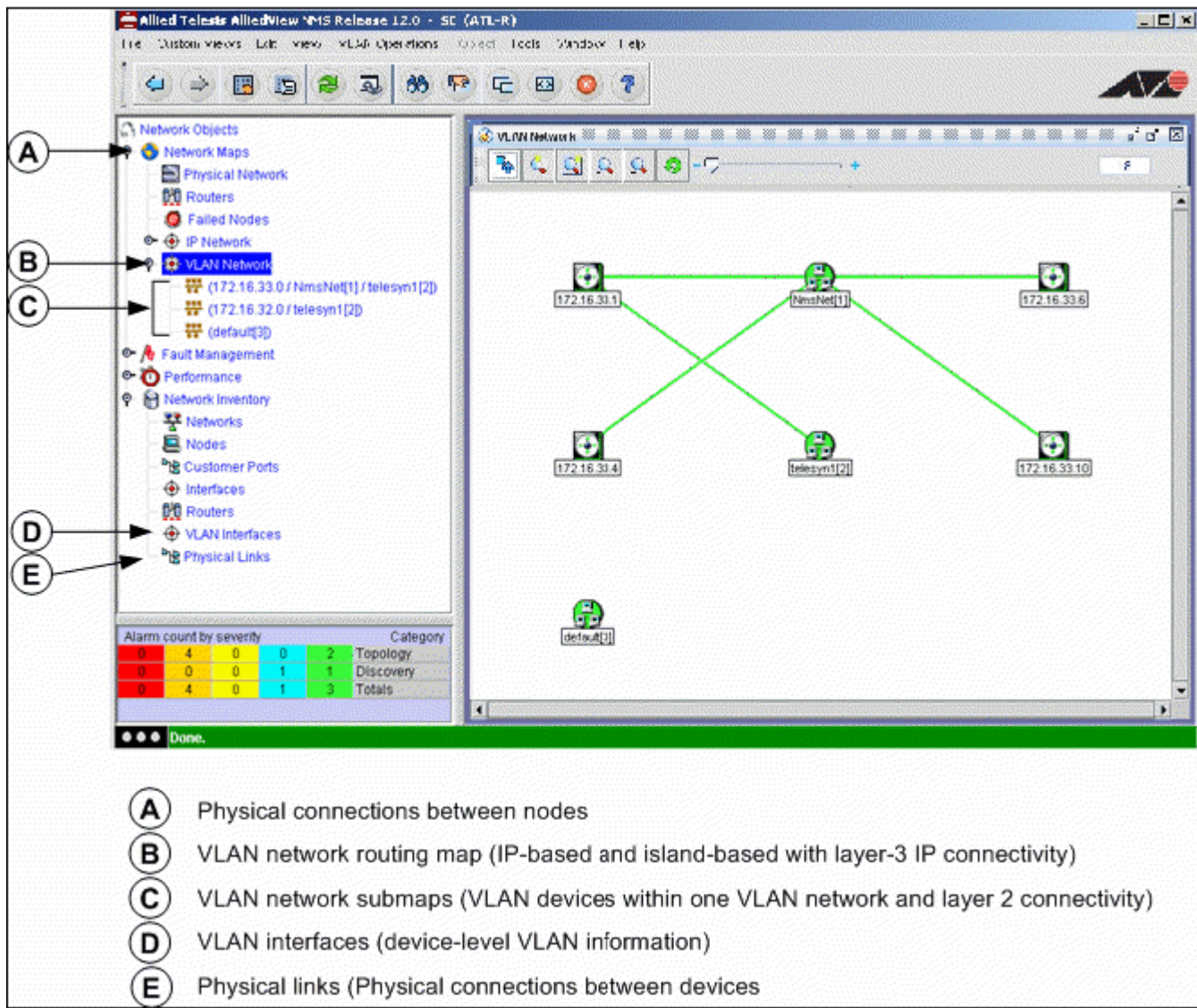

FIGURE 6-1 Network Objects used for Network VLANs

6.2.2 VLAN Network Map (Layer 3)

By containing symbols for routers and the layer 2 subnetworks, this map shows all VLAN networks and their Layer-3 (IP) connectivity.

On this map, an IP-based Network VLAN will include its router connections. An island-based Network VLAN will still appear as a layer 2 subnetwork symbol, but it will have no router connections. Refer to [Figure 6-2](#).

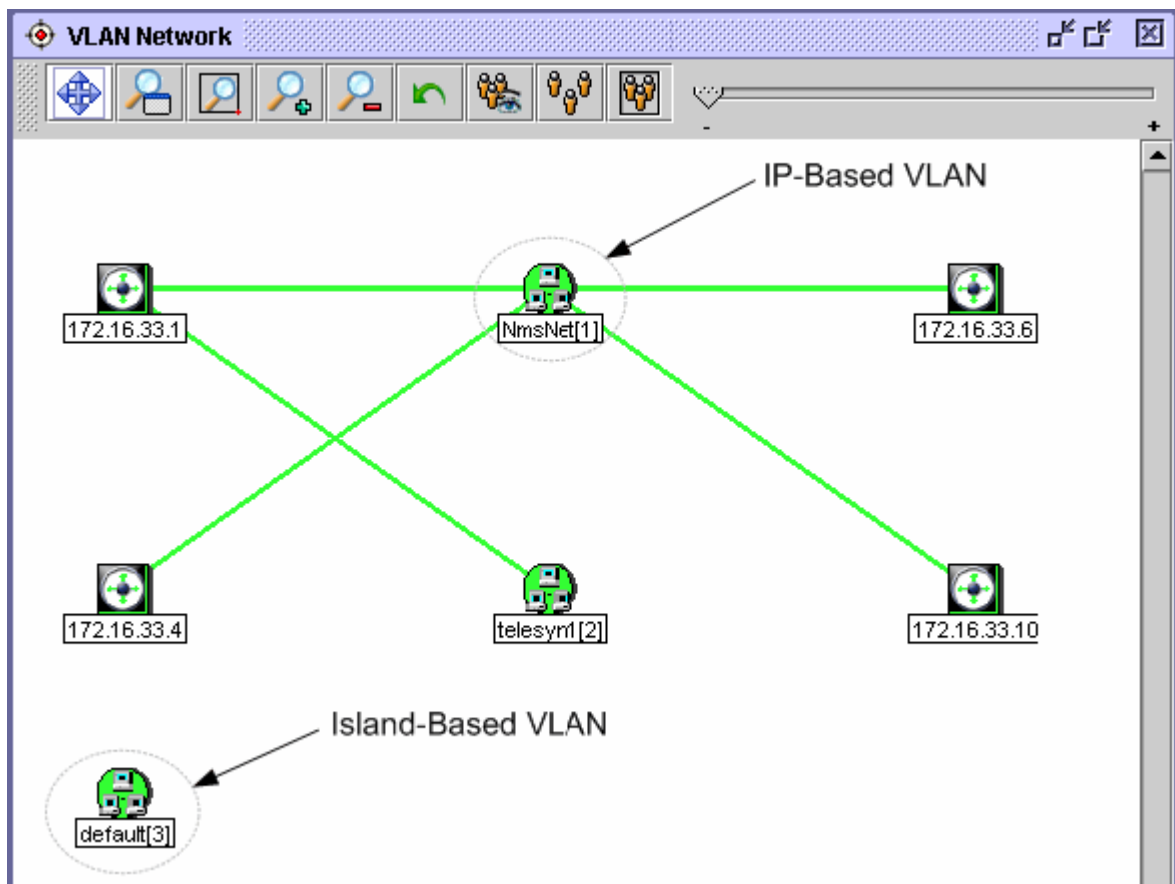

FIGURE 6-2 VLAN Network Map

Double-clicking any of the Network VLAN symbols or selecting one of the VLAN network nodes in the VLAN Network tree will open up the VLAN Network Map (layer 2), a map of the individual Network VLAN.

6.2.3 VLAN Sub Maps (Layer 2)

Each VLAN network symbol on the layer 3 topology map has its associated layer 2 topology map. These show the interfaces of the layer 2 subnetwork, as well as VLAN point-to-point connectivity (logical links) between the VLAN interfaces shown in [Figure 6-3](#). On these maps the following tooltips are available:

- When over a link, the tooltip shows the VLAN link ID, which includes the VID and port numbers.
- When over a device, the tooltip shows the VLAN interface ID.

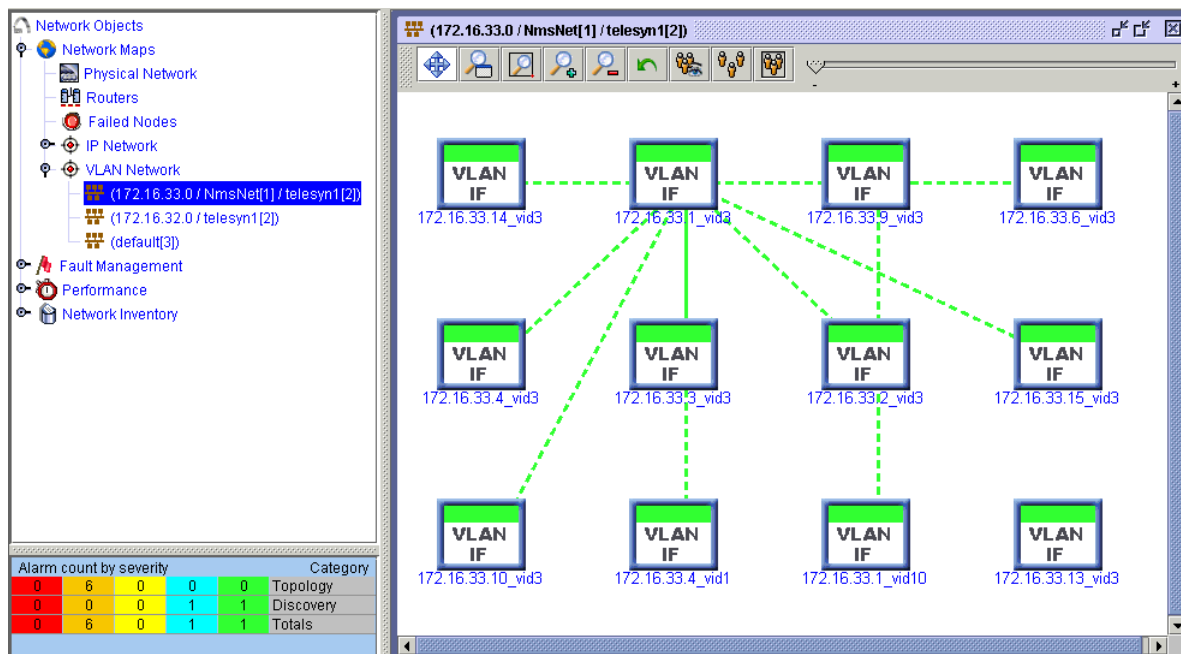

FIGURE 6-3 IVLAN Map (Layer 2)

Note: The connectivity on the layer 2 VLAN subnetwork map is derived from the physical link connectivity that is configured and viewed in the Physical Network map. If physical links have been created on the Physical Networks map, the Network VLANs will appear here. This also allows Network VLANs to be configured even if the physical connections do not exist. Refer to 6.2.4.

The naming of the Network VLANs in the VLAN Network tree is as follows:

- For IP-based Network VLANs:

<IP subnet>/<Network VLAN name>[<system-created number>]

The system-created numbers in brackets are incremented whenever a Network VLAN is created. This ensures that VLANs created with the same name can be identified. Also, there can be more than one Network VLAN on an IP submap if there are two separate Network VLANs within the same IP address.

- For island-based VLANs:

<Network VLAN name>[<system-created number in brackets>]

When a VLAN submap is the active panel, the VLAN Operations menu pull-down appears and the following options are available:

- Delete VLAN - Refer to 6.6.
- Map Properties.

6.2.4 Physical Network Map

This map shows all of the physical devices that have been discovered, as well as the physical connections that exist between the devices. For all physical connection(s) between physical devices, a single line will appear.

Note: Since the physical connection between devices may contain one or more physical links, the connection is referred to as a linkset. This is explained later in this subsection.

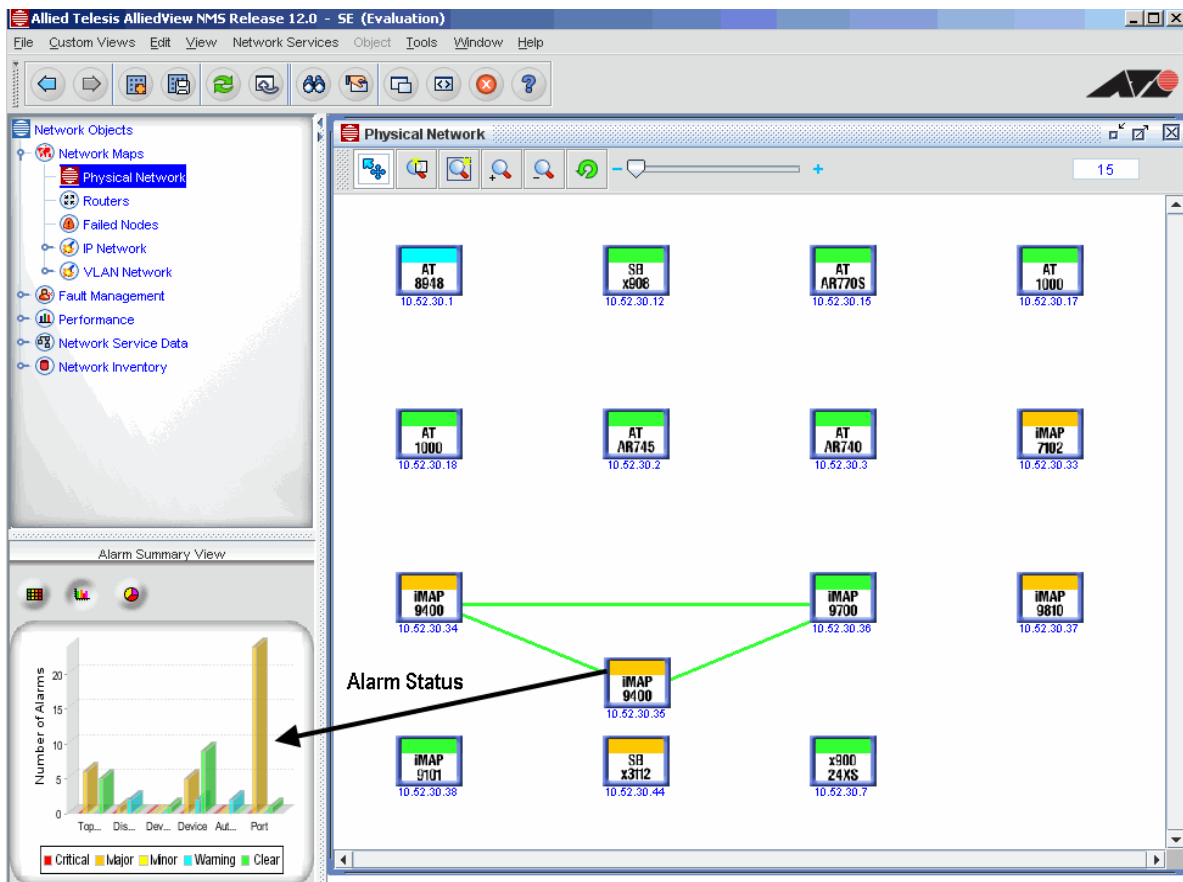

FIGURE 6-4 Physical Network Map

The ability to add, delete, and view physical links is useful in the following scenarios:

- Viewing existing Network VLANs - As the physical connections are created and configured, if there is an existing Network VLAN that uses that physical connection, its submap will automatically be configured and added to the Network nodes.
- Creating Network VLANs - If the physical connections exist, the options available on this map are used to create a Network VLAN. Devices can be chosen and the Network VLAN GUI Wizard can be used to create and configure a Network VLAN. Refer to 6.3.1.
- Modeling Network VLANs for study - A physical connection can be created that does not actually exist, and then a VLAN configuration can be associated with it. This allows Network Administrators to study the Network VLAN and ensure it follows the topology they desire before connecting the physical link.

This map also shows the status of the devices and links and if any alarms are present. Refer to 6.2.7.

When the Physical Network map is the active panel, the **Network Services** menu pull-down appears and the following options are available. (These also appear when you right-click the device.)

- Link Operations - Used to add and delete links between two nodes. Refer to Figure 6-7.
- VLAN - Accesses a submenu that includes the following:
 - Create VLAN - Creates a Network VLAN and all of its components
 - Show VLANs - Lists the Name, ID, and subnets for all Network VLANs
 - Delete VLAN - Delete a Network VLAN

- Network VLAN Manager - Shows all Network VLANs in a hierarchy

To create a physical link, select **Network Service -> Link Operations** from the pull-down menu or right click anywhere on the map area. The Layer 2 Links form appears, as shown in [Figure 6-5](#). This form displays the links associated with the Nodes and/or Links that are currently selected. If no links are selected, it displays all Links in the NMS database. These forms will also reflect any changes made from other forms and even other NMS Clients

Note: A single visible line between two devices on the Physical Networks map may represent one or more than one link. (Double-clicking on the link will show the number of links.) Therefore, a link symbol on the map is properly called a **linkset**, so when creating a physical link you are actually creating one of the links in the linkset. This is important when creating model VLANs, since they use physical links that do not actually exist. When creating a model physical link (does not actually exist), it is recommended to go to the Physical Links table in Network Inventory and UnManage that link. Doing this will unmanage any associated model VLAN links causing them to be displayed with a gray color, which indicates that they are modeled links.

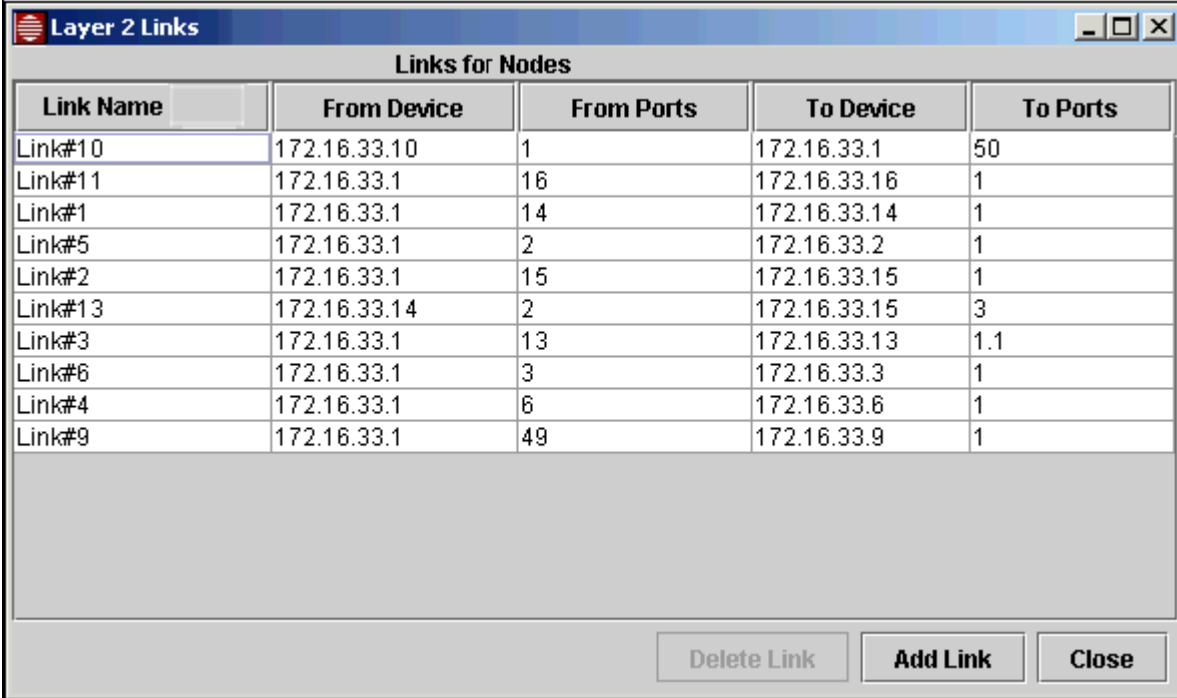

Layer 2 Links				
Links for Nodes				
Link Name	From Device	From Ports	To Device	To Ports
Link#10	172.16.33.10	1	172.16.33.1	50
Link#11	172.16.33.1	16	172.16.33.16	1
Link#1	172.16.33.1	14	172.16.33.14	1
Link#5	172.16.33.1	2	172.16.33.2	1
Link#2	172.16.33.1	15	172.16.33.15	1
Link#13	172.16.33.14	2	172.16.33.15	3
Link#3	172.16.33.1	13	172.16.33.13	1.1
Link#6	172.16.33.1	3	172.16.33.3	1
Link#4	172.16.33.1	6	172.16.33.6	1
Link#9	172.16.33.1	49	172.16.33.9	1

FIGURE 6-5 Layer 2 Links Form

Note: This Form also includes Link Type, Discovered By, and Parent Link. Refer to [6.22](#) for an example that uses these columns.

From this list, the Add Link button is used to create a link between two devices. The **Add Links** form appears, as shown in [Figure 6-6](#).

FIGURE 6-6 Add Links Form for a Physical Connection

From this form, enter the name that will be given to the link. Use the **Select Device** to select which devices will be the end points of the link. Once the devices are selected, the available ports are shown in the pull-down menu for the Port. When the **Apply** button is clicked, the new link is automatically added to the Layer 2 Links table.

A link can also be deleted using the Layer 2 Links form. Once a link is highlighted, the Delete button is enabled, and the link can be deleted.

Note: When deleting a physical link, be aware that if the link is carrying logical VLAN links, these will be deleted from the VLAN submaps. Deleting links will not have any impact on the devices themselves.

When a specific link is highlighted, the **Physical Link** pull-down appears and the following options are available:

- **Link Operations** - This invokes the Layer 2 Links form.
- **Show VLANs** - Show all the Network VLANs that use the link.
- **Properties** -The symbol properties.
- Managed Object Properties - The MO properties.
- Manage/UnManage - Makes the device managed or unmanaged by the AlliedView NMS.
- Update Status - The AlliedView NMS polls the link for its status.

6.2.5 VLAN Interfaces Inventory Table

In the Network Inventory Objects tree, the VLAN Interfaces table lists the inventory for all VLAN IFs. Like all inventory panels, it can be sorted by column (by clicking on the column head), and the number of rows listed can be controlled. Also, the entire table or selected rows can be exported to an external file or to your Web browser.

Figure 6-7 shows the Network Inventory Table for VLAN Interfaces, while Table 6-2 describes the columns.

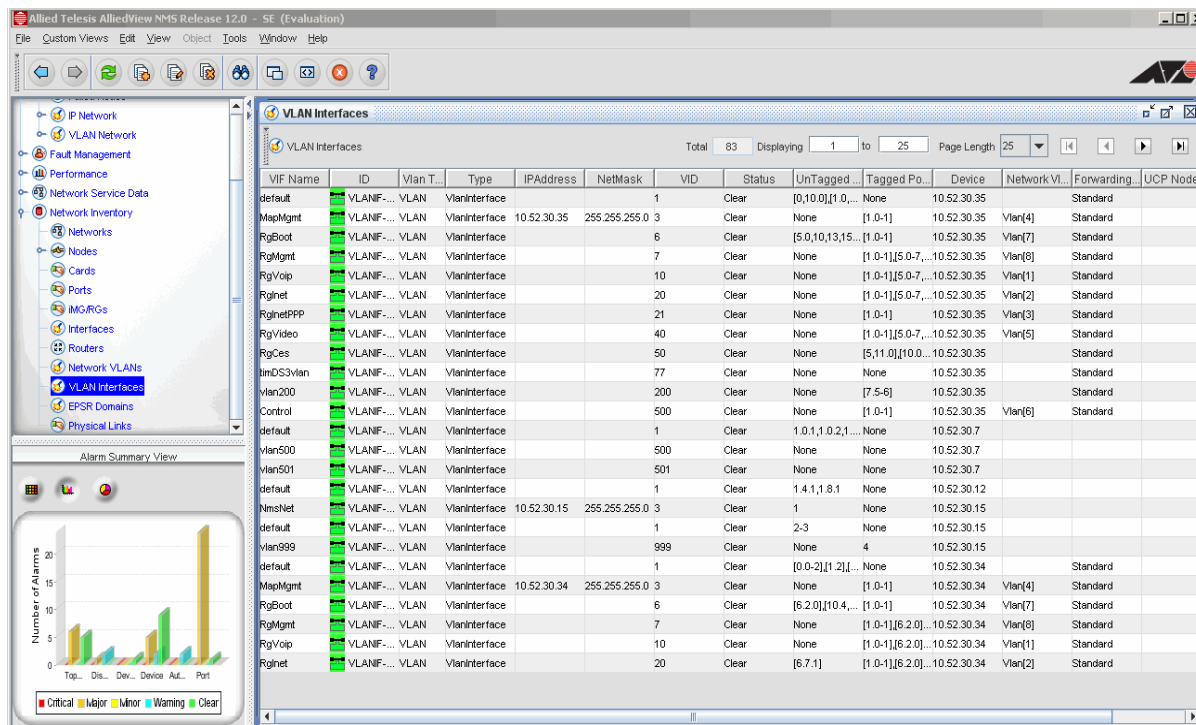

FIGURE 6-7 Network Inventory for VLAN Interfaces

TABLE 6-2 VLAN Interfaces Inventory Table

Column	Description
VLAN Interface Name	The name of the VLAN interface on the device, which can be specified when creating a Network VLAN using the GUI wizard. Refer to 6.3.1.
ID	The VLAN interface ID (device name and VLAN ID).
Type	The type of interface. Always VlanInterface in this inventory table.
IPAddress	If the VLAN Interface is IP-based, its subnetwork.
NetMask	The net mask for the subnetwork.
VID	The VLAN ID number.
Status	Alarm Status. If no alarms, the status is Clear.
Untagged Ports	On the device, the ports that are labeled as untagged for the VLAN.
Tagged Ports	On the device, the ports that are labeled as tagged for the VLAN.
Device	The device name.
Network VLAN	The network VLAN to which this VLAN interface belongs.

When the VLAN Interfaces Inventory table is the active panel and one row is selected, the **VLAN Interface** menu pull-down appears and the following options are available:

- **Configure VLAN Interface** - This brings up the **VLAN Interface Configuration** form, and allows VLANs to be configured on the individual device. This is the same form displayed when provisioning a device, and is described in 5.4.
- **Extend VLAN** - This is described in 6.4.
- **Alarms/Events** - This will invoke the Fault Management tables for Alarms and Events specific to the VLAN IF.

- **Managed Object Properties** - The base properties of the interface, including the IP address and netmask if it is part of a VLAN.
- **Delete Object and Traces** - This will delete the VLAN IF and all its sub-elements, so there is a confirmation window.
- **Manage/UnManage** - The interface will (or will no longer) be polled by the AlliedView NMS. The color of the row icon turns to gray.
- **Update Status** - The AlliedView NMS polls the device for its status.

6.2.6 Physical Links Inventory Table

For any physical link that is created from the Physical Network map or already exists, there is a row in this table.

Like all inventory panels, it can be sorted by column (by clicking column heading), and the number of rows listed can be controlled. Also, the entire table or selected rows can be exported to an external file or to your Web browser

Figure 6-8 shows the Network Inventory Table for VLAN Interfaces, while Table 6-3 describes the columns.

Link Name	ID	Source Device	Source Port	Dest. Device	Dest. Port	Status	Link Type	Discovery
LINK-10.52.30.35-1.1--10.52.30.34-1.1	LINK-10.52.30.35-1.1--10.52.30.34-1.1	10.52.30.35	1.1	10.52.30.34	1.1	Clear		LLDP
LINK-10.52.30.36-4.0--10.52.30.1-50	LINK-10.52.30.36-4.0--10.52.30.1-50	10.52.30.36	4.0	10.52.30.1	50	Clear		LLDP
LINK-10.52.30.36-4.1--10.52.30.35-1.0	LINK-10.52.30.36-4.1--10.52.30.35-1.0	10.52.30.36	4.1	10.52.30.35	1.0	Clear		LLDP
LINK-10.52.30.36-4.2--10.52.30.34-1.0	LINK-10.52.30.36-4.2--10.52.30.34-1.0	10.52.30.36	4.2	10.52.30.34	1.0	Clear		LLDP
LINK-10.52.30.38-5.1--10.52.30.37-4.2	LINK-10.52.30.38-5.1--10.52.30.37-4.2	10.52.30.38	5.1	10.52.30.37	4.2	Clear		LLDP
LINK-10.52.30.39-1.3--10.52.30.37-1.0	LINK-10.52.30.39-1.3--10.52.30.37-1.0	10.52.30.39	1.3	10.52.30.37	1.0	Clear		LLDP
LINK-10.52.30.39-10.0--10.52.30.38-5.0	LINK-10.52.30.39-10.0--10.52.30.38-5.0	10.52.30.39	10.0	10.52.30.38	5.0	Clear		LLDP
LINK-10.52.30.39-10.1--10.52.30.1-52	LINK-10.52.30.39-10.1--10.52.30.1-52	10.52.30.39	10.1	10.52.30.1	52	Clear		LLDP
LINK-10.52.30.39-8.14--10.52.30.37-4.6	LINK-10.52.30.39-8.14--10.52.30.37-4.6	10.52.30.39	8.14	10.52.30.37	4.6	Clear	LAG	LLDP
LINK-10.52.30.39-8.15--10.52.30.37-4.7	LINK-10.52.30.39-8.15--10.52.30.37-4.7	10.52.30.39	8.15	10.52.30.37	4.7	Clear	LAG	LLDP
LINK-10.52.32.2-1.0.1--10.52.30.1-51	LINK-10.52.32.2-1.0.1--10.52.30.1-51	10.52.32.2	1.0.1	10.52.30.1	51	Clear		LLDP
LINK-10.52.32.23-1.0.7--10.52.32.21-1.0.9	LINK-10.52.32.23-1.0.7--10.52.32.21-1.0.9	10.52.32.23	1.0.7	10.52.32.21	1.0.9	Clear	LAG	LLDP
LINK-10.52.32.23-1.0.9--10.52.32.21-1.0.7	LINK-10.52.32.23-1.0.9--10.52.32.21-1.0.7	10.52.32.23	1.0.9	10.52.32.21	1.0.7	Clear	LAG	LLDP
LINK-10.52.32.3-1.4.3--10.52.32.23-1.0.48	LINK-10.52.32.3-1.4.3--10.52.32.23-1.0.48	10.52.32.3	1.4.3	10.52.32.23	1.0.48	Clear		LLDP
LINK-10.52.32.3-1.4.5--10.52.32.22-7.0.23	LINK-10.52.32.3-1.4.5--10.52.32.22-7.0.23	10.52.32.3	1.4.5	10.52.32.22	7.0.23	Clear		LLDP
LINK-10.52.32.3-1.4.7--10.52.32.21-1.0.47	LINK-10.52.32.3-1.4.7--10.52.32.21-1.0.47	10.52.32.3	1.4.7	10.52.32.21	1.0.47	Clear		LLDP
LINK-10.52.32.3-1.5.1--10.52.32.2-1.1.1	LINK-10.52.32.3-1.5.1--10.52.32.2-1.1.1	10.52.32.3	1.5.1	10.52.32.2	1.1.1	Clear		LLDP
LINK-10.52.32.5-2.0.50--10.52.32.2-1.2.1	LINK-10.52.32.5-2.0.50--10.52.32.2-1.2.1	10.52.32.5	2.0.50	10.52.32.2	1.2.1	Clear		LLDP

FIGURE 6-8 Physical Links Inventory Table

TABLE 6-3 Physical Links Inventory Table

Column	Description
Link Name	The name given when creating a Network VLAN using the GUI wizard.
ID	The physical link ID (device names and port numbers at each end of the link).
Source Device	The name of the source device.
Source Port	The physical port on the source device.
Dest. Device	The name of the destination device.
Dest. Port	The physical port on the destination device.
Status	Alarm Status. If no alarms, the status is Clear.
Link Type	Specifies if the link provides a feature, such as LAG
Discovery	The protocol used to discover the link, such as LLDP

When the Physical Links table is the active panel, the **Link** menu pull-down appears and the following options are available:

- **Managed Object Properties** - The base properties of the physical link.
- **Alarms/Events** - This will invoke the Fault Management tables for Alarms and Events on the selected link.
- **Manage/UnManage** - The link may be set to unmanaged to indicate that it is not a real link, but rather a modelled link. The color of the link will be gray and the link will not change status based on alarms.

Note: As mentioned in 6.2.4, when creating a model physical link (does not actually exist), it is recommended to go to the Physical Links table in Network Inventory and UnManage that link. Doing this will unmanage any associated model VLAN links.

- **Update Status** - The AlliedView NMS checks the alarm database for its status. The status is updated automatically, so this update status request should not be necessary for links.

6.2.7 Alarm Indicators from the Maps and Inventory Tables

When there is an alarm condition for any component in the network VLAN configuration, the following categories of alarms may be raised:

- Port
- VLAN IF
- Link
- Discovery
- Topology

For any component in any map or table, right-clicking the component brings up the Network Events or Alarms table for only that component and the condition can be examined more closely.

6.3 Creating Network VLANs

From the Physical Network map, a Network VLAN can be created using a GUI wizard that goes through all of the steps to create all of the needed components.

Note: The user can also highlight a VLAN that already exists in the VLAN Network node and right click; all of the VLAN tasks are accessible.

6.3.1 Creating Initial VLAN Information

To create a network VLAN, select one or more nodes on the Physical Network map. This can be done by clicking one node, and then holding down the Shift key while selecting other nodes. Links between nodes can be selected as well. Select **Network Services** -> **VLAN** -> **Create VLAN** from the pull-down menu, or right-click one of the nodes. The **Create VLAN Net** form will appear, as shown in Figure 6-9. The form will be pre-populated with the selected nodes and links. Table 6-4 shows the options available.

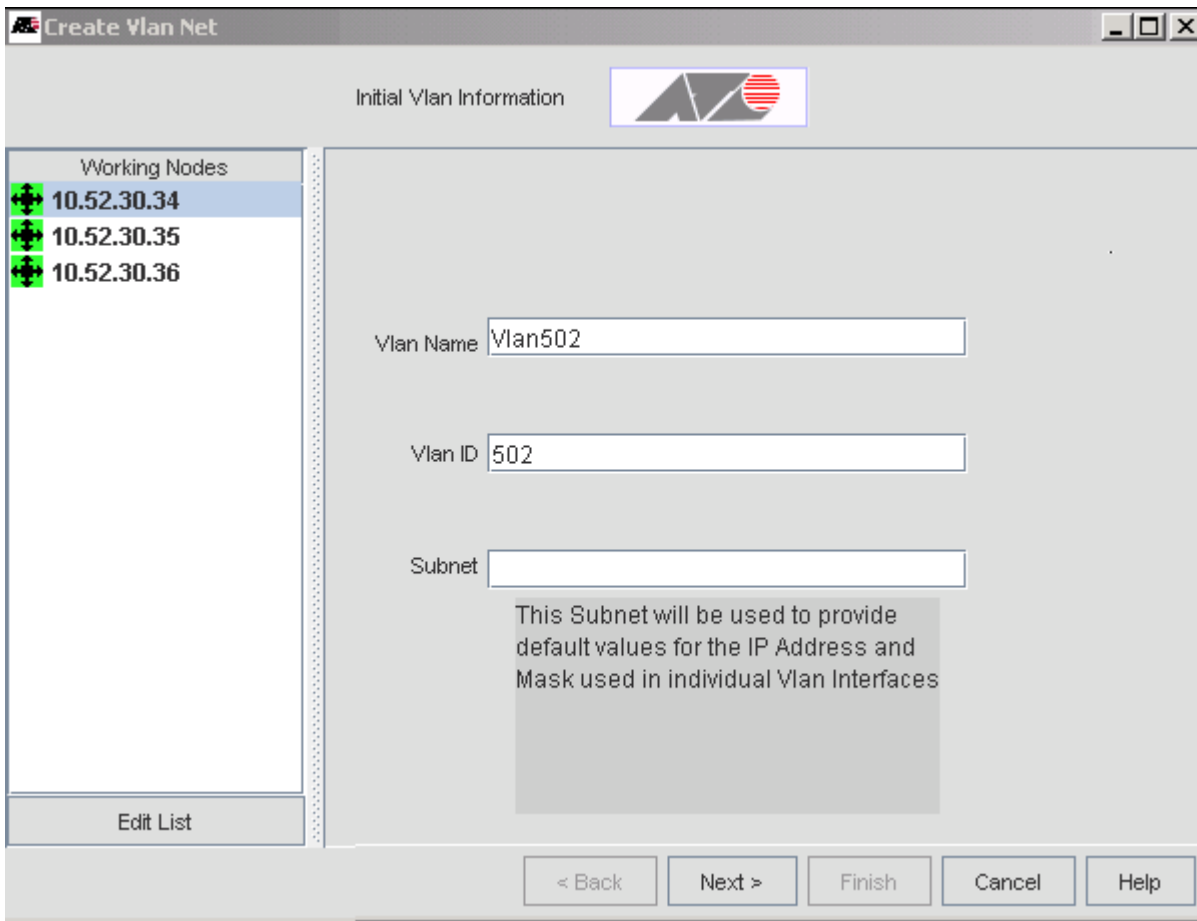

FIGURE 6-9 Create VLAN Net Form - Initial VLAN Information

TABLE 6-4 Create VLAN Net Form

Column	Description
Working Nodes	Nodes that are to be included in the Network VLAN. Nodes not in the original working nodes can be included in a VLAN by following an existing or newly created link to a new node. This is not recommended, though, as the auto-selected VLAN ID and VLAN Name may clash with entries already on these new nodes. To add or delete nodes, select Edit List .
Vlan Name	The name for the Network VLAN. This is usually descriptive text and includes the VID. The default is Vlan and a number selected by the AlliedView NMS.
Vlan ID (VID)	The VLAN ID number. This VID will be applied to each device VLAN interface during creation.
subNet	If this Network VLAN is to be IP-based, enter the subnetwork and the mask bitset, such as 172.16.32.0/24. If this field is left blank, an island-based Network VLAN is being created.
Next	If there are Working Nodes and at least the Vlan and VID fields are filled, clicking this button goes to the next form. (The Back and Finish buttons are always disabled in this initial form.)
Cancel	Dismisses the form and saves no data.

6.3.2 Modify the Network VLAN Link Configuration

Once **Next** is clicked, the VLAN links (and the physical links that they go over) can be added, changed, or removed. This is done with the **Modify Links** form, as shown in the following figure.

Modify Links

Vlan Path Links

Link Name	From Device	From Ports	To Device	To Ports

Remove Links

Add Links

Available Links From: 10.52.30.34

Link Name	From Ports	To Device	To Ports
LINK-10.52.30.35-1.1--10.5...	1.1	10.52.30.35	1.1
	7.0	10.52.30.36	6.4
LINK-10.52.30.36-6.2--10.5...	1.0	10.52.30.36	6.2

Create New Link Add Links

FIGURE 6-10 Create VLAN Net Form - Modify Links

Any links that were selected from the Physical Map when the Wizard was started are displayed in the **Vlan Path Links** table on this form. The available physical links from each device are listed in the **Add Links** subform. Selecting the desired link from the Add Links list and then clicking **Add Links** (now active) will place the selected link as one of the VLAN Path links, as shown in [Figure 6-11](#).

Note: When a link from one device is added to the VLAN Path Links, the next device is selected in the Add Links subform. This would follow the normal procedure of going to the next “hop” in the Network VLAN. This procedure allows one to “walk” from one device to the next over the interconnecting physical links, resulting in a connected set VLAN interface that will form the broadcast domain of the created VLAN.

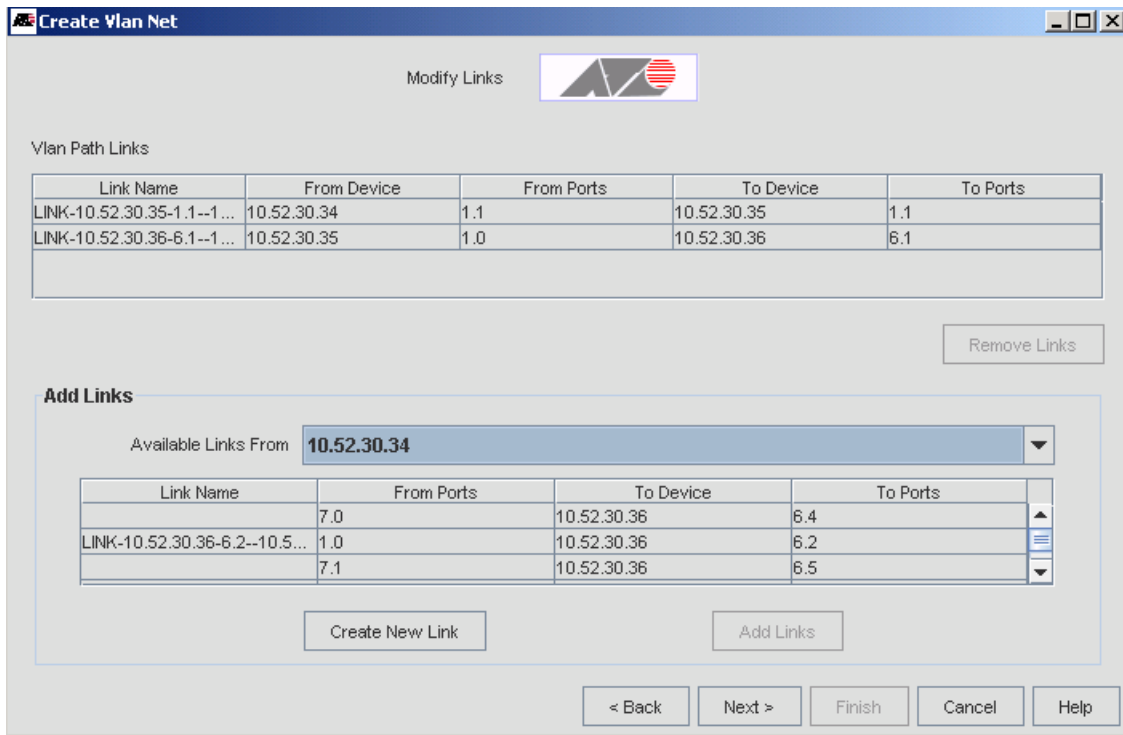

FIGURE 6-11 Adding Vlan Path Links - File

There is also the option to create a physical link by clicking **Create New Link**, and a new physical connection between two devices and their ports can be created. This uses the same form as shown in 6.2.4.

6.3.3 Configure the VLAN Interfaces (Service Ports)

The next step is to configure the VLAN interfaces by adding any service ports to the Network VLAN. Service ports are those ports configured on the individual node and are the local VLAN interfaces. These ports can be configured as part of configuring VLAN ports for an individual device (as shown in Section 5.4), or they can be configured here.

When clicking **Next** in the **Modify Links** form, the **Configure VLAN Interfaces** form appears, as shown in Figure 6-12.

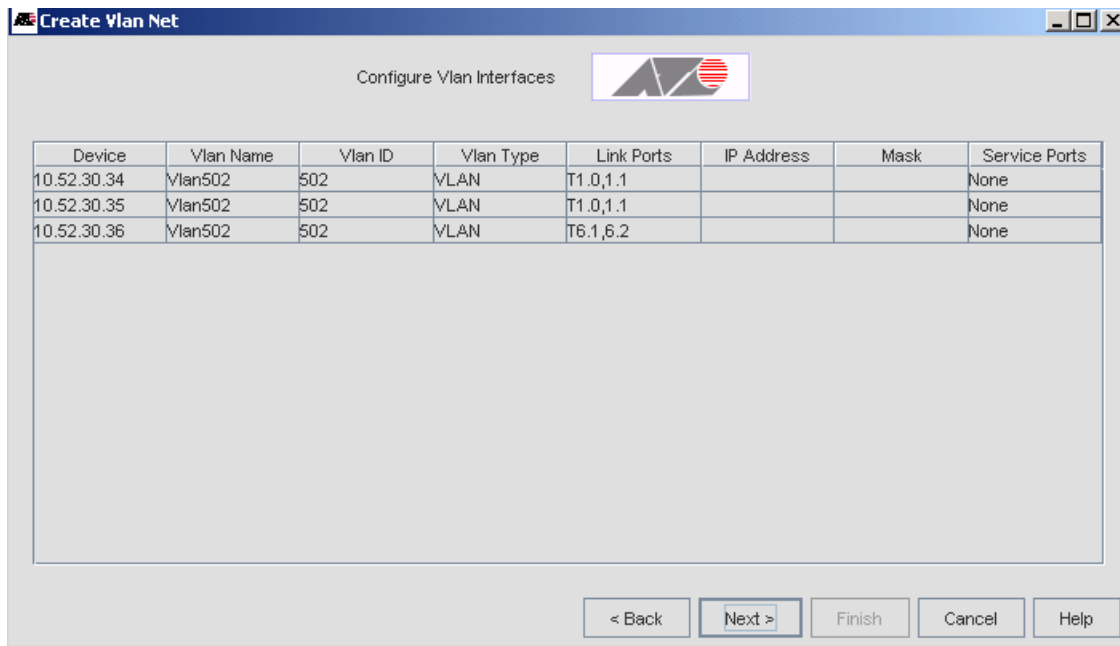

FIGURE 6-12 Configure VLAN Interface Form - File

If this is an IP-based VLAN, you can enter the IP address in the cell in the **IpAddress** column, and the network mask in the cell in the **Mask** column. This must be extended to a specific address within the subnet. For the port row, click the IpAddress cell and enter the IP address, and then click the Mask cell and enter the network mask.

Note: If a VLAN subnet was entered on the first panel, when you click the IpAddress cell, the cell will be filled with the subnet address, and when you click the Mask cell for that row (or any other cell), the Mask cell will be filled with the mask value for the subnet. Typically, the Mask cell value will not need to be changed.

To configure service ports, click the **cell** in the **Service Ports** column and the **Edit Ports** form appears, as shown in [Figure 6-13](#).

The screenshot shows a window titled "Edit Ports" with a close button in the top right corner. The window is divided into two main sections: "Tagged Ports" on the left and "Untagged Ports" on the right. Each section contains a list box with a scroll bar. The "Tagged Ports" list box contains the following items: "None", "5.0.0", "5.1.0", "5.2.0", "5.3.0", "5.4.0", "5.5.0", "5.6.0", "5.7.0", "5.8.0", "5.9.0", and "5.10.0". Below the list box is a text field containing "None". The "Untagged Ports" list box contains the same items: "None", "5.0.0", "5.1.0", "5.2.0", "5.3.0", "5.4.0", "5.5.0", "5.6.0", "5.7.0", "5.8.0", "5.9.0", and "5.10.0". Below the list box is a text field containing "None". At the bottom right of the window are two buttons: "Close" and "Cancel".

FIGURE 6-13 Edit Ports Form

Clicking on the ports and then clicking **Close** adds these to the Service Ports cell that was chosen. Multiple ports may be selected pressing the Shift or Ctrl key while clicking. The same port must not be selected in both the **Tagged Ports** and **Untagged Ports** lists. This error will be detected when the **Close** button is clicked. The form will not close until the error is corrected.

Once the VLAN Interfaces have been configured, clicking **Next** will invoke the **Test Network VLAN** form, which ensures that the Network VLAN has the ports configured correctly so that all ports can send data to all other ports within that Network VLAN. If there is a problem, a Problems table is added to the form, with a description, as shown in [Figure 6-14](#). Some errors (warnings) can be ignored. In this case, the checkbox in the Ignore column can be checked and the Network VLAN will be created anyway. Other errors will prevent the VLAN from being created. These errors must be fixed by backing up to the previous panels and correcting the problem.

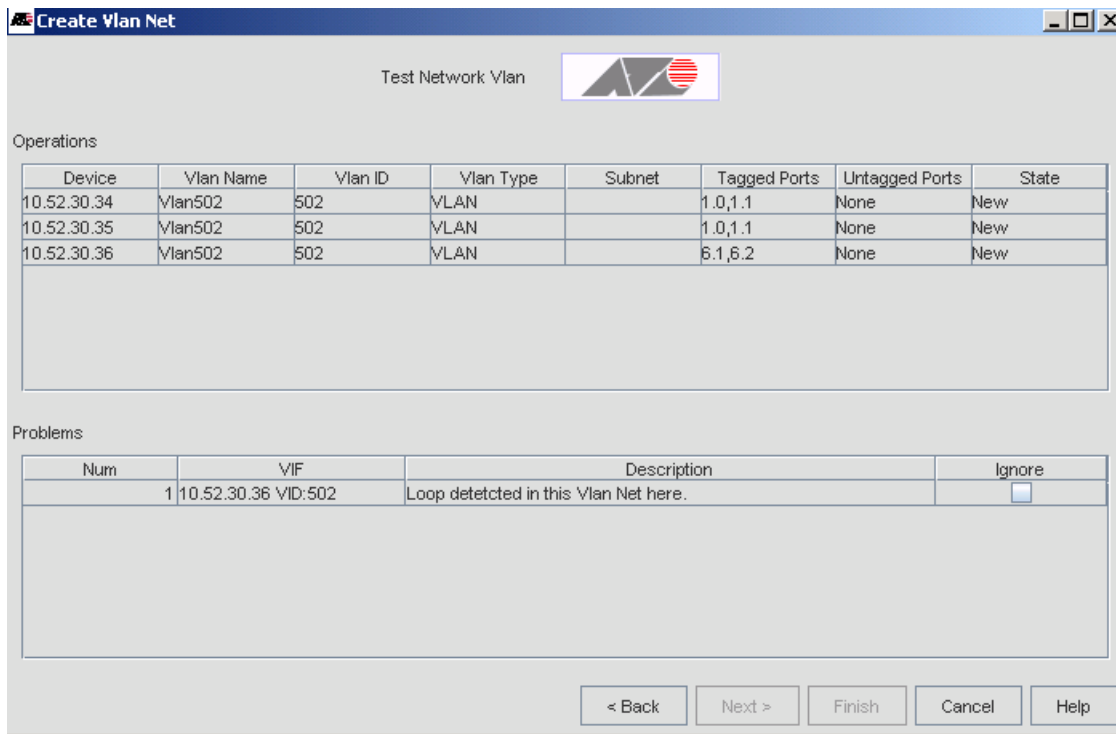

FIGURE 6-14 Test Network VLAN Form (with error and option to ignore)

6.4 Extending Network VLANs

Once a Network VLAN is created, the general procedure for extending it is as follows:

1. Open the Network VLAN submap associated with the VLAN. This can be done by right-clicking the desired VLAN on the main Network VLAN map and selecting **Open Submap** from the pop-up menu.
2. In the VLAN submap, right-click the VLAN IF from which you want to extend the VLAN, and then select **Extend Vlan** from the pop-up menu. The **Extend Network Vlan** form will appear.

Note: You can also extend a VLAN from a particular VLAN IF by right-clicking the VLAN IF in the VLAN Interfaces table, and then selecting **Extend Vlan** from the pop-up menu.

3. Select or create a link over which to extend the VLAN.
4. Create/select a new VLAN IF on the device at the other end of the selected link. This new VLAN IF will become part of the network VLAN.

The concept behind this procedure is shown in the following figure.

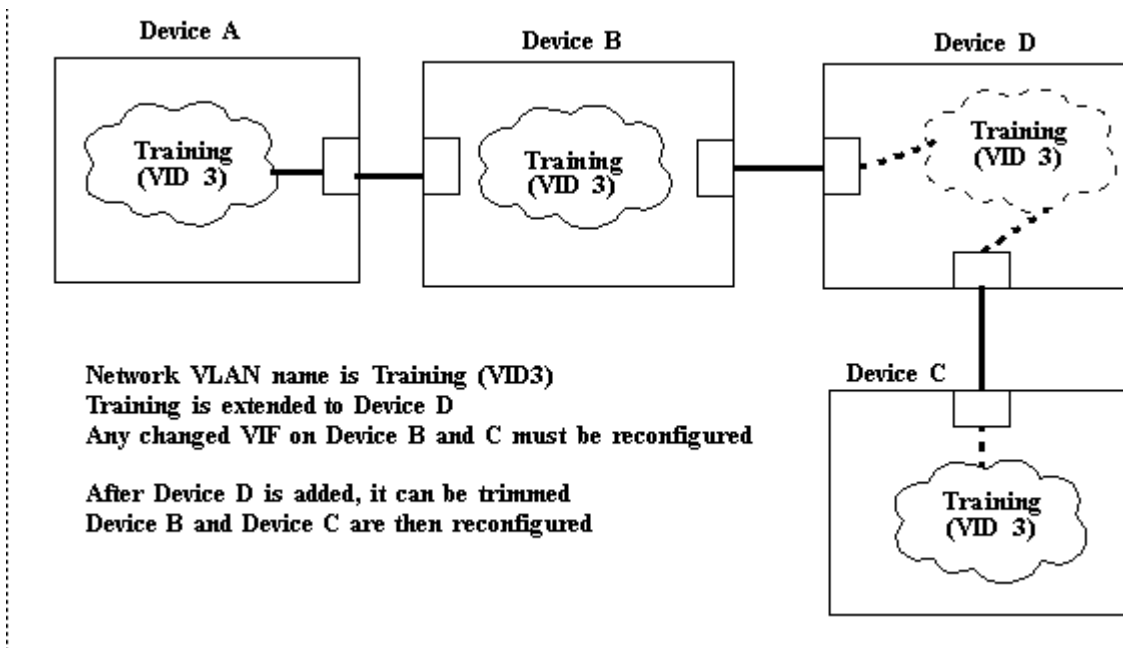

FIGURE 6-15 Extending a Network VLAN

The **Extend Network VLAN** form that appears when you select *Extend Vlan* from the pop-up menu is shown in Figure 6-16.

Extend Network Vlan Vlan[2]

Select Link

Extend Network Vlan from Node

Vlan Interface ID

Vlan Name Vlan ID

SubNet

Available Links - select one to continue

Link Name	From Ports	To Device	To Ports
Link#13	2	172.16.33.15	3

FIGURE 6-16 Extend Network VLAN Form (Physical Link)

This form shows Network VLAN Name, the VLAN ID (VID), and the available links from the device selected. (At this point a new physical link can be created between this device and the device that will include the Network VLAN. Refer to 6.2.4.)

Select **one** of the available physical links to activate the **Next** button. The form that shows the available VLAN IFs on this physical link is displayed, as shown in [Figure 6-17](#).

FIGURE 6-17 Extend Network VLAN Form (VLAN Interface) - File

Select one of the VLAN Interfaces. (At this point a new VLAN Interface can be created on the device.)

Select **one** of the available VLAN Interfaces to activate the **Next** button. The form that summarizes how the VLAN Network will be extended is displayed, as shown in [Figure 6-18](#).

FIGURE 6-18 Extend Network VLAN Form - Finish

The IP address and network mask can be entered in cells **IP Address** and **Network Mask** respectively by clicking the cell and entering the value.

Note: When you click the IP Address cell, the cell will be filled with the subnet address, and when you click the Network Mask cell (or any other cell), the cell will be filled with the network mask for the subnet.

Clicking **Finish** button will invoke the **Task Details** form and list the subtasks to be done. The Task Status field gives the state of the task, and if the Execution state is Failed, double-clicking the row will display the reasons for the failure in an Error Details pop-up.

6.5 Trimming or Splitting Network VLANs

A network VLAN can be trimmed or split as follows:

1. Open the submap for the VLAN and locate the link to be removed.
2. Right-click the link to be removed, and then select **Delete Vlan Link** from the pop-up menu. The dialog box shown in the following figure will appear. The dialog box shows the VID, node, and port that will be removed.

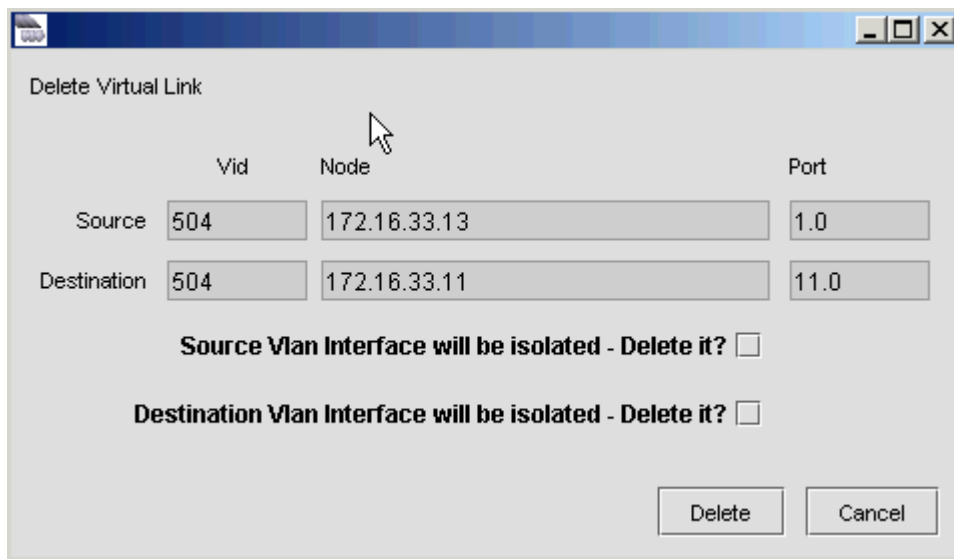

FIGURE 6-19 Delete Virtual Link Dialog Box

3. If the **Source Vlan Interface will be isolated - Delete it?** checkbox appears (as shown in Figure 6-19), checking this box will cause the source VLAN IF to be removed. If you want to remove the VLAN IF, check this box.
4. If the **Destination Vlan Interface will be isolated - Delete it?** checkbox appears, checking this box will cause the destination VLAN IF to be removed. If you want to remove the VLAN IF, check this box.
5. Click **Delete**. The View Task Details dialog box will appear.

6.6 Deleting Network VLANs

Deleting a Network VLAN can be done in the Physical Network or Network VLAN map. In the Physical Network map, select the **Network Services** pull-down, and then select **VLAN -> Delete VLAN**. In the Network VLAN map, select **VLAN Operations -> Delete VLAN**.

In either case, all available Network VLANs appear in the Delete Network VLAN form, as shown in Figure 6-20.

Delete Vlan

Delete Vlan

Contained Vlan Interfaces

Device	Vlan Name	Vlan ID	Vlan Type	IP Address	Network Mask	Tagged Ports	Untagged Po...
172.16.33.13	Vlan504	504	VLAN			1.0	None
172.16.33.11	Vlan504	504	VLAN			11.0	None

FIGURE 6-20 Delete Network VLANs Form

Select one of the VLAN IDs, and then click **Delete VLAN**. A form showing all the associated VLAN Interfaces that will also be deleted will appear. If this is what you wish to do, click **Finish**. The Task Details window then will appear.

Note: VLAN Interfaces with VID of 1, the default VLAN, will not be deleted.

6.7 Network VLAN Manager (Excluding EPSR)

6.7.1 Overview

The Network VLAN Manager/Analyzer includes the following functions:

- Shows in a hierarchy all the Network VLANs and their associated VLAN Interfaces.
- Shows in a hierarchy all the Device VLANs.
- Imports a spreadsheet of physical link attributes that automatically provisions the links and creates any associated Network VLANs.
- Displays VLAN outage statistics.
- Provides Port Management

Following is a description of these functions

Note: The functions of the Network VLAN Manager include all aspects of VLAN management, including configuring VLANs for Ethernet Protection Switching Ring (EPSR). All of these capabilities are explained here, with the exception of EPSR, which is explained in [6.13](#).

6.7.2 Create Network VLAN

When viewing the network VLANs, the user can select and then right-click the top node (Networked-VLAN Groups) and select Create New Networked VLAN. This is the same form as [Figure 6-9](#).

6.7.3 Using the Network VLAN Hierarchy

Viewing the Network VLAN Manager/Analyzer is done from the Physical Network map. From the Network Service menu, select **VLAN -> Network VLAN Manager**. The **Network VLAN Manager/Analyzer** form appears, as shown in the following figure. The **View Networked VLANs** view is selected.

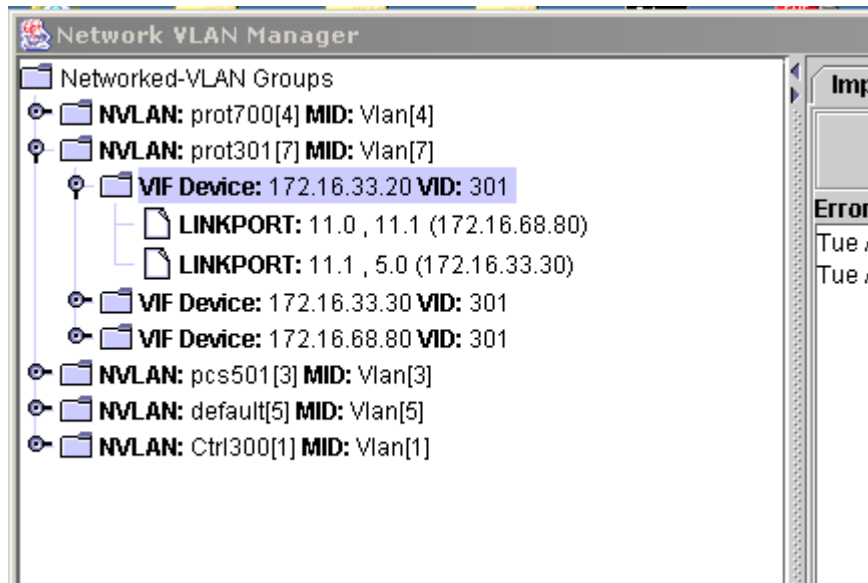

FIGURE 6-21 Network VLAN Manager/Analyzer Panel (Network VLAN Hierarchy)

All available Network VLANs are shown in a hierarchy.

Selecting and right clicking on the Network VLAN, VLAN Interface Device, or LINKPORT Node node allows the administrator to perform various tasks, listed in the following table.

TABLE 6-5 Network VLAN Functions on the Network VLAN Manager

Type of VLAN	Function	Description
Networked VLANs	Show Map...	Show the logical map for the network VLAN as a layered window in the NMS application.
	Show Detach Map...	Show a detached map, allowing it to be moved outside the NMS work area and closed separately.
	Delete Networked VLAN...	Brings up the Delete Networked VLAN form, the same as in 6.6.
	Resync VIFs with Device...	Query and re synchronize the VLANs and their associated ports on all the relevant devices
VIF Device	View VLAN Interface...	Brings up chassis view for the VLAN Interface chosen
	Extend VLAN...	Extends the chosen VLAN. Refer to 6.4
	Resync Device...	Query and re synchronize the VLANs and their associated ports on the selected device

TABLE 6-5 Network VLAN Functions on the Network VLAN Manager

Type of VLAN	Function	Description
LINKPORT	View Link Port	Brings up the Port Management Form.
	View Neighbor Link Port...	Brings up the port management form for the next port in the VLAN hierarchy in the left panel.
	Delete Logical Link	Brings up the Delete Virtual Link form, which deletes the VLAN path between two devices (not the physical link).
	Delete Assoc. Physical Link...	Deletes the physical link associated with the logical link. Note that if there are other logical links on the virtual link, the screen will not appear.

6.7.4 Using the Device VLAN Hierarchy

Selecting **View Device VLANs** in the lower right of the Network VLAN Manager brings up the Device hierarchy, as shown in the following figure:

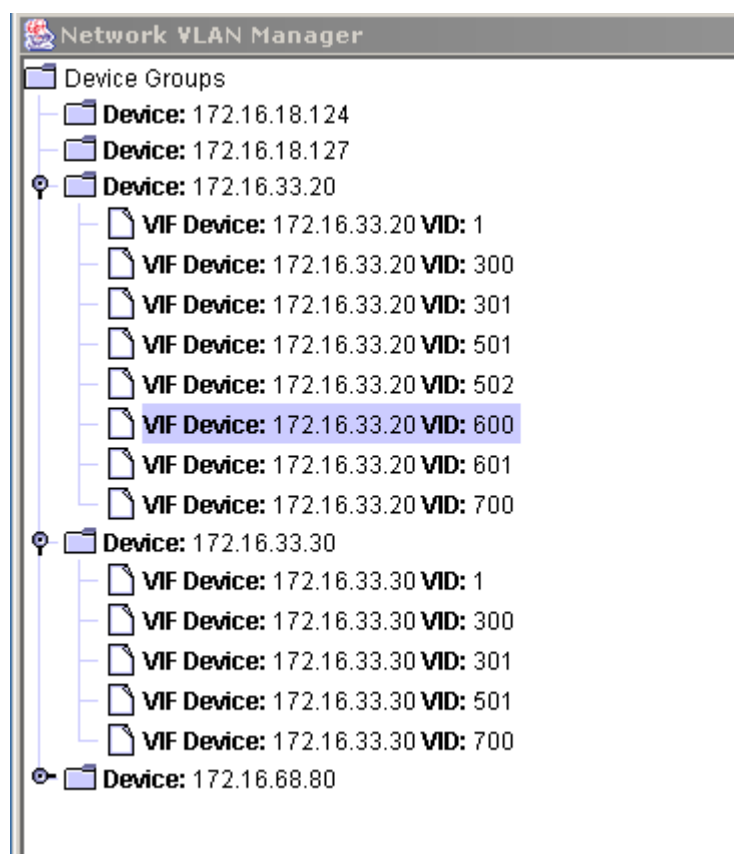

FIGURE 6-22 Network VLAN Manager (Device VLAN Hierarchy)

Right clicking on the Network VLAN, VIF Device, or LINKPORT Node node allows the administrator to perform various tasks, listed in the following table

TABLE 6-6 Device VLAN Functions on the Network VLAN Manager

Type of VLAN	Function	Description
VLAN Interface (VIF) Device	View VLAN Interface...	Brings up chassis view for the VLAN Interface chosen
	Extend VLAN...	Extends the chosen VLAN. Refer to 6.4
	Resync Device...	Query and re synchronize the VLANs and their associated ports on the selected device.

Note: The last selection, View Protection Domains, is covered in the EPSR subsection, [6.13](#).

6.7.5 Importing Physical Link Configurations

Since the physical link configuration for an existing network can be large and complex, the Network VLAN Manager can have an Excel spreadsheet of the physical links imported. This will populate the Physical Network map, and any existing Network VLANs that use those links will be configured.

Following are the rules for creating the link configuration file for this release:

- The file must be an Excel spreadsheet. (Future releases will support other filetypes.)

Note: When the AlliedView NMS is on a Sun platform, an Excel spreadsheet can still be imported, although it cannot be viewed by the user.

- The heading row must have the following columns:
 - **LinkName** - The name of the link (values are optional)
 - **Source Device** - A known device that the AlliedView NMS will have already discovered
 - **Source Port** - A valid port on the source device
 - **Destination Device** - A known device that the AlliedView NMS will have already discovered
 - **Destination Port** - A valid port on the desalination device
- The spreadsheet must reside in the following directory on the NMS:

```
<server path>\Allied Telesis\AlliedViewNMS\<NMS load>\state
```

[Figure 6-23](#) shows an example of an Excel spreadsheet.

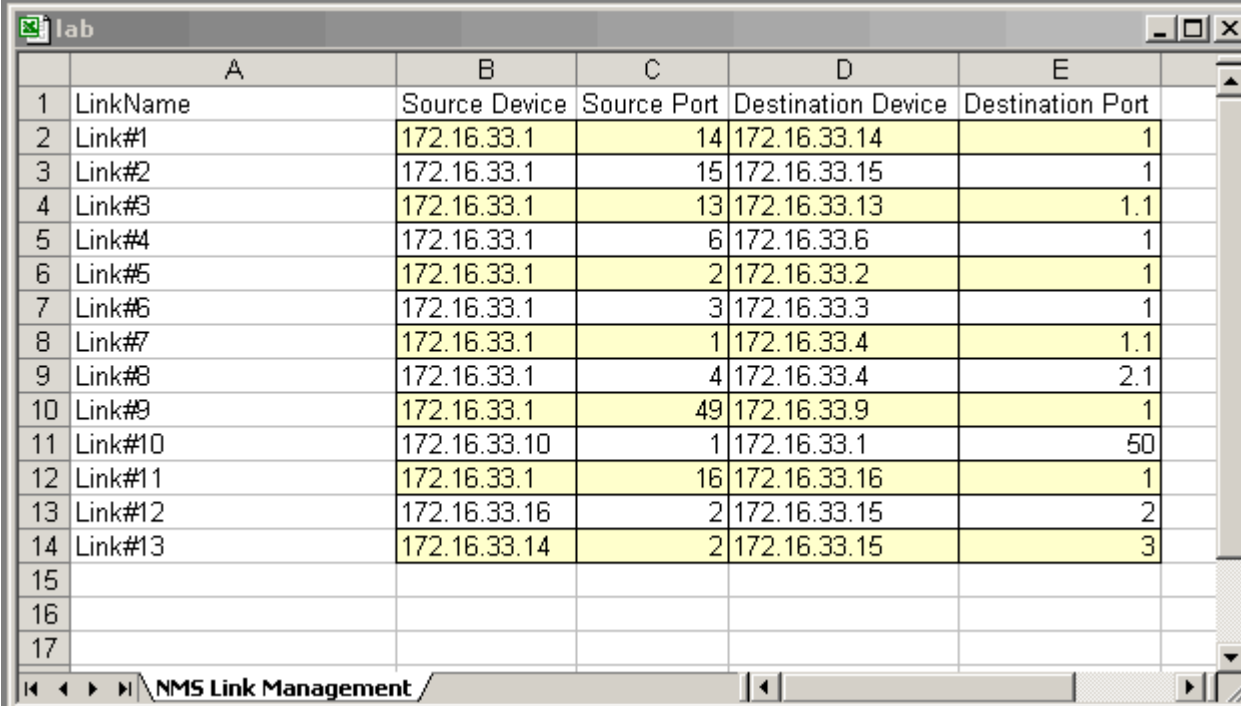

	A	B	C	D	E
1	LinkName	Source Device	Source Port	Destination Device	Destination Port
2	Link#1	172.16.33.1	14	172.16.33.14	1
3	Link#2	172.16.33.1	15	172.16.33.15	1
4	Link#3	172.16.33.1	13	172.16.33.13	1.1
5	Link#4	172.16.33.1	6	172.16.33.6	1
6	Link#5	172.16.33.1	2	172.16.33.2	1
7	Link#6	172.16.33.1	3	172.16.33.3	1
8	Link#7	172.16.33.1	1	172.16.33.4	1.1
9	Link#8	172.16.33.1	4	172.16.33.4	2.1
10	Link#9	172.16.33.1	49	172.16.33.9	1
11	Link#10	172.16.33.10	1	172.16.33.1	50
12	Link#11	172.16.33.1	16	172.16.33.16	1
13	Link#12	172.16.33.16	2	172.16.33.15	2
14	Link#13	172.16.33.14	2	172.16.33.15	3
15					
16					
17					

FIGURE 6-23 Example Physical Link Spreadsheet

To view the spreadsheet, open the file with Excel.

Note: The Excel file cannot be viewed on the Solaris platform.

To ensure that all files in the state directory are available, select Reload Profiles. To actually import the spreadsheet, select Import/Export. As the links are loaded, progress messages will appear, as shown in [Figure 6-24](#).

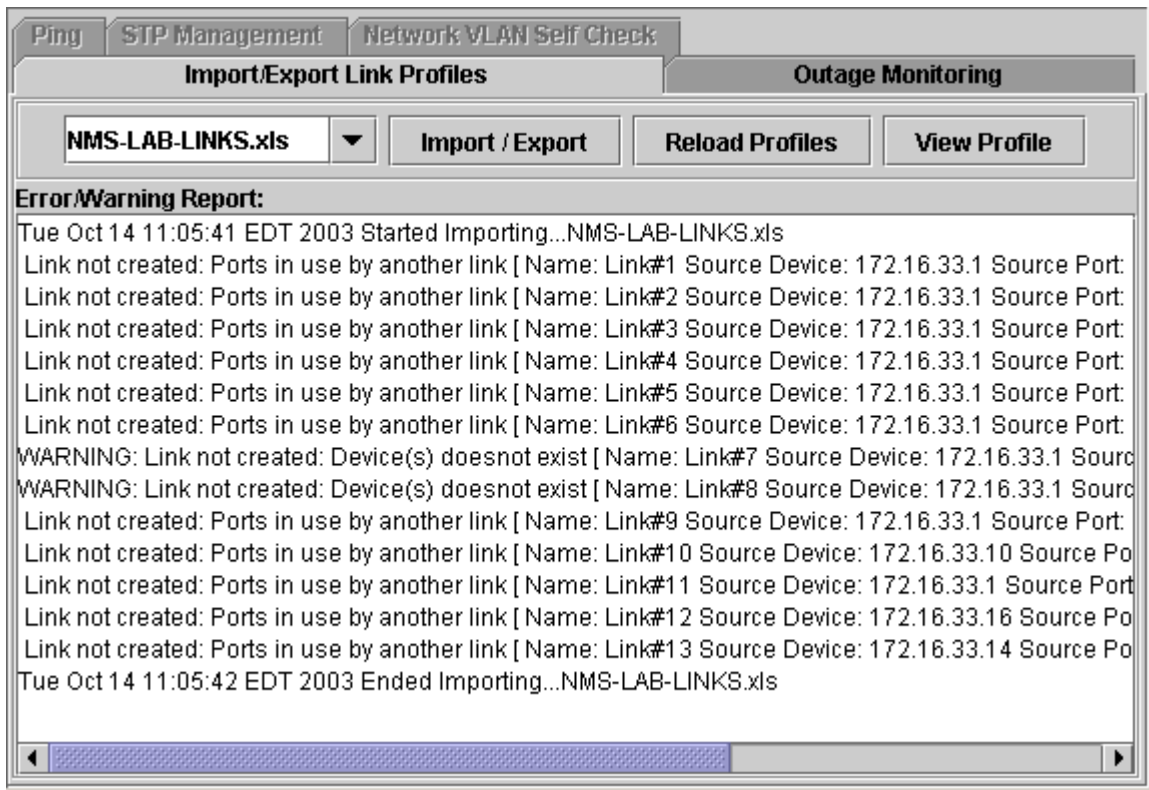

FIGURE 6-24 Error Messages When Importing Physical Links

Figure 6-24 shows an example of error messages, when the spreadsheet contains links that already physically exist.

6.7.6 Exporting Physical Link Configurations

The physical link configuration can be exported to an Excel file as well. If the user provides a file name that ends with **.xls** and if that file name is not associated with an existing profile, the AlliedView NMS will export the current NMS physical link data to the specified Excel file. This is shown in the following figure.

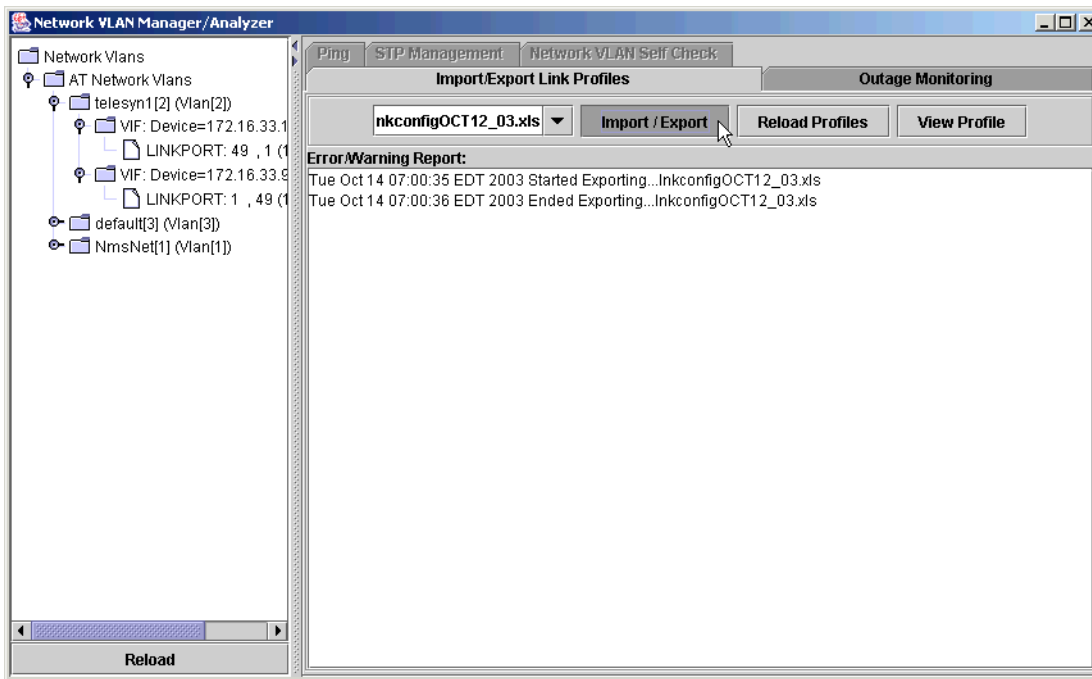

FIGURE 6-25 Exporting Link Configuration Data to an Excel File

If the user selects an existing profile or specifies the name of an existing profile, the data will be imported from the specified Excel file and not re-exported. Any existing links included in the file will be skipped.

6.7.7 Viewing VLAN Outage Statistics

The VLAN Outage Monitor provides long-term outage statistics on individual VLANs, which allows you to determine how your VLANs are performing over time. The VLAN Outage Monitor uses the Link Down trap to determine when an outage has occurred and the Link Up trap to determine when the outage is cleared. The statistics recorded by the VLAN Outage Monitor are stored in the NMS database and include:

- Network VLAN name – Name of the monitored Network VLAN
- Availability - The availability of the VLAN expressed as a value from 0 to 1 (0 percent availability to 100 percent availability)
- Outage Time – Approximate total outage time in days, hours, minutes, seconds, and milliseconds
- MTTR - Approximate mean time to repair in hours calculated as Total Down Time / Number of Failures
- MTBF - Approximate mean time between failures in hours calculated as Total Up Time / Number of Failures
- Number of Failures – Number of failures recorded
- Start Monitor Time – This is the time when the Network VLAN was first created or the last time when the monitoring was reset.
- Duration – The approximate elapsed time in hours between the Start Monitor Time and Current Monitor Time

The following figure demonstrates a typical monitoring timeline.

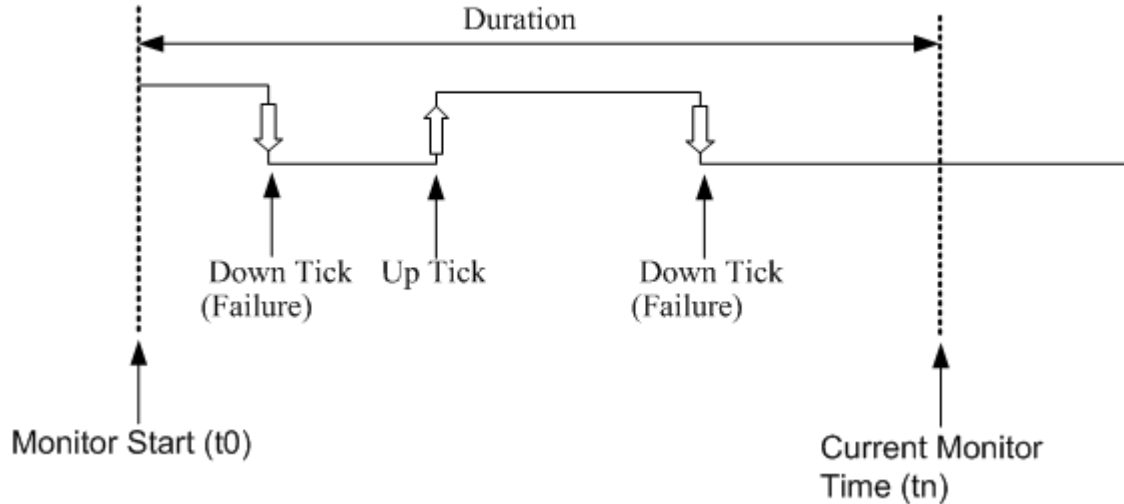

FIGURE 6-26 Sample VLAN Outage Monitoring Timeline

Note: For protection schemes, such as EPSR, when there is a break in the network VLAN topology due to link failure, an alternate path allows traffic to continue to run. As a result, these will not be recorded as outages and therefore will not appear for that networked VLAN. For more detail on EPSR, refer to 6.13.

The Outage Monitoring tab of the VLAN Manager is shown in the following figure.

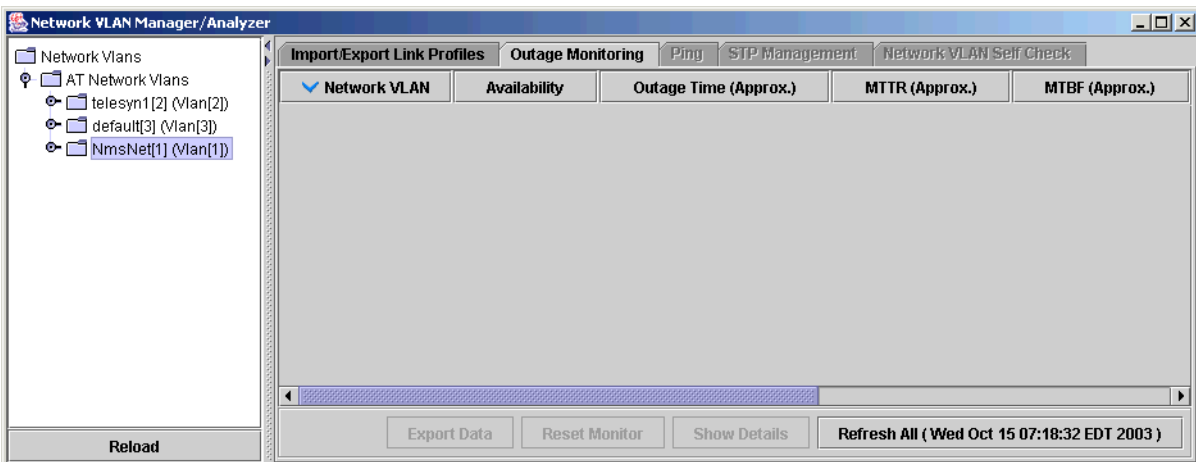

FIGURE 6-27 VLAN Manager Outage Monitoring Tab

6.7.7.1 Viewing Details

To see the VLAN outage details, select a VLAN in the list, and then click **Show Details**. The Network Vlan Outage Details window, shown in the following figure, is displayed.

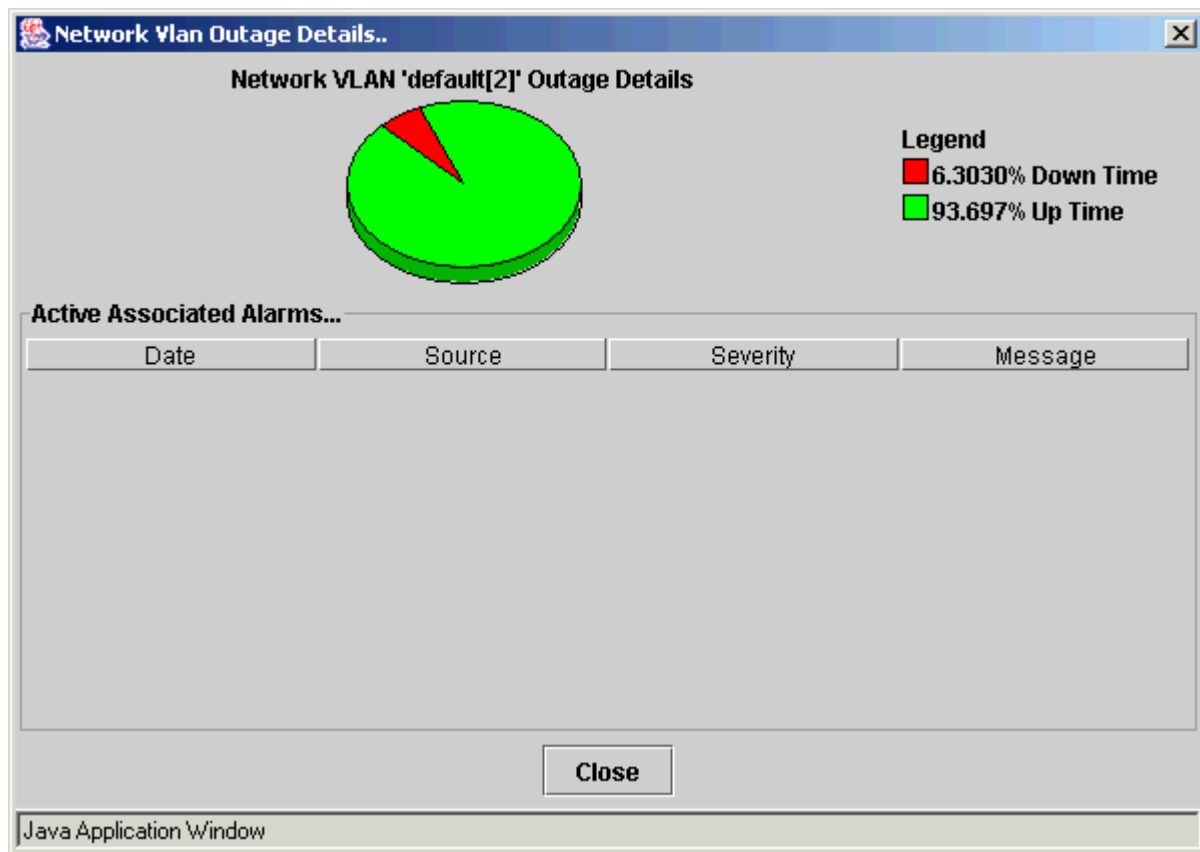

FIGURE 6-28 Network Vlan Outage Details Window

6.7.7.2 Resetting Monitor Time

To reset the monitor time (i.e. set the monitor start time to the current monitor time), select a VLAN from the list, and then click **Reset Monitor**.

6.7.7.3 Refreshing all Network VLANs

To refresh all of the VLANs in the list, click **Refresh All**.

6.7.7.4 Exporting Outage Data

To export outage data to a file, select the records you wish to export, and then click **Export Data**. Specify the destination as a file or a printer.

6.8 Example of Creating Network VLANs

To show how all of these maps and forms work together when creating a Network VLAN, a sample IP-based and a sample island-based Network VLAN are created in this subsection.

6.8.1 Sample Island-Based Network VLAN

Figure 6-29 includes an iMAP 9400, an iMAP 9700, and a Rapiier 48i. The values seen in this figure will be reflected in the sample steps.

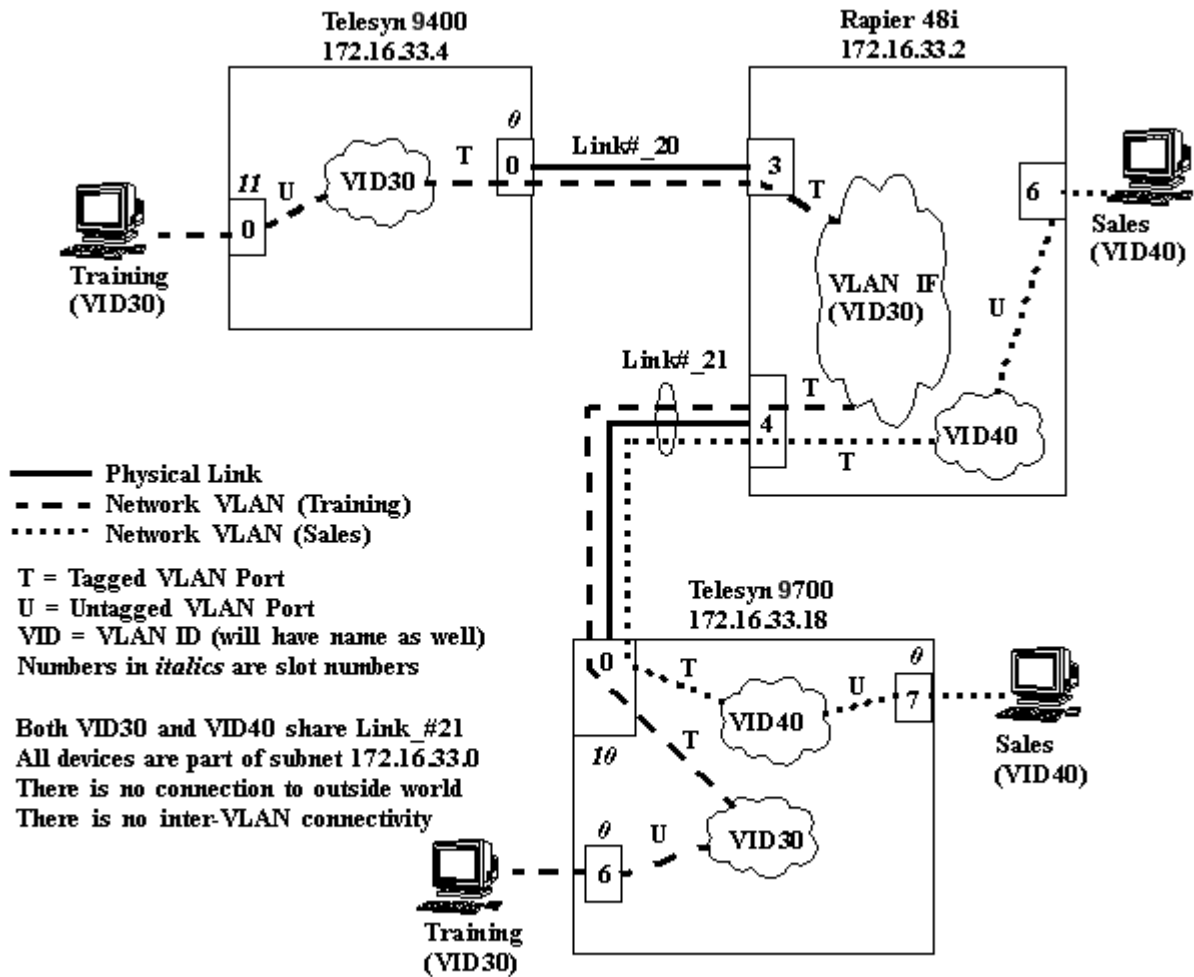

FIGURE 6-29 Sample Island-Based VLAN Networks

Figure 6-30 shows the three devices on the physical network map. Note that the Rapier 48i already has a physical link to another device.

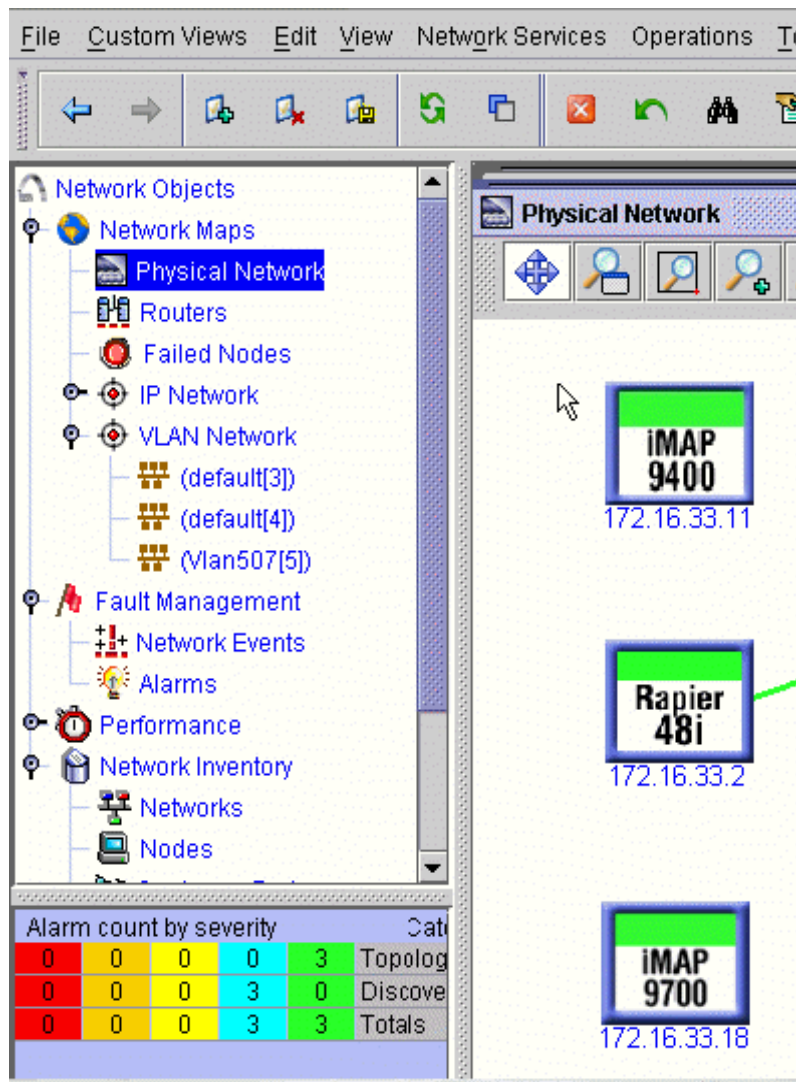

FIGURE 6-30 Three Devices Included in the Island-Based VLAN

To create the physical links, select and Shift-select to include all three devices, and then right-click to select *Network Service* - > *Link Operation*. The **Layer 2 Links** form appears. Select Add Link, and then select the link name, device number, and port number to configure the example. Figure 6-31 shows Link_#20 being configured.

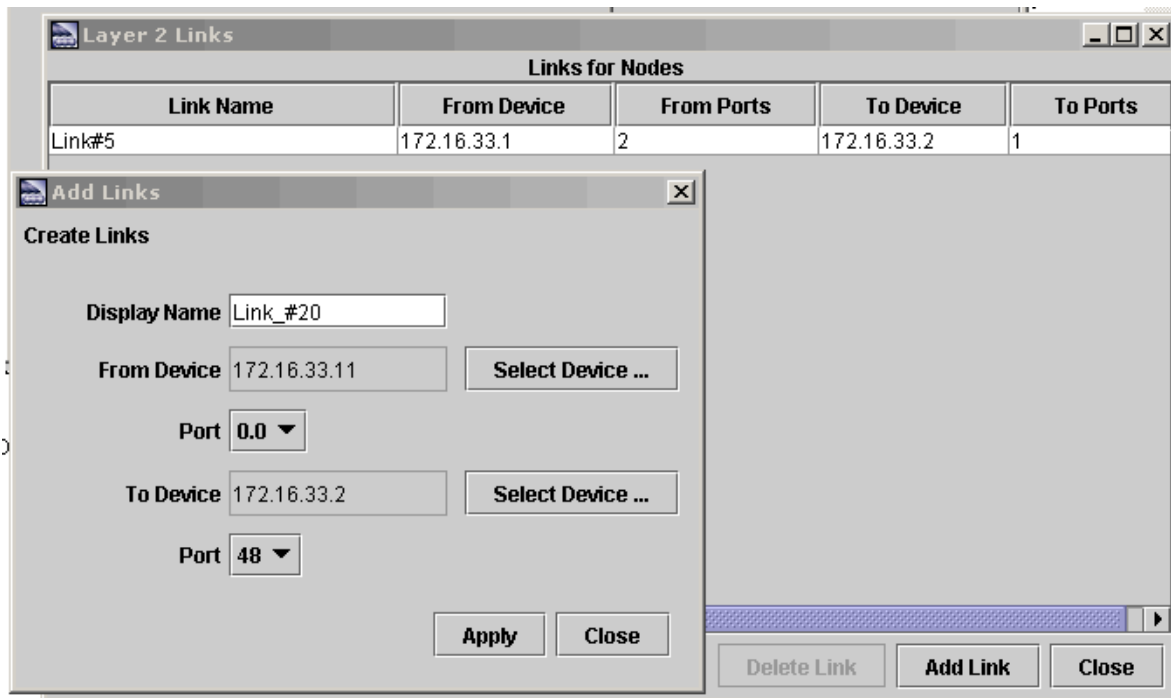
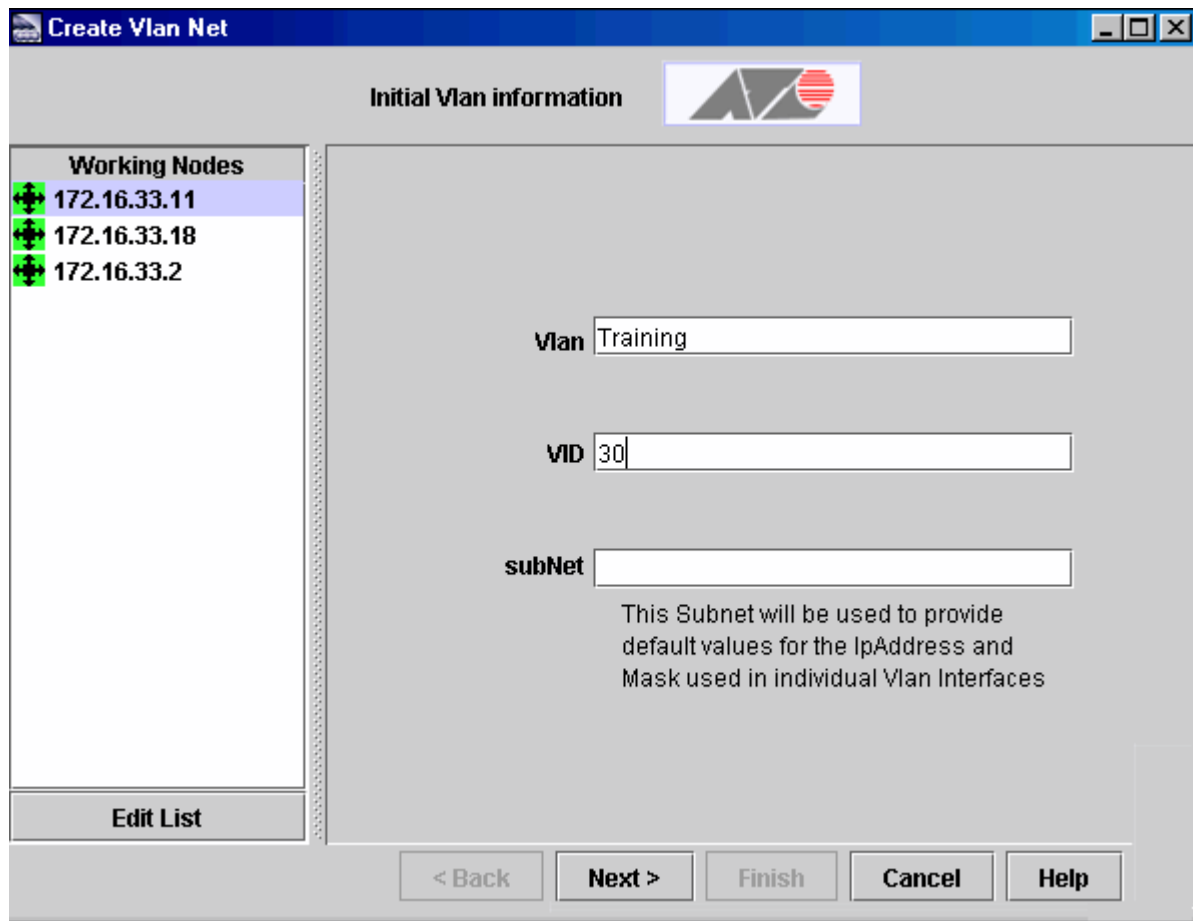

FIGURE 6-31 Creating a Physical Link

Once the two physical links (Link_#20 and Link_#21) are created in the AlliedView NMS, the Network VLANs that will use the links (Training and Sales) can be created.

Still on the Physical Network map, Select and shift-select the three devices, and then right-click *Network Services* -> *VLAN* -> *Create VLAN*. The Create VLAN form will appear. Fill in the fields for the Training VLAN, as shown in [Figure 6-32](#).



The screenshot shows a window titled "Create Vlan Net" with a sub-header "Initial Vlan information". On the left, a list titled "Working Nodes" contains three entries: "172.16.33.11", "172.16.33.18", and "172.16.33.2", each with a green plus icon. Below the list is an "Edit List" button. The main area contains three input fields: "Vlan" with the value "Training", "VID" with the value "30", and "subNet" which is empty. Below the "subNet" field is a note: "This Subnet will be used to provide default values for the IpAddress and Mask used in individual Vlan Interfaces". At the bottom, there are five buttons: "< Back", "Next >", "Finish", "Cancel", and "Help".

FIGURE 6-32 Sample Values for the Training Network VLAN

Click **Next**, and the **Modify Links** form appears. Check the checkbox for Link_#20 and Link_#21 from 172.16.33.2. Do not select Link#5, since that is not part of this Network VLAN. [Figure 6-33](#) shows Link_#21 about to be added.

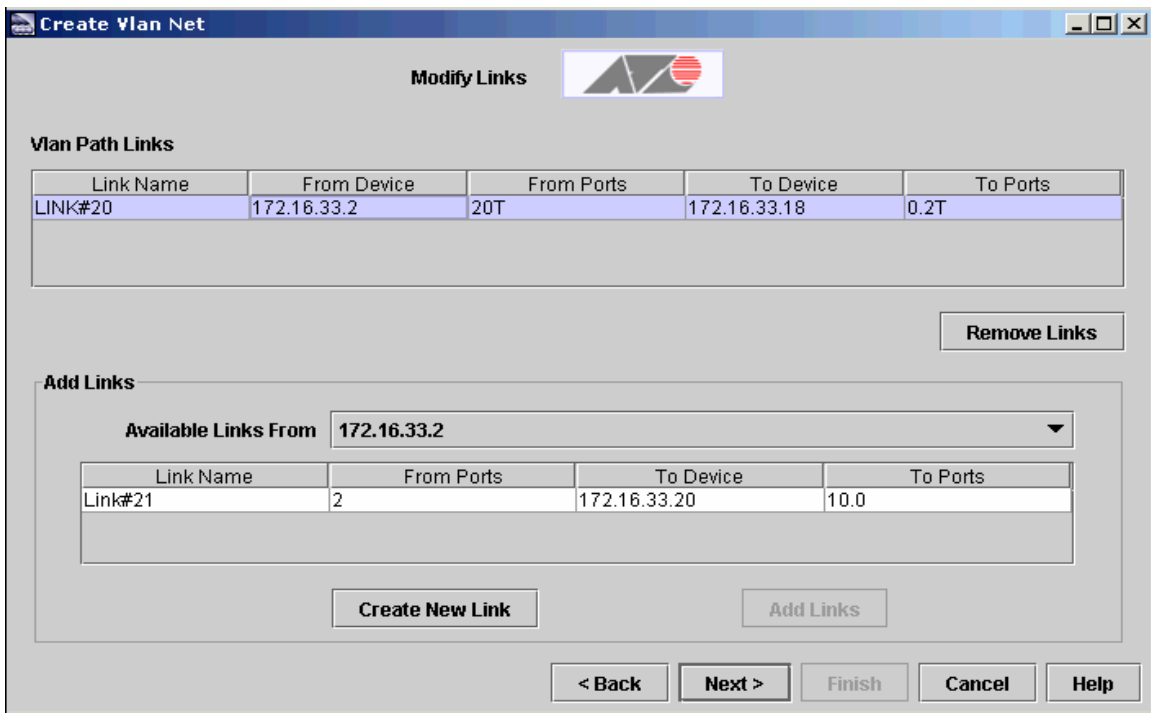

FIGURE 6-33 Adding Link_#20 and Link_21 to the Network VLAN

After adding the relevant physical links, click **Next**. The **Configure Vlan Interfaces** form appears, and shows the VLAN interfaces over the physical links.

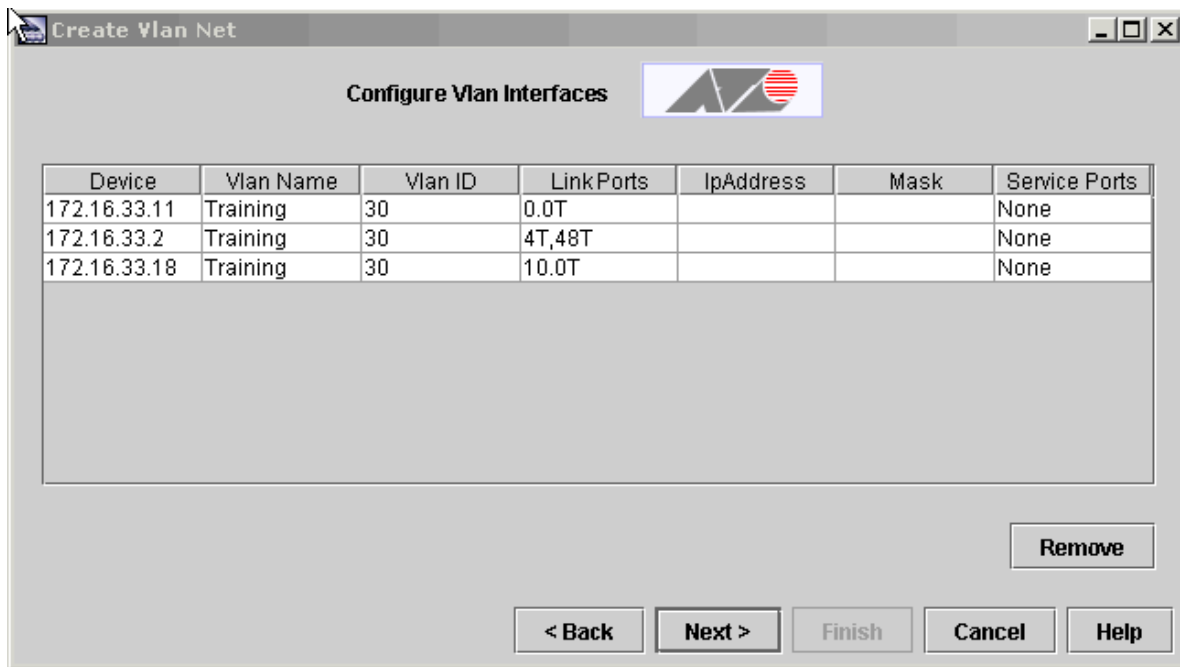

FIGURE 6-34 Configure Service Ports in Sample Island-Based VLAN

On the **Configure Vlan Interfaces** form, add the service ports (ports that connect to devices that are part of the Training Network VLAN) by clicking in the Service Ports column cell for devices 172.16.33.11 and 172.16.33.18, since these will be

the devices that have service ports. In the example the service ports would be 11.0 Untagged for 172.16.33.11 and 0.6 Untagged for 172.16.33.18.

Click **Next**, and the **Test Network VLAN** form appears. This will test the connectivity between all three devices. Click **Finish** and the **Task Details** form will show the tests and if they are successful, as shown in [Figure 6-35](#).

To add the island-based Network VLAN for Sales, the same steps would be followed that would match [Figure 6-29](#).

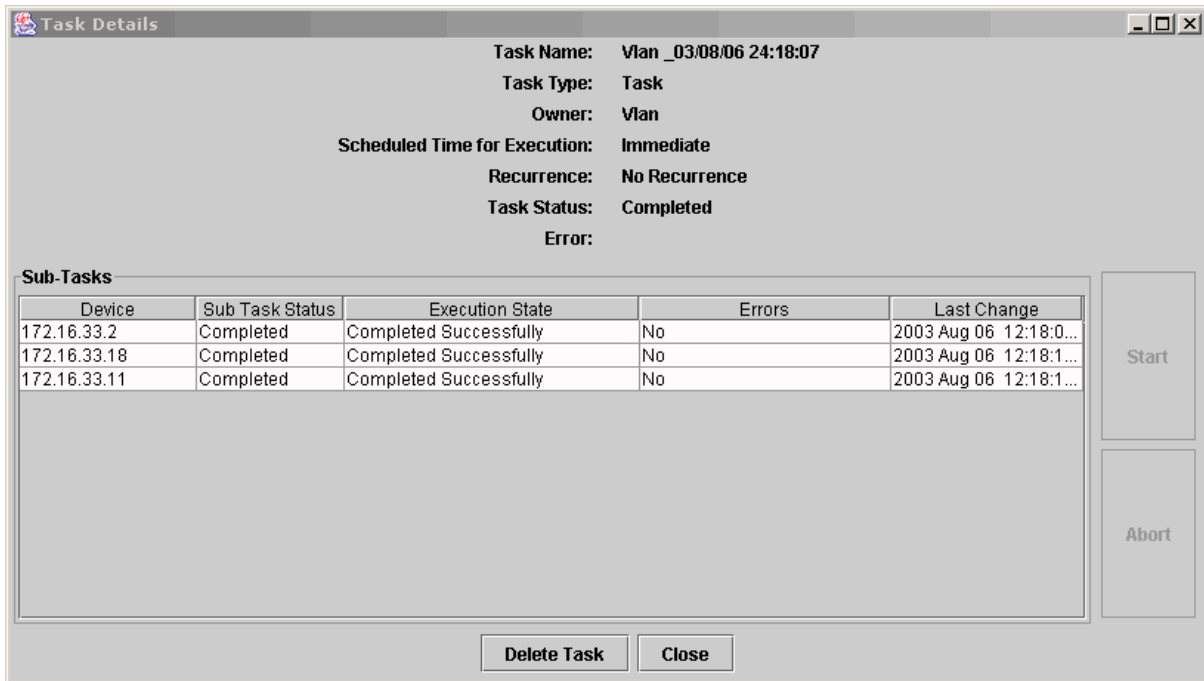

FIGURE 6-35 Sample Island-Based VLAN Successfully Tested

6.8.2 Extending the Island-Based VLAN

To extend the Network VLAN Training (VID=30), a device (172.16.32.13) will be added to 172.16.32.18, so another physical link will be required between them. A service port will then be added to .18.

First, create a new physical connection. Select (shift-click) both devices, and then select *Network Services -> Link Operations* to invoke the **Layer 2 Links** form. Click **Add Links**, and then choose from among the available links, as shown in [Figure 6-36](#).

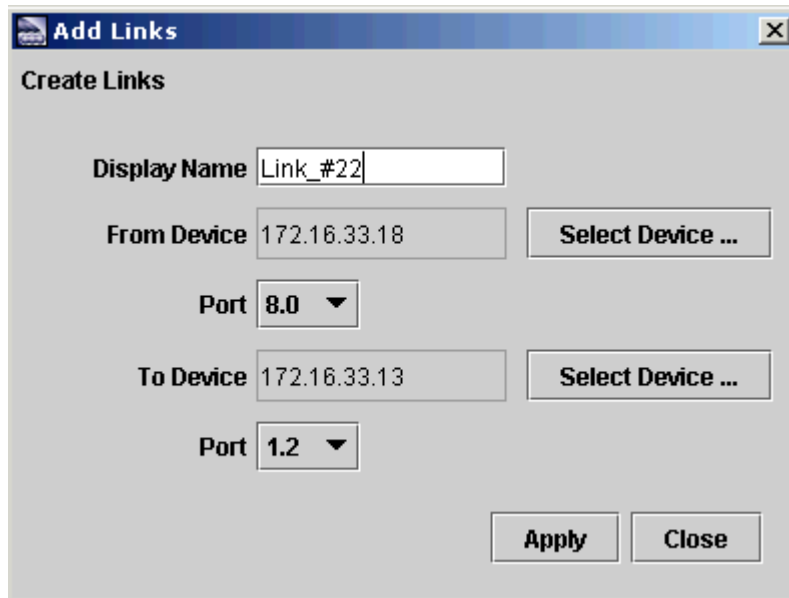

FIGURE 6-36 Adding a Physical link to Extend a Network VLAN

Now that the physical link is created, go to the Training VLAN in the VLAN Network map, Right-click on the device in the Network VLAN that has the new link (172.16.33.18) and select *Extend VLAN*. The **Extend Network VLAN** form appears, which includes the new physical link, as shown in Figure 6-37. Note that you could create the new physical link here is desired.

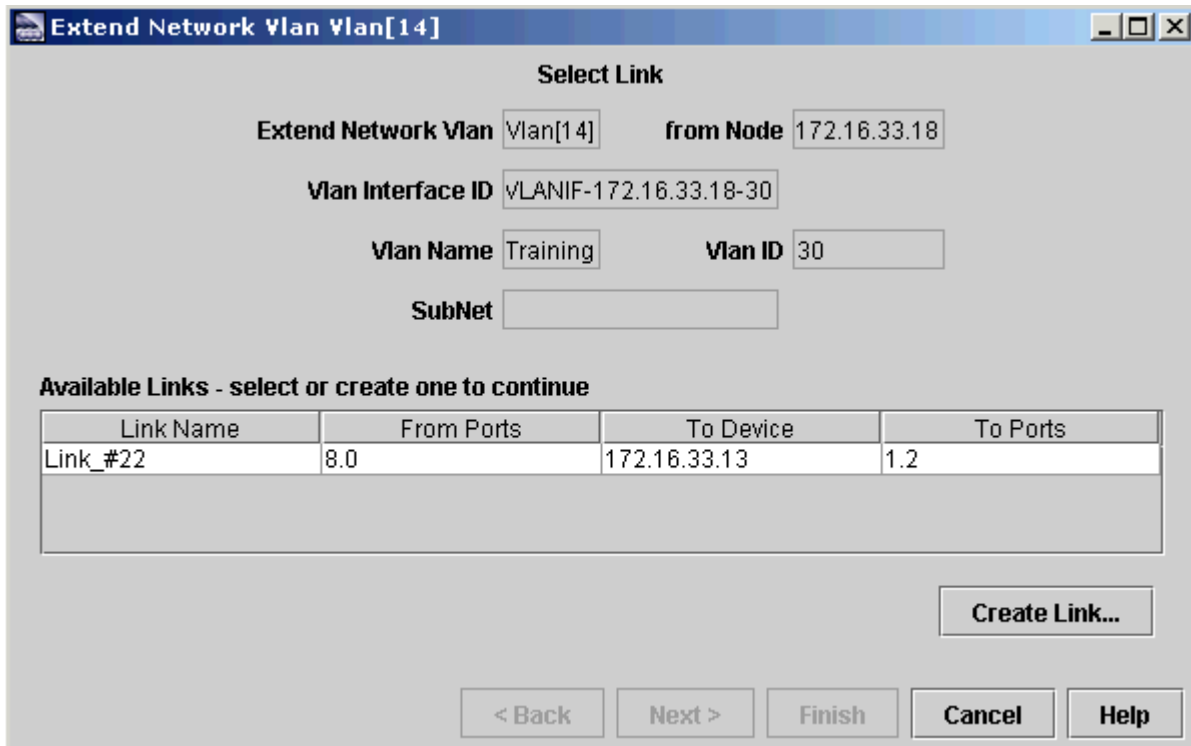

FIGURE 6-37 Selecting a Link for Extending a VLAN

Select the link and click **Next**. The **Select/Create VLAN Interface** form appears. Since the Training VLAN is not yet created on the .13 device, click **Create VIF**. The **Create New VLAN** form appears, with the Training VLAN with the VLAN ID of 30 already filled in. Click **OK** and the VLAN Interface will be added, as shown in [Figure 6-38](#).

Select/Create Vlan Interface

Extend Network Vlan from Node

Vlan Interface ID

Vlan Name Vlan ID

SubNet

Extend to Node

Existing Vlan Interfaces - select or create one to continue

Vlan Name	Vlan ID	IP Address	Network Mask	Network Vlan	Tagged Ports	Untagged Ports
Training	30					

FIGURE 6-38 Creating the VLAN IF on the extended Network VLAN Device

Select the row and click **Next**. The **VLAN Operations** form appears and shows what will be done to finish extending the Network VLAN. Click **Finish** and the **Task Details** window will perform the operations and give the results.

With the Training Network VLAN now extended, VLAN interfaces on the .13 device can be added that use the Training Network VLAN.

To trim the network VLAN, perform these steps:

1. Go to the specific Network VLAN map. Right-click the device that will no longer have a VLAN IF and select **Configure VLAN Interface**.
2. Select the Training Network VLAN from the pull-down menu, and then put all the tagged and untagged ports back to blank (neither T nor U). Click **Apply**.
3. If any physical links need to be reconfigured since a device is no longer part of this Network VLAN, go to the Physical Network map and delete/add/change links to match the trimmed configuration.

Vlan Operations

Extend Network Vlan from Node

Vlan Interface ID

Vlan Name Vlan ID

SubNet

These operations will be performed

Operation	Device	Vlan Name	Vlan ID	IP Address	Network ...	Tagged ...	Untagge...
UPDATE	172.16.33.18	Training	30			8.0,10.0	0.6
CREATE	172.16.33.13	Training	30			1.2	

< Back Next > Finish Cancel Help

FIGURE 6-39 Updating the VLAN IF on the Extended Network VLAN Device

6.9 Example Configurations for HVLAN, Translations

6.9.1 Overview

Note: The Port-based HVLAN and translation feature are not compatible on the same port. Once a port is configured with the HVLAN option, it cannot use the translation feature, and vice-versa. This applies to the cards that support both of these features (GE3, XE1, GE8).

6.9.2 HVLAN Configuration

Figure 6-40 includes an iMAP 9400, an iMAP 9700, and a Rapier G6. The values seen in this figure will be reflected in the sample steps.

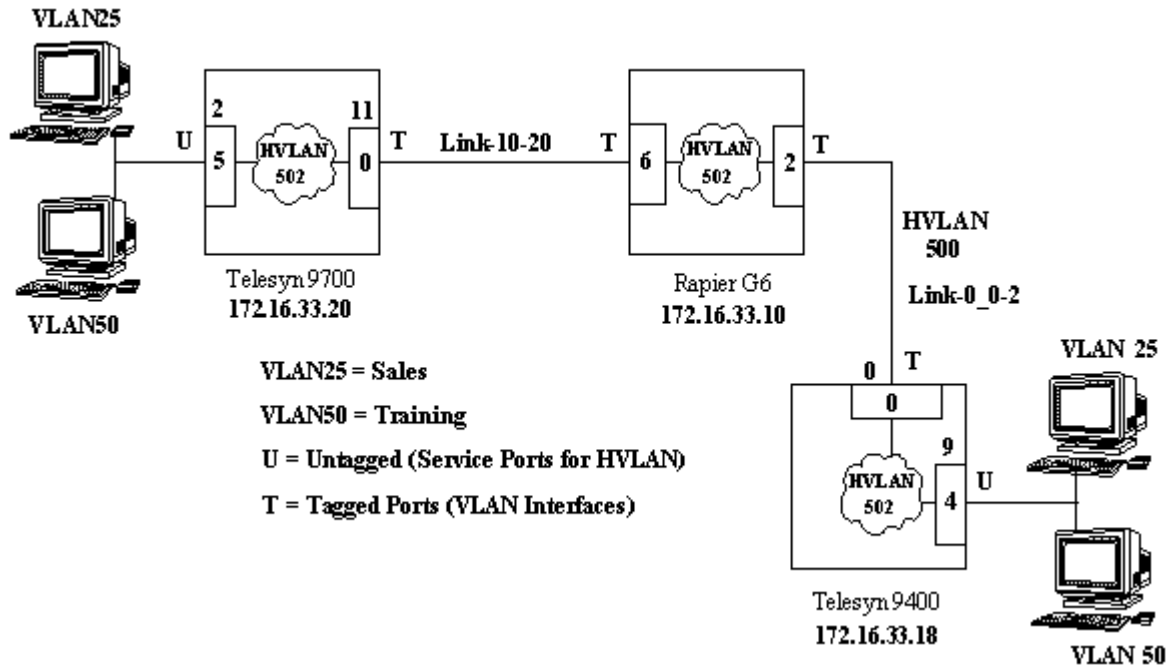

FIGURE 6-40 Example HVLAN Configuration

This example assumes the physical links (Link-10-20 and Link-0_0-2) have already been created, as explained in 6.2.4. On the Physical Network map, Select and shift-select the three devices, and then right-click *Network Services* -> *VLAN* -> *Create VLAN*. The Create VLAN form will appear (Initial VLAN Information). Fill in the fields for the VID502, as shown in Figure 6-41.

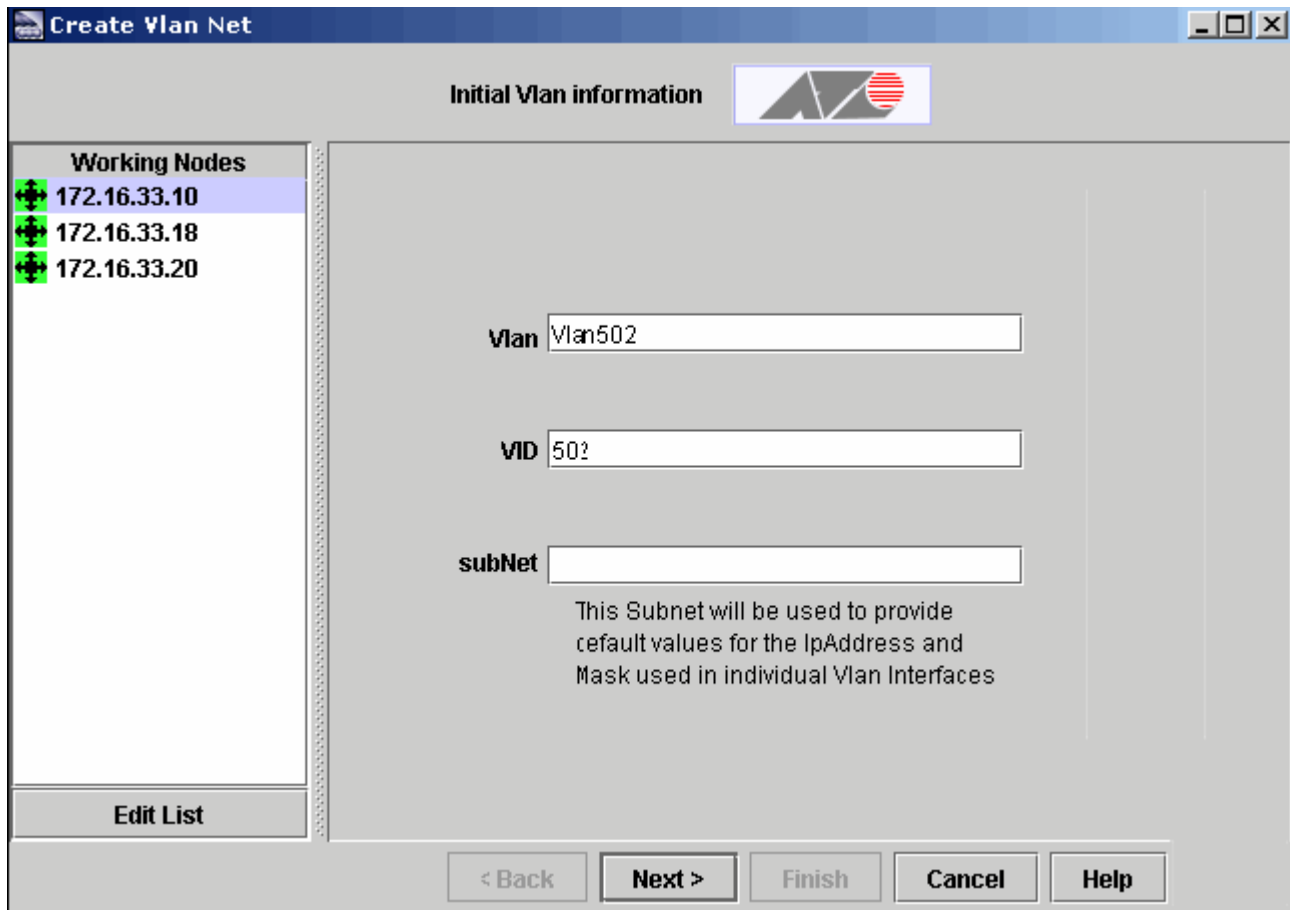

FIGURE 6-41 Create VLAN for HVLAN Configuration

Clicking on Next brings up the Modify Links Form, where the user selects a device from the Available Links Form pull-down, and then adds the appropriate link, as shown in [Figure 6-42](#).

Create Vlan Net

Modify Links

Vlan Path Links

Link Name	From Device	From Ports	To Device	To Ports
Link-10-20	172.16.33.10	6T	172.16.33.20	11.0T
Link-0_0-2	172.16.33.18	0.0T	172.16.33.10	2T

Add Links

Available Links From: 172.16.33.10

Link Name	From Ports	To Device	To Ports
Link-1-10	1	172.16.33.1	50

< Back **Next >** Finish Cancel Help

FIGURE 6-42 Selecting Links and Adding to the HVLAN Configuration

Clicking **Next** brings up the **Configure VLAN Interfaces Form**, as shown in [Figure 6-43](#). For the iMAP 9000 devices, the type must be changed to HVLAN, which the figure illustrates.

At this point the user can click on the Service Ports column and select which ports will included.

Note: Service ports that are part of an HVLAN configuration have restrictions, since they must be untagged. Moreover, once a port is a member of any other VLAN (except 1), it cannot be added to the HVLAN configuration.

Device	Vlan Name	Vlan ID	Vlan Type	Link Ports	IpAddress	Mask
172.16.33.10	Vlan502	502	VLAN	2T,6T		
172.16.33.20	HVlan502	502	HVLAN	11.0T		
172.16.33.18	HVlan502	502	HVLAN	0.0T		

FIGURE 6-43 Configure Vlan Interfaces Form (iMAP 9000 Devices are Type HVLAN)

Now that the Vlan Interfaces are configured, it can be tested. Clicking on **Next** brings up the Test Network Vlan form, (Figure 6-44), and then clicking on **Finish** runs the test and provides the results, as shown in Figure 6-45.

If a test does not succeed, an error window appears with a message as to why the test failed.

Test Network Vlan

Operations

Device	Vlan Name	Vlan ID	Vlan Type	Sub-Net	Tagged Ports	Untagged Po...	State
172.16.33.10	Vlan502	502	VLAN		2,6	None	New
172.16.33.20	HVlan502	502	HVLAN		11.0	None	New
172.16.33.18	HVlan502	502	HVLAN		0.0	None	New

Problems

Num	VIF	Description	Ignore

< Back Next > Finish Cancel Help

FIGURE 6-44 Test Network VLAN Form (Finish to run Test)

Task Details

Task Name: Vlan_04/02/14 20:50:01
 Task Type: Task
 Owner: root
 Scheduled Time for Execution: Immediate
 Recurrence: No Recurrence
 Task Status: Completed
 Error:

Sub-Tasks

Device	Sub Task Status	Execution State	Errors	Last Change
172.16.33.18	Completed	Completed Successfully	No	2004 Feb 14 08:50:0...
172.16.33.20	Completed	Completed Successfully	No	2004 Feb 14 08:50:1...
172.16.33.10	Completed	Completed Successfully	No	2004 Feb 14 08:50:0...

Start Abort

Delete Task Close

FIGURE 6-45 Testing Results for the HVLAN Configuration

Extending this HVLAN configuration usually involves adding another iMAP 9000 device with service ports that support multiple VLANs on its untagged ports. The steps are similar to the steps in 6.8.2, where the user usually creates a link to another device from the VLAN Network node (in the example this would be the **VLAN502[51]** node). The user then right-clicks on the device in the VLAN that has the new link and selects **Extend VLAN**. The link would be selected.

Clicking on **Next** would bring up the **Select/Create Vlan Interface Form**, and the user would select the **Create VIF** button. The VlanID (502) would be given the type HVLAN. After pressing OK, the form would have the new HVLAN502 added to

the list. The user would then select this Vlan and select **Next**. The **Vlan Operations Form** appears with the CREATE operation for the HVLAN502. Selecting **Finish** will run the tests to check if the configuration is valid.

6.9.3 VLAN Translations Configuration

6.9.3.1 Setting up VLAN Translations

To set up VLAN translations, the basic sequence is:

1. Create the VLAN that will become the translated VLAN that will go through the network.
2. Associate this translated VLAN with the appropriate interfaces, both on the customer side (where the translation will take place), and the network side (as the translated VLAN goes through the network).
3. Set the translated VLAN option, as shown in the following figure.

The screenshot shows the 'Create Profile' configuration window. The 'Profile Name' field is empty, and the 'Profile Type' is 'Etherlike Port'. The 'Profile Attributes' section is active, with the 'Common' tab selected. The 'Attribute New Value' section contains the following settings:

- Profile Scoping: None
- Speed: Autonegotiate
- Duplex: Autonegotiate
- Flow Control: Off
- Max. # of Learned MAC Addr. (None or 0..256): None
- Include VLAN Configuration in Profile: True
- Untagged VLAN (1..4094 or None): 1
- Tagged VLANs (comma separated list or None): 20=201,40=901,10
- QOS Policy: networkport (Telesyn)

A large white arrow points from the text 'Translations' to the 'Tagged VLANs' field. At the bottom of the window, there is a 'Copy values from profile:' dropdown menu set to 'A101 GbE UpLink' and a 'Copy' button. Below this are 'Create', 'Cancel', and 'Help' buttons.

FIGURE 6-46 Port Profile with Translations Options

The values entered are 20=201, 40=901, 10 (This would be an example for an iMG6x6MOD).

6.9.3.2 Restrictions

Keep the following configuration guidelines in mind when provisioning Translation VLANs:

Note: For more details on the VLAN Translations feature, refer to the Feature Guide.

- The following cards support VLAN translation:
 - GE3, XE1, GE8 (network interfaces) Refer below for FE10/FX10/FX20.

- ADSL24A/B, SHDSL24, ADSL24SA, ADSL24AE, NTE8, VDSL24A/B, ADSL48A/B (customer interfaces)
- The following cards do **not** support VLAN translation:
 - CES8
- The Port-based HVLAN and translation feature are not compatible on the same port. Once a port is configured with the HVLAN option, it cannot use the translation feature, and vice-versa. This applies to the cards that support both of these features (GE3, XE1, GE8).
- The FE/FX10 does not support both translated and non-translated VLANs on the same port in order to avoid the mixing of a non-translated VLAN traffic onto translated VLAN traffic (which is undesirable) and as such will drop non-translated VLANs. The other card types that support translation do not drop non-translated traffic. Users should be careful in their network design to ensure this.

6.10 Profile Management

In the AlliedView NMS, a profile is a set of configuration parameters that is given a unique name. This profile can then be applied to an object (device or port) in the network.

Note: The interactions between device-based and network-based Profiles are explained in Section [6.10.11](#).

The following subsections explain Profile Management as follows:

- Profile Configuration - The creation, modification, and deletion of the profiles on the NMS.
- Profile Deployment - The application of the profiles defined in NMS to selected objects (devices or ports) in the network.
- Profile Monitoring - The monitoring of the devices and ports in the network to keep the NMS user informed as to which devices or ports are using which profiles, and whether the configuration of the devices or ports continues to match the Profile that was applied to it.

6.10.1 Profile Configuration Parameters - Devices and Scoping

6.10.1.1 Devices

There are many different types of devices and ports in the network and each type has a different set of parameters associated with it. Profile Management supports the following:

- Device profiles:
 - iMAP and SBx3112
 - Rapier
 - SwitchBlade/9800
 - AT8900
 - AlliedWare Plus
 - x200
 - x210
- Card profiles:
 - MGCP
 - SIP
- Port profiles:
 - Ethernet (Ether-like) Port
 - Etherlike-DS3
 - ADSL
 - ADSL-BOND
 - SHDSL Port
 - VDSL Port
 - POTS Port
 - CES-DS1 Port
 - CES-E1 Port
 - NTE-DS1 Port
 - NTE-E1 Port
 - EPON
 - ONU
- iMG/RG (Note that these are not available on the EE version, refer to 6.10.17.)
 - General
 - Internet
 - Video
 - Voice
 - CES
 - CES_DS1/CES_E1

Note: A description of the RG Profile types is included in a section devoted entirely to RG provisioning, Section 7.

Note: For profiles for EPON interfaces and their QoS policies, refer to 6.11.11. Note that the iMAP_EPON device class in QoS policies/actions is an 'exclusive' device class; a policy or flow cannot be used with any other device-class once assigned to the iMAP_EPON device class.

- Note:** For the ADSL port profile the user can specify for a service VLAN the VC (0-3) as well as the VPI, VCI, and framing.
- Note:** The ADSL-Bond profile is used to support the G.bond (ITU G.998) for ADSL interfaces. It includes references to a primary and secondary ADSL port profile. Refer to 6.10.12.
- Note:** Port Direction is available for the port profile for ether-like ports. Using the port profile, you can set the port direction on all ether-like cards, including the GE24POE. The setting can also be changed from the Service Management Form. For information on the devices where this changing of port direction occurs and cautions, refer to 7.9.5 for iMG7x6MOD and 6.10.2.3 for GE24POE.
- Note:** Related to the previous Note, with the provisioning of iMG devices with 1G WAN ports, the default for the Etherlike port Profile includes the field Direction (either Network or Customer). Moreover, the default for this field is changed to Customer (rather than the implicit Network). As a result new port profiles should be created with the port direction set to match the provisioning scenario in which they will be used. Otherwise, there will be an error when trying to deploy the profile. For example, with the XE6 card, if the Direction is not explicitly set to Network, you will get the error message "Invalid provisioning value."
- Note:** For existing Ethernet port profiles these changes are not an issue, because they will not have the port direction field explicitly set. However, new port profiles should be created with the port direction set to match the provisioning scenario in which they will be used, as follows:
- Note:** For Etherlike, ADSL, SHDSL, and VDSL ports, the user can include the STP and BPDU Cop attributes. These are included in a separate STP tab for the profiles. For information on STP parameters and the BPDU Cop feature, refer to the iMAP documentation.

Following are the device level parameters associated with the profile types.

- Rapier
 - HWPRIORITY (Priority to COS Queue mapping)
 - MAXPACKETS, MAXLATENCY
- SwitchBlade 9800
 - PRIORITYQUEUEING (enable/disable and setting to QOS or VLANPRIORITY)
 - HWSCHEDULER (STRICT, LOWERPRIORITY, or INTERNALMEM)
 - VLANQUEUEMAP (Priority to COS Queue mapping)
 - VLAN Tag User Priority Mapping (Enable/disable)
 - VLANREMAP (Input priority to Output priority mapping)
- iMAP Device (7x00, 9x00)
 - VLANQUEUEMAP (Priority to COS Queue mapping)

Table 6-7 lists the port parameters supported by Profile Management.

TABLE 6-7 Comparison of Ethernet Port Parameters for Profile Management

Parameter	Rapier Device	Switchblade / 9800 Device	iMAP Device (9x00)
Speed/Duplex	x	x	x
Broadcast limit	x		
Destination lookup failure limit	x		
Learn	x		
Relearn	x		
Intrusive Action	x		

TABLE 6-7 Comparison of Ethernet Port Parameters for Profile Management

Parameter	Rapier Device	Switchblade / 9800 Device	iMAP Device (9x00)
Multicast limit	x		
Master/Slave mode	x		
Ingress limit	(I Series only)	x	
Egress limit	(I Series only)	x	
Acceptable traffic (VLAN or ALL)	x	x	
Input Filtering (On or OFF)	x		
Multicast MODE (A, B, or C)	x		
FC Length		x	
Jumbo		x	
Flow Control	x	x	x
QOS Policy	x	x	x
STP (with BPDU Cop)			x

TABLE 6-8 ADSL Port Parameters for Profile Management (iMAP Devices Only)

Parameter	iMAP 9x00
ADSL Line Type	x
ADSL Mode	x
Max. Interleave Delay	x
Encapsulation Type	x
Echo Cancel	x
VPI	x
VCI	x
Maximum Upstream Rate	x
Minimum Upstream Rate	x
Maximum Downstream Rate	x
Minimum Downstream Rate	x
Enable IGMP Snooping	x
ADSL Threshold values (15Min LOFs, 15Min LOLs, etc.)	x
QOS Policy	x
STP (with BPDU Cop)	

6.10.1.2 Profile Names and Scoping

Profile Scoping is a concept that allows for error-free provisioning, since it ensures that for a Profile only certain devices can be selected, or that for a device only certain Profiles can be selected. This concept is used extensively when provisioning iMGs, and complete examples are shown in Section 7.

Every device in the network has a name that uniquely identifies that device. (Usually it is the IP address, but it can be a DNS name.) When a profile is configured, the Profile Scoping field can have a value that identifies a subset of devices, usually be

using the wildcard (*) that is part of the name. For example, if Profile Scoping has the value 192.168.100.*, it includes all IP address under the 192.168.100.xxx network.

By having this Profile Scoping value, provisioning is controlled as follows:

- Whenever a Profile is part of provisioning (such as Triple Play or deploying a Profile), only those devices that match the Profile Scoping are available.
- Whenever a device is being provisioned to include profiles, only those Profiles that match the Profile Scoping are available.
- When a profile is being deployed, and the Profile included scoping, only those devices within that scope are available.

Naming conventions are as follows:

- Profile names - These can be up to 20 characters.
- Profile Scoping - The default value is None. Although expressions can be used, it is recommended that the wildcard (*) always be used since that will always provide a subset.

6.10.2 Creating a Profile

The profile feature allows the user to create, device, card, port, and iMG/RG profiles, as well as removing an association with a profile. There are two ways to access this menu:

- At the Physical Network Node, right click away from the device icons and select, for example, **Profile -> <Device Profiles>** (or one of the other profile types).
- At the Network Service Data Node, click on the Profiles leaf. The Network Services menu appears on the main menu, and the user then selects for example **Profile -> <Device Profiles>**. Refer to the following figure.

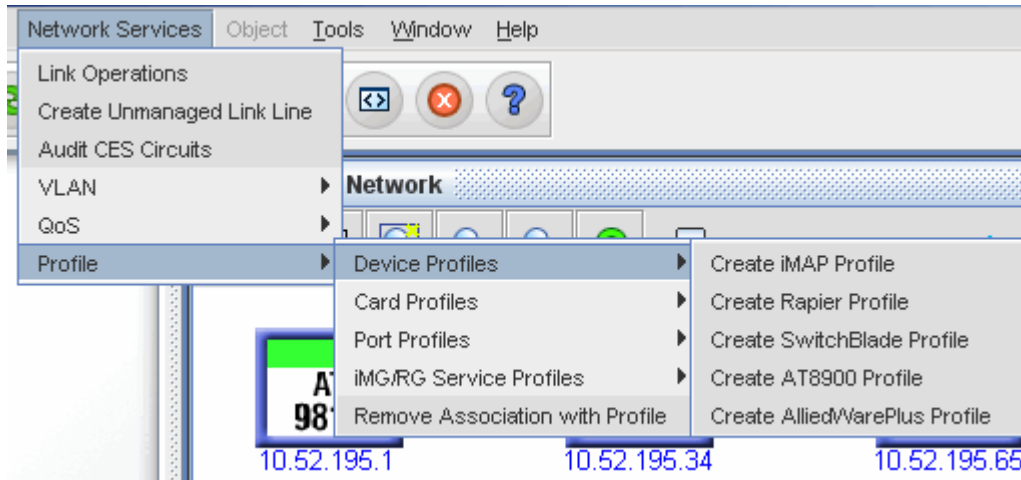

FIGURE 6-47 Using the Network Services Menu to Create a Profile - TBS

The basic steps when creating a profile are similar:

1. The user specifies the type of profile using the drop-down menu item as shown in [Figure 6-47](#).
2. The user then is presented with an entry field for the name of the Profile and a list of parameters that can be set for the selected type of profile.
3. The user can optionally copy the parameter values from a different profile of the same type to this window. This will allow the user to easily create a new profile that is similar to an existing profile.
4. The user enters the Profile name and the values for those parameters and presses the “Create” button.
5. The new Profile is stored in the NMS database.

Note: To include a QoS Policy, the user must have already defined one.

The following figures show the forms used for creating the profiles for the devices and ports.

Note: Refer to the Feature Guides for each device type for detailed information on the parameters and their values.

Following are the highlights for the Profile GUIs for NMS Release 12.0:

6.10.2.1 Profile Categories

Profiles have been grouped to improve the user interface. The groupings are shown in [6.10.1](#).

6.10.2.2 Product Types Tab for Etherlike port

Since it is designed to apply to devices that support Etherlike Ports, the Etherlike Port profile has the **Product Type** tab, under which are the device types. Refer to the following figure.

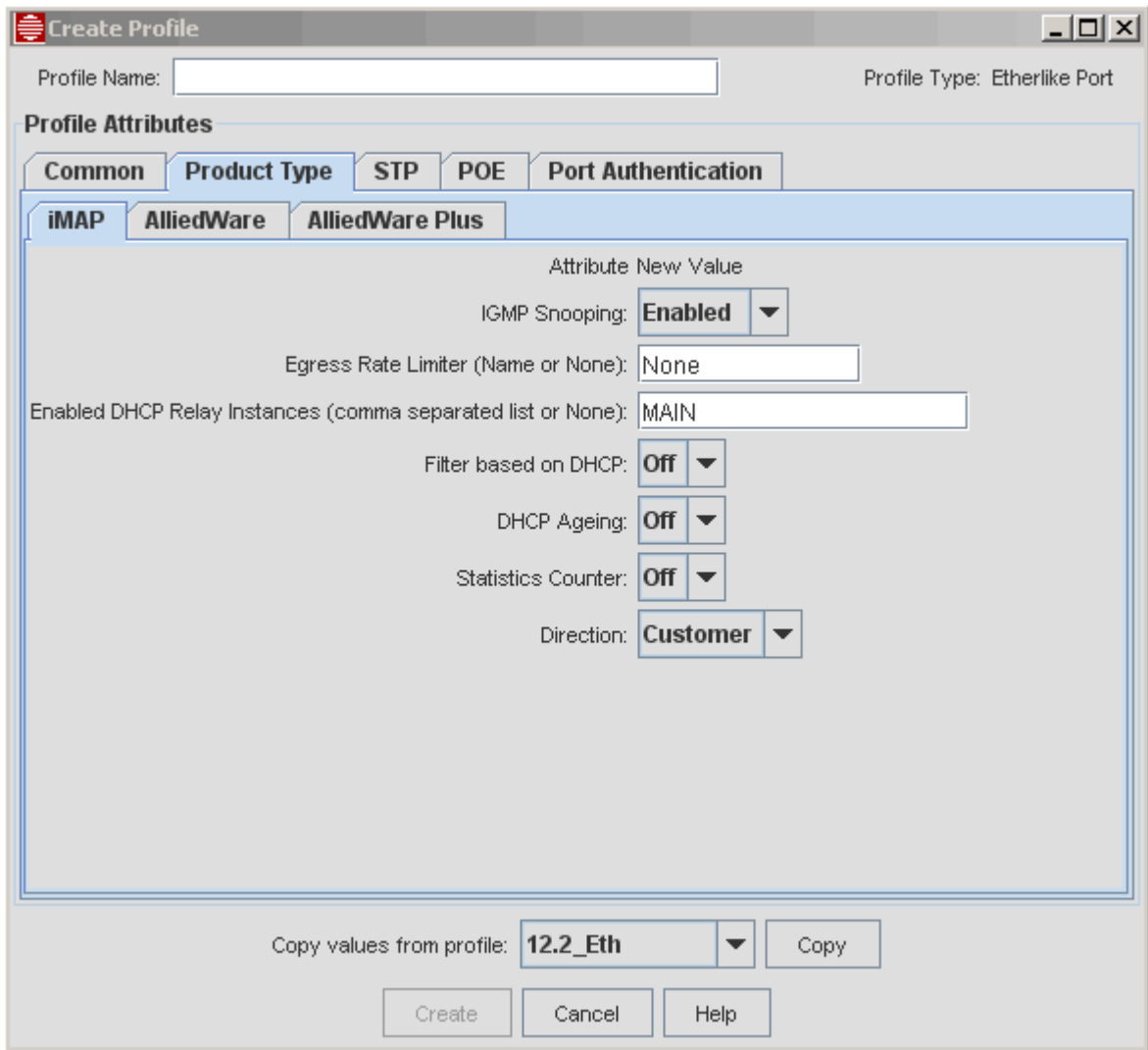

FIGURE 6-48 Create Profile for Ethernet Port - Product Type Tab

Each product type has a tool tip that includes the specific products that belong to that group. Refer to the following figure.

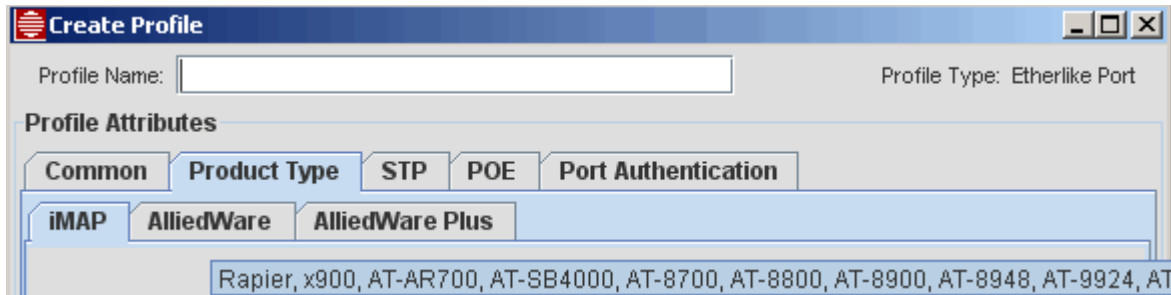

FIGURE 6-49 Tooltip for Product Type Tab

6.10.2.3 Etherlike Profile for GE24POE includes POE

To configure the GE24POE port on the SBx3112, the POE tab is included with the Etherlike Profile, as shown in the following figure.

The screenshot shows a 'Create Profile' dialog box with the following fields and options:

- Profile Name: POE_Enabled_Low
- Profile Type: Etherlike Port
- Profile Attributes tabs: Common, Product Type, STP, POE (selected), Port Authentication
- Power Over Ethernet section:
 - Attribute New Value
 - Power Over Ethernet State: Enabled (dropdown)
 - Priority: Low (dropdown)
 - Power Shutoff Limit (Class or 1..30 Watts): Class (text input)
- Copy values from profile: Etherlike12.2 (dropdown) with a Copy button
- Buttons: Create, Cancel, Help

FIGURE 6-50 Etherlike Profile for POE

The three values to be filled in are:

- Power Over Ethernet State - Whether to enable or disable the feature
- Priority - Ports with lower priority will stop being powered when the system cannot allocate enough power to all ports.
- Power Shutoff Limit - Power will be cut off if it exceeds the set threshold

For detailed information on the parameters, refer to the *SBx3112 Product Guide*.

6.10.2.4 Etherlike Profile for GE24 Ports Includes Port Authentication

For GE24 ports on the SBx3112, there is also the Port Authentication feature. Refer to [6.22](#).

6.10.3 Viewing and Modifying Profiles

Once the profiles are created, they can be viewed by selecting the Profile node under the Network Data Services object, as shown in the following figure.

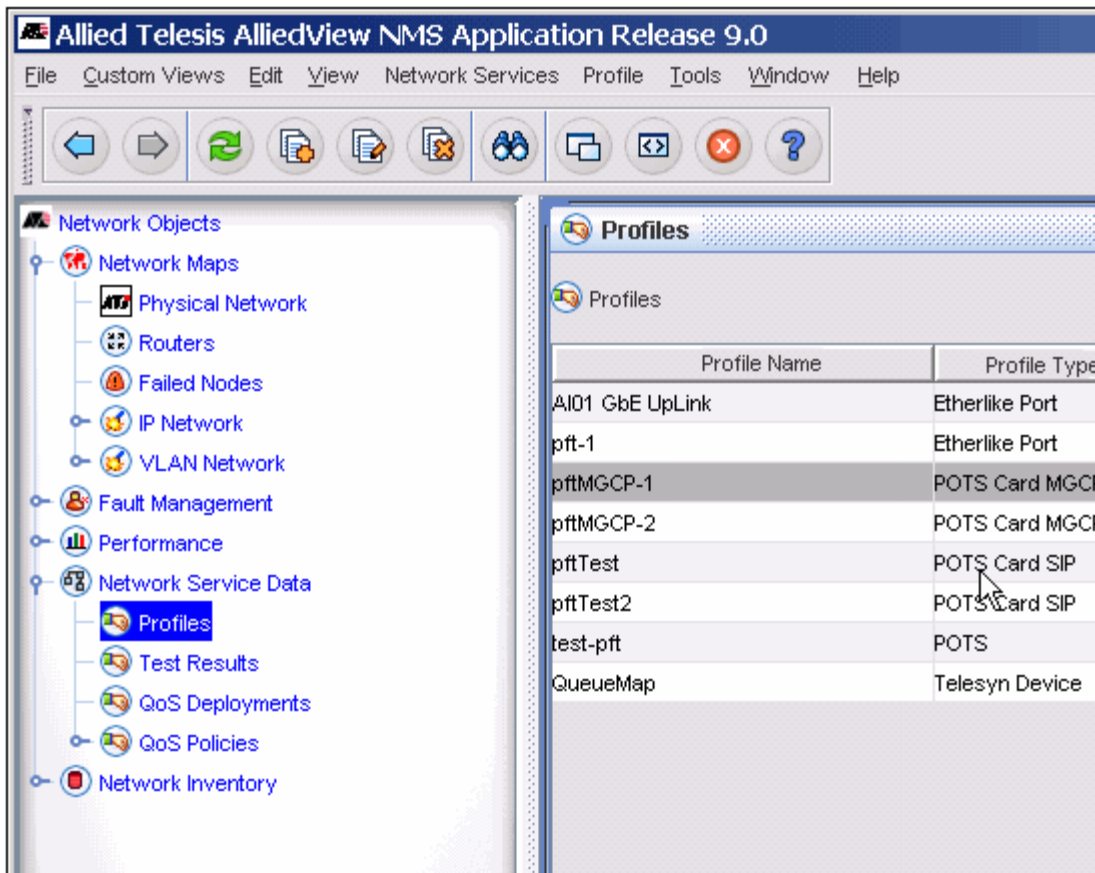

FIGURE 6-51 Viewing the List of Profiles (includes POTS24 Card Profiles)

The profiles can be viewed like other attributes, so they can be sorted, scrolled, and have a search function.

To view or modify the details of the profile, the user can right click the profile and select View Profile, or double-click the profile. The **Modify Profile** Form appears, and when the user changes any parameter the **Modify** button is activated.

Note: At this point, the profiles have not been deployed, and so changing any values has no effect on what parameter values are actually used on any devices or ports. The relationship between deployed profiles and the changing of parameter values is discussed later.

Note: Creating and deploying profiles for the EPON and ONU requires particular attention since the user must understand the attributes of the EPON and ONU interface policies.

6.10.4 Deleting a Profile

The user can delete a profile if it is not being used (deployed) on a device or port. To delete a profile, right click on the profile and select Delete Profile. A confirmation window confirms the deletion.

Note: This operation will fail if there are any objects (devices or ports) in the network that are currently using one of the profiles to be deleted. If there are objects currently using one of the profiles, the user can apply some other Profile (such as a default profile) to those objects and then successfully delete the profile.

6.10.5 Deploying a Profile

To deploy a profile means to apply the configuration values assigned in a Profile to a set of objects (devices or ports) in the network.

Note: The set of objects on which to apply the Profile must be of the same type as the Profile.

When **Device** Profiles are applied to devices, the device selection mechanism will provide for:

- Applying the Device Profile to a selected list of devices
- Applying the Device Profile to all devices that are currently using a particular Device Profile
- Applying the Device Profile to all devices in a particular network/sub-network.

When **Port** Profiles are applied to ports, the ports selected can be across multiple different device types. The user can therefore:

- Apply the Port Profile to all ports (of the correct type) on a selected list of devices
- Apply the Port Profile to ports (of the correct type) on a selected list of devices that are currently using a particular Port Profile.
- Apply the Port Profile to all ports (of the correct type) on all devices that are currently using a particular Port Profile.
- Apply the Port Profile to a selected set of ports (of the correct type) on selected devices where the set of ports can be different for each of the selected devices.
- Apply the Port Profile to all ports (of the correct type) on the selected list of devices that are not currently configured to use a profile (or are using the default profile).
- Apply the Port Profile to the Auto provisioning profile of a device.

To deploy a profile, right click on a profile in the Profiles table (see [Figure 6-51](#)) and select **Deploy Profile**. The Deploy Port Profile Form appears.

*Note: The user can also select **Profile -> Deploy Profile** from the main menu. Note that the Profile menu item includes *, which indicates out of sync.*

To fill out this form, follow these steps:

1. Enter the device or port selection method (one of the selection methods described in bullet lists at the top of this section).
2. Depending on the selection method chosen, select the devices and/or ports on which to apply the profile.

Note: If the Profile Scoping field was used in filling out the Profile, only those devices that match the Profile Scoping are available.

3. Press the **Deploy** button.
4. An AlliedView NMS Task Details window is displayed indicating the progress of the Profile Deployment task as the devices in the network are updated.
5. The “Node” or “Configured Ports” tables will be updated to indicate that the selected devices or ports are now using the selected Profile. (This is part of Profile Monitoring, described in [6.10.9](#).)

Task Name: Deploy ADSL1

Profile Name: ADSL1 **Profile Type:** ADSL

Device Selector

All Devices

Selected Devices:

Selected Nodes	
	172.16.33.11
	172.16.33.19

Port Selector

All Ports (of correct Type)

Ports currently using Profile: ADSL1 ▼

Selected Ports:

Device	Ports (e.g. 1, 3-5 or 1.4-1.9,2.6)
172.16.33.11	
172.16.33.19	

FIGURE 6-52 Deploy on Port Profile Form

FIGURE 6-53 Deploy on Device Profile Form

Customer ID	Access Device_slot.port	Current IP Address	Current Profile
iMG616BD	10.52.30.37_13.9	10.52.31.101	12.0_SIP
iMG616W	10.52.30.35_5.11	10.52.31.103	12.0_SIP
iMG634WAR2	10.52.30.37_10.1	10.52.31.118	12.0_SIP
iMG646BD	10.52.30.35_5.5	10.52.31.121	12.0_SIP

FIGURE 6-54 Deploy an iMG/RGDeploy iMG/RG Profile

6.10.6 Redeploying a Profile

There are times when a user needs to re-synchronize the parameters stored in the Profile on the NMS with the configuration of the actual devices or ports in the network. This could be needed after a change is made to the Profile, or when the user wants to reset any temporary changes made to individual ports in the network back to the Profile configuration. To re-apply or re-deploy a profile to the network, follow these steps:

1. Bring up the Profile Deployment window for a device or port.
2. To re-deploy Port Profiles select **Apply to ports with Profile** port selection method.
3. To re-deploy Device Profiles select **Apply to devices with Profile** device selection method.
4. Select the current profile.
5. Press the **Deploy** button.
6. The NMS will start a Task to reset all the parameters on the appropriate device(s) or port(s) to match those defined in the Profile.

Note: The NMS will only set parameters where the value on the device differs for the value in the Profile.

6.10.7 Scheduling Deployment of a Profile

There are situations where a Profile should be deployed at a particular time in the future (such as pending service activation) or at regular intervals (such as switching back and forth between two Profiles based on time of day or day of week). To schedule the deployment of a profile follow these steps:

1. Sets up a profile deployment.
2. Instead of pressing the **Deploy** button, press the **Next** button to bring up the scheduling window.
3. Select One Time schedule or Recurring schedule and the appropriate parameters for each.
4. Press the **Finish** button to submit the request to the NMS scheduler.
5. At the specified time(s), the NMS deploys the Profile.

Note: The scheduling mechanism will be the same one as used by the Device Backup/Restore and Software Download applications.

Task Name:

Profile Name: AI01 GbE UpLink Profile Type: Etherlike Port

Schedule

Now

Hold

One Time:

Recurring:

Time:

Recur Weekly Sun Mon Tue Wed Thu Fri Sat

Recur Monthly on the of the month

FIGURE 6-55 Deploy Port Profile Form - Scheduling

6.10.8 Deploying Changes to a Profile

When a Profile is modified on the NMS, any device or port in the network using that profile will no longer be consistent with the Profile on the NMS. When modifying a Profile on the NMS, the NMS will allow the user to have the NMS automatically push the changes in the profile to the objects (devices or ports) in the network to which the profile had been applied. Follow these steps:

1. Modify a Profile as defined in [6.10.3](#).
2. The NMS prompts the user whether the changes should be deployed to the objects (devices or port) in the network currently using that Profile.
3. If yes, the profile will be redeployed.

6.10.9 Profile Monitoring

Profile monitoring is the process tracking the Profiles being used by objects in the network. It also includes the tracking of whether the individual settings of the object are consistent with the parameters defined in the Profile that was applied to it. The settings can deviate from the Profiles over time as the devices are manipulated through non-AlliedView NMS methods (such as using the CLI directly). To better manage the Profiles, the NMS monitors the Profile to port and device associations in the network.

6.10.9.1 Viewing Profile to Port Associations

The user can view a list of ports that indicate which Port Profile each of the ports is currently using. This view will also indicate whether the parameters set on the port are still consistent with the Port Profile defined on the NMS. Perform the following steps:

Note: The table used to display the Port Profile usage will be that same table that indicates the Customer ID associated with each port. This panel is named “Configured Ports”.

1. Select the “Ports” panel under the Network Inventory Object.
2. The Ports panel will contain a table that lists the configured ports in the network. The columns in the table include the device/slot/port of the port, the customer id associated with the port, and the Port Profile associated with the port with an indication as to whether the port configuration is in sync with the Port Profile settings defined in the NMS.

6.10.9.2 Viewing Profile to Device Associations

The user can view a list of devices that indicate which Device Profile each of the devices is currently using. This view will also indicate whether the parameters set on the device are still consistent with the Device Profile defined on the NMS.

1. Select the “Profile Association” panel under “Nodes”.
2. The Profile Association panel will contain a table that lists the devices in the network. The columns in the table include the name, type, ip address, and Device Profile with an indication whether the device configuration is in sync with the Device Profile settings defined in the NMS.

6.10.10 Keeping the Profile Parameters and Ports/Devices in Sync

Over time, either through the NMS or directly with the devices, the user can make changes to the devices or ports so that they are no longer in sync with the configuration defined in the Profiles. The NMS must discover this discrepancy and keep the Ports and Profile Association Panels up to date.

- To check for changes made directly to the device that affect the device level configuration, the NMS rediscovery process compares the values on the device with the Device Profile that was applied to it and update the Node table accordingly. This means that a change on the device will go undetected by the NMS only until the next rediscovery of the device is automatically invoked by the NMS.
- To check for changes made directly to the device that affect the port configuration, the NMS rediscovery process will compare the port configuration on the device with the Port Profile that was applied to it and update the Configured Ports table accordingly. This means that a change on the device will go undetected by the NMS only until the next rediscovery of the device is automatically invoked by the NMS.
- For changes made through the NMS, the applications that make the changes to a device or port will update the NMS tables immediately.

Note: When a profile is out of sync with what has been defined on the device, a “*” is next to the profile name in the Profile column of the Port or Device table.

6.10.11 Coordination of External and NMS Profiles

As described above, the *AlliedView* NMS profiles operate at the network service level; a profile is created for a card type or port type, and can then be applied to multiple interfaces over multiple devices. Moreover, the profiles include a more global set of attributes, such as traffic and performance management attributes. Finally, the profiles are filled out using pull-down menus and GUIs, ensuring there is less chance of error.

For the *iMAP*, prior to release 11.0, if a Profile was created at the NMS and applied to an interface, the *iMAP* output for the interface would not show that an NMS profile had been applied.

In release 11.0, this is changed; when the NMS sets the port attributes by deploying an NMS profile, the `SHOW INTERFACE` command on the *iMAP* displays the NMS profile name that has been applied as an **External Profile** name. Moreover, if at the NMS a port is de provisioned, the *iMAP* output for External Profile is set to None.

At the NMS, when an *iMAP* port is displayed, the current value of the External Profile name will be displayed at or near the bottom of the view-only attributes, labeled “Interface Profile Name”. Normally this name will match the Profile name deployed by the NMS (displayed upper right). Refer to the following figure.

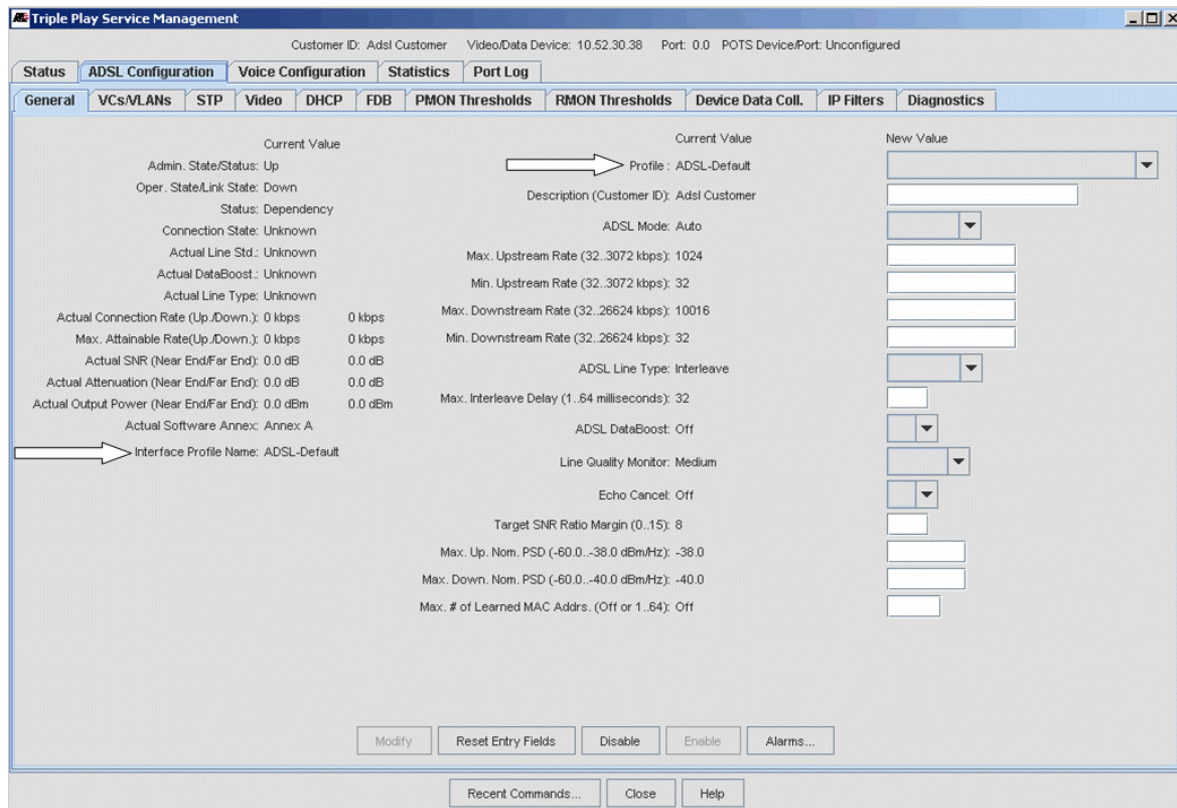

FIGURE 6-56 ADSL Details - NMS and Interface Profile

Whenever a profile is deployed by the NMS to the port, the Interface Profile Name will be set to the port Profile name. Note that there is no other way to change the Interface Profile Name via the NMS. If for whatever reason the names do not match, for example someone changes the external profile name on the device using the CLI, the port profile name (upper right) will be marked with an asterisk. Normally this will only be detected during discovery, when the NMS automatically performs port-profile comparison.

Note: The administrator must therefore be aware that if the External Profile Name is changed at the CLI, there will be no notification of this at the NMS until the device is (re)discovered.

When a port is activated from the Ports Inventory table, a message such as the following will be displayed if the profile name and external profile name do not match exactly:

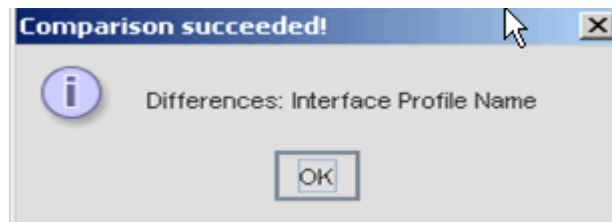

FIGURE 6-57 NMS and External Profile Name do not Match

When the names match and no other parameter mismatches, the usual message is displayed:

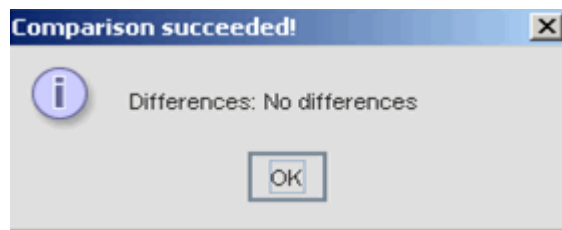

FIGURE 6-58 NMS and External Profile Name Match

6.10.12 ADSL G.Bond Creation and use of Profiles

In release 11.0, there is support for G.bond (ITU G.998) for ADSL interfaces.

Note: Refer to the *Allied Telesis iMAP User Guide* for detailed information on provisioning G.Bond, feature operation, and alarms/performance monitoring.

To provision this, there is the profile called ADSLBOND, and it contains references to two regular ADSL profiles, referred to as the Primary and Secondary profiles. (Refer to Figure 6-59)

In release 11.0 there is support for only two ADSL interfaces, but the use of Primary and Secondary profiles is sufficient since there is always one Primary (Root) port, with all other ports as Secondary.

Normally, the same ADSL profile is used for both the Primary and Secondary profile, so when the Primary is selected the Secondary defaults to the same profile. Additional fields (explained in the iMAP User Guide) are the minimum upstream/downstream rates.

Since Tagged and Untagged VLANs can be attached to the ETH interface of the bond, the referenced ADSL profiles must **not** contain VLAN information. Therefore, ADSL profiles that are referenced by an ADSL-BOND profile must have their "Include VLAN Configuration" value disabled. The QOS Policy parameter is treated similarly; it must be set to NONE in ADSL profiles that are referenced by ATM-BOND profiles.

During creation of an ADSL-BOND profile, if no appropriate ADSL profiles can be found, a window will popup explaining these requirements and then the profile window will close.

The screenshot shows a 'Create Profile' dialog box with the following fields and values:

- Profile Name: ATMBOND-2
- Profile Type: ADSLBOND
- Profile Attributes section:
 - Attribute New Value
 - Profile Scoping: None
 - Primary ADSL Profile: ADSL-1
 - Secondary ADSL Profile: ADSL-2
 - Number of Pairs: 2
 - Min.Agg.UpstreamRate(32..6144): 1024
 - Min.Agg.DownstreamRate(32..53248): 10240
 - Include VLAN Configuration in Profile: False
 - Untagged VLAN (1..4094 or None):
 - Tagged VLANs (comma separated list or None):
 - QOS Policy: None
- Copy values from profile: ATMBOND-1
- Buttons: Create, Cancel, Help

FIGURE 6-59 ADSL-Bond Profile

6.10.13 Multiple VC Support on ADSL Port

As part of configuring the iMG/RG, there is the option of datafilled multiple VCs for the ADSL connection. This is explained in 7.5.9.

6.10.14 Multiple VC Support on SHDSL Port

In NMS release 11.0 SP4, the SHDSL Profile allows the user to configure up to four VCs.

6.10.15 Multiple VC Support on VDSL Port

6.10.15.1 Overview

On the iMAP, there has been support for provisioning multiple VCs for the VDSL A/B cards in ADSL or VDSL mode over ATM. However, this was not supported on the NMS. In NMS release 11.0 SP4, this feature is added.

Like the ADSL24A/B, the VDSL24A/B cards support the provisioning of VCs as long as the port is running ATM in either ADSL or VDSL mode. Up to 4 AAL5 VCs per ATM interface can be configured with different VPI/VCI pairs. Moreover, the same rules apply for the VDSL24A/B card as with the other ADSL cards that support multi-VCs (sub-interface zero is created by default and cannot be destroyed).

Prior to this feature, only one VC could be provisioned on the VDSL port when it was operating in ADSL or VDSL mode over PTM.

Messages are added to the GUI so that the administrator is informed when the transport mode is set to PTM, VCs cannot be provisioned. This and the other GUI changes are explained below.

6.10.15.2 Create/Modify VDSL Profile

The Create VDSL Profile is changed so that when the transport mode is set to ATM, there is the option to data fill up to four VCs. (VC 0 always exists and cannot be deleted.) Refer to the following figure.

Profile Name: Profile Type: VDSL

Profile Attributes

General Rate Settings **VC/VLAN Info** STP VDSL Thresholds

Attribute New Value

Include VC/VLAN Configuration in Profile: **True** ▼

VCs

VC	Exists	VPI	VCI	Untagged VLAN ID	Tagged VLAN IDs	Trans
0	<input checked="" type="checkbox"/>	0	35	1		
1	<input type="checkbox"/>					
2	<input type="checkbox"/>					
3	<input type="checkbox"/>					

Valid Attribute Values:

- VPI: 0..255
- VCI: 32..65535
- Untagged VLAN ID: 1..4094
- Tagged VLAN IDs: Empty or comma separated list of numbers from 1..4094
- Transmit PCR (Peak Cell Rate): "MAX" or # cells per second from 150..65535

Up to four VCs can be provisioned

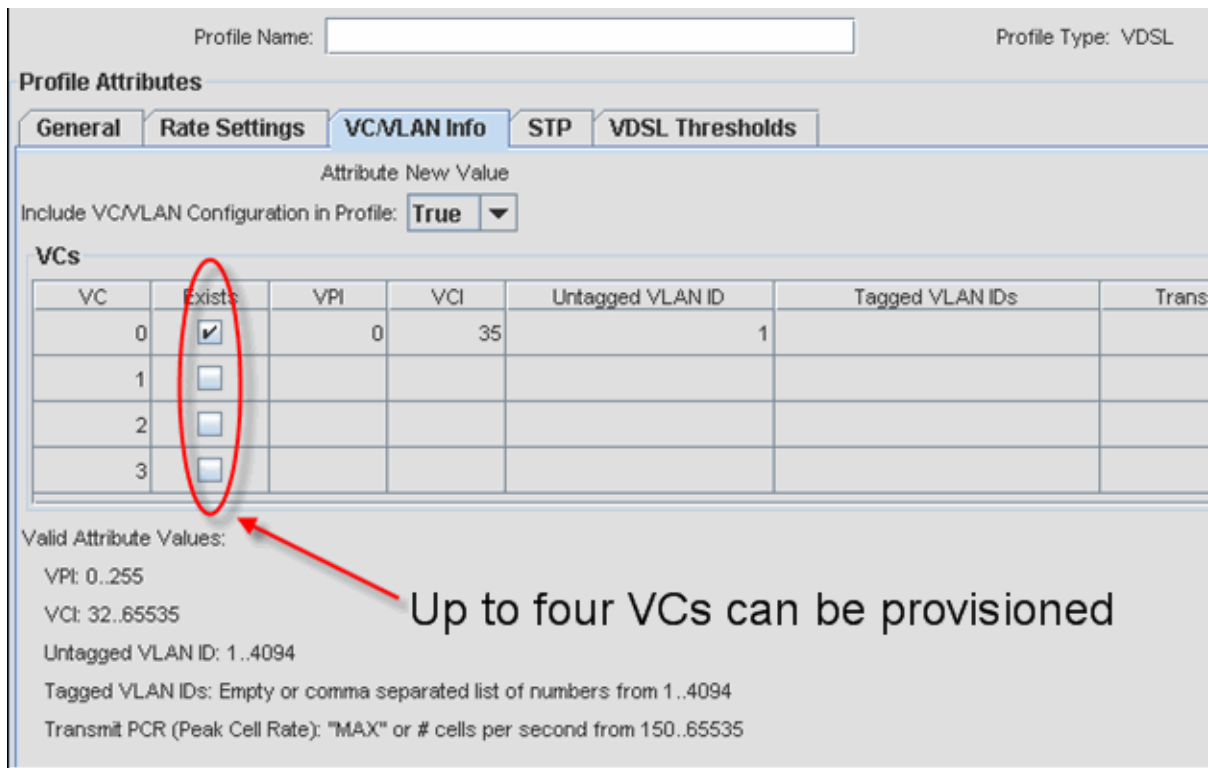

FIGURE 6-60 VDSL Profile - VCs in ATM Mode

When the Transport Protocol is set to PTM the user will receive a warning, as shown in the following figure.

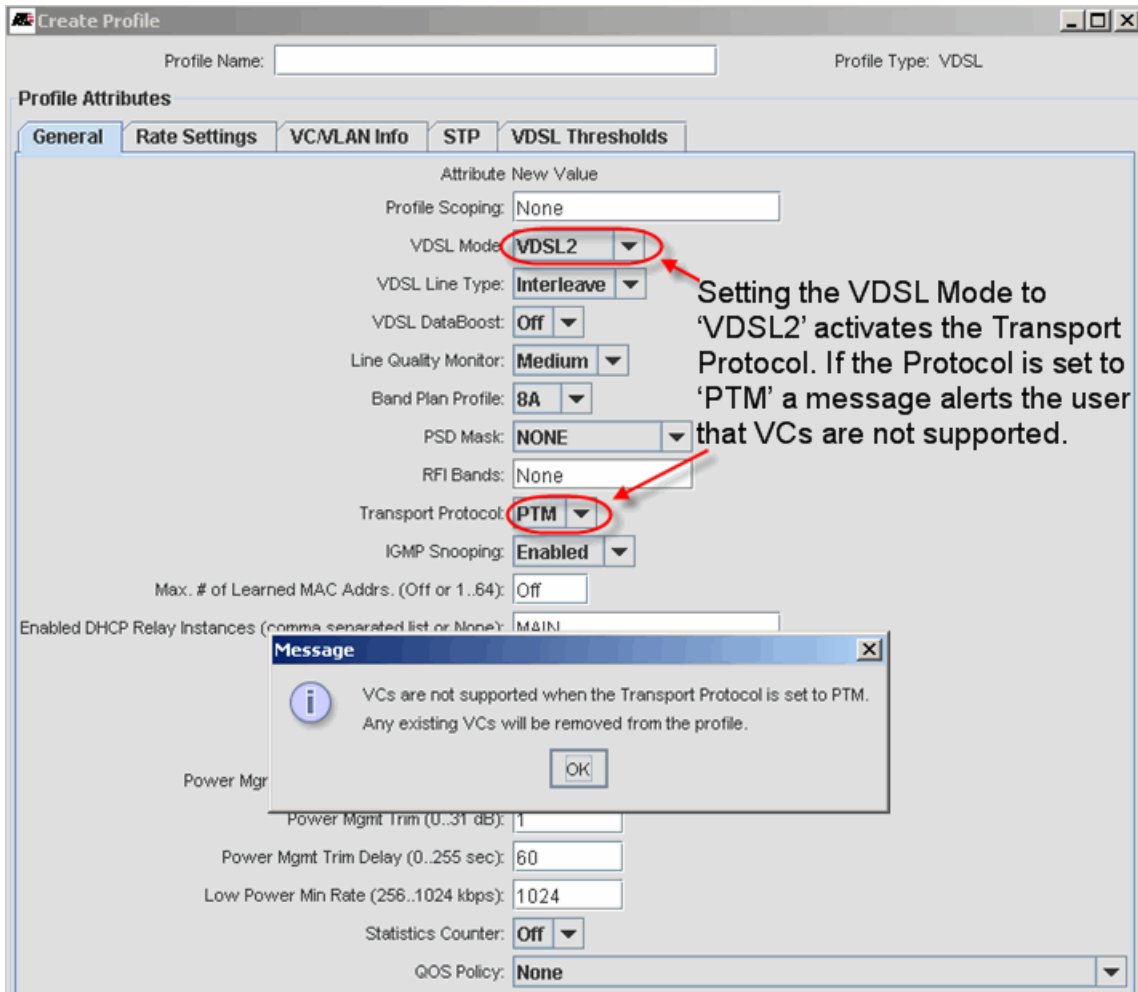

FIGURE 6-61 Setting the Transport Protocol to PTM (VDSL Port)

After clicking OK, the administrator can go to the VC/VLAN tab and see that there are no VCs, as shown in the following figure.

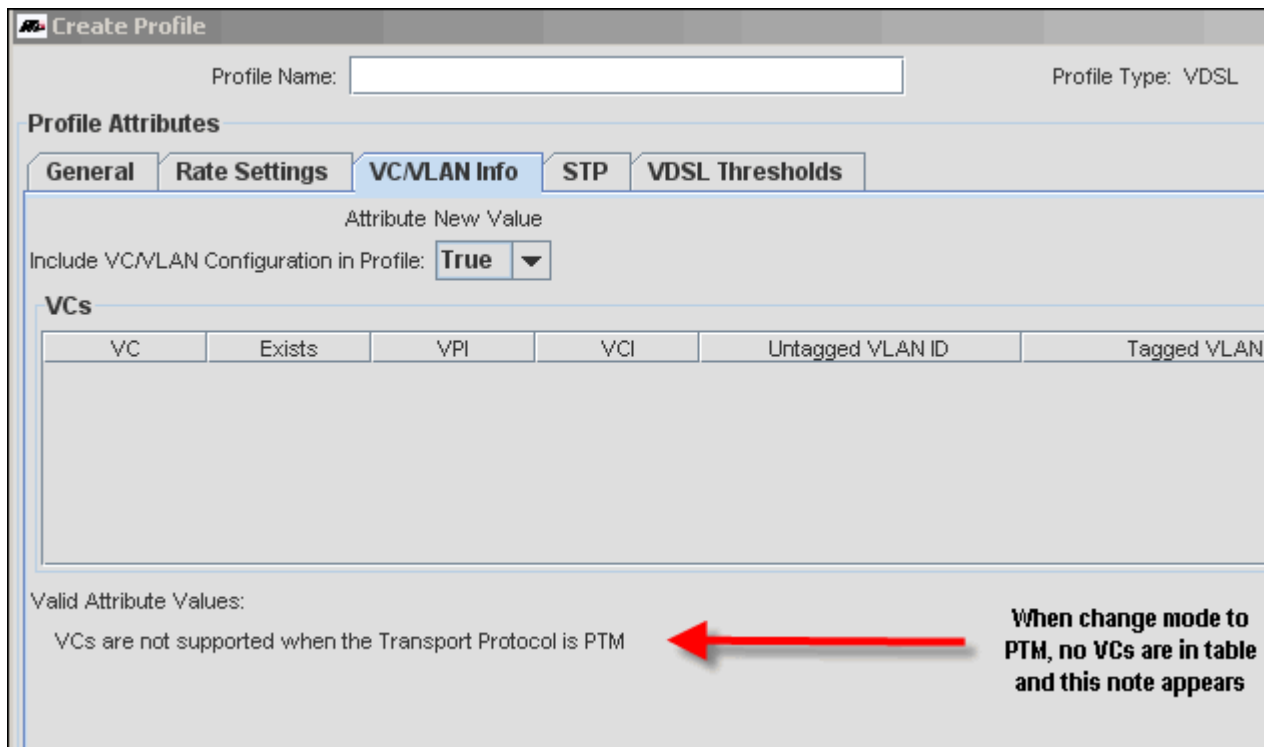

FIGURE 6-62 VC/VLAN Tab when VDSL in PTM Mode

The Modify VDSL Profile VC/VLAN tab has two tables, one for the current settings in the profile, and one for putting in changes. This has the same behavior as the Create VDSL Profile, in that the Transport protocol settings alter these tables. Refer to the following figures.

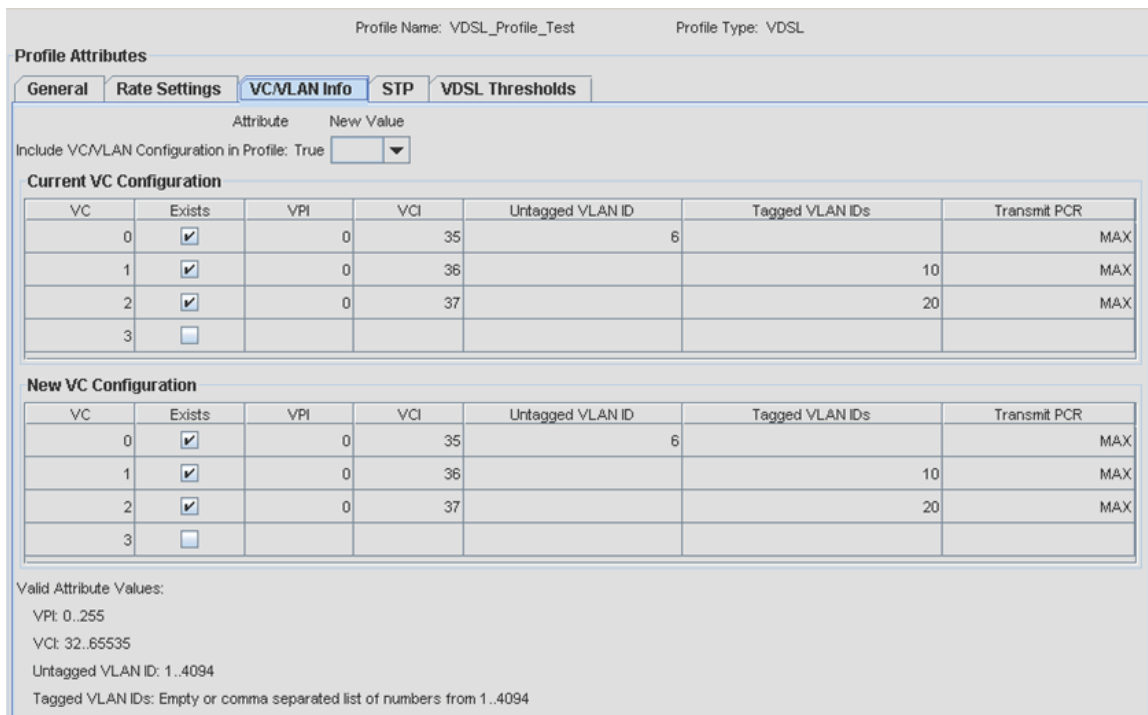

FIGURE 6-63 Modify Profile before Mode set to PTM

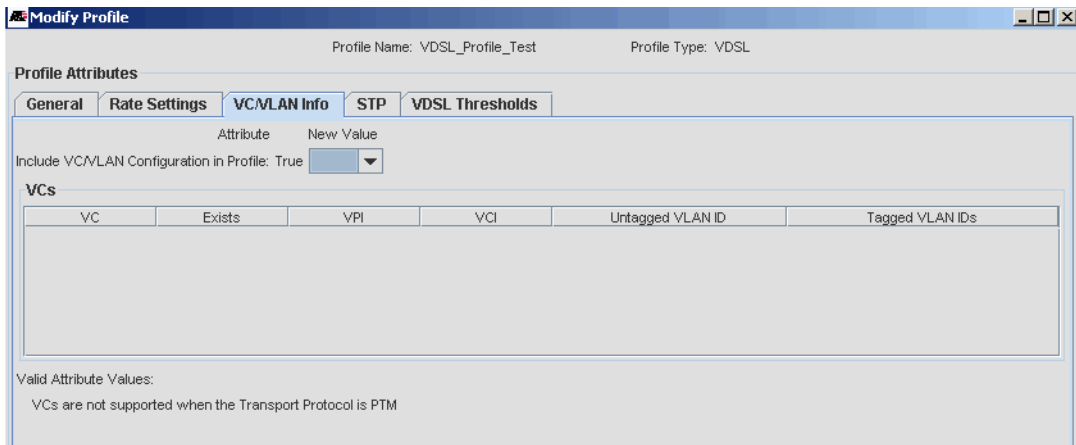

FIGURE 6-64 Modify Profile after Mode set to PTM

6.10.15.3 Triple Play Service Management Form

The Triple Play Service Management form, VDSL Configuration tab also reflects the multiple-VC provisioning, as shown in the following figures.

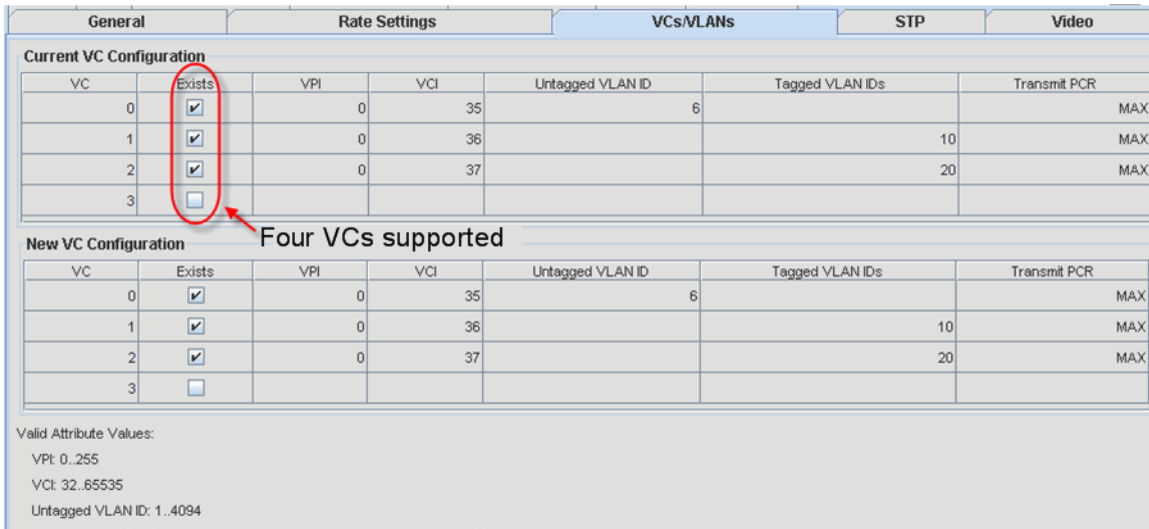

FIGURE 6-65 VDSL Service Management Form - ATM Mode

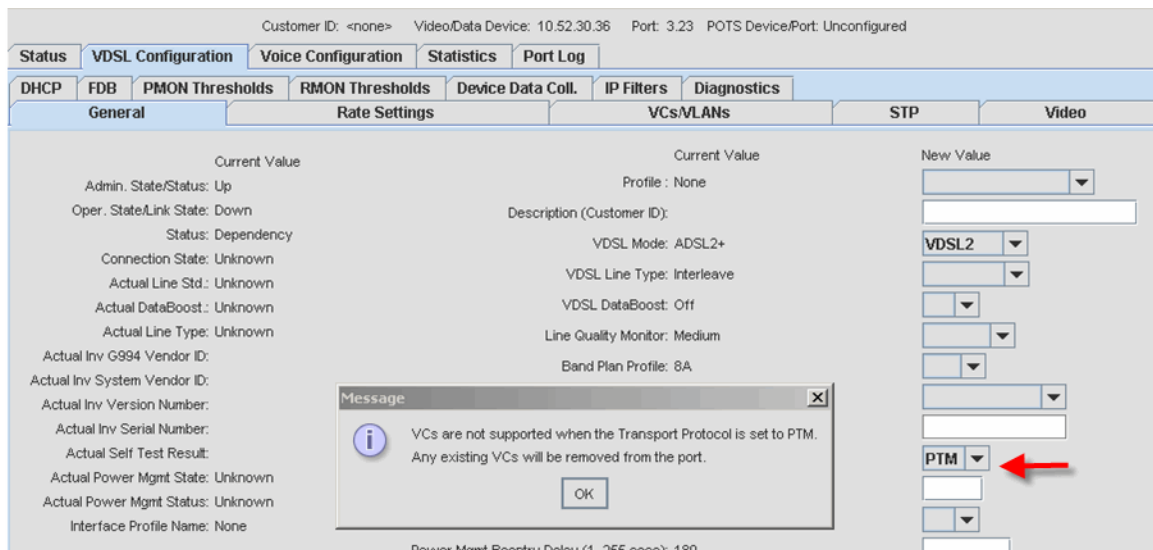

FIGURE 6-66 Message if Change Mode to PTM

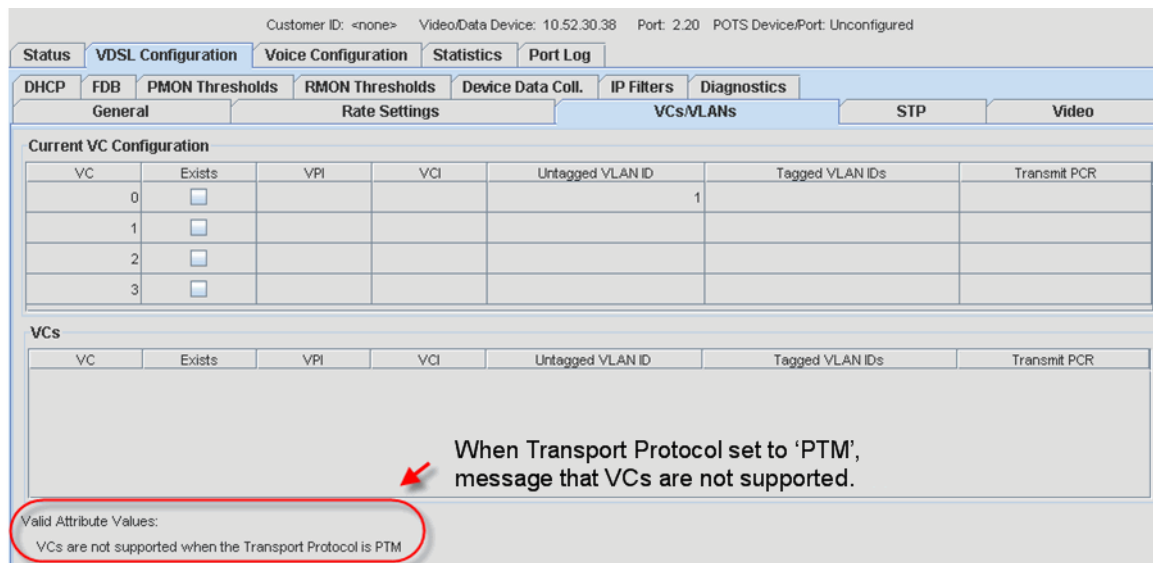

FIGURE 6-67 VCs/VLAN tab when in PTM Mode

Changes to the View/Modify tabs are done on a per tab basis. As an example, if someone makes changes to the General tab and then makes changes to the VCs/VLANs tab, pressing the “Modify” button will only pick up the current tabs changes. Because of this, an administrator can change the Transport to “ATM” (from “PTM”) and then make changes to the VCs/VLANs table. If they then attempt to save the changes to the VCs/VLANs table by selecting the “Modify” button, the data would not be valid if sent to the port because it would still be configured as “PTM”. In this situation, a dialog box is opened to indicate that the changes made to the General tab must be saved prior to saving the changes on the VCs/VLANs tab. Refer to the following figure.

Customer ID: Steve_Profile_Test Video/Data Device: 10.52.30.36 Port: 3.4 POTS Device/Port: Unconfigured

Current VC Configuration

VC	Exists	VPI	VCI	Untagged VLAN ID	Tagged VLAN IDs	Transmit PCR
0	<input type="checkbox"/>			6		
1	<input type="checkbox"/>					
2	<input type="checkbox"/>					
3	<input type="checkbox"/>					

New VC Configuration

VC	Exists	VPI	VCI	Untagged VLAN ID	Tagged VLAN IDs	Transmit PCR
0	<input checked="" type="checkbox"/>	0	35	6		MAX
1	<input checked="" type="checkbox"/>	0	36		10	MAX
2	<input type="checkbox"/>					
3	<input type="checkbox"/>					

Valid Attribute Values:
 VPI: 0..255
 VCI: 32..65535
 Untagged VLAN ID: 1..4094
 Tagged VLAN IDs: Empty or comma separated list of numbers from 1..4094

Message

Before modifying the VCs on the port you must commit the changes made to the Transport Protocol on the General tab.

FIGURE 6-68 Message to Save Protocol Change before changing VC Configuration

6.10.16 DS3 SFP Support

To provide DS3 support, in iMAP release 12.0 the 9000 iMAP devices (except the 9100) add support for a DS3 SFP. (This is currently the MiRICi-T3, which integrates a complete DS3 interface and a Gigabit Ethernet interworking function into the form factor of a standard SFP optics device.)

Note: For complete information on the DS3 SFP feature, refer to the iMAP User Guide.

To provision a GE3/GE8 port that includes this DS3 SFP, a profile labeled Etherlike DS3 Port profile is added to the list of profiles available, as shown in the following figure.

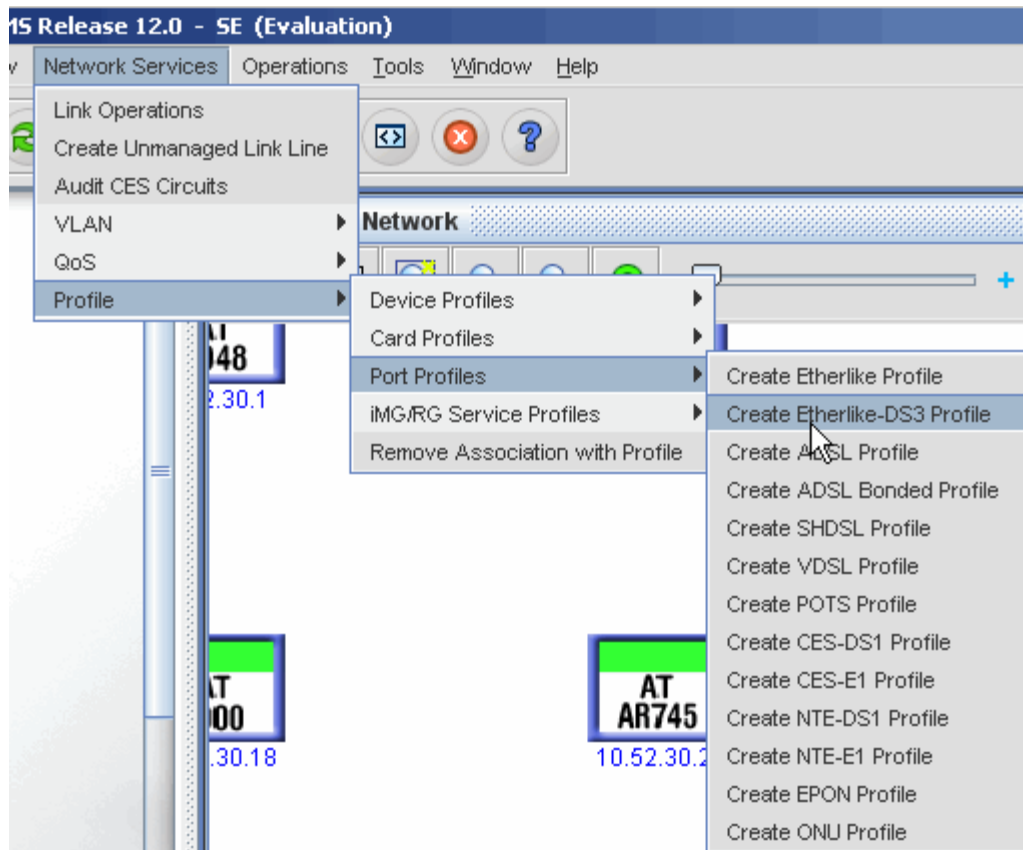

FIGURE 6-69 Profile for DS3 SFP

The profile is used to provision both the Ethernet and DS3 interfaces and has four tabs:

- **Common** - This is similar to the Common tab for the Etherlike port Profile, except that the Speed must be set to 1Gbps and Duplex must be Full Duplex. (Auto Negotiation is not supported).
- **iMAP** - This tab is similar to Etherlike Port profile. The default Direction for this configuration is set to Network, which disables the DHCP parameters.
- **DS3-SFP** - This is specifically for the GE port that will include the DS3 SFP, and these parameters must be coordinated with those at the other end. For information on these parameters, refer to the iMAP User Guide.
- **STP** - This is similar to the Etherlike Port profile.

Caution: To ensure that the user does not set an egress rate that exceeds the capacity of the DS3 (45Mbps), you must, in the iMAP tab, provision an Egress Rate Limiter that does not exceed the 45Mbps rate. If it is not set, you receive a warning about this and that currently no Egress Rate Limiter is set. If you do type in an Egress Rate Limiter, you receive the same warning and that the Rate Limiter typed in must not exceed 45Mbps. Refer to the following figures.

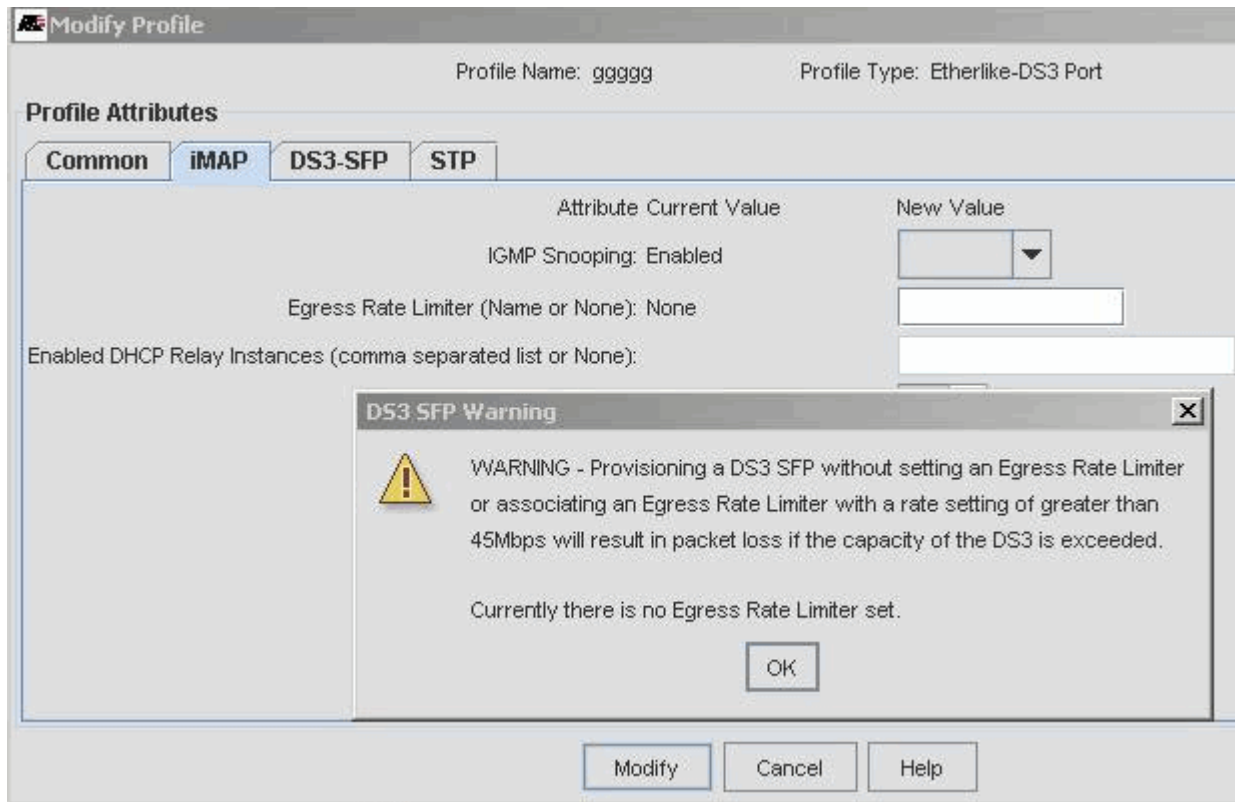

FIGURE 6-70 Warning when no Egress Rate Limiter is Set

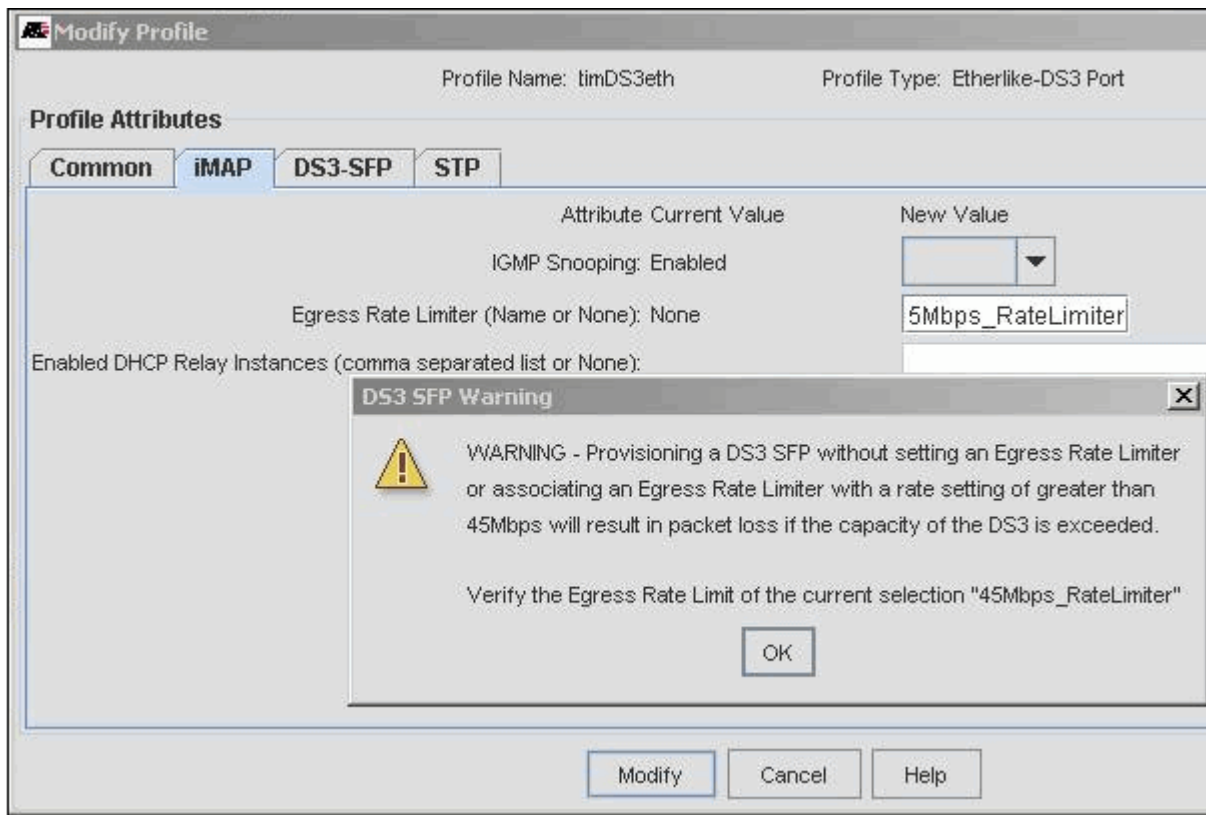

FIGURE 6-71 Warning When Egress Rate Limiter is Set

To provision the DS3 SFP, select an unused Ethernet port (GE or GE8) and select Provision New Customer/Port. The only fields that need to be filled in are the Customer ID and Port Profile, as shown in the following figure.

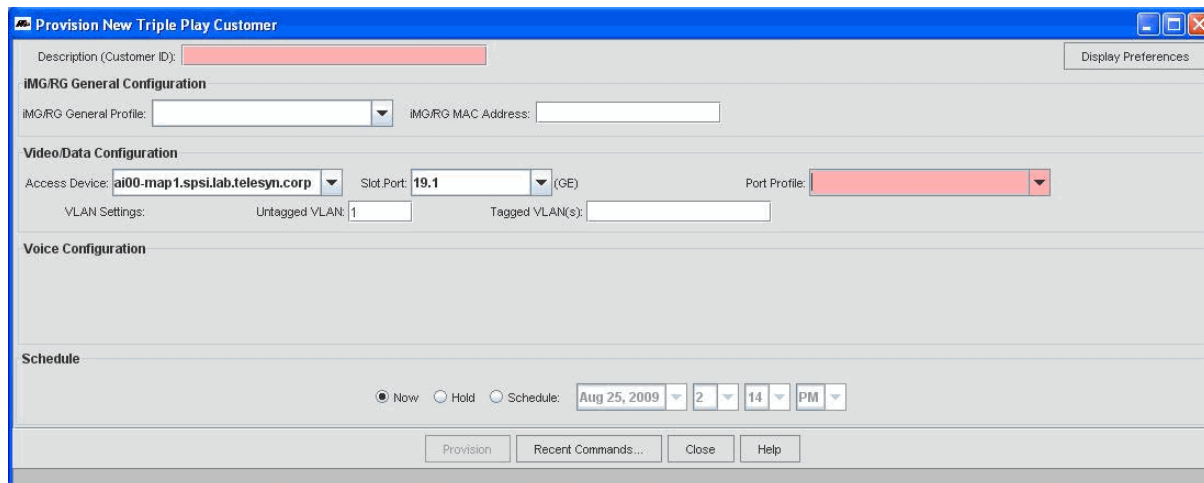

FIGURE 6-72 Provision Etherlike Port for DS3 SFP

After the fields are filled in and **Provision** is selected, the status of the port changes, with the Customer ID included and the Status being:

- Down if the SFP has not been inserted, or the Ethernet or DS3 interface has failed.
- Up if an SFP has been inserted and both interfaces are operationally up.

Note: For traffic to flow, both the DS3 and GE interfaces must be operationally up, and any condition that causes one to go operationally down (such as an alarm or being administratively disabled) will cause the other to go operationally down with a failing condition and alarm.

Once the port is provisioned, you can review the in the Service Management Details for the port. This is similar to other Ethernet ports except for the following:

- General - The state of the DS3 link. Note that the relationship between the DS3 and the associated GE interface is associative rather than parent/child. Refer to the iMAP User Guide for more information. Refer to the following figure.

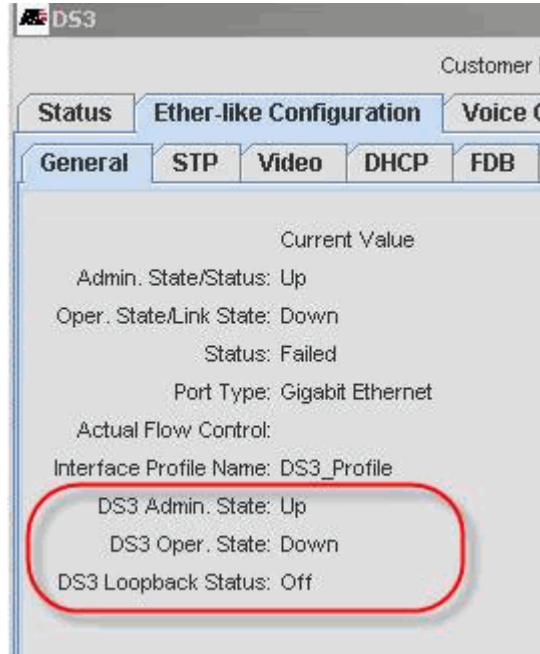

FIGURE 6-73 DS3 - EtherLike Configuration, General Tab

- DS3-SFP - This is under the Ether-like Configuration tab, and not only the DS3-SFP settings, but the setting of the Loopback Status. If set to On, the Loopback Type and Location are activated and can be set.

Note: The port must be operationally down to set a loopback.

Refer to the following figure.

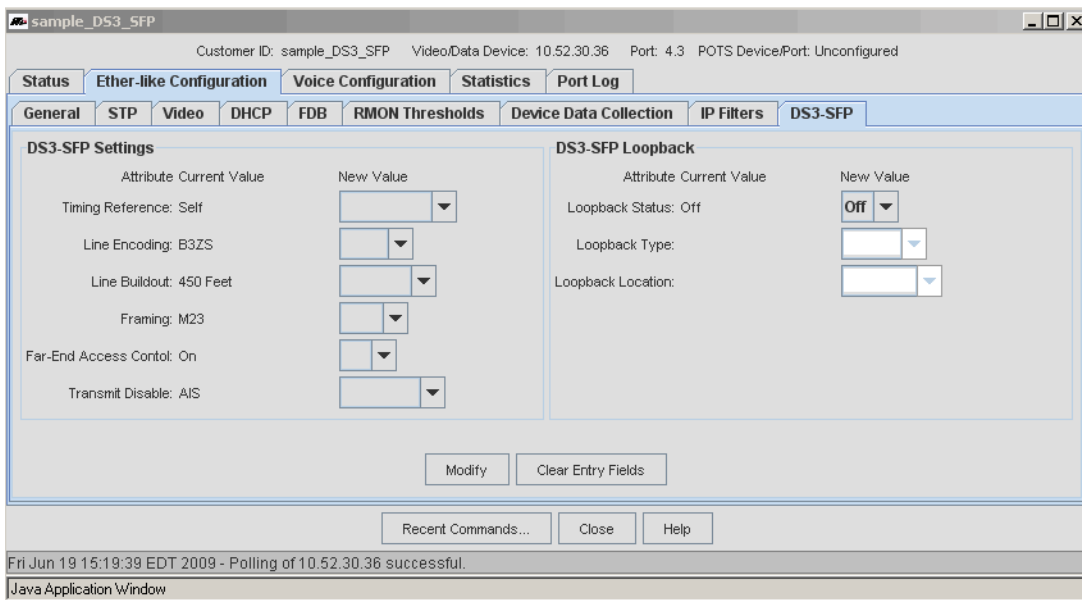

FIGURE 6-74 DS3-SFP tab

6.10.17 Changes for the Enterprise Edition

The EE version has most of the features of the Service Provider Edition, except for the following:

6.10.17.1 Customer Management is Removed

In the Tools menu the option Customer Management is removed. Refer to the following figure:

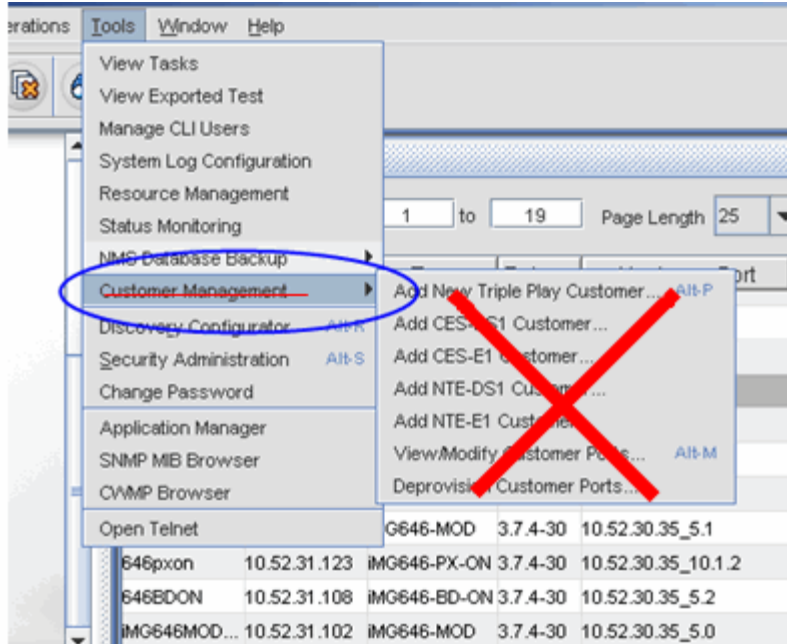

FIGURE 6-75 Enterprise Edition - No Customer Management Option

6.10.17.2 Cannot Provision / Deprovision Customer Port from Inventory View

The right-click menu in the ports table does not include the Provision and Deprovision Customer/Port. Refer to the following figure.

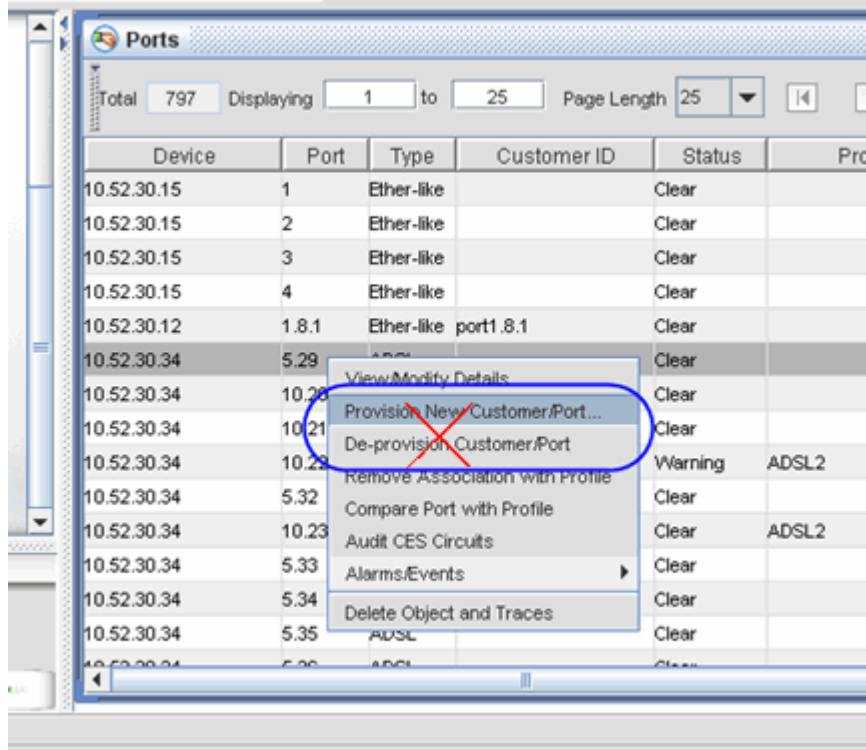

FIGURE 6-76 Enterprise Edition - Cannot Provision Customer Ports from Port Table

6.10.17.3 Cannot Provision / Deprovision iMG / RG (or run MPEG Test)

When right-clicking on the iMG/RG in the NMS inventory table, the options to provision or deprovision an iMG/RG, as well as run an MPEG test on the iMG/RG, are not available. Refer to the following figure.

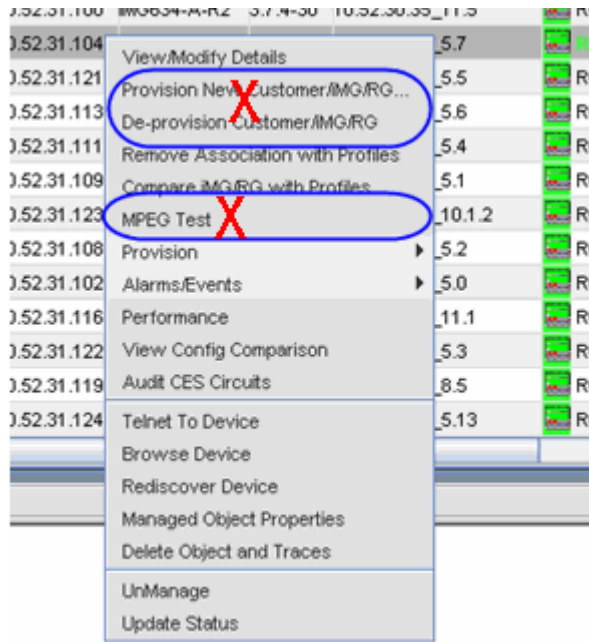

FIGURE 6-77 Enterprise Edition - Cannot Provision iMG/RG

6.10.17.4 Cannot Provision / Deprovision Customer Port in Port Management Window

In the Port Management window, the buttons for provisioning / de provisioning a customer port are removed, with only the button Port available. Refer to the following figure.

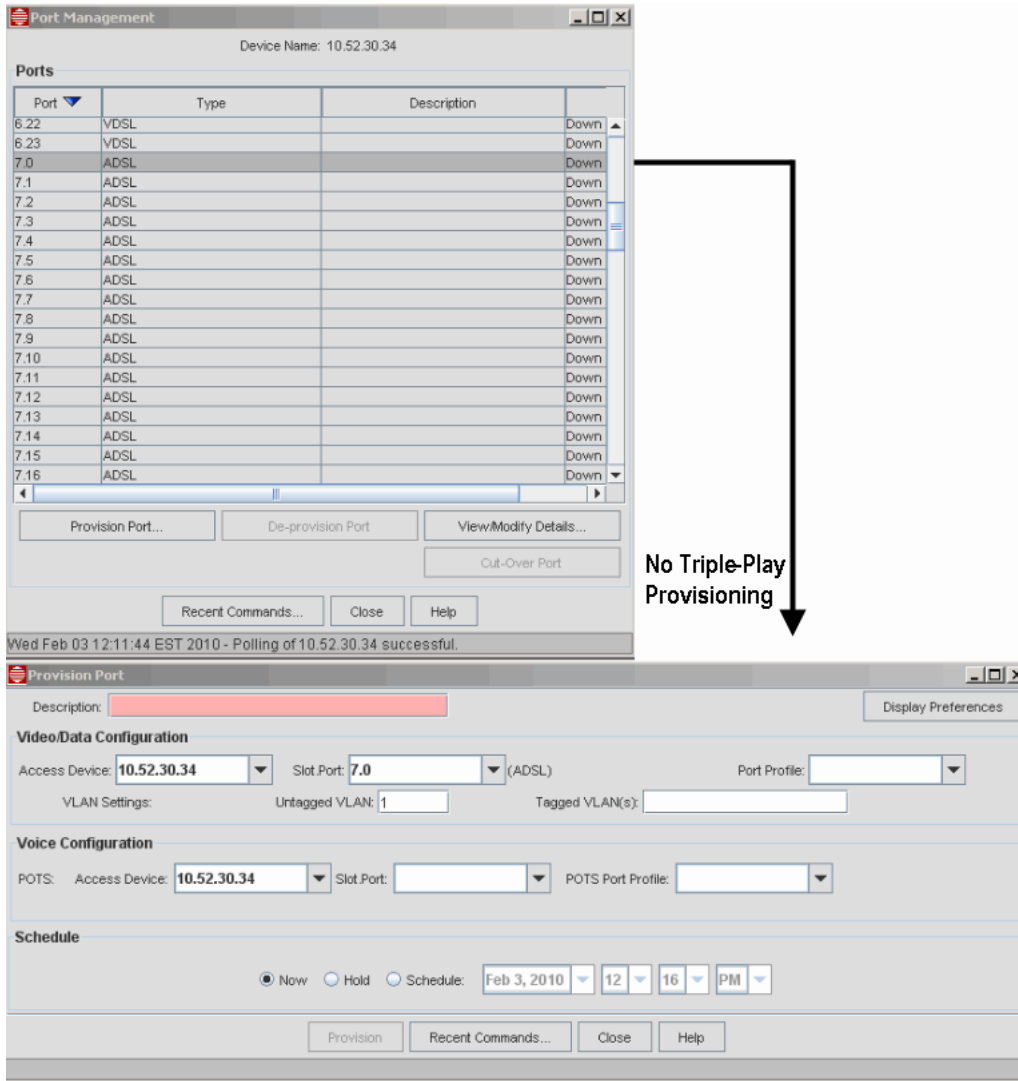

FIGURE 6-78 Enterprise Edition - Port Management

6.10.17.5 No CPE Services Profiles Menu Option

For the menu item Network Services - Profile, the CPE Services Profile menu item will not be available, since creating new iMG/RG profiles will not be allowed. Refer to the following figure.

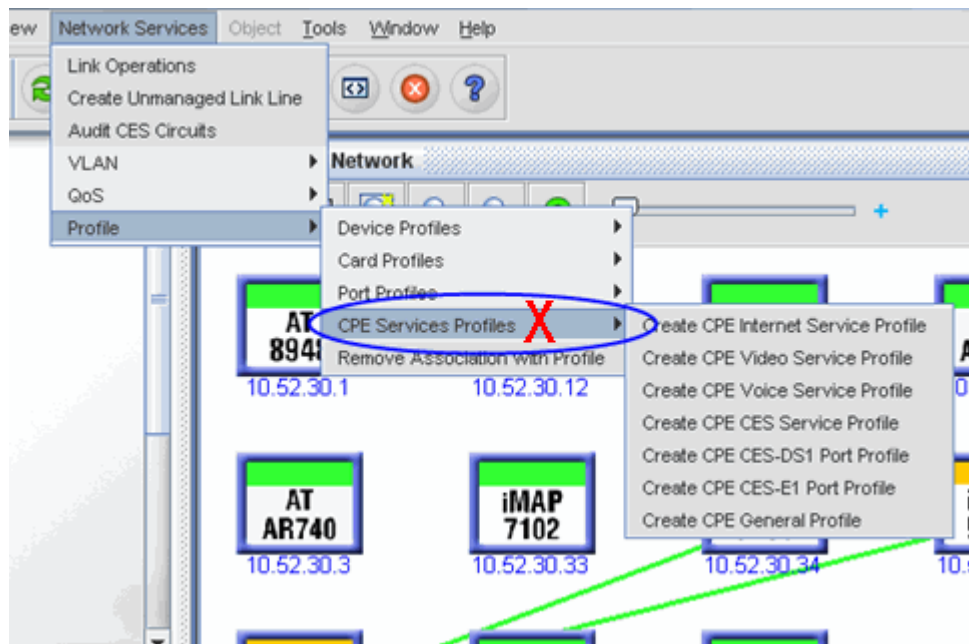

FIGURE 6-79 Enterprise Edition - Profile Creation (not for iMG/RG)

Note: Even though the EE version will block access to creating CPE profiles and using the Triple Play application for provisioning customers, existing profiles can be deleted, and configurations can be applied to iMGs/RGs using the View Details panel.

6.11 Quality of Service (QoS) Network Management

6.11.1 Overview

Configuring QoS capabilities on the various iMAP device types is fairly detailed and complex. Since the same QoS configuration is often applied across multiple devices, it is convenient for the network manager to define **QoS Policies** (configuration information) in the NMS and then separately deploy the policies to a specific set of devices and their ports.

The QoS Configuration feature interacts with the Profile Management Feature (see 6.10), particularly with respect to activation of QoS Policies. The Profile Management Feature manages Port Profiles which include references to the QoS Policies that are to be associated with a device port.

Note: There are also Device Policies that allow for the setting of switch-wide QoS parameters to a set of devices.

The following table lists the major areas for configuring traffic management and should help the user find the appropriate information or task.

TABLE 6-9 Task List for Traffic Management

Task	Screen / Form Name (if Applicable)	Section
Overview of Traffic Management Concepts		(6.11.1.1)
Review of parameter associations	iMAP MAP components	(6.11.1.2)
QoS Traffic Flows	QoS Policy Flow Dialog	(6.11.2)
QoS Priority Action	QoS Priority Action Form	(6.11.3)
QoS Traffic Action	QoS Traffic Action Form	(6.11.4)
QoS Policy Action	QoS Policy Action Form	(6.11.5)
QoS Policy Maintenance Window	QoS Policy Maintenance Window	(6.11.6)
QoS Policy Rule form	Edit QoS Policy Rule form	(6.11.7)

6.11.1.1 Overview of Traffic Attributes

The following concepts are used when configuring QoS using the AlliedView NMS. These concepts follow the configuration screens that make up the creation of policies and are usually filled in this order.

- **Device Class** - A class (or set) of the same type of devices. Following are the device classes:
 - Rapier
 - SwitchBlade
 - iMAP (Telesyn)
 - AT8900
 - ATRouter
 - iMAP_EPON
 - AlliedWare Plus

Since these devices classes share or do not share certain QoS capabilities, care must be taken when defining the QoS policies.

- **QoS Policy Action** - A QoS Policy Action is specifically for a Rapier or Switchblade device and involves actions that apply to all flows on the port.

- **QoS Policy Flow** - A QoS Flow refers to a sub-stream of packets on a port that satisfies a set of classification conditions. For example, a stream of packets classified by the condition that their destination TCP port is 80 (i.e., TCPDPORT=80) is considered a QoS Flow.
- **QoS Priority Action** - A QoS Priority Action is to take a QoS Policy Flow and to prioritize it according to the 802.1 VLAN priority fields or the IP DSCP/TOS fields.
- **QoS Traffic Action** - A QoS Traffic Action refers to policing/conditioning of a flow, such as limiting the maximum bandwidth or guaranteeing a minimum bandwidth.
- **QoS Policy Rule** - A QoS Policy Rule is the association of a Flow, Priority Action, and Traffic Action. To apply traffic conditioning to aggregate flows, where the individual flows have different priorities, multiple flow-priority pairs can be entered with a single Traffic Action.

Note: The NMS will only allow traffic conditioning on multiple flows if all of the Target Device Classes specified support this capability.

- **QoS Policy** - A QoS Policy is the result of combining the QoS Policy Rules into a set so that, taken as a whole, it can be applied to a port or set of ports.

Note: There are restrictions for policy names, as explained in more detail later.

6.11.1.2 Summary of Traffic Attributes for iMAP Devices

These tables summarize components for iMAP devices and their traffic management feature availability.

TABLE 6-10 Traffic Management Summary Table - DSL- and TDM-based Cards

Classifier Match Fields	SHDSL24 ^a	ADSL 24	ADSL 24AE	ADSL 24A/B ^b	VDSL 24A/B	NTE8 ^c
ETHFORMAT	X	X ^d	X ^e	X ^f	X	X
INNERVID		X	X	X	X	X
INNERVPRIORITY		X	X	X	X	X
IPTOS	X	X	X	X	X	X
IPDSCP	X	X	X	X	X	X
IPPROTOCOL	X	X	X	X	X	X
IPSOURCE	X	X	X	X	X	X
IPDEST	X	X	X	X	X	X
LSAP	X	X	X	X ^g	X	X
MACDEST	X	X	X	X	X	X
MACSOURCE	X	X	X	X	X	X
PROTOCOL	X	X	X	X	X	X
TCPFLAGS		X	X			
TCPPORTDEST	X	X	X	X	X	X
TCPPORTSOURCE	X	X	X	X	X	X
UDPPORTDEST	X	X	X	X	X	X
UDPPORTSOURCE	X	X	X	X	X	X
VID	X	X	X	X	X	X
VPRIORITY		X	X	X	X	X

TABLE 6-10 Traffic Management Summary Table - DSL- and TDM-based Cards (Continued)

Classifier Match Fields	SHDSL24 ^a	ADSL 24	ADSL 24AE	ADSL 24A/B ^b	VDSL 24A/B	NTE8 ^c
Classifier Actions						
DROP	X	X	X	X	X	X
FORWARD	X	X	X	X	X	X
COUNT	X	X	X	X	X	X
SETPRIORITY	X	X	X	X	X	X
SETIPTOS	X	X	X	X	X	X
SETIPDSCP	X	X	X	X	X	X
MOVEPRIOTOTOS		X	X		X	X
MOVETOSTOPRIO		X	X		X	X
ARP Filtering	X	X	X	X	X	X
Ingress Metering Increments	64 Kbps	1 Mbps	1 Mbps	64 Kbps	64 Kbps	64 Kbps
Egress Port Rate Limit Increments ^h						
VC Mapping to DSL Interface	1 (SHDSL16) 4 (SHDSL24)	1	1	4	1 (VDSL) 4 (ADSL)	
Peak Cell Rate Limiting (on a VC basis)	X	X	X	X	X	
Number of Egress Queues	(a)	4	4	8	8	8
Number of Classifiers	13	i	j	(h)	(h)	

- a. The SHDSL24 supports almost the same traffic features as the SHDSL16. The differences are that the SHDSL24 supports the 802.1 p-bit classifier and supports up to eight (rather than four) queues per port/vc.
- b. The PAC24A card has the same ADSL features as the ADSL24A card.
- c. The NTE8 has match rules and actions similar to the ADSL24A, except Metering (this will be added in a future release). The NTE8 is a TDM-based card.
- d. For ETHFORMAT=ANY or no ETHFORMAT, the rule will result in a match for any formats only.
- e. For ETHFORMAT=ANY or no ETHFORMAT, the rule will result in a match for any formats only.
- f. Acceptable match values for the ETHFORMAT field are ANY (which matches any Ethernet format), ETHII (along with any other match fields), and 802.3 (w/ LSAP=0xAAAA (SNAP) or LSAP=0x0F0F (NETBIOS) match rule).
- g. Only NETBIOS and SNAP values are supported.
- h. For all ADSL cards, configuration of egress rate limiting is not supported directly, but can be set using the ADSL maximum downstream rate.
- i. Classifier capacity is an approximation. The features enabled on a port or interface, such as such as IGMP, DHCPRELAY, VLAN (for per-VLAN UFO and HVLAN), EPSR, INTERFACE (TAGALL option for HVLAN), ACCESSLIST, and CLASSIFIER, classifiers on surrounding ports, content of the user classifiers, and many other factors influence the number of classifiers available on a given port or interface.

- j. Classifier capacity is an approximation. The features enabled on a port or interface, such as IGMP, DHCPRELAY, VLAN (for per-VLAN UFO and HVLAN), EPSR, INTERFACE (TAGALL option for HVLAN), ACCESSLIST, and CLASSIFIER, classifiers on surrounding ports, content of the user classifiers, and many other factors influence the number of classifiers available on a given port or interface.

TABLE 6-11 Traffic Management Summary Table - Ethernet-based Cards - iMAP and SBx3112

Classifier Match Fields	FE10/ FX10	FX20	GE2	GE3	XE1	GE4/ GE2RJ	GE8	EPON2 ^a	GE24POE	XE4
ETHFORMAT	X	X	X	X ^b	X	X	X		X	X
INNERVID	X	X		X	X		X			
INNERVPRIORITY	X	X		X	X		X			
IPTOS	X	X	X	X	X	X	X		X	X
IPDSCP	X	X	X	X	X	X	X		X	X
IPPROTOCOL	X	X	X	X	X	X	X		X	X
IPSOURCE	X	X	X	X	X	X	X	X	X	X
IPDEST	X	X	X	X	X	X	X		X	X
LSAP	X	X							X	X
MACDEST	X	X	X	X	X	X	X		X	X
MACSOURCE	X	X	X	X	X	X	X		X	X
PROTOCOL	X	X	X	X	X	X	X		X	X
TCPFLAGS	X	X	X	X	X	X	X			
TCPPORTDEST	X	X	X	X	X	X	X		X	X
TCPPORTSOURCE	X	X	X	X	X	X	X		X	X
UDPPORTDEST	X	X	X	X	X	X	X		X	X
UDPPORTSOURCE	X	X	X	X	X	X	X		X	X
VID	X	X	X	X	X	X	X	X	X	X
VPRIORITY	X	X	X	X	X	X	X		X	X
Classifier Actions										
DROP	X	X	X	X	X	X	X	X		
FORWARD	X	X	X	X	X	X	X	X		
COUNT	X	X	X	X	X	X	X			
SETVPRIORITY	X	X	X	X	X	X	X			
SETIPTOS	X	X	X	X	X	X	X			
SETIPDSCP	X	X	X	X	X	X	X			
MOVEPRIOTOTOS	X	X	X	X	X	X	X			
MOVETOSTOPRIO	X	X	X	X	X	X	X			
ARP Filtering	X	X								
Ingress Metering Increments	1 Mbps	64 Kbps	8 Mbps	1 Mbps	1 Mbps	8 Mbps	8 Mbps	c	64 Kbps	64 Kbps

TABLE 6-11 Traffic Management Summary Table - Ethernet-based Cards (Continued) - iMAP and SBx3112

Classifier Match Fields	FE10/ FX10	FX20	GE2	GE3	XE1	GE4/ GE2RJ	GE8	EPON2 ^a	GE24POE	XE4
Egress Port Rate Limit Increments	1 Mbps	64 Kbps	8 Mbps	1 Mbps	1 Mbps	8 Mbps	1 Mbps	(c)	8 Kbps	8 Kbps
Number of Egress Queues	4	8	4	8	8	4	8			
Number of Classifiers ^d	(d)	(d)	128	128	1024	128	128			
Number of Ingress Traffic Meters				63	256		127		2048	1024
Number of Ingress Traffic Counters				32	255		128		4096	16384
Number of Out-of-profile Packet Meter Counters				63	255		127		127	127

- Not the interface for traffic management; this is done by the ONU, which is the UNI interface port. The EPON2 models the ONU as an Network Access product extension.
- For ETHFORMAT=ANY or no ETHFORMAT, the rule will result in a match for either EthII or 802.3 formats.
- QoS policies (SLAs) allow limiting of services at specific rates.
- Classifier capacity is an approximation. The features enabled on a port or interface, such as such as IGMP, DHCPRELAY, VLAN (for per-VLAN UFO and HVLAN), EPSR, INTERFACE (TAGALL option for HVLAN), ACCESSLIST, and CLASSIFIER, classifiers on surrounding ports, content of the user classifiers, and many other factors influence the number of classifiers available on a given port or interface.

Usage Notes:

- Classifiers on LAGs only support filtering and remarking; not metering.
- LAGs do not support egress port rate limiting.
- Ingress Meters (TRAFFIC DESCRIPTORs) are limited to 1 per classifier. Their actions on out-of-profile packets are NCFORWARD (the default), NCDROP, an NCCOUNT.
- All interfaces support p-bit mapping to queues.
- All interfaces support only Strict Priority, Tail-drop queuing discipline.
- FE2/GE2/FE10/FX10/ADSL24 - Not supported with double tagging of 802.3 packets. Rejects classifiers with ETHFORMAT=802.3x if the classifier contains an INNERVID or INNERVPRIORITY rule. Rejects classifiers with ETHFORMAT=802.3x if the classifier contains is an HVLAN configured on that port. Any generic classifier that does not specify an EthFormat of 802.3 will NOT match 802.3 packets. In other words, classifiers with no ETHFORMAT rule or a rule of ETHFORMAT=ANY will not match 802.3 packets.
- GE3 - Not supported with double tagging of 802.3 packets. Rejects classifiers with ETHFORMAT=802.3x if the classifier contains an INNERVID or INNERVPRIORITY rule. Rejects classifiers with ETHFORMAT=802.3x if the classifier contains is an HVLAN configured on that port.
- FE2, GE2, FE10, FX10, ADSL24, GE3 - If a classifier contains a rule that specifies one of the 802.3 EthFormats, a filter will be created that will match 802.3 packets. The iMAP system assumes that if the user specifies 802.3x and IP-related fields, that this is an indicator that IP uses LLC-SNAP and as a result the system allows for an 8-byte SNAP header. The system does NOT support 802.3 headers of any size other than 8 bytes when matching IP-related fields.
- FE2, GE2, FE10, FX10, ADSL24, GE3 - Rejects classifiers containing INNERVID or INNERVIDPRIORITY rule(s) if there is NOT a HVLAN configured on that interface/port.
- FE2, GE2, FE10, FX10, ADSL24, GE3 - If a classifier fails to be installed due to any reason related to the configuration of other features on that port (such as, an HVLAN being configured on that port), the system will keep the data related to the

specified classifier. When the condition(s) preventing the classifier's installation is corrected (such as, HVLAN is removed from the port) the classifier will be automatically installed and its status will be updated at the user's CLI session.

- FE2, GE2, FE10, FX10, ADSL24, GE3 - Supports ETHFORMATs of 802.3 and EthII. Note that each of these formats consumes twice as many hardware resources as ETHFORMAT=802.3tagged, 802.3untagged, EthIItagged, or EthIIuntagged.
- Interfaces/ports configured with client-side IGMP classifiers are configured to drop IGMP router packets.
- CFC4, FE2, GE2, FE10, FX10, ADSL24 - MACs for dropped or filtered packets will appear in the Forwarding Database. They will be displayed when the SHOW SWITCH FDB command is entered.

6.11.1.3 Traffic Attributes for Rapier/Switchblade/AlliedWare Plus Devices

For detailed information on how Traffic Policies are built, go to:

<http://www.alliedtelesis.com/support/default.aspx>

6.11.1.4 Overview of Menu Selection

To create the attributes that make up QoS policies and then to associate them so that specific policies are created, the user can right click on any empty area in the Physical Network node or click on the QoS Policies leaf of the Network Service Data object and then click on Network Services of the main menu. This is shown in Figure 6-80.

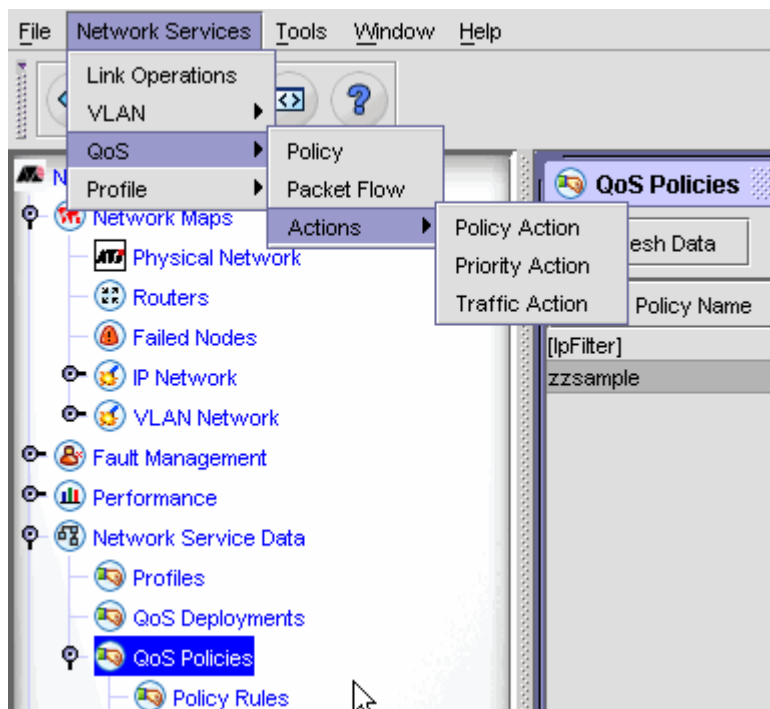

FIGURE 6-80 Accessing the QoS Policies Feature

6.11.2 QoS Flows

To create a QoS flow, a **set** of classifier conditions that is device-specific is defined and given a name. Within this set, multiple parameters can be defined, which create an “AND” condition. To add logical OR’s to the flow definition, another set of classifier conditions is added.

Table 6-12 lists the Flow conditions for the various device classes, and highlights which parameters are the same, different, or the same but with slightly different parameter names

Note: With the copy/paste of flows, there is automatic translation of parameters between devices.

TABLE 6-12 QoS Flow Conditions for Device Classes

Function	SwitchBlade	Rapier	8900	iMAP	AlliedWare Plus
Ethernet Encapsulation	ETHFORMAT PROTOCOL	ETHFORMAT PROTOCOL	ETHFORMAT PROTOCOL	ETHFORMAT	ETHFORMAT PROTOCOL
MAC Address / VLAN	DVLAN, SVLAN MACTYPE	VLAN MACSADDR MACDADDR	VLAN MACSADDR MACDADDR MACTYPE	VLANID MACSOURCE MACDEST	-
IP Address	IPDADDR IPSADDR	IPDADDR IPSADDR	IPDADDR IPSADDR	IPDEST IPSOURCE	-
IPX	IPXDADDR IPXDSOCKET IPXSSOCKET	IPXDADDR IPXDSOCKET IPXSSOCKET IPXPACKET	IPXDADDR IPXDSOCKET IPXSSOCKET	-	
Layer 4 Protocol Address and Type	IPPROTOCOL TCPDPORT TCPSPORT UDPDPORT UDPSPORT	IPPROTOCOL TCPDPORT TCPSPORT UDPDPORT UDPSPORT TCPFLAGS	IPPROTOCOL TCPDPORT TCPSPORT UDPDPORT UDPSPORT	IPPROTOCOL TCPDPORTDEST TCPSPORTSOURCE UDPDPORTDEST UDPSPORTSOURCE TCPFLAGS	IPPROTOCOL TCPFLAGS TPID INNERTPID TCPFLAGS
IPTOS / DiffServ / VLAN Priority	IPDSCP, IPTOS	IPDSCP, IPTOS	IPDSCP, IPTOS	IPDSCP, IPTOS VLANPRIORITY	IPPRECEDENCE
General Pattern Match	-	MATCH1, MASK1, OFFSET1, ...		-	-
Ingress / Egress Port	-	EPORT IPOINT		-	-

To access the Policy Flow Form, select *QoS -> Packet Flow*. Table 6-13 describes the fields. Figure 6-81 shows an example QoS Policy Flow Form.

TABLE 6-13 Options for the QoS Policy Flow Form

Option	Purpose
Target Device Classes	The device classes to be included in this Flow.
Set Targets	Brings up the Edit QOS Device Class List, allowing the user to select any combination of device classes to include. Press and Hold the SHift key to select more than one device class. Targets can also be added/removed by clicking the “Target” checkbox.
Device Class table	Table of the Device Classes, Targets, and a description of the device class. Supported indicates there are no detected errors.
Flow Name	A pull-down of all existing flows. If selected, the parameters of the selected flow appear in the form.
Device Class	A pull-down of the device classes that are included in this policy. This reflects the tic boxes chosen in the Device Class table.
New Flow	Brings up the Select New Name window. The user can choose to copy the parameters from the flow currently displayed.
Copy	Saves the parameters from the current Device Class target so they can be 'pasted' to another target device class by the “translation” feature.
Paste	Translates and applies the parameters that were “copied”. If there is no translation for a parameter it will appear with square brackets around it, and be colored red. If there is similar parameter but the value cannot be translated the value will be enclosed in square brackets and the entry will again be colored red.
Flow Classifiers	A table of the current classifiers. Delete removes the selected classifier. The Up and Down buttons change the order of classifiers (and so the logical OR), but not the selection.
Classifier #	The number of the classifier in the list. The order determines the precedence of the rules
Clear All Classifiers	Delete all classifiers in the Flow Classifier table and return to the default classifier and value (ETH-FORMAT=ANY).
New Classifier	Adds a classifier to the Flow Classifier table with the default classifier and value (ETHFORMAT=ANY). This classifier appears in the Classifier Parameter list and can be modified or replaced
Classifier Parameters	A list of the parameters for the selected classifier. If more than one parameter is listed, the Up, Down, and Delete buttons are active. The Up and Down buttons change the order of classifiers (and so the logical AND), but the order does not affect the function
Parameter pull-down and value field	A pull-down of the available parameters. As each one is selected, the associated value field appears. Values may be selected from a list of values, where each element of the list can be a Name, an Ip or MAC address, an integer range, a fixed point decimal range, or hexadecimal value. One parameter TCPFLAGS is a list of named values selected with a drop-down menu. For example, selecting VID will bring up a value field with 500, a default value. The user can then overwrite this value of 500.
Click Here to Add or Replace Parameter	If the parameter is not in the Flow Classifier table, it is added to the parameter list for that classifier (and creating another AND condition). If the parameter has already been chosen, it replaces what is already there with the new value. The available Parameters and Values change as parameters are added, reflecting the interdependencies between the parameters. For example if TCPDPORT is selected, PROTOCOL is added with a value of IP and its range is restricted to only IP
Delete Flow	Deletes the flow entry for all Target Device Classes. To remove the flow for a single Device Class uncheck its “target” checkbox. When the flow is saved the entry for that Device Class will be removed from the database.

TABLE 6-13 Options for the QoS Policy Flow Form

Option	Purpose
Save Flow	<p>If a new flow has been defined, an existing been has been changed, or targets have been removed, makes the changes permanent.</p> <p>If the parameters for some device classes are incomplete, a message box will appear with options to Fix, Skip, or Cancel. The Fix button will take you to the in error device class entry.</p> <p><i>Note: If the flow (or Action) is used by a policy that is already deployed, the Deployment Record will be marked out of sync. (Takes into account what device Classes actually changed)</i></p>
Close	<p>Closes the form. If any changes have been made a Verify Close window asks to make these changes permanent.</p>

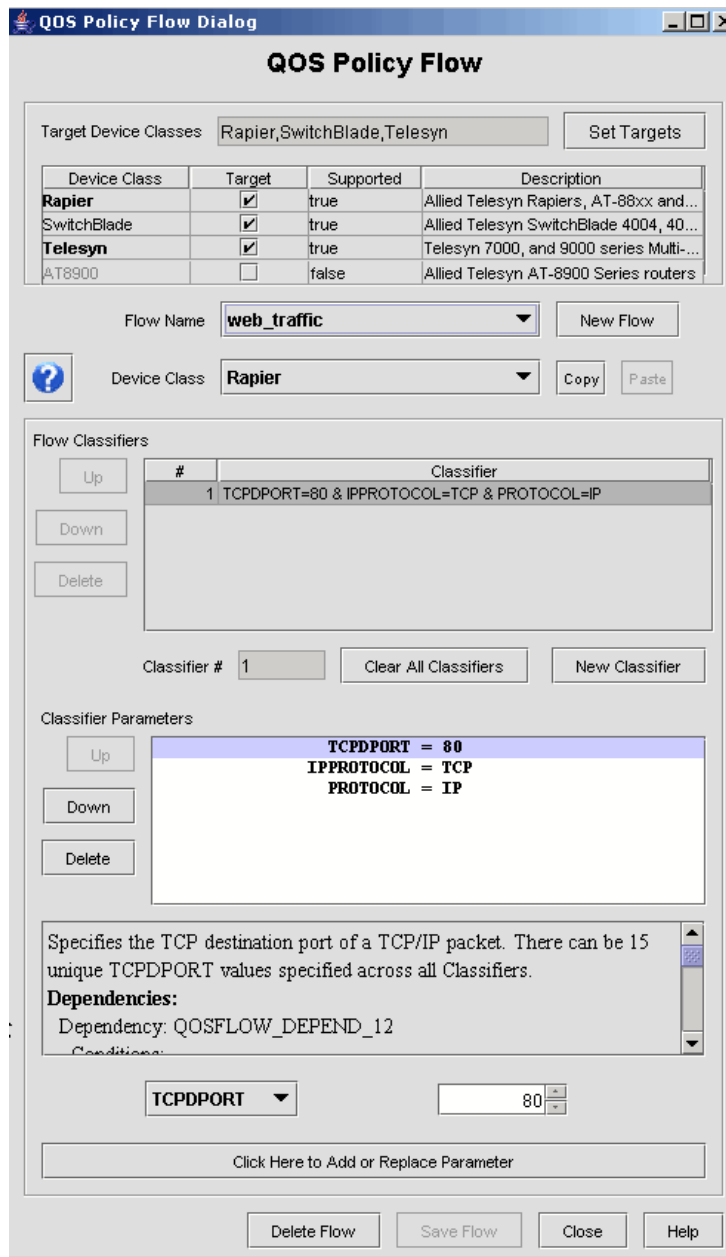

FIGURE 6-81 Sample QoS Policy Flow Form - Rapier

6.11.3 QoS Priority Action

To create a set of priority actions (which can be associated with a QoS Flow), one or more priority action parameters are defined and given a name.

Note: These parameters can be applied to one or more device classes, as long as they all support the same parameter. If they do not, an error message appears.

Table 6-14 lists the allowable actions that can be assigned to a flow. conditions for the various device classes, and highlights which parameters are the same, different, or the same but with slightly different parameter names

TABLE 6-14 QoS Priority Actions for Device Classes

Function	SwitchBlade	Rapier	iMAP	AlliedWare Plus
Remark the DSCP value at the Ingress port	-	MARKVALUE	SETIPTOS SETIPDSCP MOVEPRIOTOTOS	-
Remark the DSCP value at Egress port	MARKVALUE	-	-	DSCP
Set queue priority at Ingress port / Remark the VLAN p-bits option	-	PRIORITY REMARKPRIORITY	SETVLANPRIORITY MOVETOSTORPIO	COS
Set queue priority at Egress port / (no remark of the VLAN p-bits option)	PRIORITY	-	-	-
Drop / Forward traffic from flow (ingress port)	-	-	DROP, FORWARD	-
Traffic Statistics (Ingress port)	-	-	COUNT	-
Congestion Control (Egress Port)	RED	-	-	-

To access the Priority Action Form, select *QoS* -> *Action* -> *Priority Action*. Figure 6-82 shows an example QoS Priority Action Form. Table 6-15 describes the fields

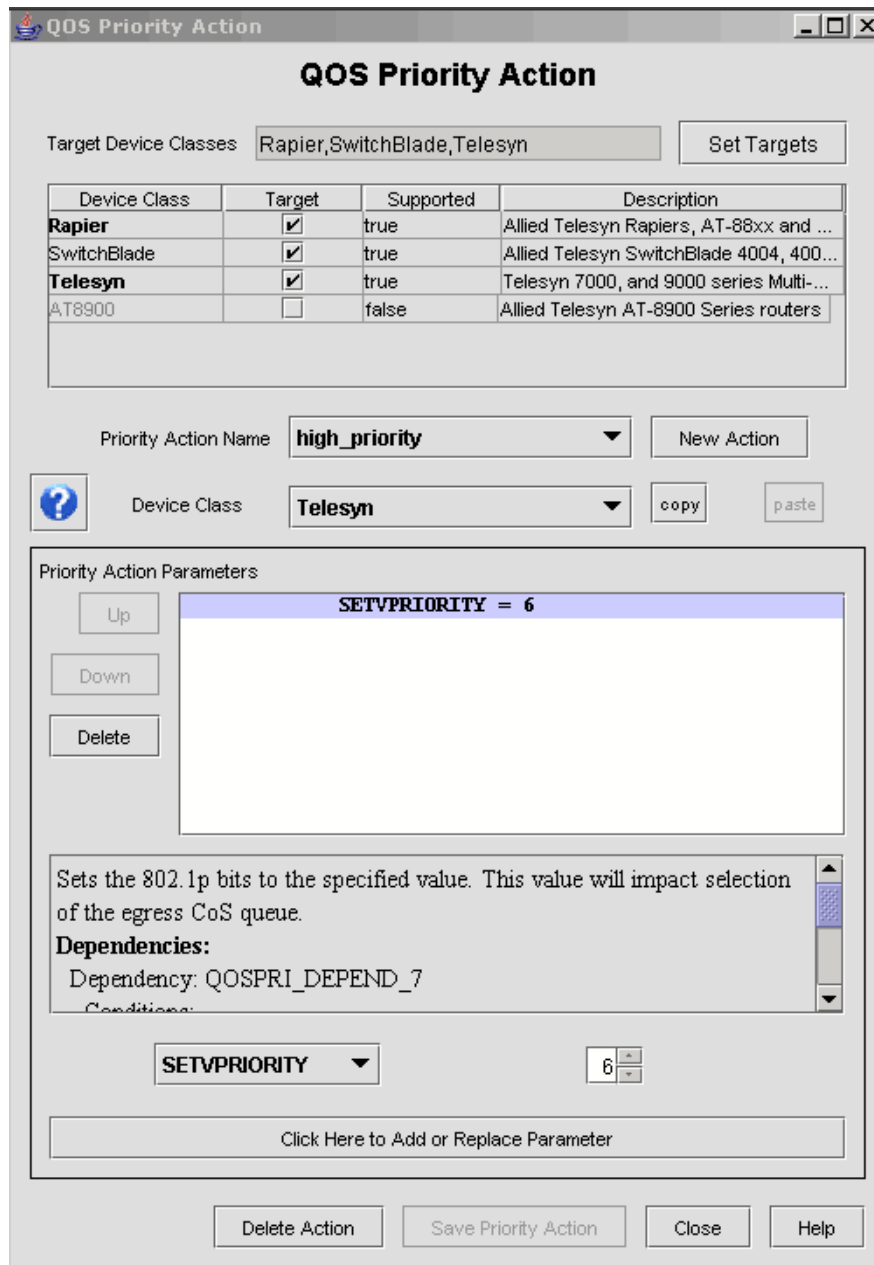

FIGURE 6-82 QoS Priority Action Form - iMAP Device

TABLE 6-15 Options for the QoS Priority Action Form

Option	Purpose
Target Device Classes	The device classes to be included in this Flow.
Set Targets	Brings up the Edit QOS Device Class List, allowing the user to select any combination of device classes to include. Press and Hold the SHift key to select more than one device class. Targets can also be added/removed by clicking the “Target” checkbox.

TABLE 6-15 Options for the QoS Priority Action Form

Option	Purpose
Device Class table	Table of the Device Classes, Targets, and a description of the device class. Supported indicates there are no detected errors.
Priority Action Name	A pull-down of all existing actions. If selected, the parameters of the selected action appear in the form.
Device Class	A pull-down of the device classes that are included in this policy. This reflects the tic boxes chosen in the Device Class table.
New Action	Brings up the Select New Name window. The user can choose to copy the parameters from the action currently displayed.
Copy	Saves the parameters from the current Device Class target so they can be 'pasted' to another target device class by the "translation" feature.
Paste	Translates and applies the parameters that were "copied". If there is no translation for a parameter it will appear with square brackets around it, and be colored red. If there is similar parameter but the value cannot be translated the value will be enclosed in square brackets and the entry will again be colored red.
Priority Action Parameters	A list of the parameters for the selected action. If more than one parameter is listed, the Up, Down, and Delete buttons are active.
Parameter Description	For the parameter chosen in the Priority Action Parameters list, a description of what the parameter is and what it does.
Parameter pull-down and value field	A pull-down of the available parameters. As each one is selected, the associated value field appears. For example, selecting SETVPRIORITY will bring up a value field with 0, a default value. The user can then overwrite this value of 1 to 7. For other parameters, such as MARKVALUE, the value field is another pull-down of the available values.
Click Here to Add or Replace Parameter	If the parameter is not in the Priority Action list, it is added. If the parameter has already been chosen, it replaces what is already there with the new value. The available Parameters and Values change as parameters are added, reflecting the interdependencies between the parameter
Delete Action	Deletes the Priority Action entry for all Target Device Classes. To remove the action for a single Device Class uncheck its "target" checkbox. When the action is saved the entry for that Device Class will be removed from the database.
Save Priority Action	If a new action has been defined, an existing action has been changed, or targets have been removed, makes the changes permanent. If the parameters for some device classes are incomplete, a message box will appear with options to Fix, Skip, or Cancel. The Fix button will take you to the in error device class entry. <i>Note: If the Action is used by a policy that is already deployed, the Deployment Record will be marked out of sync. (Takes into account what device Classes actually changed)</i>
Close	Closes the form. If any changes have been made a Verify Close window asks to make these changes permanent.

6.11.4 QoS Traffic Action Form

To define a traffic action (a condition or set of conditions that can be used on a traffic flow), one or more traffic action parameters are defined and given a name.

Note: These parameters can be applied to one or more device classes, as long as they all support the same parameter. If they do not, an error message appears.

Table 6-16 lists the allowable actions that can be assigned to a traffic action for the various device classes, and highlights which parameters are the same, different, for the same but with slightly different parameter names

TABLE 6-16 QoS Traffic Actions for Device Classes

Function	SwitchBlade	Rapier	iMAP	AlliedWare Plus
Ingress Traffic Policing - handling non-conforming traffic	-	MAXBANDWIDTH EXCEEDACTION EXCEEDREMARKVALUE	RATE BUFFERSIZE NCDROP NCFORWARD NCREMARKDSCP NCCOUNT	METER PBS
Egress Traffic Limiting / Scheduling	MAXBANDWIDTH MINBANDWIDTH FAIRHASHEDFLOWS WEIGHT STATS	-	RATE BUFFERSIZE	CBS CIR EBS EIR PBS
Congestion Control (Egress Queueing)	RED	-	-	STORMACTION STORMDOWNTIME STORMPROTECTION STORMRATE STORMWINDOW

To access the Traffic Action Form, select *QoS -> Actions -> Traffic Actions*. Figure 6-83 shows an example QoS Policy Rule Form. Table 6-17 describes the fields.

Note: For the iMAP_EPON interface, refer to 6.11.11

QoS Traffic Action

Target Device Classes:

Device Class	Target	Supported	Description
Rapier	<input checked="" type="checkbox"/>	true	Allied Telesyn Rapiers, AT-88xx and ...
SwitchBlade	<input checked="" type="checkbox"/>	true	Allied Telesyn SwitchBlade 4004, 400...
Telesyn	<input checked="" type="checkbox"/>	true	Telesyn 7000, and 9000 series Multi-...
AT8900	<input type="checkbox"/>	false	Allied Telesyn AT-8900 Series routers

Traffic Action Name:

Device Class:

Traffic Action Parameters

Up
Down
Delete

MAXBANDWIDTH = 1.000Mbps
EXCEEDACTION = DROP

Specifies the maximum bandwidth available to the traffic class. This parameter determines the maximum rate at which the ingress port accepts data belonging to this traffic class before either dropping or remarking occurs.

MAXBANDWIDTH Mbps

FIGURE 6-83 QoS Traffic Action Form - Rapier

TABLE 6-17 Options for the QoS Traffic Action Form

Option	Purpose
Target Device Classes	The device classes to be included in this Traffic Action.
Set Targets	Brings up the Edit QOS Device Class List, allowing the user to select any combination of device classes to include. Press and Hold the SHift key to select more than one device class. Targets can also be added/removed by clicking the “Target” checkbox.
Device Class table	Table of the Device Classes, Targets, whether the parameters chosen are supported by the device class, and a description of the device class.
Traffic Action Name	A pull-down of all existing Traffic Actions. If selected, the parameters of the selected action appear in the form.
Device Class	A pull-down of the device classes that are included in this policy. This reflects the tic boxes chosen in the Device Class table.
New Action	Brings up the Select New Name window. The user can choose to copy the parameters from the action currently displayed.
Copy	Saves the parameters from the current Device Class target so they can be 'pasted' to another target device class by the “translation” feature.
Paste	Translates and applies the parameters that were “copied”. If there is no translation for a parameter it will appear with square brackets around it, and be colored red. If there is similar parameter but the value cannot be translated the value will be enclosed in square brackets and the entry will again be colored red.
Traffic Action Parameters	A list of the parameters for the selected action. If more than one parameter is listed, the Up, Down, and Delete buttons are active.
Parameter Description	For the parameter chosen in the Traffic Action Parameters list, a description of what the parameter is and what it does.
Parameter pull-down and value field	A pull-down of the available parameters. As each one is selected, the associated value field appears. For example, selecting RATE will bring up a value field with 1, a default value. The user can then overwrite this value. For other parameters, such as BURSTSIZE, the value field is another pull-down of the available values.
Click Here to Add or Replace Parameter	If the parameter is not in the Traffic Action Parameters list, it is added. If the parameter has already been chosen, it replaces what is already there with the new value. The available Parameters and Values change as parameters are added, reflecting the interdependencies between the parameter
Delete Action	Deletes the entire Priority Action and its associated parameters.
Save Traffic Action	If a new action has been defined, an existing action has been changed, or targets have been removed, makes the changes permanent. If the parameters for some device classes are incomplete, a message box will appear with options to Fix, Skip, or Cancel. The Fix button will take you to the in error device class entry. <i>Note: If Action is used by a policy that is already deployed, the Deployment Record will be marked out of sync. (Takes into account what device Classes actually changed)</i>
Close	Closes the form. If any changes have been made a Verify Close window asks to make these changes permanent.

6.11.5 QoS Policy Action Form

The device classes may also have action parameters at the policy/port level. Figure 6-84 shows an example QoS Policy Rule Form. Table 6-18 describes the fields.

Note: A policy action can be created that supports an iMAP device with a “None” option.

QoS Policy Action

Target Device Classes:

Device Class	Target	Supported	Description
Rapier	<input type="checkbox"/>	false	Allied Telesyn Rapiers, AT-88xx and ...
SwitchBlade	<input checked="" type="checkbox"/>	true	Allied Telesyn SwitchBlade 4004, 400...
Telesyn	<input type="checkbox"/>	false	Telesyn 7000, and 9000 series Multi-...
AT8900	<input type="checkbox"/>	false	Allied Telesyn AT-8900 Series routers

Policy Action Name:

Device Class:

Policy Action Parameters

DTCPERCENT = 10

Specifies the percentage of port bandwidth allocated to the default traffic class for the policy.

FIGURE 6-84 QoS Policy Action Form

TABLE 6-18 Options for the QoS Policy Action Form

Option	Purpose
Target Device Classes	The device classes to be included in this Flow.
Set Targets	Brings up the Edit QOS Device Class List, allowing the user to select any combination of device classes to include. Press and Hold the Shift key to select more than one device class. Targets can also be added/removed by clicking the “Target” checkbox.
Device Class table	Table of the Device Classes, Targets, and a description of the device class. Supported indicates there are no detected errors.
Policy Action Name	A pull-down of all existing Policy Actions. If selected, the parameters of the selected action appear in the form.
Device Class	A pull-down of the device classes that are included in this policy action. This reflects the tic boxes chosen in the Device Class table.
New Action	Brings up the Select New Name window. The user can choose to copy the parameters from the flow currently displayed.
Copy	Saves the parameters from the current Device Class target so they can be 'pasted' to another target device class by the “translation” feature.
Paste	Translates and applies the parameters that were “copied”. If there is no translation for a parameter it will appear with square brackets around it, and be colored red. If there is similar parameter but the value cannot be translated the value will be enclosed in square brackets and the entry will again be colored red.
Policy Action Parameters	A list of the parameters for the selected action. If more than one parameter is listed, the Up, Down, and Delete buttons are active.
Parameter Description	For the parameter chosen in the Policy Action Parameters list, a description of what the parameter is and what it does.
Parameter pull-down and value field	A pull-down of the available parameters. As each one is selected, the associated value field appears.
Click Here to Add or Replace Parameter	If the parameter is not in the Policy Action Parameters list, it is added. If the parameter has already been chosen, it replaces what is already there with the new value. The available Parameters and Values change as parameters are added, reflecting the interdependencies between the parameter
Delete Action	Deletes the entire Policy Action and its associated parameters.
Save Policy Action	If a new Policy Action has been defined, an existing Policy Action has been changed, or targets have been removed, makes the changes permanent. If the parameters for some device classes are incomplete, a message box will appear with options to Fix, Skip, or Cancel. The Fix button will take you to the in error device class entry. <i>Note: If the Action is used by a policy that is already deployed, the Deployment Record will be marked out of sync. (Takes into account what device Classes actually changed)</i>
Close	Closes the form. If any changes have been made a Verify Close window asks to make these changes permanent.

6.11.6 QoS Policy Maintenance Window (Defining a Policy)

Once all the attributes for a QoS policy have been created, they are associated to create or define a policy which has a unique name.

Note: The names for a Policy can be up to 15 characters and should be lower case. Moreover, underscores and spaces are not allowed.

Figure 6-85 shows the QoS Policy Maintenance window. Table 6-19 explains the options.

The screenshot shows the 'QoS Policy Maintenance' window. At the top, there is a 'Target Device Classes' section with a text box containing 'Rapiert,SwitchBlade,Telesyn' and a 'Set Targets' button. Below this is a table listing device classes and their support status.

Device Class	Target	Supported	Description
Rapiert	<input checked="" type="checkbox"/>	true	Allied Telesyn Rapiers, and AT-87xx models
SwitchBlade	<input checked="" type="checkbox"/>	true	Allied Telesyn SwitchBlade 4004, 4008 and AT-98x...
Telesyn	<input checked="" type="checkbox"/>	true	Telesyn 7000, and 9000 series from Rel 2.1.0
AT8900	<input type="checkbox"/>	false	Allied Telesyn AT-8900 Series routers

Below the table are buttons for 'Test for Errors', 'Policy Name' (set to 'tripleplay'), and 'New Policy'. A 'Description' text area contains the text: 'This is a sample policy applicable to all device classes.' Below that is a 'Policy Action' dropdown set to '[Default Action]' and a 'Policy Actions' button.

The 'Policy Rules' section features a table with columns: '#', 'Flow', 'Priority', 'Traffic', and 'Target Support'. To the left of this table is a 'Row Operations' panel with buttons for 'Up', 'Down', 'Add Rule', 'Edit Rule', and 'Delete Rule'.

#	Flow	Priority	Traffic	Target Support
1	[VLAN_1]	high_priority	[No Traffic Conditio...	
2	web_traffic	low_priority	1_Mbps_limit	

At the bottom of the window are buttons for 'Analyze Rules', 'Flow Descriptors', 'Priority Actions', 'Traffic Actions', 'Reset', 'Delete', 'Save Policy', 'Close', and 'Help'.

FIGURE 6-85 QoS Policy Maintenance Window

TABLE 6-19 Options for the QoS Policy Maintenance Window

Option	Purpose
Target Device Classes	The device classes to be included in this Policy.
Set Targets	Brings up the Edit QOS Device Class List, allowing the user to select any combination of device classes to include. Press and Hold the SHift key to select more than one device class. Note that if a device class is chosen that does not support the existing rules in a Policy, an error message appears and the device class cannot be added.
Policy Name	A unique name to identify the policy. Refer to the Note above.
New Policy	Brings up a window to enter a new unique name. If this is accessed from an existing Policy, there is the option to copy the attributes from the existing policy to the new Policy.
Description	A way to provide more detail.
Policy Action	This is available for Rapier and Switchblade device classes only, and lists those that have been created.
Policy Rules table	The Policy Rules associated with the Policy. There are five columns: # - The number of the Policy Rule. Click on this to Edit, Delete, or move rules up/down. Flow - The current policy flow, which can be changed by selecting the cell. Priority - The Priority Action, which can be changed by selecting the cell. Traffic - The Traffic Action, which can be changed by selecting the cell. Target Support Flows, Priority Actions, and Traffic Actions for single flow rules can be edited directly in the table, Multi-flow rules can only be edited with the Rule Form
Analyze Rules	Goes through the defined flows and actions and applies a logic tree for the device types selected so that conflicts from a previous flow are highlighted.
Flow Descriptions	Brings up the Policy Flow Form for the selected Flow. Note that this is the standard Policy Flow Form, and so other Flows can be modified and new Flows can be created.
Priority Actions	Brings up the Priority Action Form for the selected Action. Note that this is the standard Priority Action Form, and so other Actions can be modified and new Actions can be created.
Traffic Actions	Brings up the Traffic Action Form for the selected Action. Note that this is the standard Traffic Action Form, and so other Actions can be modified and new Actions can be created.
Reset	Undo any changes that have been made by rereading the Policy from the database.
Delete	Delete the Policy and all its attributes. If the Policy has been applied to any port, an error message appears and the policy cannot be deleted.
Save Policy	Makes permanent all the changes that have been made. If the policy has already been deployed as part of Profile Management, the associated ports in the Ports table will have their Profile names marked with a "*" to indicate they are currently out-of-sync with the modified policy. To redeploy these changes, redeploy the profile as described in 6.10.

The **Analyze Rules** button follows a logic tree to highlight potential conflicts between the flows and actions for the device types. The following figure is an example.

Flow Name -Action Name	Rule Index	Telesyn
[MAPMgmt100] -[VPR17_DSCP56_Forward]	1	Effective Flow: { (VID="100" & PROTOCOL="IPV4") } Action Parameters: SETVPRIORITY=7 SETIPDSCP=56 FORWARD=
[TDM800] -[VPR16_DSCP48]	2	Effective Flow: { (VID="800" & PROTOCOL="IPV4") } Action Parameters: FORWARD= SETVPRIORITY=6 SETIPDSCP=48
[RGVoice600] -[VPR15_DSCP46_EF]	3	Effective Flow: { (VID="600" & PROTOCOL="IPV4") } Action Parameters: FORWARD= SETVPRIORITY=5 SETIPDSCP=46
[POTS700]	4	Effective Flow: { (VID="700" & PROTOCOL="IPV4") }

FIGURE 6-86 Analyze Rules Window

6.11.7 QoS Policy Rule Form

To associate a flow, a priority action, and a traffic action the QoS Policy Rule Form is used. This form is accessed on the QoS Policy Maintenance Form by clicking on the **Add Rule** button.

Figure 6-87 shows an example QoS Policy Rule Form. Table 6-17 describes the fields.

FIGURE 6-87 QoS Policy Rule Form

TABLE 6-20 Options for the QoS Policy Rule Form

Option	Purpose
Target Device Classes	The device classes that are included in this policy. This value is read-only.
Priority Action Pairs	Two pull-downs that have the available Flow Descriptions and Priority Actions. Select one from each to include in the rule. Note that each flow name can only be used once in a policy. The combo-box values for Flow Descriptor reflect this constraint.
Traffic Action	One pull-down to select the Traffic Action associated with the Flow Description/Priority Action pair.
Add	Adds the selected Flow-Descriptor pair to the Pair Table.
Add Rule	Add the rule to the Policy. The QoS Policy Maintenance form appears with the rule included.
	Up, Down, Remove, would you want these since each rule should have one of each?

Note: In using this form, the user must be aware that it is a two-step process; the user first selects the flow and priority and clicks on **Add** to add them as a Priority/Action pair. The user then chooses a traffic action and selects **Add Rule** to actually add the rule to the policy form as a row.

6.11.8 Viewing Default Flows, Priorities, Actions, and Policies

When the AlliedView NMS is first installed there is a set of flows, priorities, actions, and policies (which are made up of a combination of the these flows, priorities, and actions) that are already configured. These can be immediately used and applied to the devices and ports (and included in profiles), or used as a starting point for creating new ones. (For example, an existing flow can be brought up, and a new one can be created based on its attributes.)

Note: Names that are enclosed in square brackets, [Name], are set by Allied Telesis and cannot be changed.

6.11.9 Example of an iMAP Device Class Policy

6.11.9.1 Overview

Figure 6-88 shows a sample QoS configuration for a network, and it has the following attributes:

- The types of traffic flows are associated with specific VLANs.
- The video Head End uses the VLAN ID (VID) range of 3xx; these are then divided up into regions so that certain VLANs are configured on upstream devices that connect with an iMAP product.
- The ISP Head End uses the VID range of 5xx.
- The voice over IP gateway uses the VID range of 7xx.
- The quality of service is defined entirely through priority queueing, so classifier filters are not used.

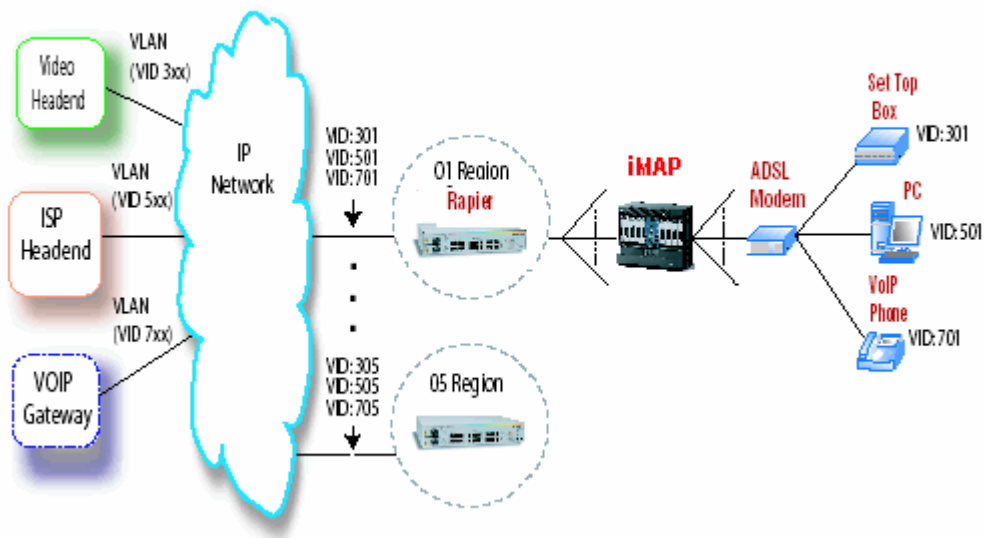

FIGURE 6-88 Sample QoS Network (iMAP MAP Device)

Table 6-21 lists the quality attributes for these classes of service.:

TABLE 6-21 Classes of Service for a Subscriber

Class of Service	Application	Delay	Jitter	Packet Loss
qos_voice	Voice	Low	Low	Low
qos_video	Video	Low	Undefined	Low
qos_data	internet access	Undefined	Undefined	Low
default	Non-critical	Undefined	Undefined	Undefined

- For qos_voice, the subscriber is set up on a VLAN with the VID 701, and the voice traffic is the only incoming stream with a VLAN tag; all other traffic is untagged and is given a tag by its port association.
- For qos_data the subscriber is set up on a VLAN with VID 501.
- For qos_video the subscriber is set up on a VLAN with VID 301, and will connect to the subscriber's Set Top Box (STB).

6.11.9.2 Creating the QoS Policy Flow

The QoS Policy Flow will be used to create the names for these flows. Following are the steps to create a flow for qos_voice:

1. Click on the Network Services menu and select *Create/Edit QoS Configuration -> Create/Edit Flows*
2. The QoS Policy Flow Dialog window appears.
3. Click on **New Flow** and enter *qos_voice* as the New Name, then **Select**.
4. The Edit QoS Device Class List appears. Select **Telesyn** only, then **Select**.
5. The default classifier (ETHFORMAT=ANY) appears in the Flow Classifiers list. Change this as follows:
 1. In the Classifier attribute pull-down, select VID
 2. A blank field appears next to VID with a default classifier number. Replace with 701.
 3. Click on **Click Here to Add or Replace Parameter**. The default Classifier is replaced with the VID=701 classifier.
6. Click on Save Flow and OK to confirm. This saves the Policy Flow name *qos_voice*, and this will appear in pull-downs of Flow Names where appropriate.
7. Repeat this and create *qos_data*, *qos_video*, and [All Packets]. When creating these, you can click on the Copy Flow *qos_voice* tic box so that the VID attribute is copied over. You then replace the VID numbers.

6.11.9.3 Creating the QoS Priority Actions

The QoS Priority Action will be used to create the names for these actions. Following are the steps to create a priority action for *qos_voice*:

1. Click on the Network Services menu and select *Create/Edit QoS Configuration -> Create/Edit Priority Actions*
2. The QoS Priority Action Form appears.
3. Click on **New Action** and enter *voice_priority* as the New Name, then **Select**.
4. The Edit QoS Device Class List appears. Select **Telesyn** only, then **Select**.
5. The default priority (FORWARD) appears in the Flow Classifiers list. Change this as follows:
 1. In the Priority attribute pull-down, select SETVPRIORITY
 2. A blank field appears next to SETVPRIORITY with a default number (0). Replace with 7.
 3. Click on **Click Here to Add or Replace Parameter**. The default Priority is added to the FORWARD action.
 4. Click on the FORWARD action and select **Delete**. Now SETVPRIORITY is the only action parameter.
6. Click on **Save Priority Action** and **OK** to confirm. This saves the Priority Action name *voice_priority*, and this will appear in pull-downs of Priority Action where appropriate.
7. Repeat this and create *data_priority*, *video_priority*, and [No Action]. When creating these, you can click on the Copy from Action *voice-priority* tic box so that the SETVPRIORITY is copied over. You then replace the SETVPRIORITY numbers.

6.11.9.4 Creating the QoS Traffic Actions

The QoS Traffic Actions will be used to create the names for these traffic actions. Following are the steps to create a traffic action *limit_voice*.

1. Click on the Network Services menu and select *Create/Edit QoS Configuration -> Create/Edit Traffic Actions*
2. The QoS Traffic Action Form appears.
3. Click on **New Action** and enter *limit_voice* as the New Name, then **Select**.
4. The Edit QoS Device Class List appears. Select **Telesyn** only, then **Select**.
5. The default actions (RATE and BURSTSIZE) appear in the Traffic Action Parameters list. Change this as follows:
 1. Rate and Burstrate parameters are initially in square brackets and colored red. This is because the default values will not work for both 7000 and 9000 devices, but the parameters are required. This keeps the user from inadvertently saving the Actions without looking at these parameters and consciously setting their values
 2. With the RATE parameter, select RATE from the pull-down. In the blank field, enter 1000.
 3. Click on **Click Here to Add or Replace Parameter**. The default RATE is replaced with the new value.

4. Repeat these steps with the BURSTSIZE parameter, selecting the pull-down 32KB.
5. In the pull-down of parameters, select NCCOUNT. The option ON or OFF appears in a pull-down. Select ON.
6. Click on **Click Here to Add or Replace Parameter**. This adds the NCOUNT parameter to the list.
6. Click on **Save Traffic Action** and **OK** to confirm. This saves the Traffic Action name qos_voice, and this will appear in pull-downs of Traffic Action Names where appropriate.
7. Since there are no other traffic actions to create for this flow, **Close** the Form.

6.11.9.5 Creating the Policy and its Rules

The policy can now be created, since it is now possible to set up the rules that make up the policy.

1. Click on the Network Services menu and select *Create/Edit QoS Configuration -> Create/Edit Policies*.
2. The QoS Policy Maintenance window appears.
3. Click on **New Policy** and enter *tripleplay* as the New Name, then **Select**. (Note that entering a name such as triple_play will bring up an error since this includes an underscore.)
4. The Edit QoS Device Class List appears. Select **Telesyn** only, then **Select**.
5. Enter a description for what the policy will do, since the name may not be descriptive enough.
6. The traffic rules can now be added. Under Row Operations, select **Add Rule**. The **QoS Policy Rule Form** appears.
7. In the Flow pull-down, which should have the default [**All Packets**], select qos_voice. In the Priority pull-down, which should have the default [**No Action**], select **voice_priority**.
8. Click on Add. This puts the flow and priority in a row and associates them. Select the Traffic Action limit_voice. with a traffic action.
9. If this is correct, select Add Rule. This will add the rule to the tripleplay policy.
10. Add rules that associate the other attributes (qos_data/data_priority, qos_video/video_priority). Each rule is defined starting with selecting the Add Rule button in Step 6
11. Select Save Policy to make the policy permanent.
12. Once the policy exists, it can be viewed by selecting the QoS Policies Tree. The Packet Flows and Actions can also be viewed by selecting their nodes.

6.11.10 Example of a Rapier/SwitchBlade Policy

Figure 6-89 shows a policy, called enterprise, that was created for a business that has the following needs:

- There is a server (CRM) in which all traffic sent from and to this server (using the IP address) has the highest priority. This is done since many business applications may involve web-based data, video conferencing, email, etc. and so all traffic types using this server will have the highest priority. There is no traffic conditioning, so all available bandwidth will be used.
- Web traffic (TCP/IP over port 80) will be handled with separate rule. When a packet comes in that is not using the IP address of the CRM server, but uses TCP/IP over port 80, it will be placed in a low priority queue (1) and set to a maximum bandwidth of 64Kbps.
- Data that does not use the CRM server IP address and is not web-based, but has a certain level of service (DSCP=55) is placed in a queue that has a priority higher than web traffic, but lower than the CRM server. It can use bandwidth up to 1Mbps, after which packets are dropped. (It is assumed that this bandwidth is sufficient for most applications.)
- All other traffic is placed in the lowest priority queue and has, like web-based traffic, a maximum bandwidth of 64Kbps. It therefore uses the same traffic action.

Figure 6-90 through Figure 6-94 shows how the forms are datafilled to define the flows, priorities, and actions.

Following are notes on using these forms:

- A flow, priority, or action can be defined first and made applicable to **all** device types. In creating a policy, the user can control which device types a flow, priority, or action will apply to.

- The user can create the flows, priorities, and actions first, and then in creating the policy create the rules that associate these together.
- The user can create a policy first, and then use the **Flow Descriptors**, **Priority Actions**, and **Traffic Actions** buttons to create new flows, priorities, and actions before defining the Rule Table.
- The **Copy** and **Paste** buttons are useful when, in defining a flow, priority, or action, the user needs to copy over the attributes to the other devices. An example would be in defining the flow CRM server; the user could define the attributes for one device type, and then copy and paste these for the other device types.

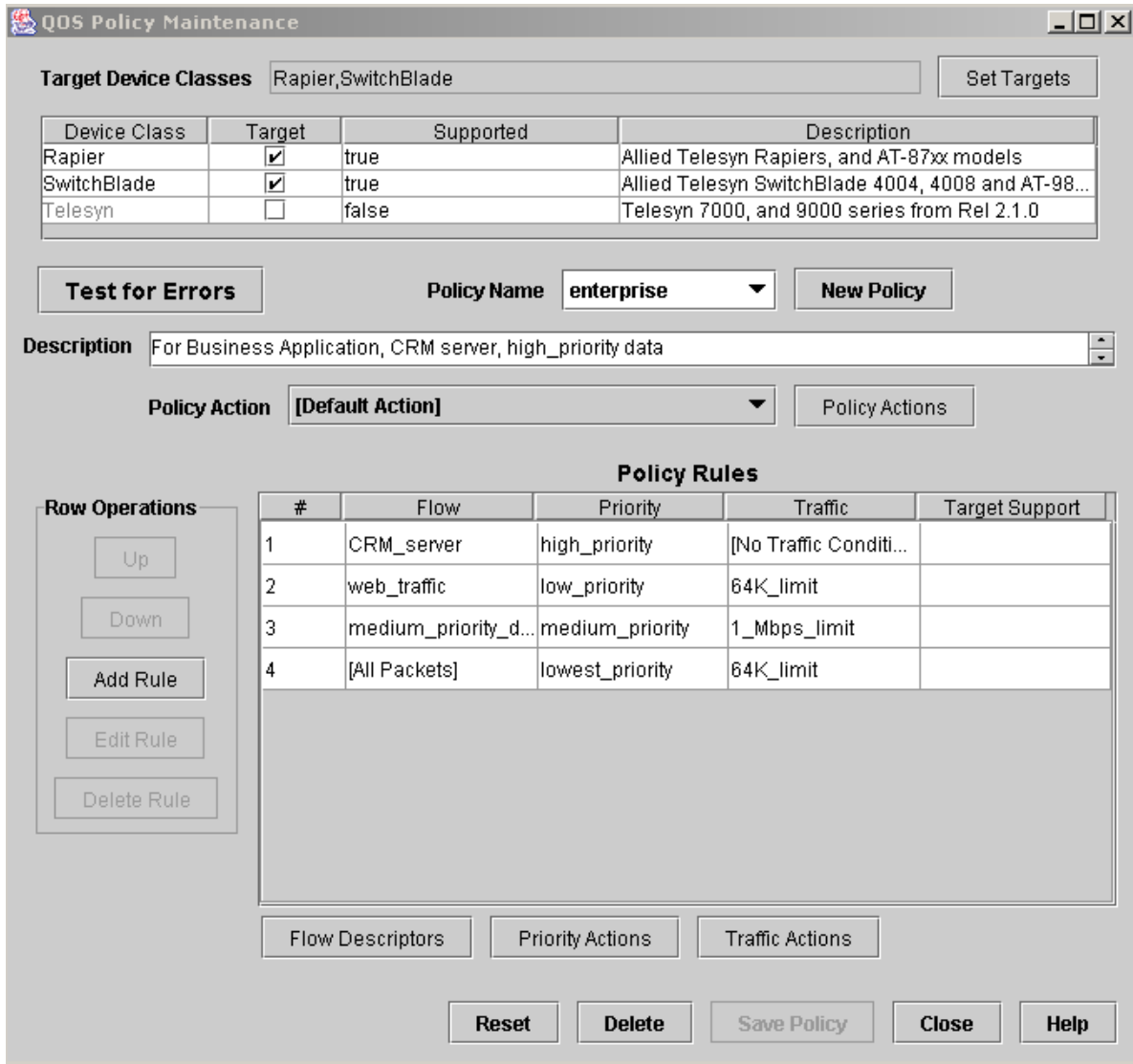

FIGURE 6-89 Example Policy for Rapiers/SwitchBlade Devices

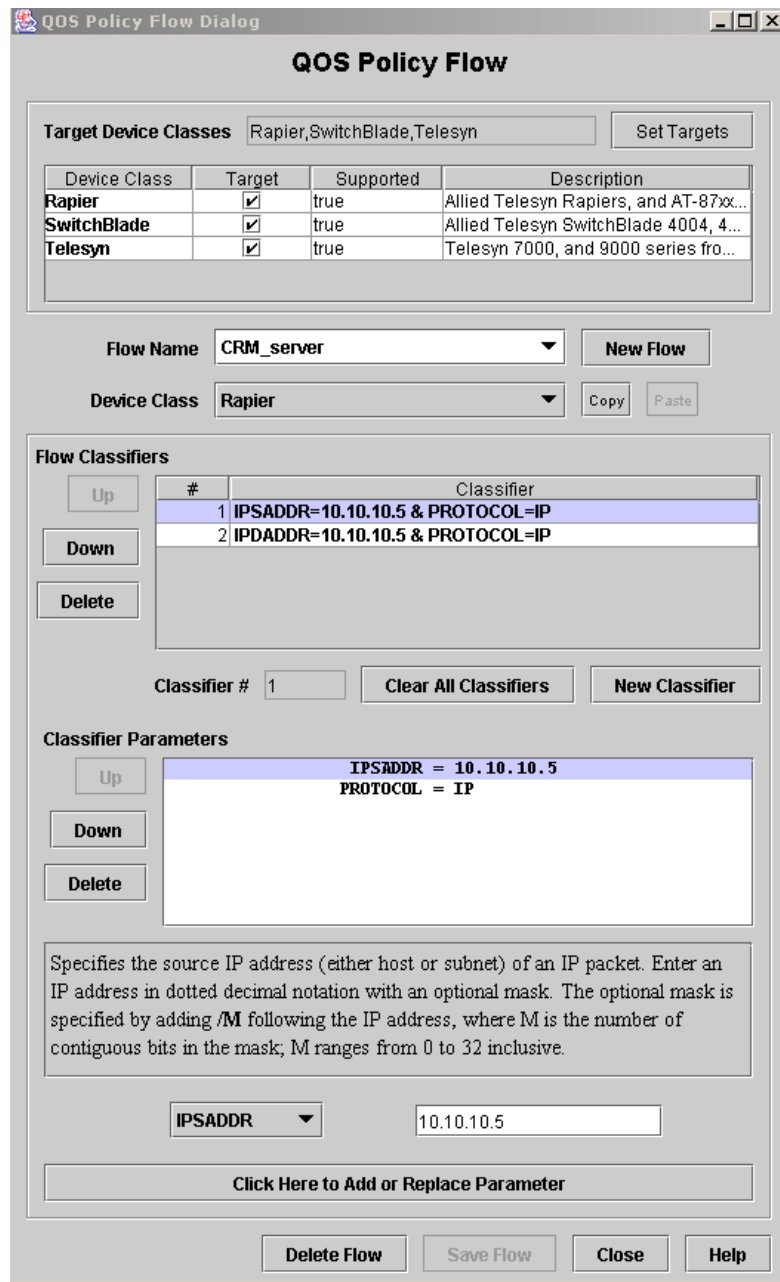

FIGURE 6-90 QoS Flow for enterprise Policy (CRM server)

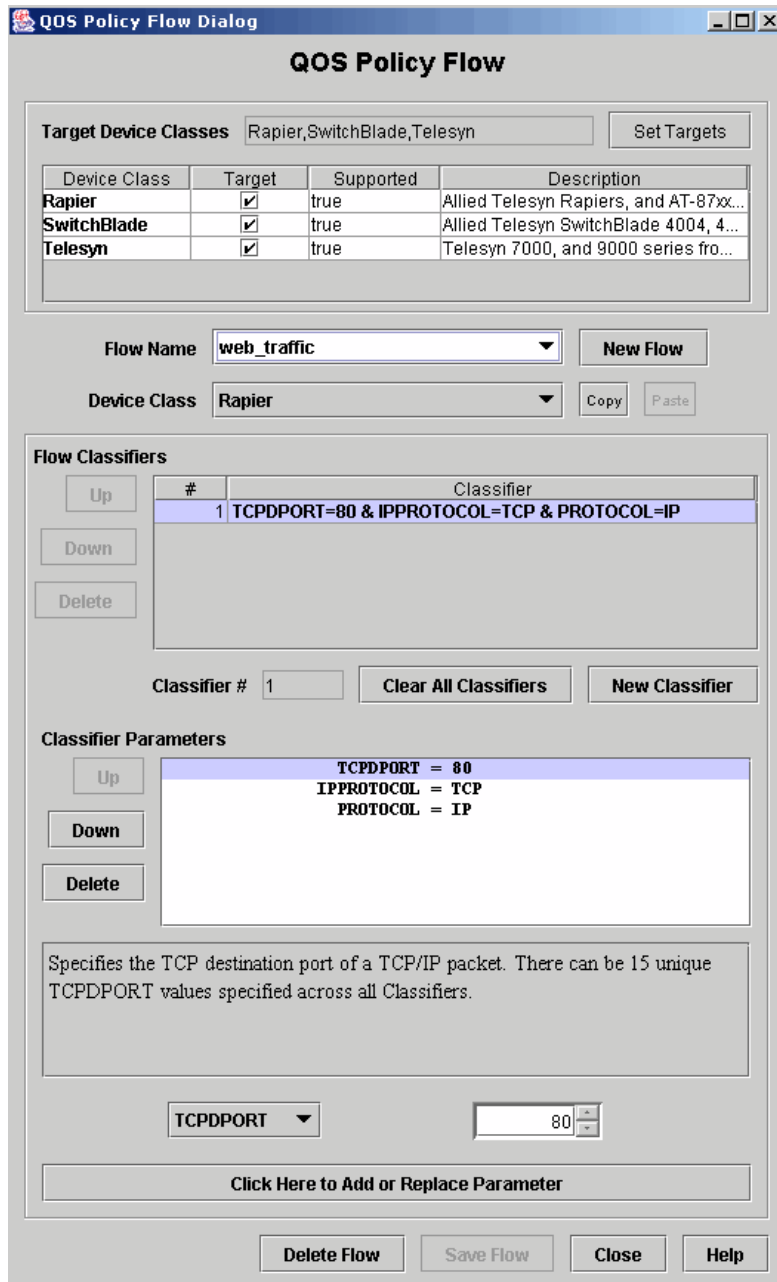

FIGURE 6-91 QoS Flow for enterprise Policy (web_traffic)

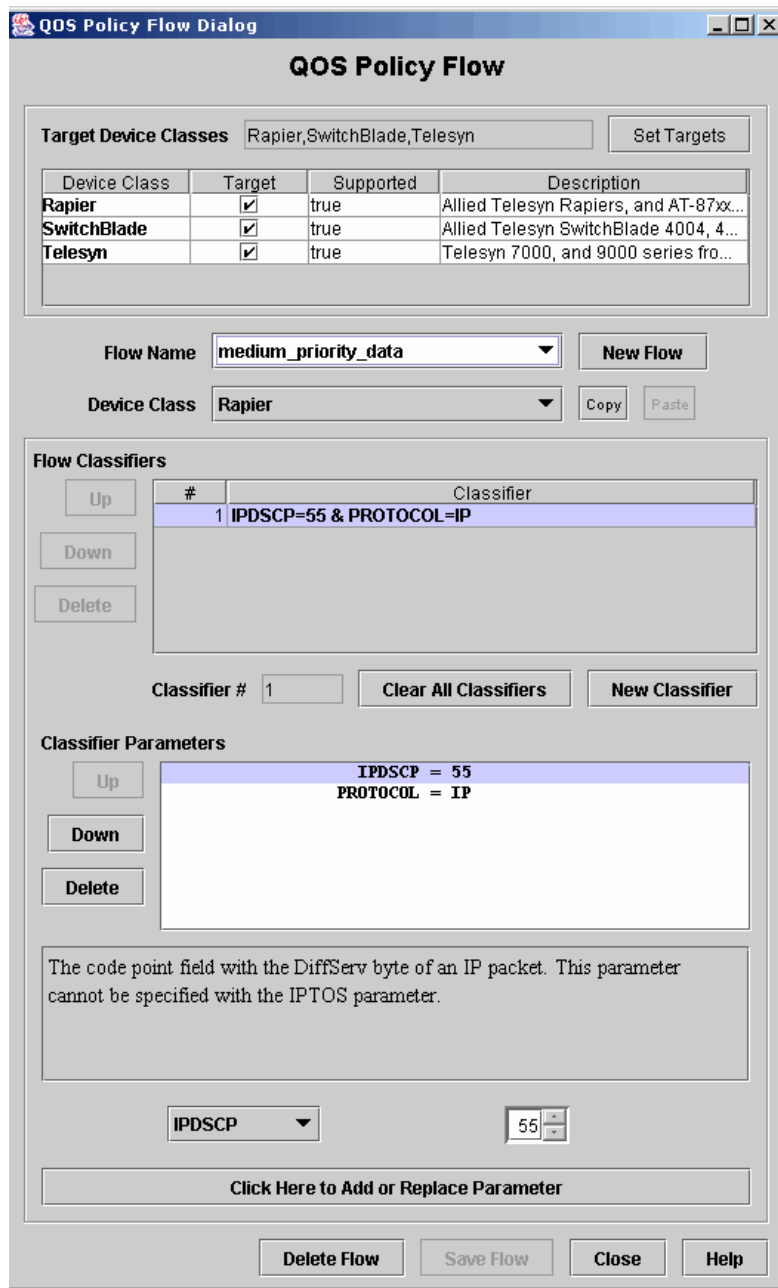

FIGURE 6-92 QoS Flow for enterprise Policy (medium_priority_data)

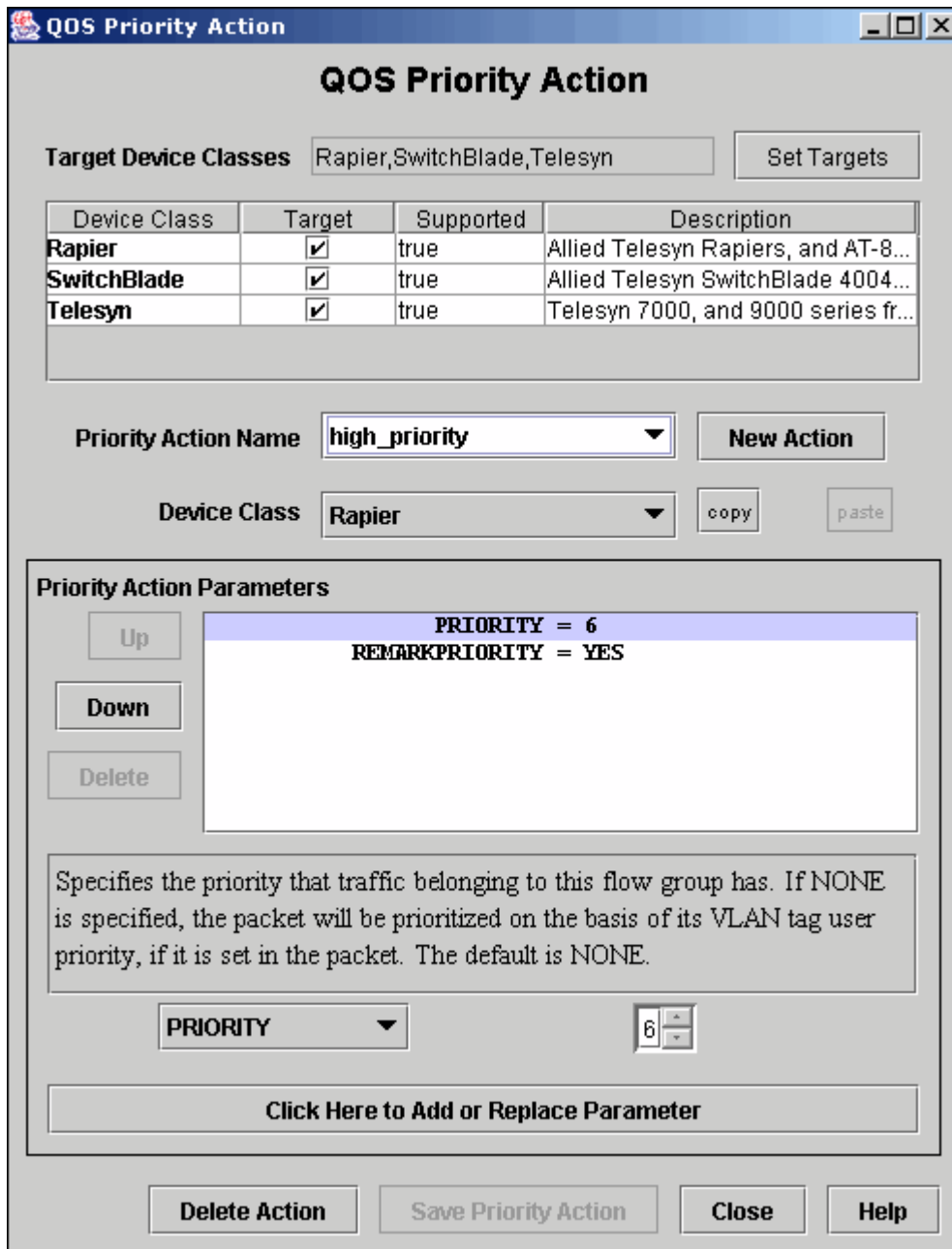

FIGURE 6-93 QoS Priority for enterprise Policy (high_priority)

QoS Traffic Action

Target Device Classes:

Device Class	Target	Supported	Description
Rapier	<input checked="" type="checkbox"/>	true	Allied Telesyn Rapiers, and AT-8...
SwitchBlade	<input checked="" type="checkbox"/>	true	Allied Telesyn SwitchBlade 4004...
Telesyn	<input checked="" type="checkbox"/>	true	Telesyn 7000, and 9000 series fr...

Traffic Action Name:

Device Class:

Traffic Action Parameters

```

MAXBANDWIDTH = 64Kbps
EXCEEDACTION = DROP

```

Specifies the maximum bandwidth available to the traffic class. This parameter determines the maximum rate at which the ingress port accepts data belonging to this traffic class before either dropping or remarking occurs.

FIGURE 6-94 QoS Traffic for enterprise Policy (64K_limit)

6.11.11 Example of an EPON/ONU Interface Policy

Creating policies for the EPON/ONU involves the same steps as creating policies for the various device types, but the administrator should understand the EPON/ONU interfaces and how policies work on these interfaces.

Note: The user should refer to the *iMAP User Guide* for complete information about provisioning the components that make up the EPON configuration.

Following are the components that make the EPON/ONU interfaces:

- EPON Interface - The EPON interface is one-to-one with the physical EPON port on the card. Like other interfaces the system can raise alarms on it, collect statistics on it, enable/disable it, etc. It will host ONU interfaces but it does not support any ETH interfaces directly.

The EPON interface is always present when the card is present (i.e. they are not created/deleted by the user). The EPON interface is identified as an interface like `epon:4.1` with the slot and physical port as the indices.

The EPON interface has IGMP-specific attributes for video multicasting:

- The VLAN for IP Multicast
- IP Source Address for IGMP Proxy (0.0.0.0 is the default; refer to the *iMAP User Guide* on using other addresses).
- ONU (Included with iMG/RG)

The ONU interface supports/hosts one (and only one) ETH interface, which is actually an Ethernet port inside the iMG/RG. The ONU interface is identified like “onu:4.1.7” with the EPON's slot and physical port as the first two indices. The last index is a logical identifier.

- SLA / QOSPOLICY (VLAN basis)

The SLA provides attributes to ensure that a traffic flow is given adequate bandwidth to support a service on an ONU. Since the service may involve downstream only or upstream/downstream data flows, the QOSPOLICY has both upstream and downstream attributes.

The QOSPOLICY is associated with a VLAN as well, and so to configure the QOSPOLICY, the user must understand the VLANs associated with a service and the traffic flows (upstream/downstream and downstream only) for each type of service.

There are two types of traffic flows on which QOSPOLICYs are configured:

1. Upstream/Downstream Links

- There is one or more per ONU
- Each one carries **one** VLAN to **one** ONU.
- Downstream, they carry known unicast packets to the ONU
- Upstream, they carry unicast, broadcast, multicast, and unknown MAC packets.
- The first one provisioned on the ONU carries some control and management traffic upstream

2. Downstream Only Link

- One is for all ONUs
- Carries two types of traffic, with each having a separately defined SLA (and therefore QOSPOLICY)
 - Multicast traffic for only the IP Multicast (IPMC) VLAN
 - Broadcast, Unknown Unicast, and flooded Multicast (BRUUM). This downstream link is shared for all VLANs on all ONUs on the EPON.

When the AlliedView NMS is first loaded, a set of policies (with their flows, priorities, and traffic actions) are included. These profiles as well as the relevant VLAN can then be included with EPON and ONU port profiles.

The following figure shows the default profiles, followed by a table that describes the attributes of these policies.

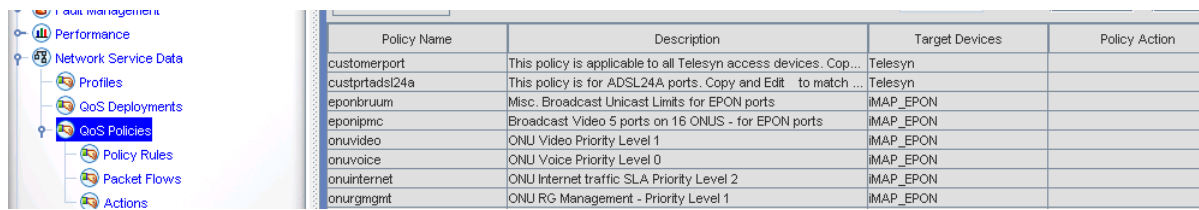

Policy Name	Description	Target Devices	Policy Action
customerport	This policy is applicable to all Telesyn access devices. Cop...	Telesyn	
custprtadsl24a	This policy is for ADSL24A ports. Copy and Edit to match ...	Telesyn	
eponbruum	Misc. Broadcast Unicast Limits for EPON ports	iMAP_EPON	
eponipmc	Broadcast Video 5 ports on 16 ONUS - for EPON ports	iMAP_EPON	
onuvideo	ONU Video Priority Level 1	iMAP_EPON	
onuvoice	ONU Voice Priority Level 0	iMAP_EPON	
onuinternet	ONU Internet traffic SLA Priority Level 2	iMAP_EPON	
onurgmgrnt	ONU RG Management - Priority Level 1	iMAP_EPON	

FIGURE 6-95 Default EPON and ONU QoS Policies

TABLE 6-22 QoS Flows for EPON Interfaces

Flow	Classifier Parameters	Notes
IpFilterFlow	IPSADDR=<ALLOWED_IPS> &PROTOCOL=IP	
onuflow	ETHFORMAT=ANY	

TABLE 6-23 QoS Actions for EPON Interfaces

Flow	Action Parameters	Notes
EPON_BRUUM	MINDOWNSTREAMRATE=1M; MAXDOWNSTREAMRATE=2M; DOWNDELAYSENSITIVITY=TOLERANT DOWNBURSTSIZE=10K	
EPON_IPMC	MINUPSTREAMRATE=0 MAXDOWNSTREAMRATE=1G; DOWNBURSTSIZE=256K DOWNDELAYSENSITIVITY=TOLERANT MINDOWNSTREAMRATE=1M;	

TABLE 6-24 QoS Actions for ONU Interfaces

Flow	Action Parameters	Notes
ONU_INTERNET	MINDOWNSTREAMRATE=0K MAXDOWNSTREAMRATE=4M DOWNDELAYSENSITIVITY=TOLERANT DOWNBURSTSIZE=5K MINUPSTREAMRATE=1M MAXUPSTREAMRATE=2M UPDELAYSENSITIVITY=TOLERANT UPBURSTSIZE=3K	
ONU_VIDEO	MINDOWNSTREAMRATE=20M MAXDOWNSTREAMRATE=512M DOWNDELAYSENSITIVITY=TOLERANT DOWNBURSTSIZE=30K MINUPSTREAMRATE=128K MAXUPSTREAMRATE=256K UPDELAYSENSITIVITY=TOLERANT UPBURSTSIZE=3K;	
ONU_VOICE	MINDOWNSTREAMRATE=512K MAXDOWNSTREAMRATE=512K DOWNDELAYSENSITIVITY=SENSITIVE DOWNBURSTSIZE=8K MINUPSTREAMRATE=512K MAXUPSTREAMRATE=512K UPBURSTSIZE=8K UPDELAYSENSITIVITY=TOLERANT	
ONU_RG_MGMT	MINDOWNSTREAMRATE=1M MAXDOWNSTREAMRATE=256M DOWNDELAYSENSITIVITY=TOLERANT DOWNBURSTSIZE=30K MINUPSTREAMRATE=1K MAXUPSTREAMRATE=64K UPDELAYSENSITIVITY=TOLERANT UPBURSTSIZE=1K	

TABLE 6-25 Default QoS Policies for EPON and ONU Interfaces

Policy	Flow	Priority	Action	Notes
eponbruum	IpFilterFlow	Allow	None	
	AnyOtherIp	Deny	None	
	AllPackets	ONUPriority	EPON_BRUUM	
eponipmc	IpFilterFlow	Allow	None	
	AnyOtherIp	Deny	None	
	AllPackets	ONUPriority	EPON_IPMC	
onuvideo	IpFilterFlow	Allow	None	
	AnyOtherIp	Deny	None	
	AllPackets	ONUPriority	ONU_VIDEO	
onuvoice	IpFilterFlow	Allow	None	
	AnyOtherIp	Deny	None	
	AllPackets	ONUPriority	ONU_VOICE	
oneinternet	IpFilterFlow	Allow	None	
	AnyOtherIp	Deny	None	
	AllPackets	ONUPriority	ONU_INTERNET	
onurgmt	IpFilterFlow	Allow	None	
	AnyOtherIp	Deny	None	
	AllPackets	ONUPriority	ONU_RG_MGMT	

With these policies, the administrator can include these with the profiles for the EPON and ONU ports.

Create Profile

Profile Name: Profile Type: EPON

Profile Attributes

Attribute New Value

IP Address:

IPMC VLAN Id (1..4094):

IP Multicast (IPMC) Policy:

Broadcast Link (BRUUM) Policy:

Statistics Counter:

Minimum Loop Length(0..60):

Copy values from profile:

FIGURE 6-96 Example EPON Port Profile

Profile Name: Profile Type: ONU

Profile Attributes

Attribute New Value

Profile Scope:

IGMP Snooping: **Enabled** ▼

Enabled DHCP Relay Instances (comma separated list):

DHCP Ageing: **Off** ▼

DHCP Filtering: **Off** ▼

Duplex State: **Autonegotiate** ▼

Speed: **Autonegotiate** ▼

Flow Control: **Autonegotiate** ▼

ONU Type: **TK3711** ▼

Max VLANs(1...6): **4** ▼

	Vlan ID	Translate VID	Qos Policy Name	Untagged
VID[=Xlate]-QosPolicy #1	<input type="text" value="7"/>	= <input type="text"/>	- onurgmgmt ▼	<input checked="" type="radio"/>
VID[=Xlate]-QosPolicy #2	<input type="text" value="10"/>	= <input type="text"/>	- onuvoice ▼	<input checked="" type="radio"/>
VID[=Xlate]-QosPolicy #3	<input type="text" value="20"/>	= <input type="text"/>	- onuinternet ▼	<input checked="" type="radio"/>
VID[=Xlate]-QosPolicy #4	<input type="text" value="40"/>	= <input type="text"/>	- onuvideo ▼	<input checked="" type="radio"/>
VID[=Xlate]-QosPolicy #5	<input type="text"/>	= <input type="text"/>	- <input type="text"/> ▼	<input type="radio"/>
VID[=Xlate]-QosPolicy #6	<input type="text"/>	= <input type="text"/>	- <input type="text"/> ▼	<input type="radio"/>
				None <input type="radio"/>

Copy values from profile: **test** ▼

FIGURE 6-97 Example ONU Port Profile

Note: The administrator can also create and view QoS policies using the CLI. When policies are created by the AlliedView NMS, they are shown at the CLI with the prefix "NMS_" added and may append an "_a" or "_b" to the name. When policies that are created at the CLI, they appear on the ONU and EPON port details screens with a question mark appended.

Note: Any existing ONU or EPON profiles have a '?' appended to the profile name. Administrators can continue to use these profiles and they will work as they did in 8.0. However, if you edit a profile or create a new one, only the 'NMS Qos Policy names' can be selected, forcing an upgrade for these Profiles.

Note: In release 10.0 SP2, the EPON supports VLAN translations. As a result, the translated VLAN ID is also included as part of setting the QoS policies.

6.11.12 QoS Policies for the FX20 Interface

6.11.12.1 Overview

The AlliedView NMS GUI for QoS allows the administrator to configure ingress traffic parameters on the iMAP ports. (Refer to 6.11.1.)

The administrator can also set the priority of traffic packets for the entire iMAP by setting the priority (usually through VLANs) and mapping them to system-wide queues before forwarding. (This is done on the NMS by creating a profile for the Allied Telesis device. By doing this, the administrator can set a queue number (0 = lowest priority; higher numbers = higher priority) and match it to the p-bit value in the packet.)

In the 11.0 release of iMAP software, there was an enhancement to provisioning egress interfaces for the FX20 interfaces; a QoS Policy, which defines data stream attributes, could be associated with a **specific queue** on the FX20 interface. This was an enhancement over other interfaces, where rate and burst attributes are defined for the entire interface (when using the attribute EGRESSLIMITER), or where a QOSPOLICY defined data stream attributes on a VLAN basis (when provisioning EPON).

On the NMS, there is already a GUI framework for creating the QoS Policies for the EPON/ONU configuration, as detailed in 6.11.11.

In NMS 11.0 SP4, this FX20 QoS feature is added; using (for the most part) the NMS GUI that is used to configure QoS Policies, the administrator can engineer traffic going through the FX20 by creating an NMS Policy that is a set of QoS Policies that tie together the queues and their data stream attributes. This policy is then included in a Profile that is for the FX20 port. The same QoS Policy can be shared with multiple ports and queues since the configuration is applied on a per port and per queue basis.

The following figure summarizes this feature. The iMG/RG is connected to the iMAP over an FX20 interface. Packets from the network have a priority based on service (usually set through VLANs), and the iMAP-level profile will map the priorities to queues. At the egress for an FX20 interface, a QoS Policy is made up of a set of rules that tie together for each queue the attributes of its data stream.

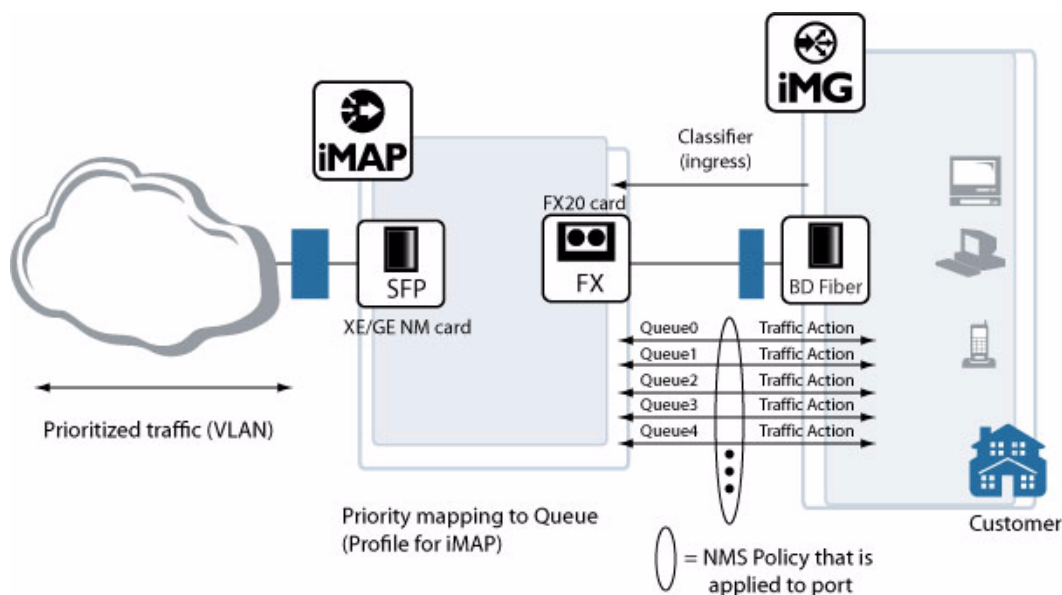

FIGURE 6-98 Summary of FX20 QoS per Queue Feature

6.11.12.2 Overview of GUI

This feature uses the GUI framework that is used to configure SLA bandwidth parameters for ONU interfaces, as detailed in 6.11.11, but instead of defining QoS Policies for each VLAN on an ONU, an NMS Policy consists of a set of rules in which each rule maps a queue to a specific traffic action. The GUI is updated as follows when creating a rule:

- QoS Packet Flow - Each flow represents a queue, and there are already in the pull-down for flows the selections for queues, [Queue0] through [Queue7].
- Traffic Priority - The rules that make up a QoS Policy for the FX20 do not use these (if the administrator chooses a Queue for a Flow, and then a Priority, the Priority will be ignored).
- Combining classifier and FX20 interface Rules - For traffic control that is not part of the FX20 interface feature, rules can still be defined for the interface. However, the same policy rule should not be used for a queue and classifiers when specifying the flow for traffic action.

6.11.12.3 Example Configuration

The following figure shows a QoS Policy that reflects the FX20 Egress Queue feature. The rest of this section shows how to configure this QoS Policy and associate it with an Ether-like port Profile.

Note: With the GUI, there are alternate ways to create the QoS Policy; this is one example.

The screenshot shows the 'QoS Policy Maintenance' window. At the top, the 'Target Device Classes' are set to 'Telesyn'. Below this is a table of device classes with checkboxes for 'Target' and 'Supported' status.

Device Class	Target	Supported	Description
Rapier	<input type="checkbox"/>	false	Allied Telesyn Rapiers, AT-88xx, AT-87xx and AT-86xx models
SwitchBlade	<input type="checkbox"/>	false	Allied Telesyn SwitchBlade 4004, 4008 and AT-98xx models
Telesyn	<input checked="" type="checkbox"/>	true	Telesyn 7000, and 9000 series Multi-Access Platforms
AT8900	<input type="checkbox"/>	false	Allied Telesyn AT-89xx, AT-99xx, AT-99xxs and x900 models
ATRouter	<input type="checkbox"/>	false	Allied Telesyn AT-AR400 Series and AT-AR750 routers

The 'Policy Name' is 'fx20queues'. The 'Policy Action' is '[Default Action]'. The 'Policy Rules' table is as follows:

#	Flow	Priority	Traffic	Target Support
1	[Queue0]	[No Action]	InetAtts	
2	[Queue1]	[No Action]	voiceFX20	

Row operations include Up, Down, Add Rule, Edit Rule, and Delete Rule. There is also an 'Ip Filter Rules' section with an 'Insert' button. At the bottom, there are buttons for 'Analyze Rules', 'Flow Descriptors', 'Priority Actions', 'Traffic Actions', 'Reset', 'Delete', 'Save Policy', 'Close', and 'Help'.

FIGURE 6-99 QoS Policy or FX20 Egress Queues

1. As mentioned in 6.11.12.2, the Traffic Flows are pre-defined and Traffic Priority is not used, so the first step is to create a Traffic Action (or set of Traffic Actions) that will be associated with the queues.

- Select *Network Services* -> *QoS* -> *Actions* -> *Traffic Action* - This brings up the QoS Traffic Action Form.

Note: You can also go to the Network Service data node and select QoS policies - Actions, and double click an existing Traffic Action.

- Select the **New Action** button, and enter the New Action Name, following the Policy naming conventions. Do not select the **Copy from ...** tic box.
- At the Edit QoS Device Class List, click on Telesyn and then the **Select** button.

- The QOS Traffic Action form appears with its list of attributes. For the FX20 queue, only four are used, so select these and edit the values.

Note: Although not necessary, you should delete the other attributes so that only the key attributes are highlighted. Refer to the following figure.

- Click on **Save Traffic Action**, and click **OK** on the confirmation window.
- Click on **New Action**, enter another Traffic Action name, and select the tic box to copy the attributes from the Traffic Action you just created. You will only need to modify the four attributes and select **Save** to save the second Traffic Action.
- Repeat these steps for each Traffic Action, up to eight.

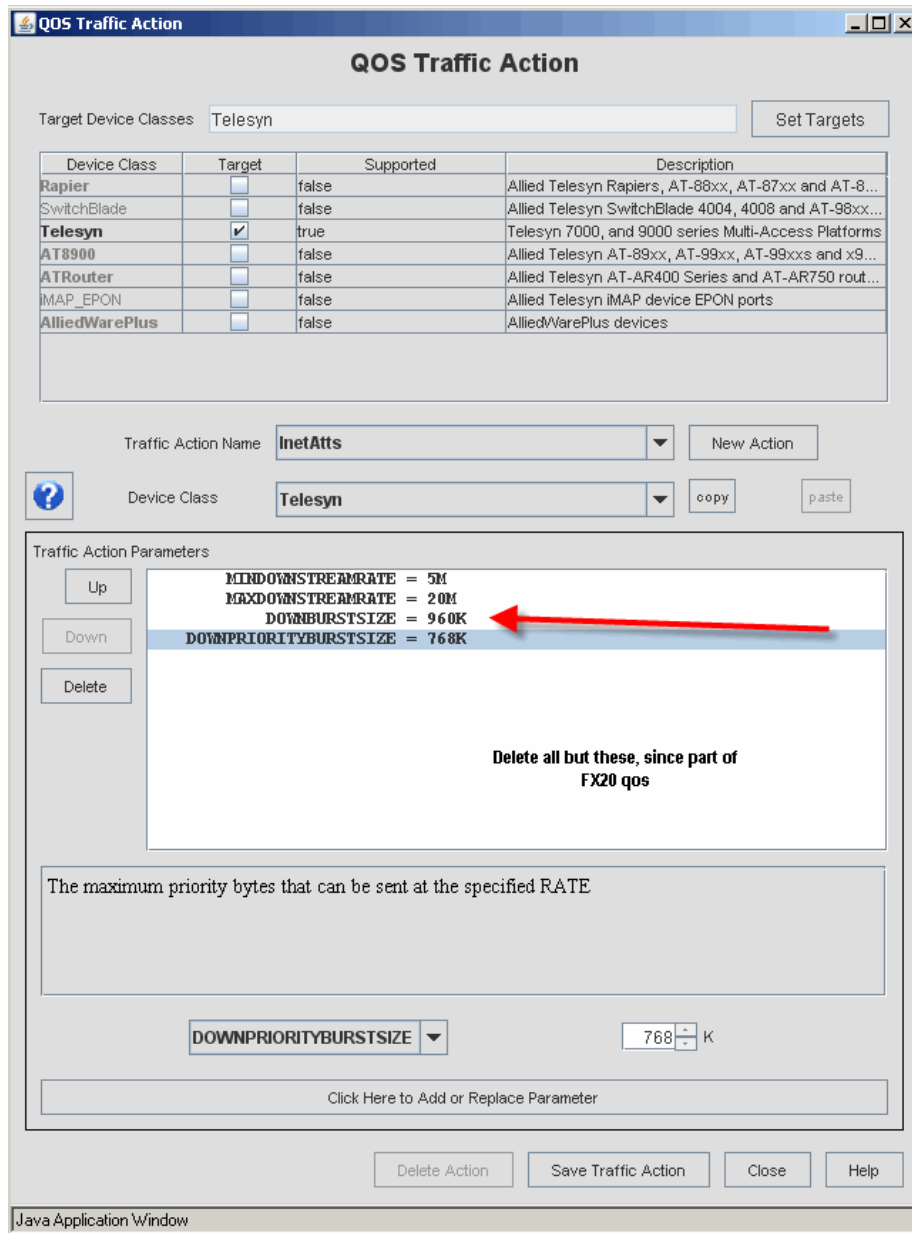

FIGURE 6-100 Creating a Traffic Action for an FX20 Interface Queue

2. With the Traffic Actions created, the QoS Policy (with its set of Rules) can be created.

- Select *Network Services* -> *QoS* -> *Policy* - This brings up the QoS Policy Maintenance Form.

Note: You can also go to the Network Service data node and select QoS policies -> Actions, and select an existing Policy

- Select the **New Policy** button, and enter the New Policy Name, following the Policy naming conventions. Do not select the Copy from ... tic box.
- At the Edit QoS Device Class List, click on Telesyn and then the **Select** button
- The QoS Traffic Policy form appears with its list of attributes. Since this is a new policy, only the two default rules appear. If they are highlighted, select **Remove** (under Ip Filter Rules), and the result is a policy with no rules. (If they are not highlighted, select a rule and select **Delete Rule**.) Refer to the following figure.

The screenshot shows the 'QoS Policy Maintenance' window. The 'Target Device Classes' is set to 'Telesyn'. A table lists device classes with their support status. The 'Policy Name' is 'fx20queues'. The 'Policy Action' is 'Default Action'. The 'Policy Rules' table has two rows highlighted in yellow:

#	Flow	Priority	Traffic	Target Support
1	[IpFilterFlow]	[Allow]	[No Traffic Conditioning]	
2	[AnyOtherIp]	[Deny]	[No Traffic Conditioning]	

Below the table, there is a 'Remove' button under the 'Ip Filter Rules' section. A red arrow points to this button. Text below the button reads: 'use Remove button to start from scratch'.

FIGURE 6-101 Creating a Policy with no Rules

3. Add the rules that will make up this policy.
 - Select **Add Rule** under Row Operations.
 - On the QoS Policy Rule Form, select the Flow as one of the pre-defined queue selections, and Traffic Action as one of the Actions that you created in Step 1. Refer to the following figure.

Edit QoS Policy Rule

QoS Policy Rule

Target Device Classes: Telesyn

Flow Descriptor - Priority Action Pairs

Row Operations: Select Flow and Priority - click Add to put in list

Add [Queue1] [No Action]

Ordered List of [Flow Descriptor - Priority Action] Pairs

Flow Descriptor	Priority Action
-----------------	-----------------

Up Down Remove

Traffic Action

Traffic Action Name: voiceFX20

Add Rule Cancel Help

Queue1 is supplied, we created Traffic Action

FIGURE 6-102 Creating a Rule for an FX20 Egress Queue

- Click on **Add**, and then **Add Rule** (there is no need to add multiple Flow Descriptor - Priority Action Pairs)
 - The Rule is added to the Policy. Click on Add Rule and repeat these steps if there are additional rules.
4. With all of the rules created, click on **Save Policy**. The QoS Policy should be similar to Figure 6-99.

5. The QoS Policy can now be incorporated into an Ether-like port profile. Refer to the following figure.

Caution: *The Profile should be given a descriptive name, such as in the figure, to help ensure that this Profile is not included on a Triple_play provisioning form for ethernet ports other than the FX20.*

The screenshot shows a 'Create Profile' window with the following details:

- Profile Name:
- Profile Type: Etherlike Port
- Profile Attributes tabs: Common (selected), iMAP, Rapier/SwitchBlade/AT8900/ATRouter, AlliedWare Plus, STP
- Attribute New Value section:
 - Profile Scoping:
 - Speed: ▼
 - Duplex: ▼
 - Flow Control: ▼
 - Max. # of Learned MAC Adrs. (None or 0..256):
 - Include VLAN Configuration in Profile: ▼
 - Untagged VLAN (1..4094 or None):
 - Tagged VLANs (comma separated list or None):
 - QOS Policy: ▼
- Copy values from profile: ▼
- Buttons:

FIGURE 6-103 QOS Policy Included with an Etherlike Port Profile

6.12 Troubleshooting Policies and Profile Management

6.12.1 Overview (QoS Deployments Table)

Since QoS Deployment has interrelationships with Profiles and Ports, there are some help procedures to understand these relationships and to use them to troubleshoot problems that may occur.

To view the status of policies, there is the QoS Deployments table, which lists the attributes of the policies and their deployment status. To access this table select *Network Services Data -> QoS Deployments*, as shown in the following figure.

Node	NMS Policy	Device Type/Rel.	Device Policy Id	Deployment Status
172.16.33.11	zsample	7700_3.0.2-00	zsample_a	policy_changed

FIGURE 6-104 QoS Deployment Status

This table is used in many of the procedures below.

6.12.2 Determine which QoS Policy is Assigned to a Port

1. Locate the port in the *Network Inventory -> Ports table*.
2. The “Profile” column will indicate which NMS Profile is assigned to the port.
3. If the Profile Name has a “*” after it, then the NMS Profile is out-of-sync with the deployed port parameters. It should be redeployed to the port so that the port is in-sync with the Profile configuration.
4. Once the NMS Profile is in-sync, locate the Profile in the *Network Services -> Profiles* table and right-click on the Profile and select the **View Profile** item.
5. The “QOS Policy” parameter will show the name of the QoS Policy that has been assigned to the port.

6.12.3 Determine Whether a QoS Policy is Deployed and In-sync on a Device

1. Locate the Node (i.e. device) and NMS Policy in the *Network Services Data -> QoS Deployments* table.
2. If there is **not** a row for this in the table, then the QoS Policy has not yet been deployed to the device. If so, go to the *Network Services Data -> Profiles* table, select/create a Profile that assigns the desired QoS Policy and right-click to deploy the profile to the desired device.
3. If there **is** a row in the QoS Deployments table associated with the Policy and device, then verify that the QoS Policy deployment is in-sync with the QoS components on the device. This is reflected in the Deployment Status column. The status should show “no_changes”.
4. To re-check that the device policy has not been recently removed, right-click on the deployment row and select **Update Deployment Status**. This will cause the NMS to go to the device and verify that the policy is still there.

Caution: QoS components on the device that are associated with an NMS policy should **not** be edited via CLI. These changes may not be detected by the NMS, in which case the status will continue to show “no_changes”. For efficiency reasons, the NMS will not attempt to re-deploy policies that are determined to be in-sync. As a result, if underlying CLI QoS component changes are suspected, you must force the NMS to redeploy the NMS policy.

To **redeploy** the NMS policy can be done in one of several ways:

- If the redeployment is only required on a single device, then right-click on the desired row of the QoS Deployment table and select **Undeploy Policy**. This will remove the corrupt QoS components from the device. At this point redeploying the port Profile will automatically update the QoS Policy on the device.

- If, on the other hand, you would like to update the QoS Policy on all devices, the simplest way to force the NMS to redeploy the policy is to modify the QoS Policy definition and resave it. This will cause all deployments of that policy to be flagged with a status of “policy_changed”, which will force all policies to be redeployed on the next Profile deployment.

After the **Update Deployment Status** operation is performed, if the Deployment Status indicates a policy or device change has been detected, then this may be the source of the problem. If so, go to the *Network Services Data -> Profiles* table, select the associated Profile that assigns the desired QoS Policy and right-click to redeploy the profile to all of its assigned ports. This will bring the devices back in-sync with the NMS Policy.

6.12.4 Determine whether a QoS Policy has the Desired Configuration

1. Locate the desired QoS Policy in the *Network Services Data -> QoS Policies* table, and right-click on it, selecting the **View/Edit Policy** item. This will bring up the details of the Policy.
2. Confirm that the Policy Rules appear as intended. You can select the **Show Errors** button to re-check for any obvious errors.
3. Analyze the Flow, Priority, and Traffic Descriptor definitions, by selecting their respective buttons at the bottom of the window. Browse through the definitions associated with the policy.
4. Review the Flows and identify any rules with intersecting flows. Different devices/interfaces handle multi-rule matches differently. Some interfaces will perform the actions only on the first rule to be matched by the incoming packet, while others will perform actions from multiple matching rules, provided the actions do not conflict with each other.

Note: Please see the device specific details for handling intersecting rules.

5. If a configuration problem is discovered, modify the QoS Policy (including any flow or action descriptors that need to be changed) to correct the problem, then save and close the window. This will flag all affected QoS Deployments to have a Deployment Status of “policy_changed”.

Since Flows and Actions may be shared among multiple QoS Policies, you may find that changes to them will affect other policies as well. These will also be reflected in the status entries of the QoS Deployments table, as explained in the next subsection.

6.12.5 Redeploying Policies

To redeploy a policy for a device or set of devices, right-click on a row of the deployment table and select **Redeploy Policy**. Refer to the following figure.

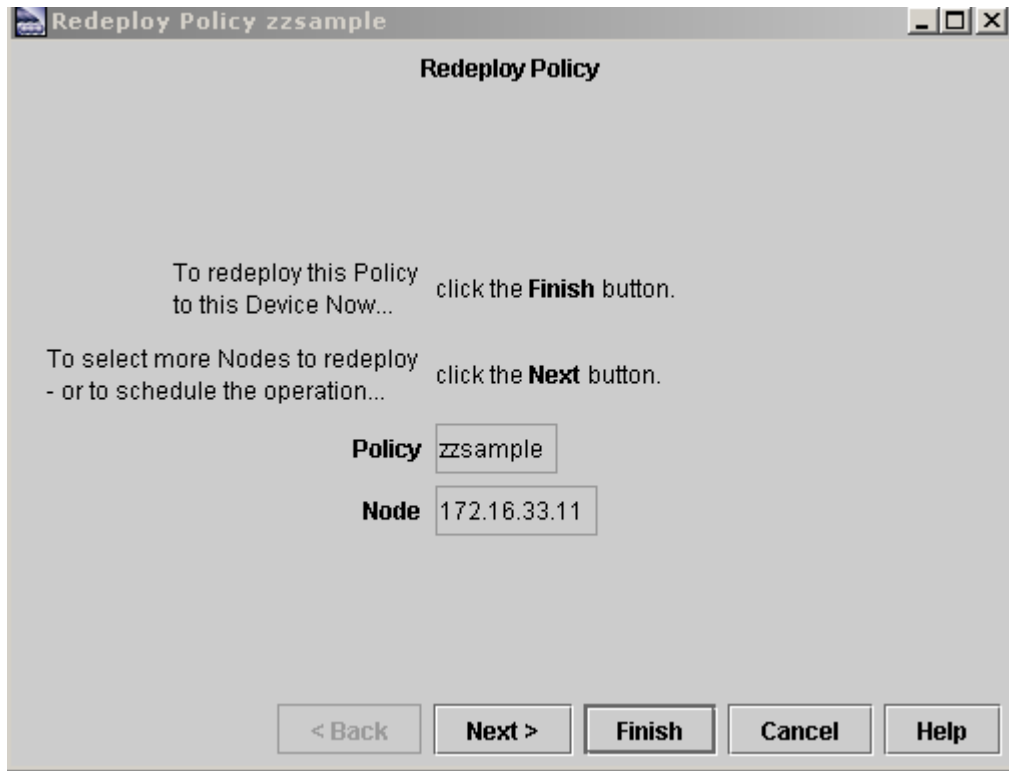

FIGURE 6-105 Redeploy Policy

Clicking on **Finish** at this point will redeploy the policy for that device. Clicking on **Next** brings up the Select Deployments form. This allows the user to redeploy a policy to the set of devices that have the policy deployed and to schedule the redeployment. Refer to the following figure.

The table includes all the devices that have the policy. One column, Status, is the relationship between the policy and the device:

- Policy Changed - The policy has changed, but the device policy does not match.
- Device Changed - The policy on the device has changed, but the policy has not changed.
- No changes - As far as what has been configured, there have been no changes.

The Auto Selection panel can be used to redeploy the policy to all the devices (by not checking any tic boxes) or selecting only those devices that are in these states (checking the tic boxes).

Selecting **Finish** starts the task immediately, while selecting **Next** will allow the task to be added to a schedule.

Note: In most situations, redeploying a policy is done more efficiently by changing the policy and redeploying the profiles that use that policy.

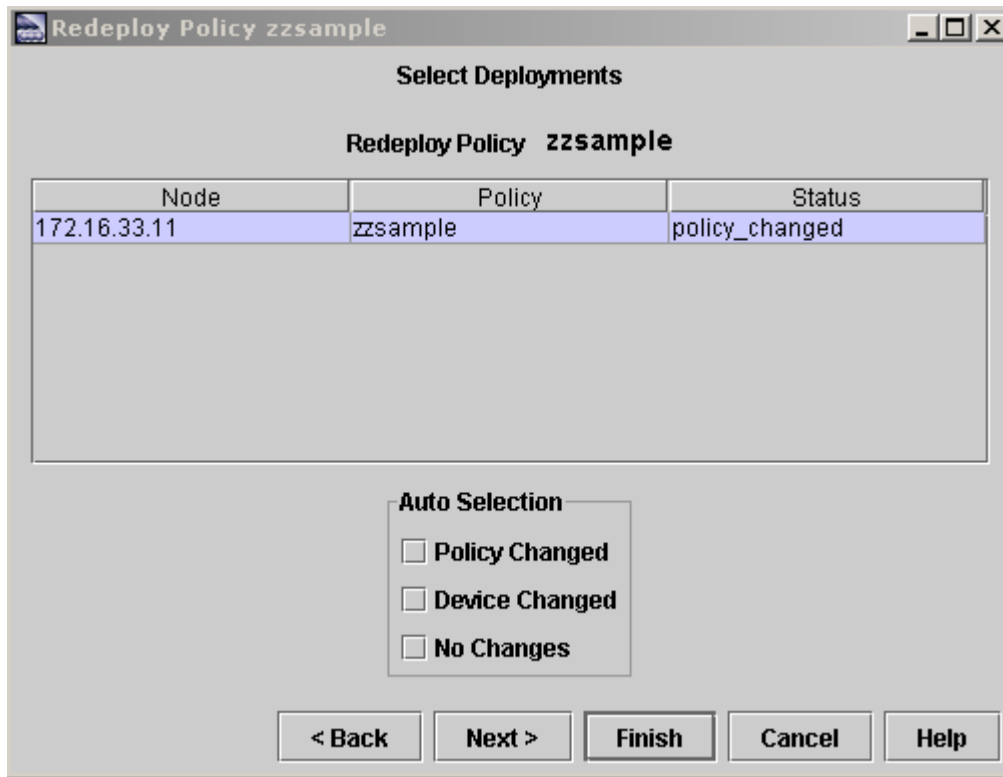

FIGURE 6-106 Select Deployments

6. For multiple devices, and to update port parameters as well, locate the affected port Profiles and use the Profiles table to redeploy to all affected devices.

6.13 Protection Switching-EPSR

6.13.1 Overview of EPSR Topology

In Ethernet-based layer 2 Metropolitan Area Networks (MAN), Spanning Tree Protocol (STP) is normally used to provide redundancy to achieve high availability and continuous access to resources. The iMAP and Allied Telesis Guides explain in detail how STP works and how it is configured.

Starting in AlliedView NMS release 4.1, the GUI can be used to configure another protection switching scheme, the **Ethernet Protection Switched Ring (EPSR)**. EPSR provides a 50 milliseconds switching time for an Ethernet-based ring network, similar to that provided by the Synchronous Optical Network (SONET) protocol. This allows traffic to be redirected around a faulty link in a ring network fast enough to result in an uninterrupted multicast service (such as video).

As the name implies, EPSR protects only those parts of the network that have a ring topology. Each node on the ring will have two Ethernet ports connected to the ring. EPSR operates over these Ethernet ports. Key components that are configured are Control VLANs, Domains, and Protected VLANs.

A **Control VLAN** is configured on the set of devices, and is used to send and receive control messages over the ring network. The devices that are included in the control VLAN make up the **Domain** of the control VLAN.

The VLANs that require fault protection are configured on all the ring ports and are assigned to the EPSR domain. These VLANs are called **Protected VLANs**.

Note: There is only one Control VLAN per EPSR domain and it must use tagged frames. This Control VLAN is unique to this domain and cannot be re-used for another domain.

Note: Control messages use the iMAP Automatic Protection Switching (TAPS) protocol. TAPS protocol control messages are transported around the ring network for an EPSR domain via its control vlan. This is handled internally by the AlliedView NMS.

The protection scheme basically operates by having an EPSR domain on the ring. The vlans that require fault protection are configured on all the ring ports and are assigned to the EPSR domain. The control ring determines if there is a loop, in which case it blocks traffic on the protected VLANs to prevent the loop. If there is no loop, it allows data traffic to flow in either direction.

6.13.1.1 Master and Transit Nodes

One of the nodes in the ring is designated as the **Master node** while all the other nodes are designated as **Transit nodes**. One ring port on the master node is designated to be the **Primary Port (PP)** and the other ring port is designated to be the **Secondary Port (SP)**.

When the ring is operating normally, the master node **blocks** its SP port for all non-control traffic (data carried over the protected vlan[s]) belonging to the EPSR domain, preventing a loop on the ring. The layer 2 Ethernet switching and learning mechanisms operate normally on each of the nodes in the ring. However, the control vlan traffic is not blocked at the SP port and is allowed to flow through, because the control messages originate either at a master node or transit node but always terminate at the master node.

When the master node detects a physical link break in the ring, it unblocks its SP port and allows the flow of non-control traffic through the EPSR domain. Once the master node determines that the break in the ring has been restored, it goes back to its normal operating procedure.

6.13.1.2 Example Ring Topologies

A typical topology has all devices (or certain ports on those devices) included in the protection domain. Moreover, each device belongs to only the one domain. However, more complex topologies are possible, as shown in the following figure.

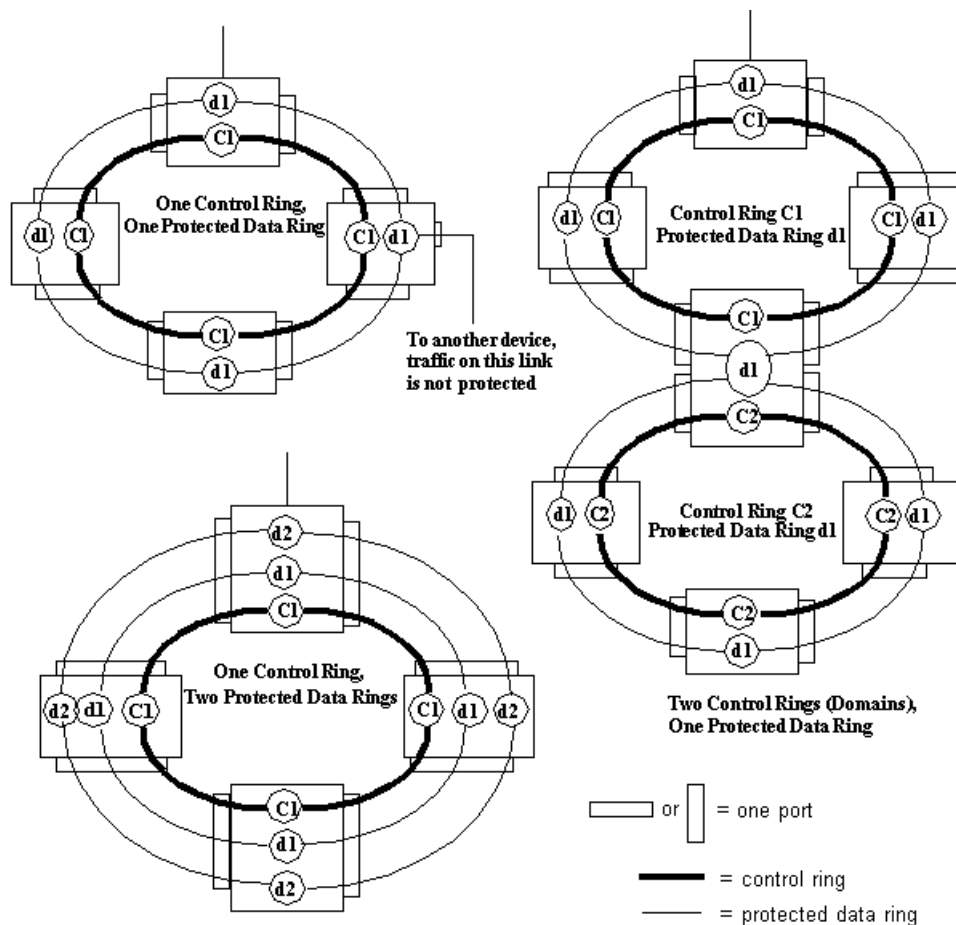

FIGURE 6-107 Example Ring Topologies

6.13.1.3 Summary of EPSSR Configuration Data

When the network administrator uses the AlliedView NMS GUI to configure an EPSSR topology, the following components are involved. These will be explained in more detail as the AlliedView NMS GUI forms are described and an example configuration is created.

- **Ring Network VLAN** - A VLAN in which the VLAN Interface in each device has two tagged linked ports, and forms a loop.
- **Non-ring Network VLAN** - A VLAN in which the VLAN Interface in each device has two tagged linked ports, and does **not** form a loop. This is a typical network VLAN, but in this case it could be part of a ring that has nodes not managed by the AlliedView NMS.
- **Protected Control Ring** - The network VLAN once it is configured with all the control VLAN attributes.
- **Protected Data Ring** - The network VLAN once it is configured with all the protected VLAN attributes.
- **Control VLAN Interface** - The unique vlan VID which will be used as the control vlan for the EPSSR domain. This VLAN is a Network VLAN and can be created as described in 6.3.1.

Note: Although the network VLAN configured as a loop can be created before configuring an EPSSR topology, it is recommended to use the Network VLAN Manager application, since it makes control Vlan's easier to create with fewer possible errors, especially since the control VLAN must be configured to form a loop.

- **Protected VLAN Interface** - The vlan VIDs which require protection on the EPSSR domain.
- **VLAN Protection Scheme** - Type of protection you wish for your data network VLANs

Note: Currently, EP SR is the only protection scheme used.

- Control Data (part of the TAPS protocol)
 - **HelloTime** – The rate at which the protocol Health control message is sent by the master node for this EP SR domain.
 - **FailOverTime** – Time for which the master node waits before declaring that it has detected a break in the ring for this EP SR domain.
 - **RingFlap Time** – The minimum number of seconds that a master node must remain in the failed state (before moving to the complete state), even if the ring has recovered from its fault condition. This delay is to limit unnecessary blocking and unblocking of the secondary port when a link in the ring is flapping (intermittently recovering from its fault). The default is 0.
- **Link Ports** – The two ports that are members of the EP SR domain.

6.13.2 The Network VLAN Manager Application - Configure Control Ring

Following are the major steps to create an EP SR configuration using the Network VLAN application. The focus will be on the screens and the fields/buttons. A more step-by-step procedure is given in 6.13.5.

6.13.2.1 Create Network VLAN

Part of configuring EP SR is creating Network VLANs that can be configured as control rings or protection rings. The procedure is the same as creating any Network VLAN, as described in 6.3.1.

6.13.2.2 Configure EPS Control Ring

There are two ways to create the control ring using the Network VLAN Manager, depending on what has already been configured:

- **Option 1** - If a Ring Network VLAN has been defined, it can be configured with an EPS protection domain.
- **Option 2** - If a non-Ring Network VLAN has already been defined, it can be extended to form an EPS control ring.

For option 1, if a Ring Network VLAN has been created, it can be configured as an EPS Control Ring by selecting the Network VLAN and choosing the **Configure EPS Control Ring..** option, as shown in the following figure.

Note: This drop-down is also available from the VLAN maps.

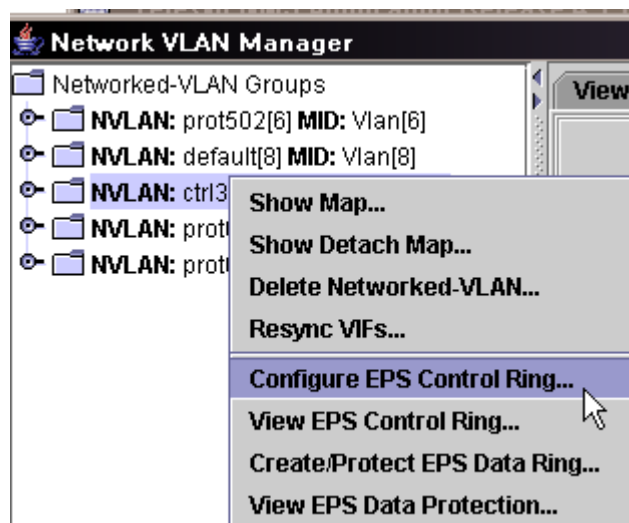

FIGURE 6-108 Pull-Down to Configure EPS Control Ring

Selecting this option brings up the Configure EPS Control Ring Panel. Click on **Create Protection Domain** to bring up the **Create New VLAN Protection Domain** dialog, as shown in [Figure 6-110](#).

Note: For AlliedWare Plus devices, which include the SB x908, x900-12X and -24X series, the Protection Domain Name can contain special characters **except** for percent sign '%'. Although Domain Name with '%' set on the device can be displayed on NMS (Network Inventory - EPSR Domain), its Status will remain Disabled and cannot be Enabled.

Note: If there are existing network VLANs on the ports that are going to be used for control ports, clicking on **Create Protection Domain** gives the following warning:

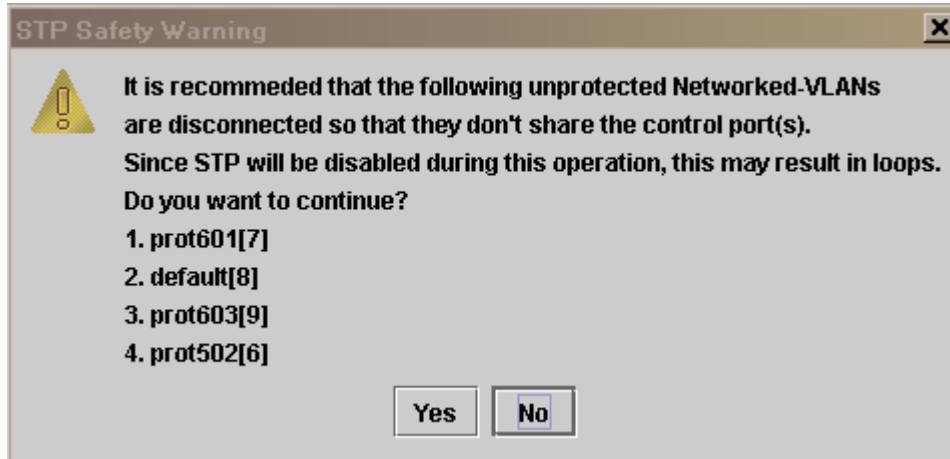

FIGURE 6-109 Warning for Creating a Control VLAN

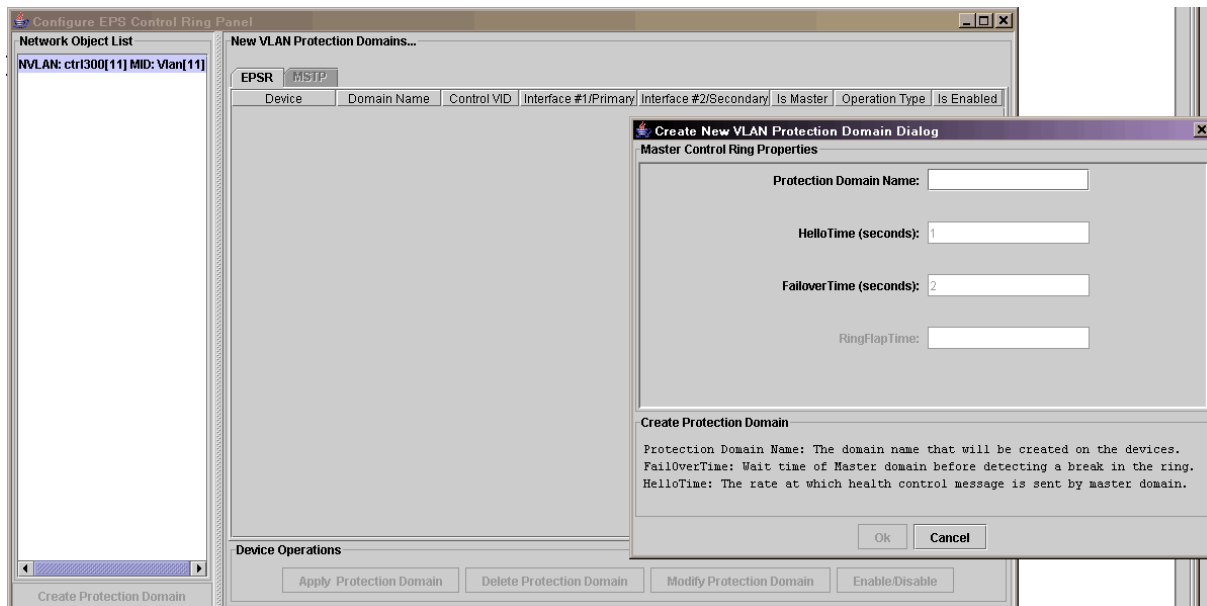

FIGURE 6-110 Configure EPS Control Ring Panel

After filling in the fields, click on **OK** to bring up the list of all EPS domains that will be configured on each device. The columns in the EPSR Protection Domain panel are filled in, as shown in the following figure.

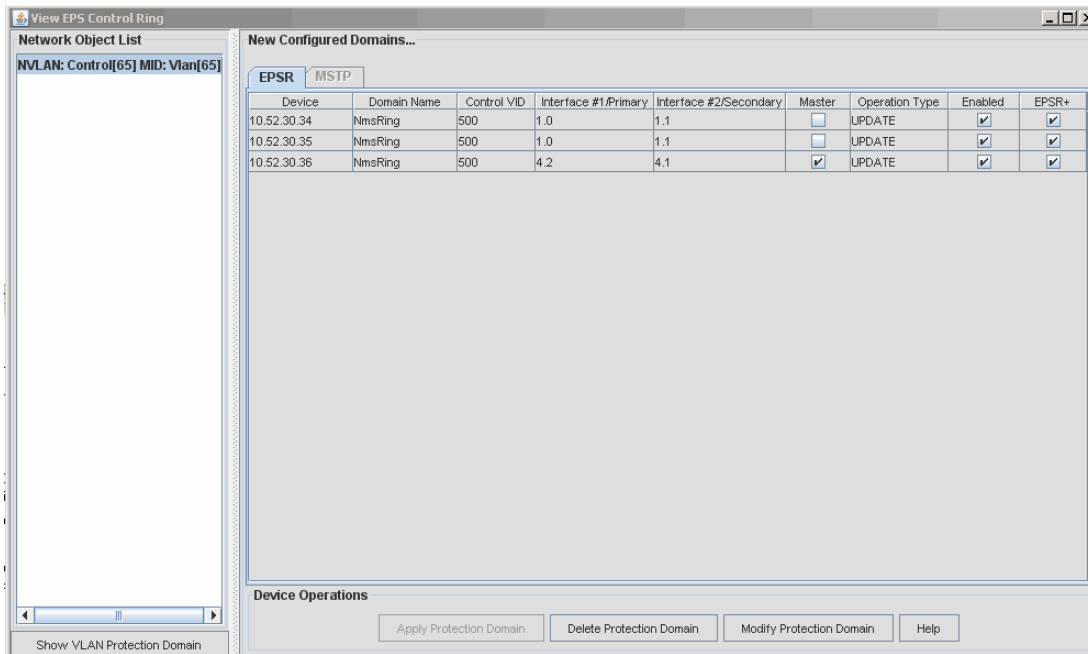

FIGURE 6-111 Creating Control Ring (Apply Protection Domain)

The user at this point can change the following attributes of the control ring (refer to [Table 6-26](#)).

- Interface #1/Primary (whichever one is chosen as the Primary)
- Is Master
- Is Enabled
- EPSSR+ - Enhanced Recovery, this is defaulted to the recommended settings, and is disabled if unavailable on the node software release.

Note: Refer to the Allied Telesis Software Manuals for detailed information about the EPSSR+ feature.

Finally, the user clicks **Apply Protection Domain**. This configures the devices to support the control ring. The Task Details window appears and the control ring is configured for each device. (If there is an error, the Task Details window can be used to determine the error condition.)

Once the Protection Domain is applied, a map of the control ring is created that can be viewed, as shown in subsection [6.13.2.5](#).

[Table 6-26](#) summarizes the fields for the Configure EPS Control Ring Panel

TABLE 6-26 Fields for the Configuration of the EPS Control Ring Panel

Option	Purpose
Network Object List	Network VLAN Object that is being used to configure the control ring. The format is: NVLAN:<name of network vlan>[ID]<MID:Vlan[ID] The ID is the way to uniquely identify the network VLAN.
Create Protection Domain	Brings up the Create New Protection VLAN Domain Dialog.

TABLE 6-26 Fields for the Configuration of the EPS Control Ring Panel

Option	Purpose
Create New Protection VLAN Domain Dialog	<p>Protection Domain - The name of the domain that will include all of the devices that are part of the Network VLAN. Naming conventions are up to 15 characters (spaces not allowed).</p> <p>Hello Time and Failover Time - Refer to 6.13.1.3.</p> <p>RingFlap Time:</p>
EP SR Protection Domain panel	<p>Lists the relevant information for the control ring: Have control over columns that are enabled. (Controllable fields in bold.)</p> <p>Device: The name of the device as defined in the Managed Object Properties</p> <p>Domain Name: The domain name that applies to this specific Network VLAN and all of its associated nodes.</p> <p>Control VID: The VID of the network VLAN that is being used to create the protection ring.</p> <p>Interface #1/Primary - Can toggle between Primary and Secondary.</p> <p>Interface #2/Secondary</p> <p>Is Master: Selects which device is to be the master node. This is usually the node that is connected to upstream devices. (This cannot be modified if you are modifying an existing control ring.)</p> <p>Operation Type: The operation (such as Create) that is being applied to the ring configuration.</p> <p>Is Enabled: Checked by default, allows the user to disable the EPS domain for that device. Note the ring (master node) should be disabled only to perform a configuration change.</p> <p>If the master is disabled, the ring will not provide protection. It appears that the device blocks both ports so it no longer is connected to the other devices (and the ring is broken).</p> <p>If the transit is disabled it also appears that the device blocks both ports for protected traffic so it no longer is connected to other devices (although the ring except for that device will still function).</p> <p>EP SR+ - Enhanced Recovery, this is defaulted to the recommended settings, and is disabled if unavailable on the node software release.</p>
Device Operations	<p>Options to perform on the created control VLAN:</p> <p>Apply Protection Domain - Configures the devices to support the control ring. Brings up the Task Details window.</p> <p>Delete Protection Domain - Activated only when the EPS Control Ring has already been created, allows the user to delete the protection domain for the network VLAN. Note that the network VLAN itself is not deleted. Refer to 6.13.2.3.</p> <p>Modify Protection Domain - Activated only when the EPS Control Ring has already been created, allows the user to modify the protection domain for the network VLAN. Refer to 6.13.2.3.</p> <p>Enable/Disable - Activated only when the EPS Control Ring has already been created, allows the user to disable the protection domain after it has been applied, and vice versa. Refer to 6.13.2.4.</p>

If **Apply Protection Domain** is chosen, the devices that use the Network VLAN are included in the Configure EPS Control Ring window, and in configuring the Control Ring the AlliedView NMS will complete the loop.

6.13.2.3 View/Modify/Delete EPS Control Ring

Once a control ring has been created, it can be viewed by selecting the relevant networked VLAN and selecting View EPS Control Ring. The View EPS Control Ring window appears, with the attributes of the control ring included in the New Configured Domains panel. Refer to the following figure.

Note: In release 12.0, the EPSSR+ field is included as well.

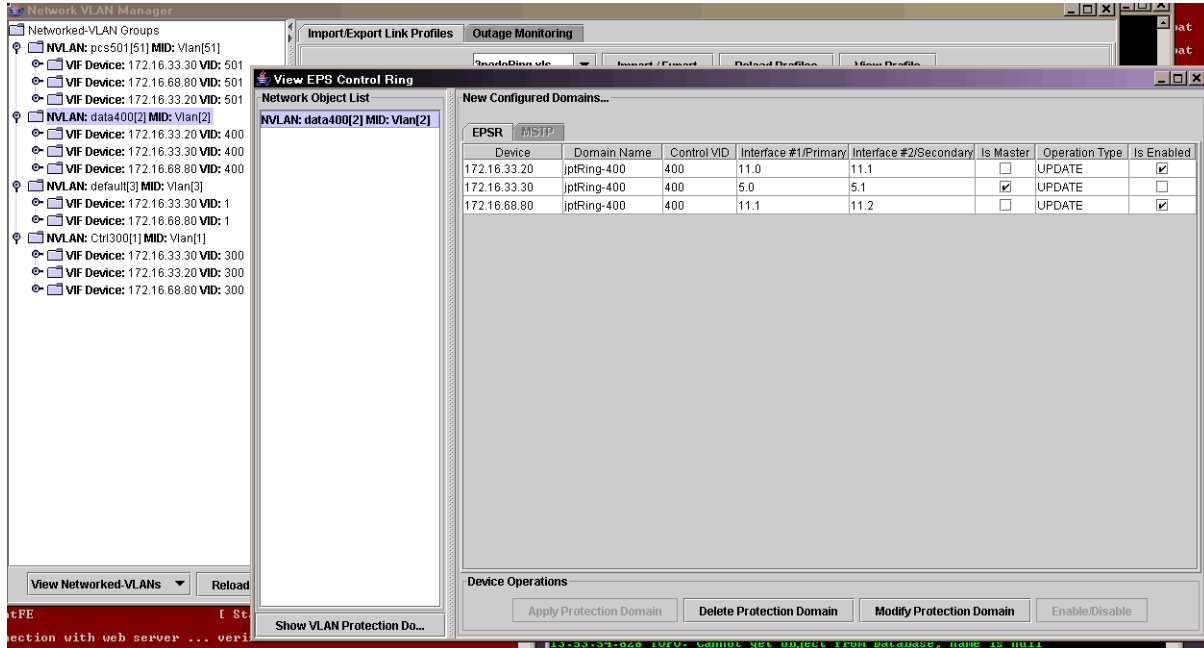

FIGURE 6-112 View EPSR Control Ring Panel

The Delete and Modify buttons are now activated. To modify the control ring, the user can choose one of the editable fields (explained in Table 6-26) and select **Modify Protection Domain**. The task list window will appear as the application changes the Control Ring attributes for each device.

To delete the control ring, the user selects **Delete Protection Domain**. After a confirmation message appears, the control ring and its attributes are deleted.

Note: The Delete Protection Domain operation deletes only the EPS domain associated with the ring, but not the Loop Networked VLAN.

6.13.2.4 Enable/Disable EPS Control Ring

Refer to Table 6-26.

6.13.2.5 Show EPS Control Ring Map

Once a valid control ring is configured, selecting the Network VLAN and right clicking on **Show (Detached) Map** brings up an icon map that shows the devices and links and their associated states. This figure can also be shown by clicking on the Network VLAN under the VLAN Network node. Refer to the following figure.

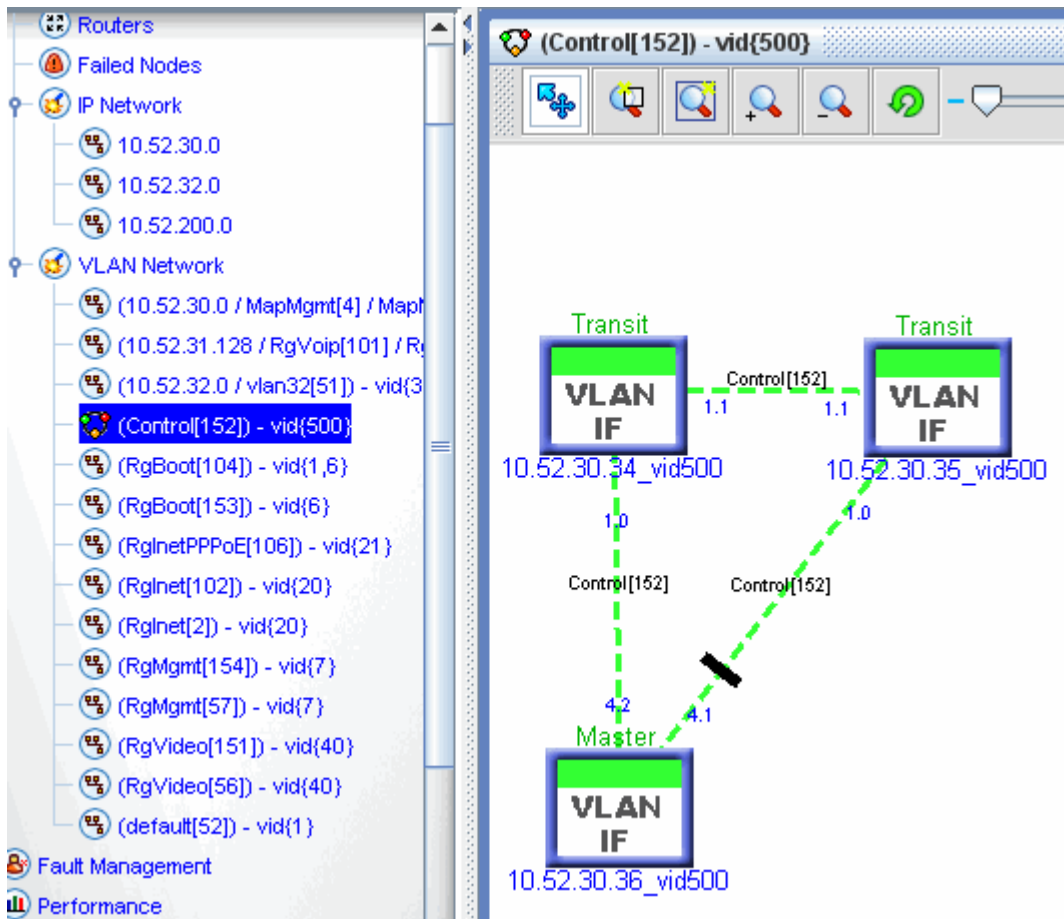

FIGURE 6-113 Control Ring Map

If a VLAN Interface (VLAN IF) has been added to an EPSSR Domain on a device, then the Vlan Map symbol for that control VLAN IF will show its Domain role, either **Transit** or **Master**, above the symbol.

The state of the EPSSR Domain is reflected in the color of the text of the domain role as follows:

For a Master VLAN IF:

- IDLE is gray (This indicates that the Domain is disabled)
- COMPLETE is green
- FAILED is red

Note: For AlliedWare Plus devices, which include the SB x908, x900-12X and -24X series, the initial state of the master node is idle (gray), and turns to green only after the associated transit nodes have been discovered. The amount of time this takes depends on the number of transit nodes that make up the ring.

For Transit VLAN IF;

- IDLE is gray (This indicates that the Domain is disabled)
- LINKS-UP is green

- LINKS-DOWN is red
- PRE-FORWARDING is orange

6.13.3 The Network VLAN Manager Application - Configure Data Ring

6.13.3.1 Create/Protect EPS Data Ring

Usually, once the EPS Control Ring is created and configured (with its domain), a new EPS Data ring is created. There are several ways to create this data protection ring, depending on what has already been configured:

- **Option 1** - If a control ring has already been defined, it can be cloned to create a new protected data network VLAN (protected data ring). The protection ring matches the ports, devices (and therefore the domain) of the control ring.
- **Option 2** - If a non-ring data network VLAN has already been defined, it can be associated with one of its possible control rings; since the data network VLAN is not a ring, the application will complete the data protection ring (and create any additional VLAN Interfaces as well).
- **Option 3** - If a ring data network VLAN has already been defined, it can be associated with one of its possible control rings and labeled as protected.

For option 1, the network VLAN that is a control ring is selected and right-clicked on **Create/Protect EPS Data Ring...** as shown in the following figure.

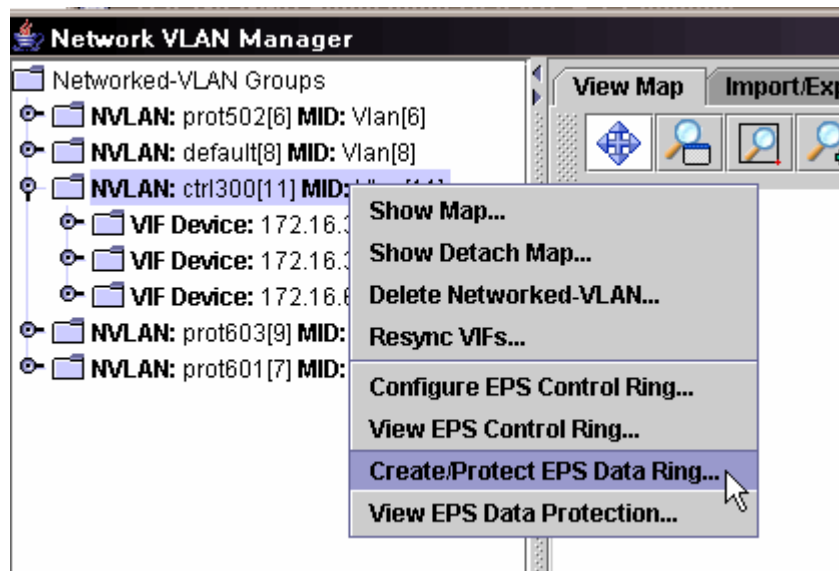

FIGURE 6-114 Creating an EPS Data Protection Ring by Copying a Control Network VLAN

In the Protection Ring Configuration Panel, the user selects **Configure Protection Scheme**. The Network VLAN Manager creates a “copy” of the control network VLAN (meaning creates a network VLAN that follows the same path as the selected Control VLAN), and brings up the create data ring dialog to assign a data VID. Refer to the following figure.

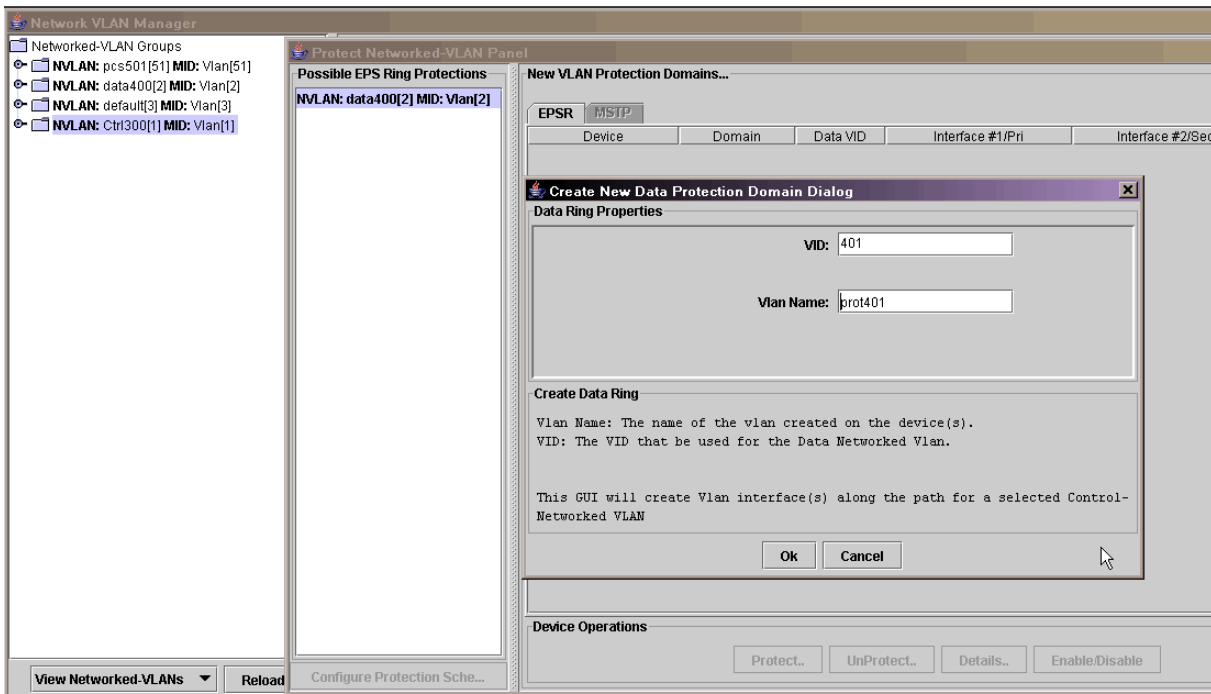

FIGURE 6-115 Creating an EP SR Data Ring by Cloning Control Ring

The user fills in the VID and the Vlan Name. The user clicks on OK, and this brings up the Protection Ring Configuration Panel with all columns filled in, as shown in Figure 6-116.

If more than one control ring could be applied to the data network VLAN, these will appear in the Possible EPS Ring Protections list. The user should select the one that will be used.

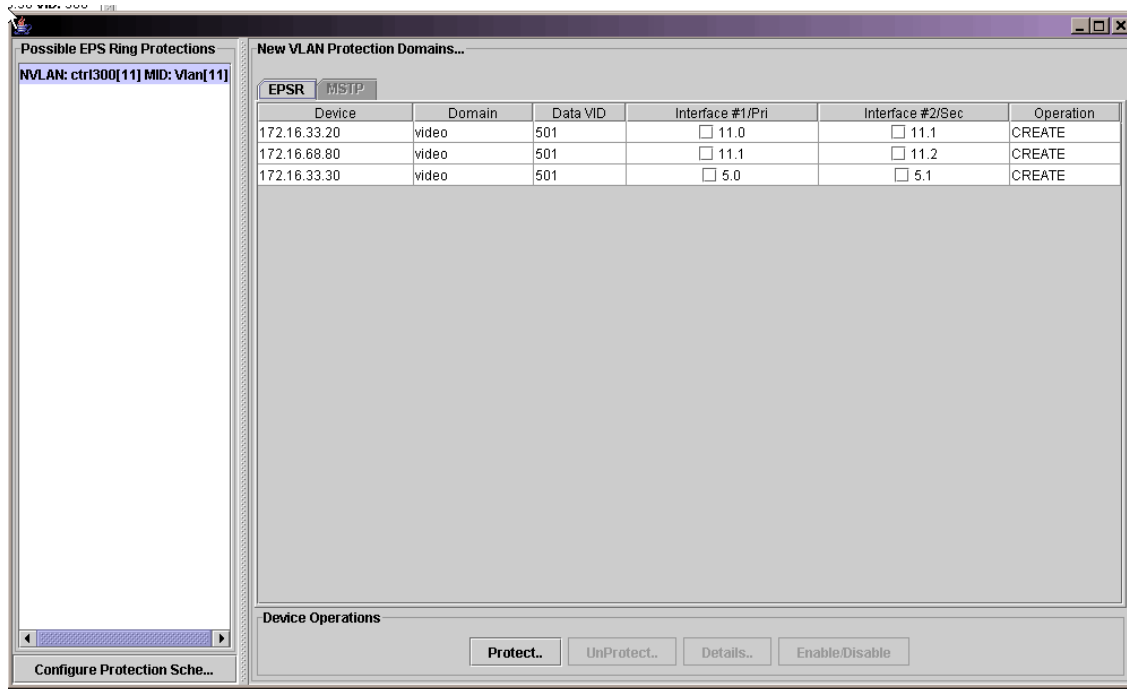

FIGURE 6-116 Protection Data Ring Configuration Panel

Finally, the user selects **Configure Protection Scheme**. The Task List window appears as the data ring attributes are applied to the devices. The data ring is now included in the protection domain of the associated control ring.

Table 6-27 lists the fields of the Configure EPS Data Ring panel.

TABLE 6-27 Fields for the Configure EPS Data Ring Panel

Option	Purpose
Configure Protection Scheme	Applies (CREATE operation) the EPS data ring attributes (control ring domain, VID, etc.) to the devices listed.
New VLAN Protection Domains... panel	Lists the relevant information for the created data protection ring (No fields are editable) Device: The name that has been given to the device Domain: The domain of the associated EPS control ring Data VID: The VID that will be used to define the VLAN interfaces for the devices Interface #1/Pri: The ports that make up the primary interface Interface #2/Sec: The ports that make up the secondary interface Operation: The next logical operation that can be performed.
Device Operations	Options to perform on the protected data VLAN Protect - Will create the protection ring over the domain of the control ring. Unprotect - Activated only when the EPS Data Ring has already been created, allows the user to delete the protection domain for the network VLAN. Note that the network VLAN itself is not deleted. Refer to 6.13.3.2.

- For **option 2**, an existing Data Networked VLAN is selected to become a Protected Data Network VLAN. The Network VLAN Manager shows the map for the VLAN Interface. The user then selects **Create/Protect EPS Data Ring**, and the Protection Data Ring Configuration Panel appears with the same options as shown in Figure 6-116. Once **Configure Protection Scheme** is selected, the application will complete the data protection ring (and create any additional VLAN Interfaces) as well.
- **Option 3** is similar to Option 2, but since the network data VLAN has already been configured as a ring, completion of the data network VLAN to form a ring by the application is not needed.

6.13.3.2 Unprotect Data Protection Ring

To unprotect an EPS data ring, the user selects the newly created data protection ring and right-clicks **View EPS Data Protection...** This brings up the Configure EPS Data Ring Panel with all of its attributes. The data ring can now be unprotected, using the following strategies:

- The user can choose a port to be deleted from the VLAN interface so that it will not form a loop after it becomes unprotected. Note that the unselected ports are the ones which will be unprotected.
- If the user chooses no ports, this will delete all the VLAN interfaces on **all** the devices.

6.13.4 Configuration Guidelines

The creation of an EPSR configuration should be planned and engineered carefully to ensure that the resulting topology has the desired results. The following notes and warnings that must be taken into account when the EPSR is introduced.

Note: One of the advantages of using the AlliedView NMS GUI (Network VLAN Manager application) is that many of these rules are automatically enforced or allow configuration errors to be easily seen and corrected.

Before configuring an EPSR topology, the following rules must be considered, since they will affect how the EPSR topology will fit into the network and how the network will be affected during the configuration steps:

- The ports used for EPSR are gigabit ethernet ports only.
- EPSR and other protection schemes (STP/RSTP) are mutually exclusive; **ports that use EPSR will have STP disabled.**
- Ensure that a loop is not created while provisioning the protected VLANs (or ensure that there is no traffic on the protected VLANs until the VLAN is added to the EPSR domain).
- Provisioning can be done in two ways:
 - Pre-provision - The AlliedView NMS allows the administrator to pre-provision the cards, links, and network VLANs. This does not affect current traffic since the hardware does not actually exist. Once the configuration is tested (GUI maps are checked), the hardware can be installed, links actually connected between devices, and the states of the devices will change so they are ready to pass traffic as pre-provisioned.
 - Post-provision - All the hardware is already provisioned, allowing the administrator to provision the EPSR control ring, add existing traffic-live network VLANs, and protect them.

Keeping in mind the rules above, the administrator should plan out the following:

- The devices, ports, and links between the ports that will be included in the EPSR configuration.
- The name and number of the control VLAN.
- The name of the domain that will include the master and transit devices, and for the master device which interfaces (ports) will be initially primary and secondary.
- The name and number of the protected VLAN(s) to be added to the EPSR domain.

6.13.5 Example Scenario

Figure 6-117 shows the physical/logical configuration for the example scenario.

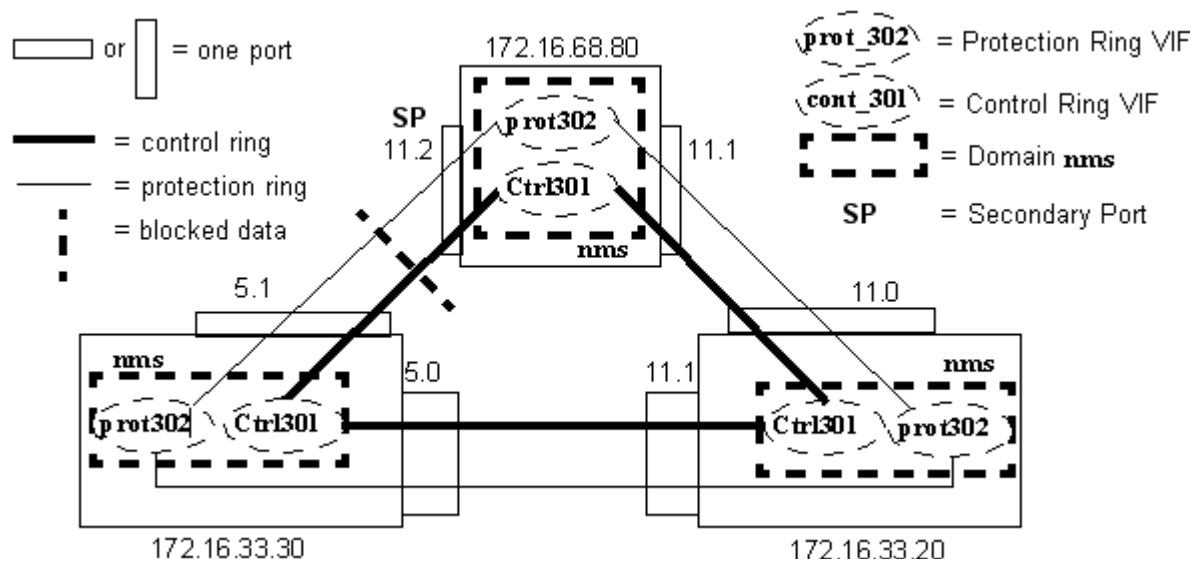

FIGURE 6-117 Example Ring Topology - Physical/Logical

6.13.5.1 Set up the Links Between the Ports

Using the NMS physical link feature, create a spreadsheet that includes the links (with devices and ports) that will be included in the EPSR configuration. Load the spreadsheet so that the physical links in Figure 6-118 are known to the AlliedView NMS. The following figure shows an example spreadsheet. Refer to 6.7.5 for creating and importing a spreadsheet.

	A	B	C	D	E
## Auto Generated Telesyn NMS R2.0 Link Planning Information					
LinkName		Source Device	Source Port	Destination Device	Destination Port
link1		172.16.68.80	11.1	172.16.33.20	11.0
link2		172.16.68.80	11.2	172.16.33.30	5.1
link3		172.16.33.20	11.1	172.16.33.30	5.0

FIGURE 6-118 Example Spreadsheet

6.13.5.2 Create a Closed Network VLAN that will become the Control Ring

Using the Network VLAN Manager, create a new networked-VLAN, as shown in Figure 6-119

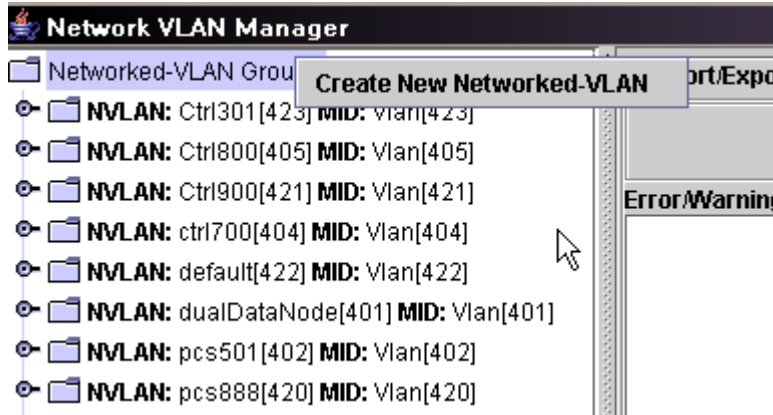

FIGURE 6-119 Creating a Network-VLAN to Become a Control Ring

In the resulting Initial Vlan Information window, fill in the Control VLAN values, as shown in Figure 6-120.

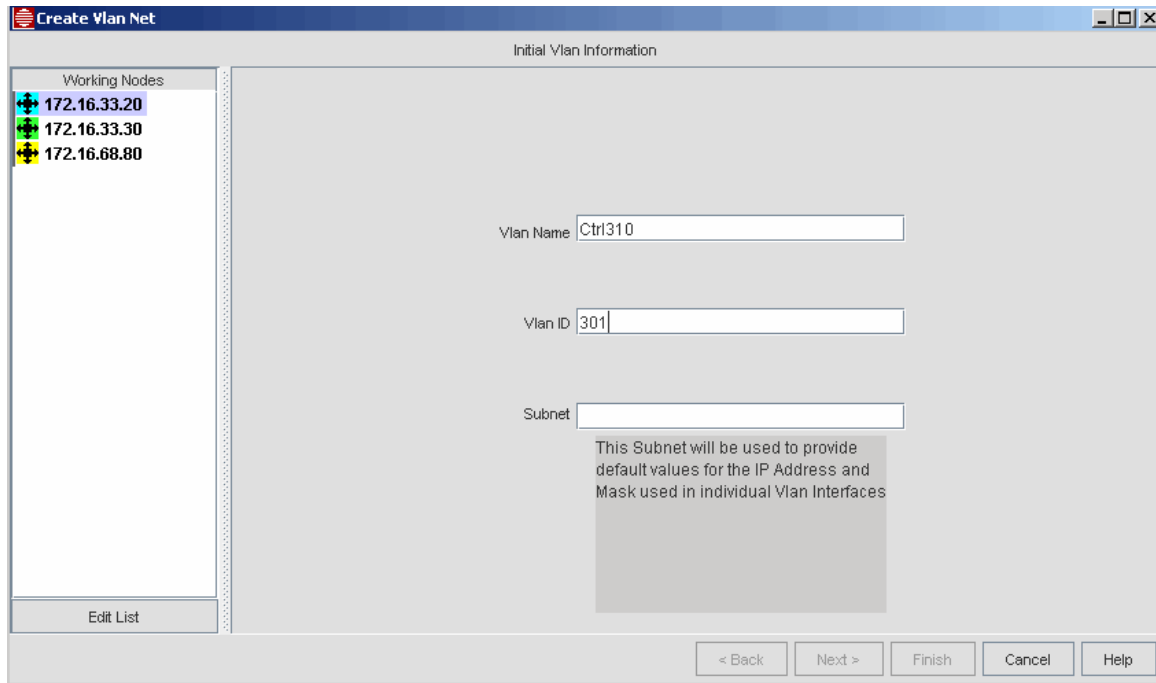

FIGURE 6-120 Data filling Control VLAN Values

A looped network VLAN for the devices has now been created, and so can be configured as the control ring.

6.13.5.3 Configure the Control Ring

With the network VLAN (Ctrl301) created, use the Network VLAN Manager to configure the Control Ring, as shown in [Figure 6-121](#). [Figure 6-122](#) warns the user about disconnecting unprotected Network VLANs and that STP will be disabled.

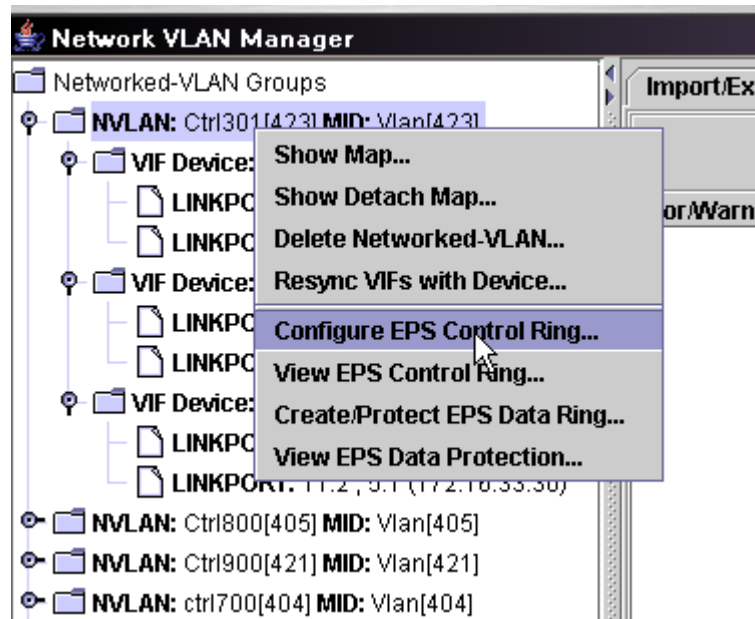

FIGURE 6-121 Configuring Network VLAN as Control Ring

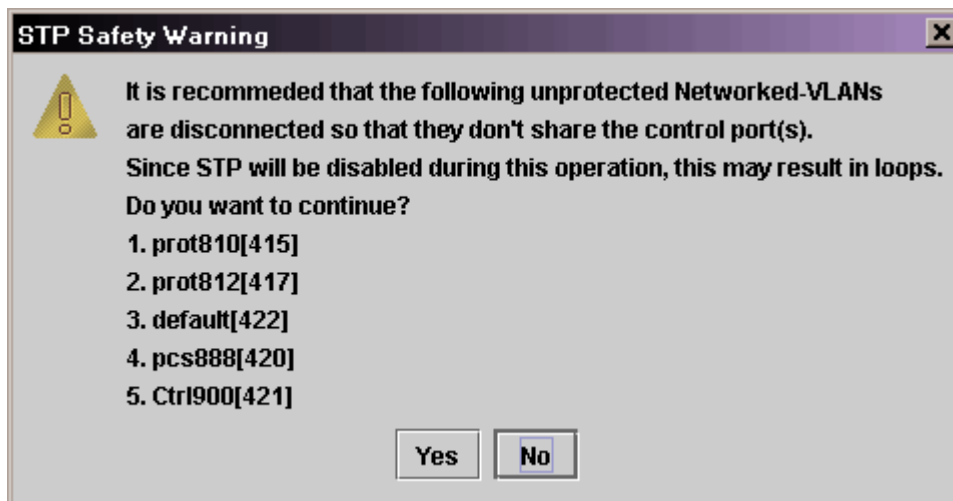

FIGURE 6-122 STP Safety Warning

Clicking on **Yes** brings up the **Create New VLAN Protection Domain** Dialog. Fill in the domain (dom300) and adjust the protocol values if necessary, as shown in [Figure 6-123](#).

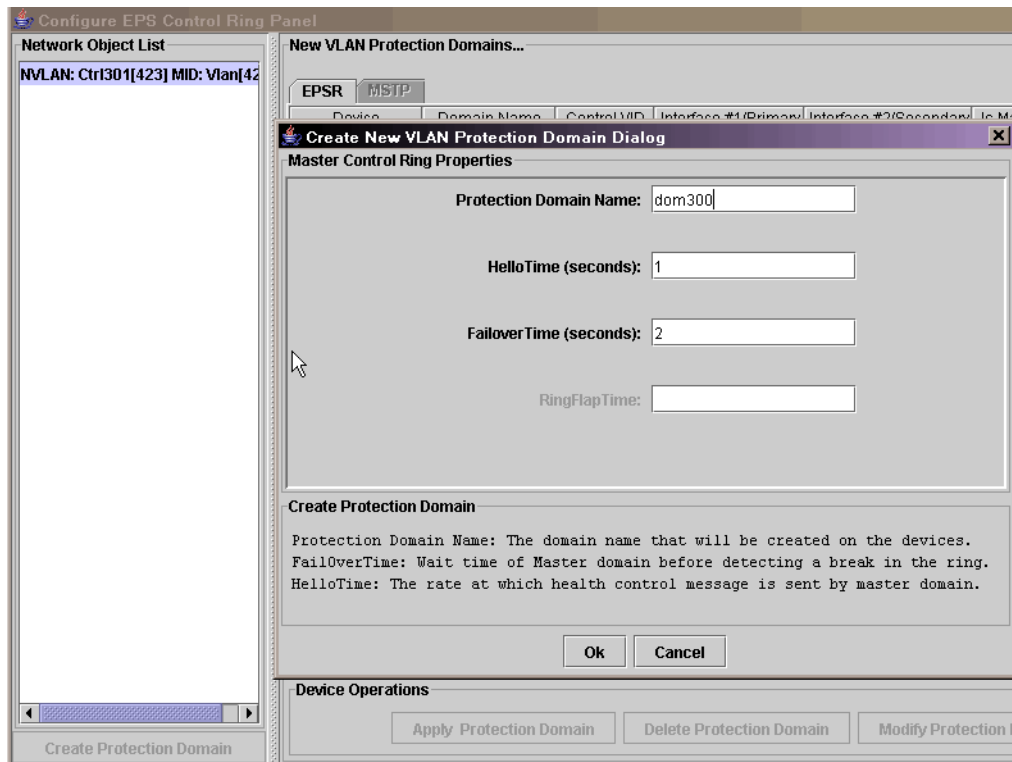

FIGURE 6-123 Creating Control VLAN Domain

Clicking on **OK**, the configuration that will be created is shown in [Figure 6-124](#).

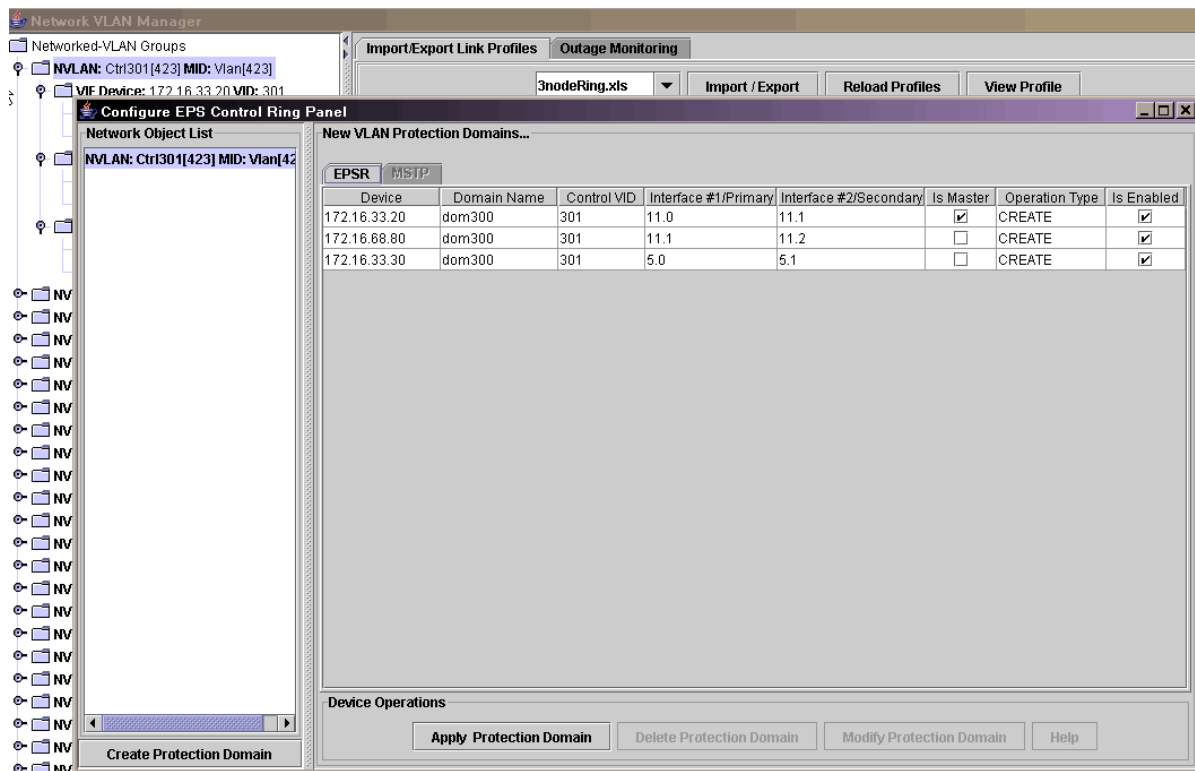

FIGURE 6-124 Configuration for Control Ring Panel

Clicking on **Create Protection Domain** invokes the Task Manager, which lists the task being performed for each device. Once the tasks complete successfully, click on the Ctrl301 VLAN IF and the map shows graphically how the control VLAN is configured, as shown in Figure 6-125.

Refer back to Figure 6-117 to see how the GUI matches the planned configuration.

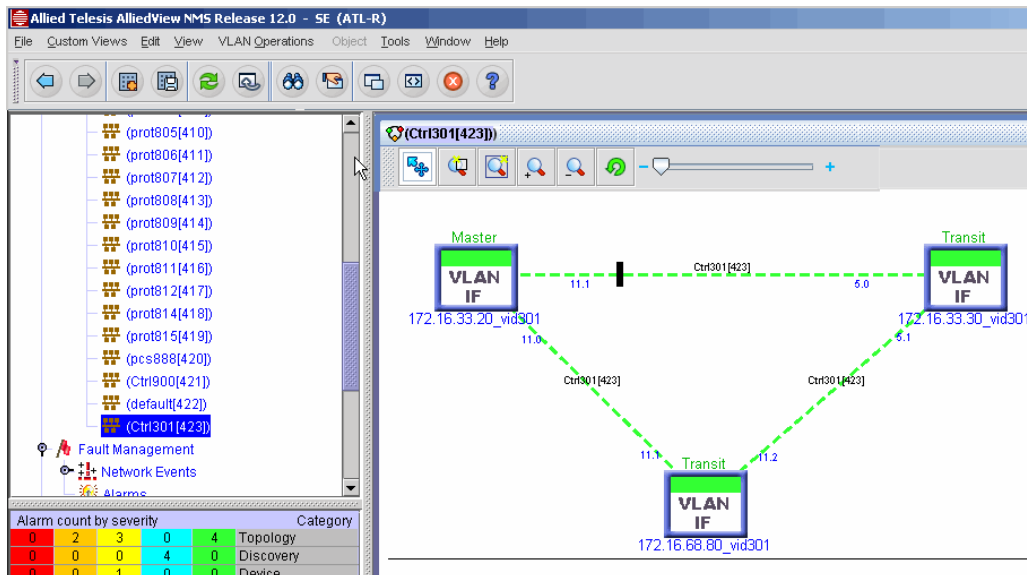

FIGURE 6-125 GUI of Control Ring

6.13.5.4 Create a Data Ring

A preferred way to create a Data Ring is to clone the just created Control Ring. In the Network VLAN Manager, select the Control Ring Network VLAN (Ctrl301) and right click on Create/Protect EPS Data Ring, as shown in [Figure 6-126](#).

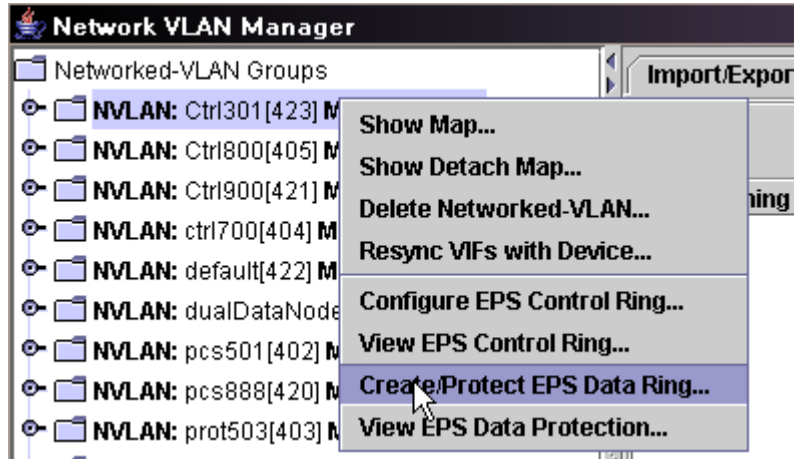

FIGURE 6-126 Creating a Data Ring from an Existing Control Ring

The Create New Data Protection Ring Dialog appears, as shown in [Figure 6-127](#).

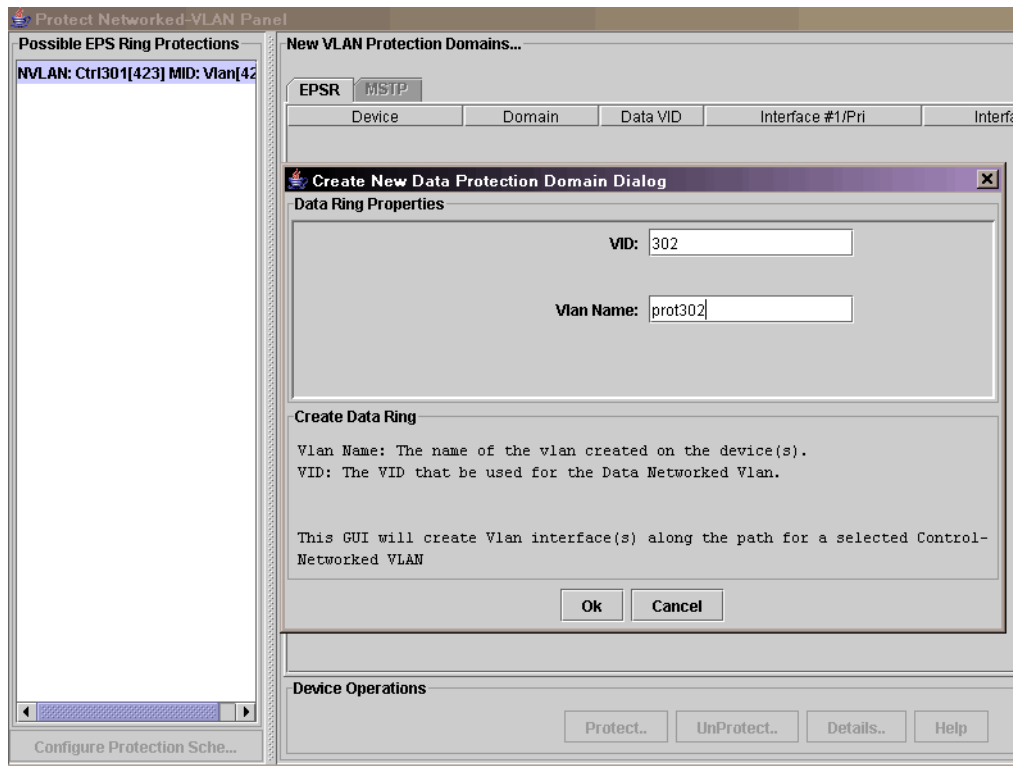

FIGURE 6-127 Creating the Protection Ring Network VLAN (from the Control Ring)

Input the VID (always a number) and Vlan Name and click on **OK**. The configuration that results from this is shown in [Figure 6-128](#).

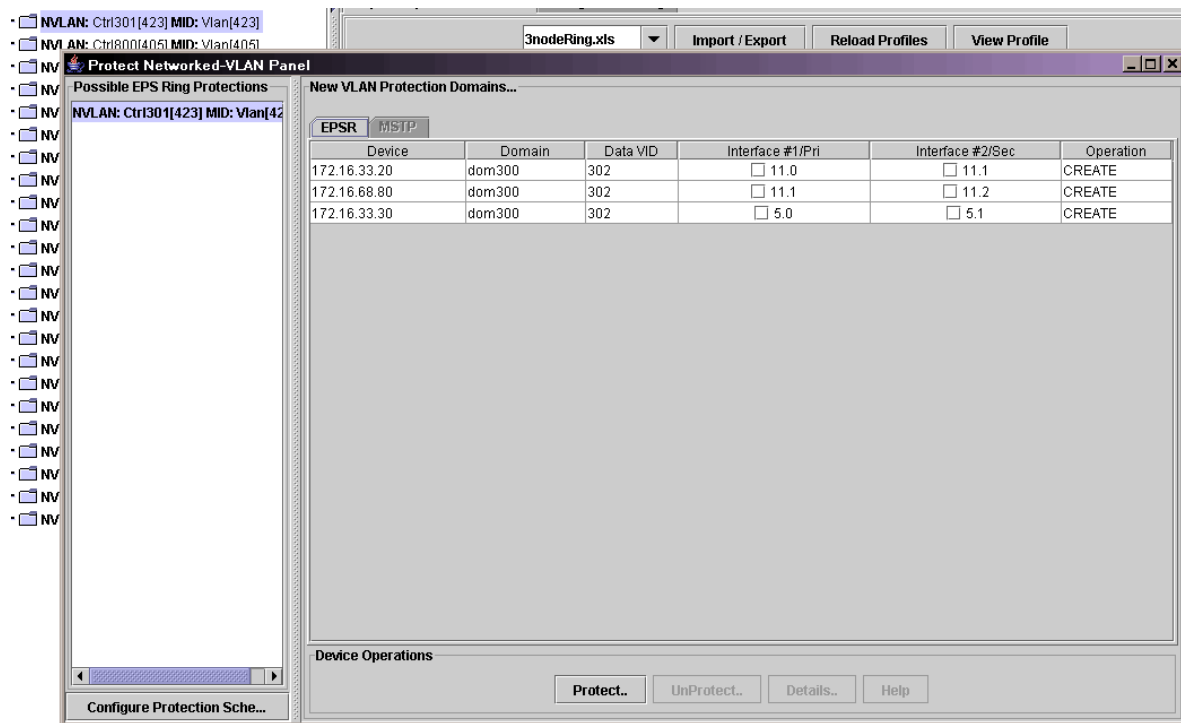

FIGURE 6-128 Configuration for Data Protection Ring

Clicking on **Configure Protection Scheme** brings up the Task window to perform the configuration for each device. Once done, selecting the VLAN IF for prot302 shows the GUI, in [Figure 6-129](#). Compare this to [Figure 6-117](#).

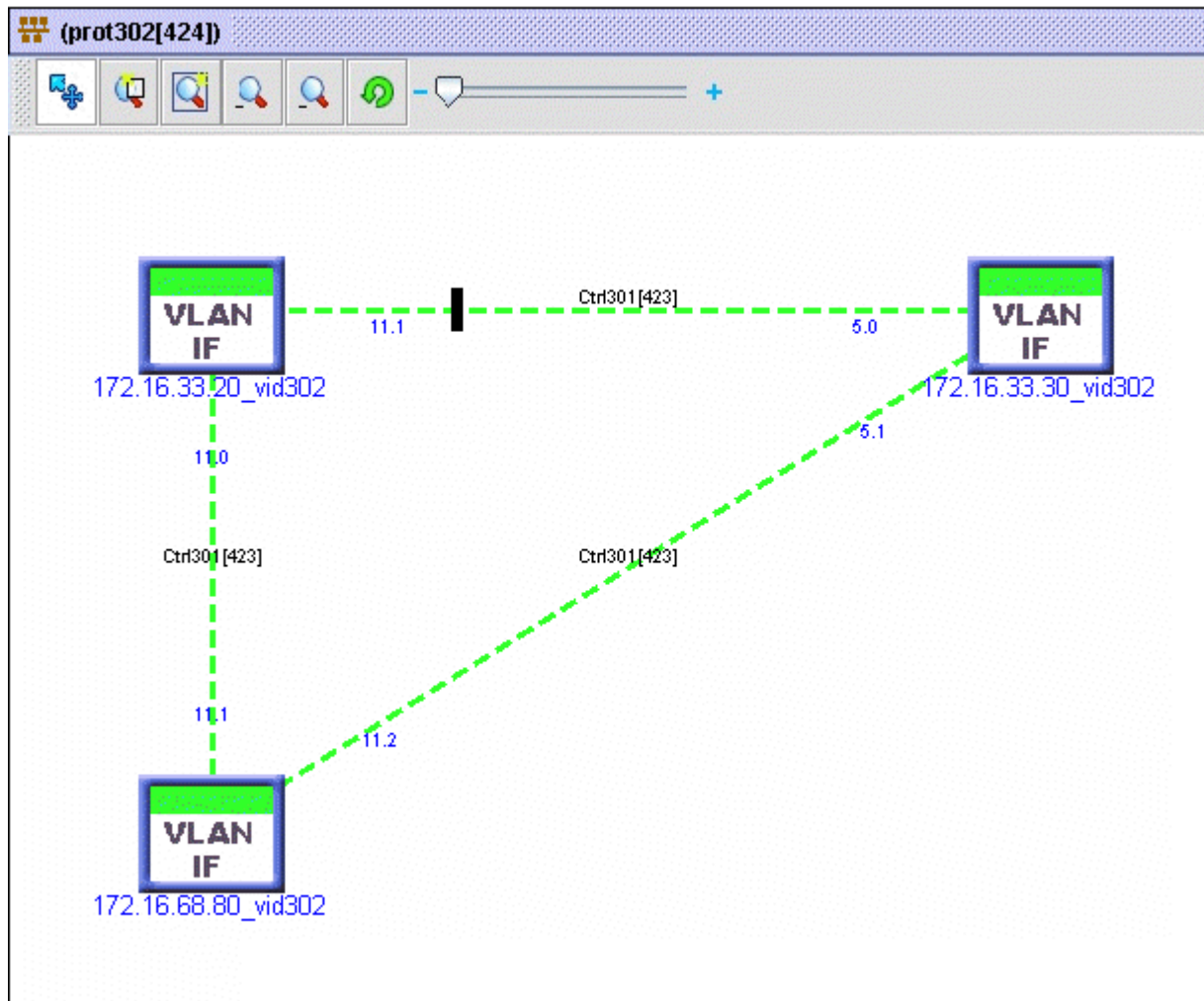

FIGURE 6-129 GUI for Configured Protection Data Ring

6.13.5.5 Reconfigure the Control and Data Rings

Now that the Control Ring and Data Ring are configured, another device may need to be added to the configuration. Performing this involves combining many of the network services tasks, summarized as follows:

- Reconfigure the links between two current devices and the new device.
 - Delete the link between the current devices.
 - Add the links between the new device and the two current devices.
 - Extend the VLANs to include the new device
- Associate the Control Ring with the extended VLAN Interface
 - Select the VIF to configure the Control Ring
 - Use the same domain name, and extend to the new device.
- Extend the Data Ring
 - Delete the Network VLAN of the Data Ring
 - Reclone the Data Ring from the Control Ring

6.13.5.6 Modify/Unprotect the Data Ring

The configured Data Ring can be modified if necessary. Select the Data Protection Ring and select View EPS Data Protection, as shown in [Figure 6-129](#).

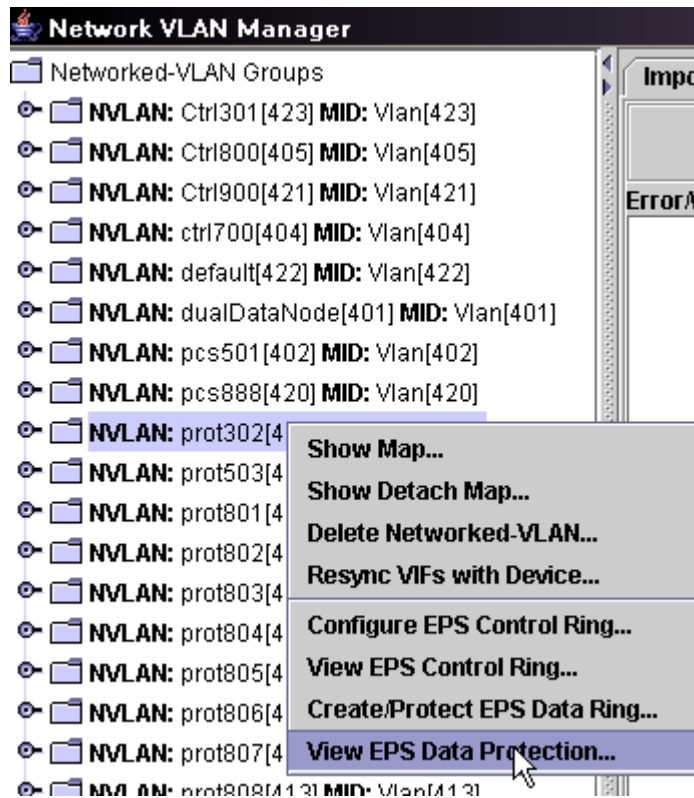

FIGURE 6-130 View Data Protection Ring

The VLAN Protection Scheme panel appears, showing the Domain, Data VIDs, etc, for the Data Protection Network VLAN, as shown in [Figure 6-131](#).

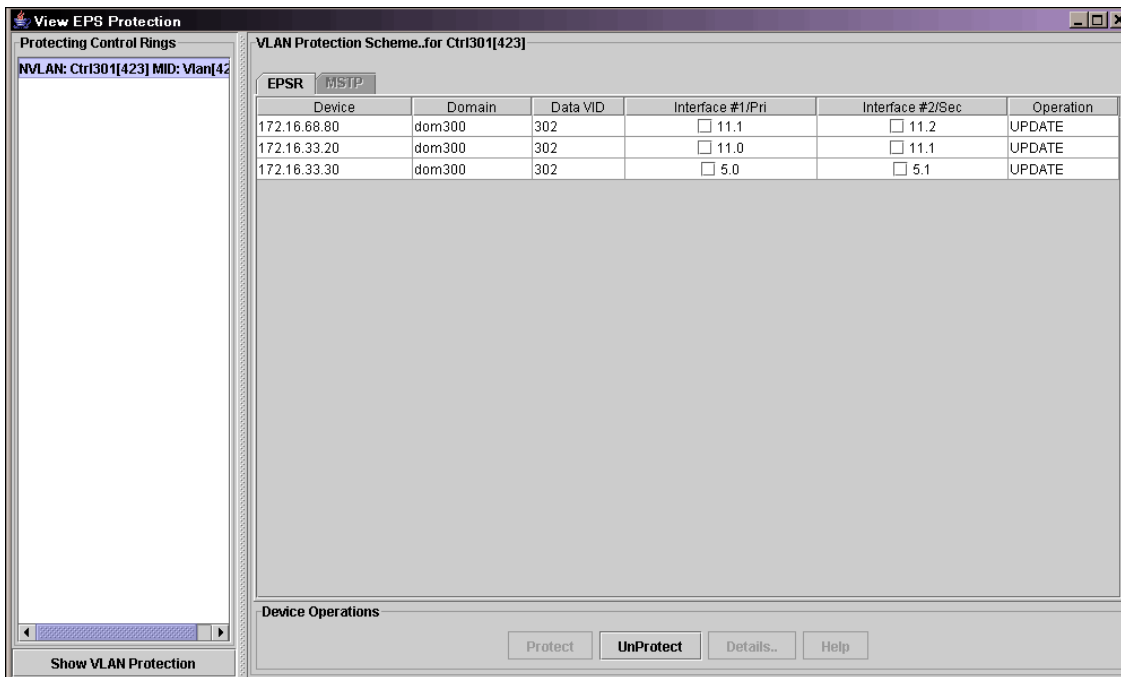

FIGURE 6-131 View Protection Ring Configuration

At this point the user could select one of the Primary Interfaces and click on Unprotect, as shown in Figure 6-132.

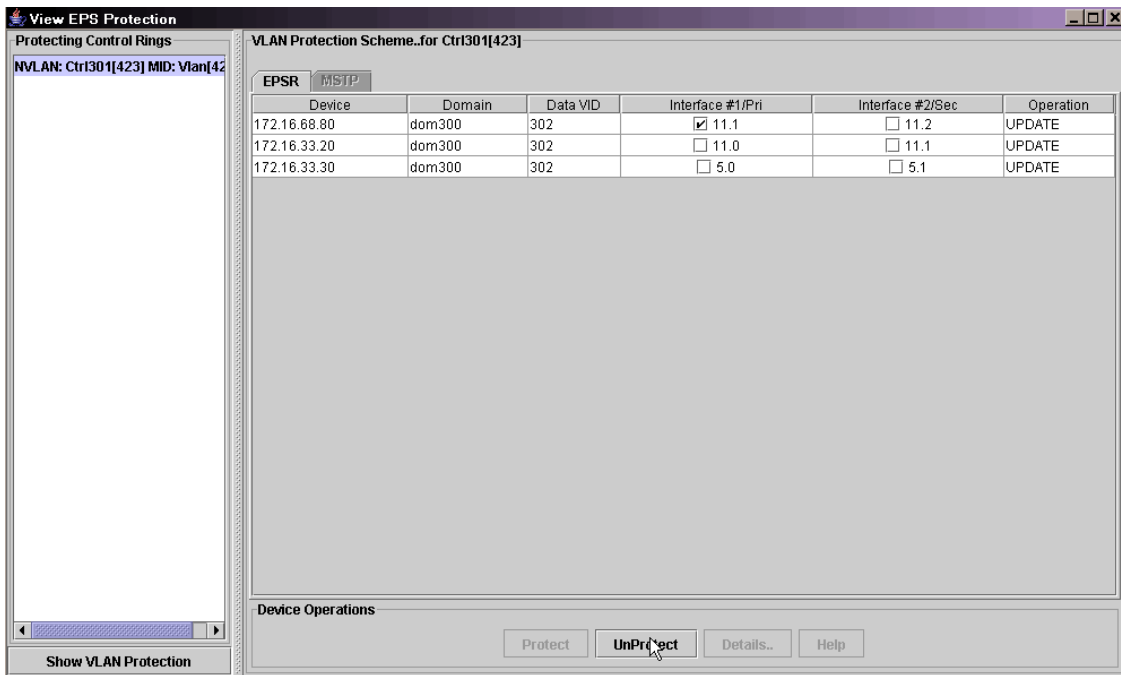

FIGURE 6-132 Selecting an Interface on a Device and Unprotect

After the Task Details Window had opened and closed, the user could select the VLAN IF and see that the Network VLAN no longer had a protection scheme, as shown in Figure 6-133. Since 11.1 of 68.80 is selected, the link will be retained (port will not be deleted).

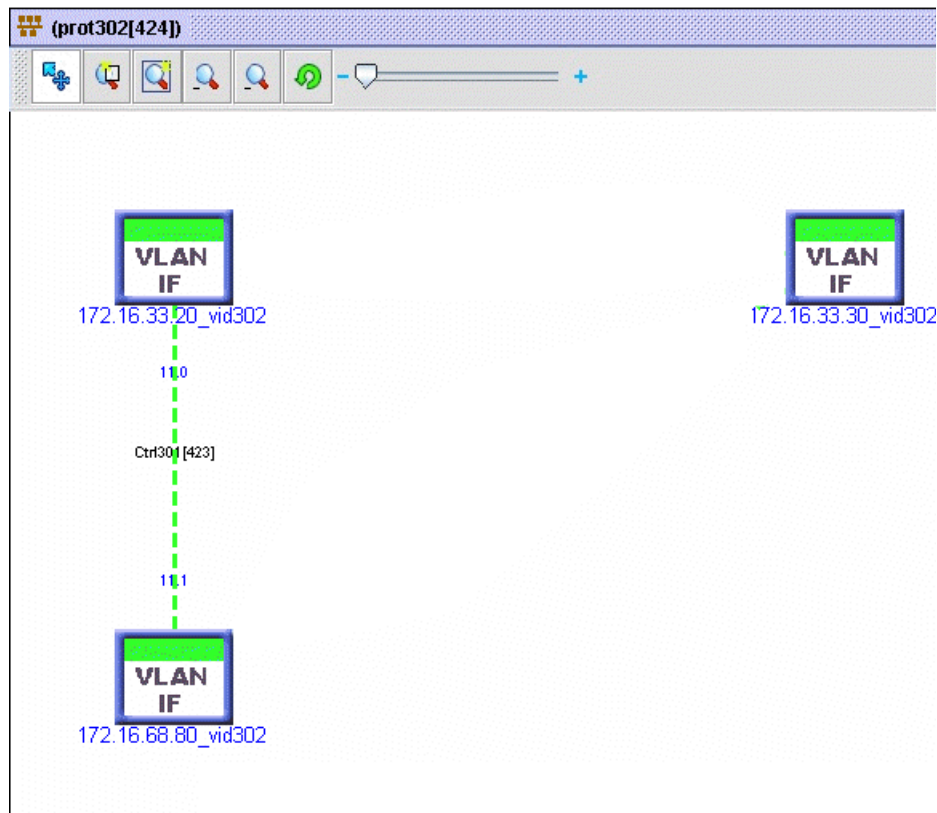

FIGURE 6-133 GUI for Network VLAN no Longer with a Protection Scheme

6.13.6 Troubleshooting the EPSR Configuration

Using the AlliedView NMS GUI allows the network administrator to more easily understand and resolve the following maintenance scenarios:

- The EPS Control and Data rings are not configured properly and so cannot provide the protection service as described in [6.13.1](#)
- A path for the protected data VLAN has broken, and the secondary path has been activated.
- Both the primary and secondary paths for a device are broken, with a loss data service to and from that device.

6.13.6.1 Errors in EPSR Configuration

By using the AlliedView NMS GUI, the administrator can usually avoid most configuration errors and produce a control ring and associated data rings that follow the configuration guidelines listed in [6.13.4](#). However, if there are configuration errors (usually done by configuring each device separately through the command interface), the GUI allows the user to easily spot the configuration fault and correct it.

Common EPSR configuration errors can be grouped as follows:

- The protection VLAN is actually unprotected on a device:
 - The protected VLAN interface is not part of the domain with the control VLAN interface
 - The EPSR domain is part of a different control ring.
- The control VLAN is not configured completely/properly
 - There are multiple Masters or no Masters.
 - The device is not part of the domain (there are no Master/Transit indicators on the VLAN Interfaces).

- There is an incomplete loop (usually a missing link or device).

In Figure 6-134, a control ring has been configured following the example in Figure 6-117. The .80 device is the master node and the .30 node is a transit node and both are configured (and connected) with the Ctrl300 as the network VLAN. The .20 device is also connected to the ring but is not protected by the Control VLAN Ctrl300. Note that these Ctrl300 labels are in red. Moreover, there are question marks in red on the links coming from the ports. Finally, note that the .20 device has no transit label above it.

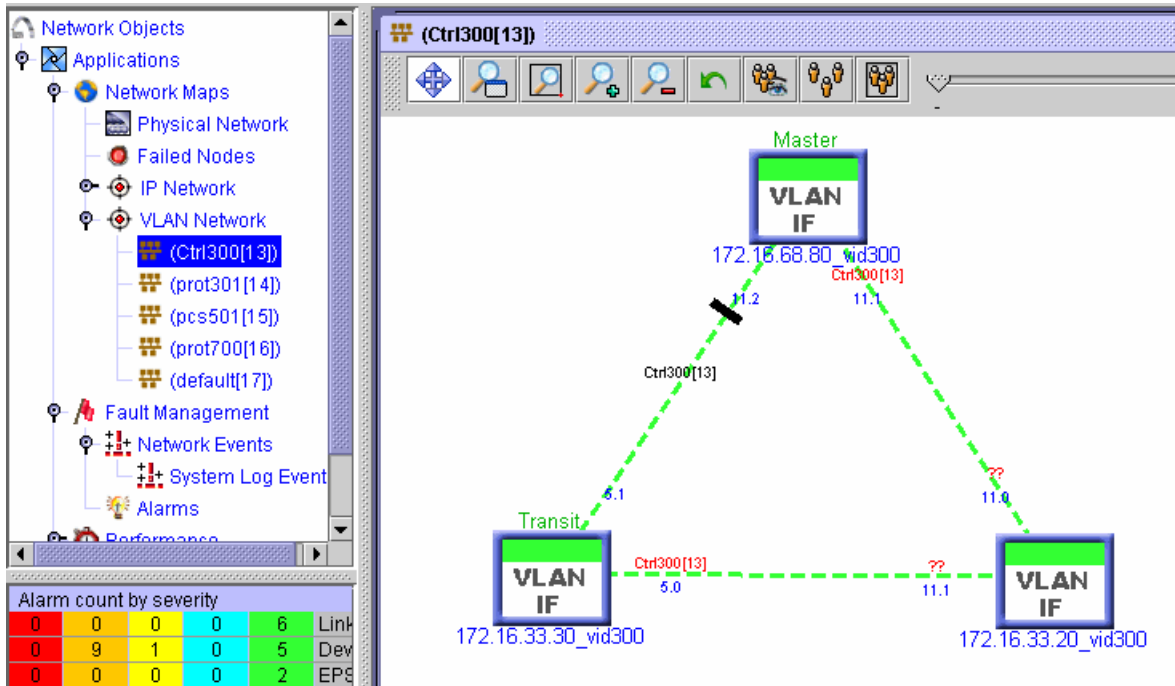

FIGURE 6-134 Misconfigured Control Ring

To query this configuration, the user can right click on the .20 device and select **View EPS Control Ring**. The following message appears, as shown below.

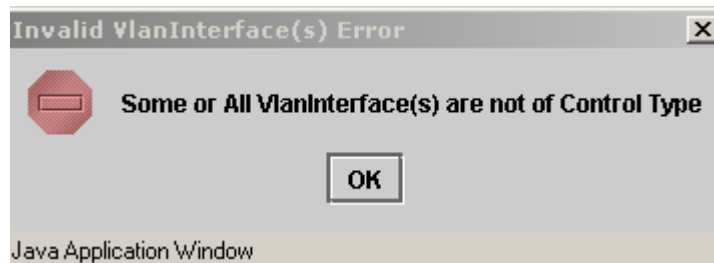
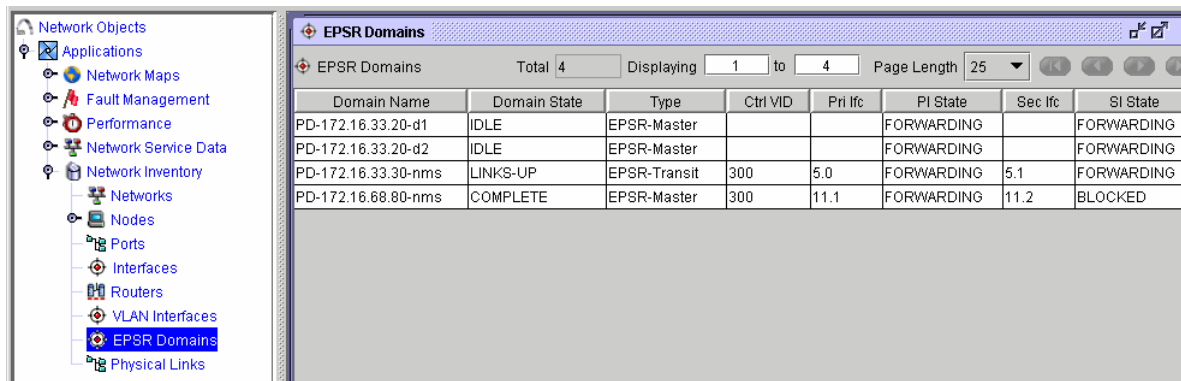

FIGURE 6-135 Error Message for Misconfigured Control Ring

To view the overall attributes of the EPSR configurations, go to Network Inventory and select EPSR Domains, as shown in the following figure.



Domain Name	Domain State	Type	Ctrl VID	Pri lfc	PI State	Sec lfc	SI State
PD-172.16.33.20-d1	IDLE	EP SR-Master			FORWARDING		FORWARDING
PD-172.16.33.20-d2	IDLE	EP SR-Master			FORWARDING		FORWARDING
PD-172.16.33.30-nms	LINKS-UP	EP SR-Transit	300	5.0	FORWARDING	5.1	FORWARDING
PD-172.16.68.80-nms	COMPLETE	EP SR-Master	300	11.1	FORWARDING	11.2	BLOCKED

FIGURE 6-136 EP SR Domains table

Note that the domain name nms is not included for the .20 device for the Ctrl VID 300. Since the links and VLAN interface do exist (according to the GUI maps), the problem must be that the .20 device is not protected by any EP SR Control ring and is not part of a domain.

To resolve this problem, the user can bring up the VLAN Interfaces on .20 device (in this case the VID: 300) and select **Configure EP SR Control Ring ...** as shown below. This allows the user to associate the VLAN Interface with the domain used by the Control VLAN.

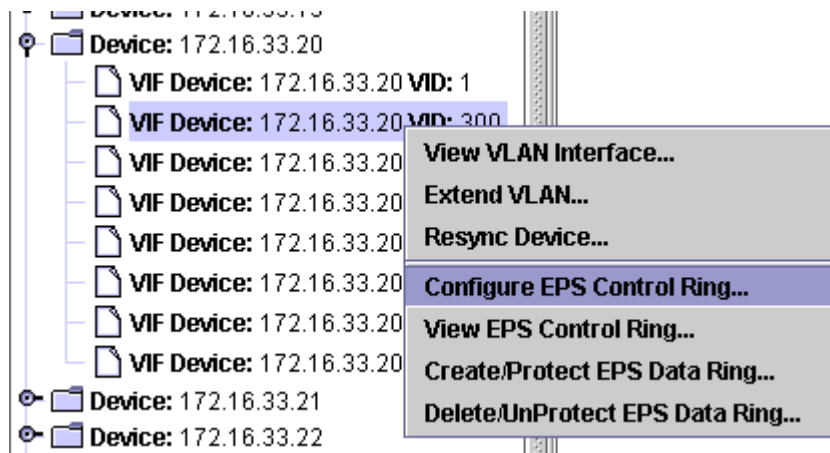

FIGURE 6-137 Control Ring Misconfiguration

6.13.6.2 EP SR Activated (SP Port Now Used for Data Flow)

When any link in the ring is broken, except the link connected to the master's secondary port, the secondary port link is unblocked so data can travel on the alternate path. Details of what is happening to the control messaging are explained in the iMAP User Guide. At the AlliedView NMS, there are several windows that show pictorially what is happening.

Note: The following figures assume that port 11.1 on the .20 device has been disconnected or disabled.

- Control Ring - The following figure shows that the link between the .20 and .30 device is now blocked. The link between .30 and .80, which was previously blocked, has now been opened so that traffic that used to go from .30 to .20 and then to .80 is now going directly to the .20. Moreover, the Master and Transit labels are now red.

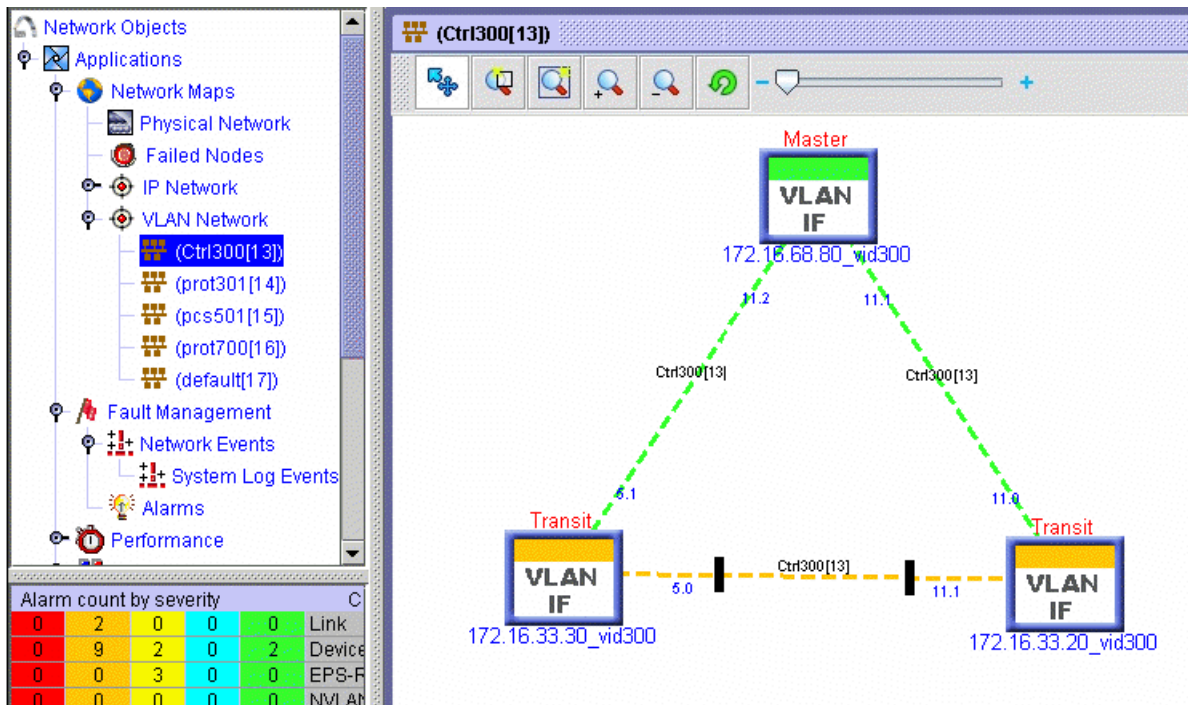

FIGURE 6-138 GUI when EPSR Activated

- Network Inventory - The table now includes the LINK DOWN and FAILED states for domain nms and the changed FORWARDING and BLOCKING states that reflect the VLAN map GUI.

Domain Name	Domain State	Type	Ctrl VID	Pri Ifc	PI State	Sec Ifc	SI State	Status
PD-172.16.33.20-d1	IDLE	EPSR-Master			FORWARDING		FORWARDING	DISABLED
PD-172.16.33.20-d2	IDLE	EPSR-Master			FORWARDING		FORWARDING	DISABLED
PD-172.16.33.20-nms	LINK-DOWN	EPSR-Transit	300	11.0	FORWARDING	11.1	BLOCKED	ENABLED
PD-172.16.33.30-nms	LINK-DOWN	EPSR-Transit	300	5.0	BLOCKED	5.1	FORWARDING	ENABLED
PD-172.16.68.80-nms	FAILED	EPSR-Master	300	11.1	FORWARDING	11.2	FORWARDING	ENABLED

FIGURE 6-139 EPSR with FAILED States

- Alarms - Viewing the alarms shows all of the associated alarms, as highlighted below.

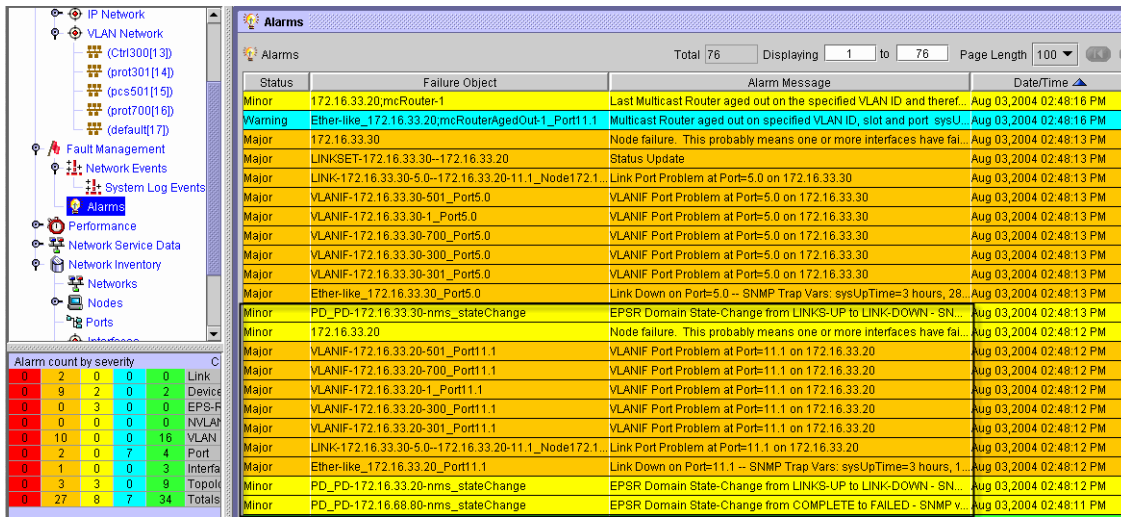

FIGURE 6-140 Alarms of EPSR with FAILED state

6.13.6.3 EPSR Failed (No Ports for Data Flow on Device(s))

When both paths are broken there is no data path to or from a device, so data service is lost on that port. In this case, the map GUI and alarms reflect this loss of service situation.

- Protection Ring - Both links for device .20 are shown as blocked, so data traffic for this Protection VLAN cannot be received or transmitted on the device.

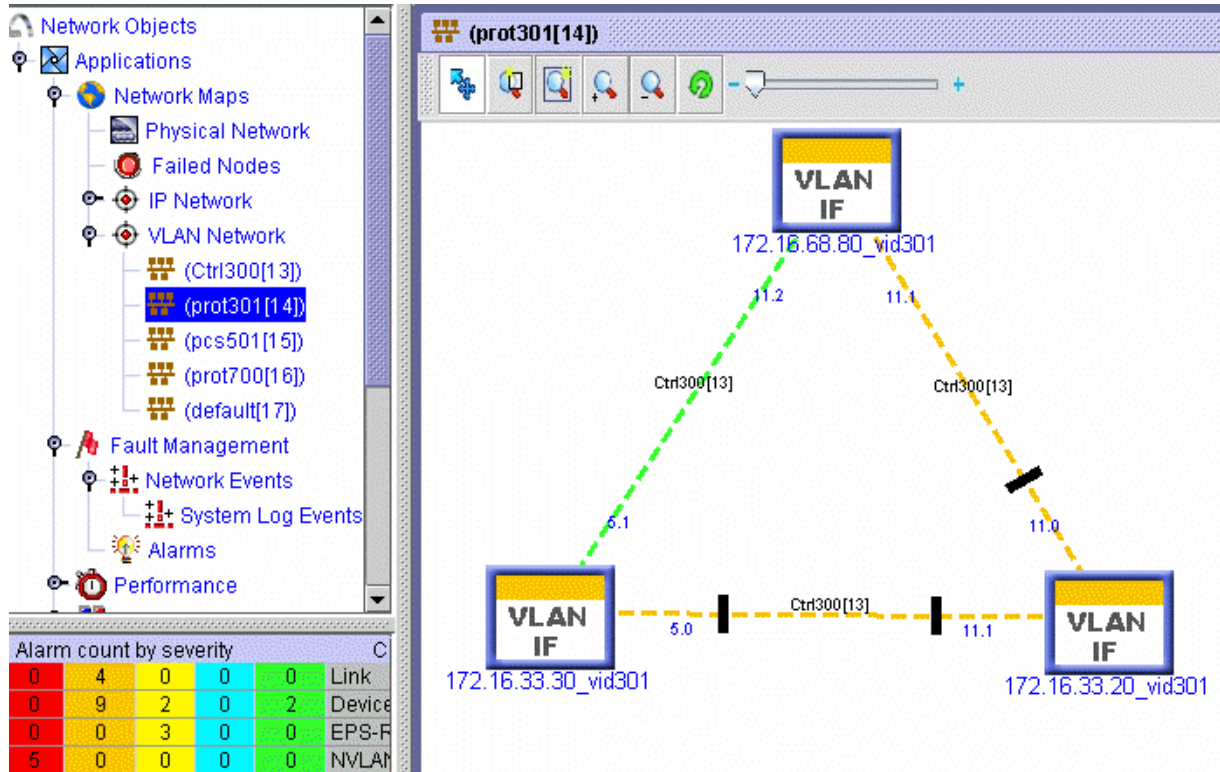

FIGURE 6-141 Protection VLAN prot300 when Both Ports Down

- Alarms - Viewing the alarms shows all of the associated alarms, as highlighted below.

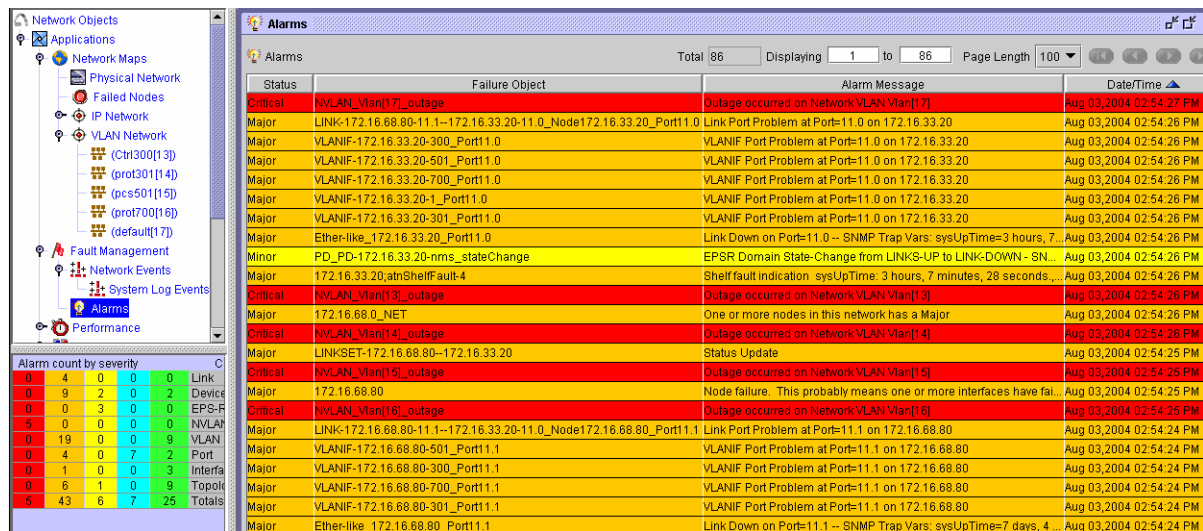

FIGURE 6-142 Alarm View for EPSS Failure

6.13.7 Status of Transit Nodes for AlliedWare Plus Devices

When AlliedWare Plus devices, which include the SB x908, x900-12X and -24X series, are included in the EPSS ring as Transit Nodes, their state may or may not reflect any changes that may have occurred. This occurs because the devices fail to send a trap when the EPSS state changes. As a result, only a rediscovery of the nodes can guarantee that the state reflected in the GUIs (such as when selecting *Network Inventory* -> *EPSS Domains*) is correct.

6.14 SuperLoop Prevention (Superring)

6.14.1 Overview

Prior to release 9.0., if **all** the following conditions were present, a loop could occur between nodes when the EPSR feature was working correctly:

- The network had two or more EPSR domains.
- The protected (data) VLAN overlapped two or more EPSR domains.
- The EPSR domains and the overlapping protected VLANs shared a common link.

When there was a common link failure, each ring would block the appropriate interface, but this could lead to a larger loop, or SuperLoop, being created. Because of this, EPSR rings that had all the attributes listed above were not allowed.

To resolve the SuperLoop issue, the concept of certain ring interfaces having a **priority** is introduced. This priority is assigned to the control VLAN on the interface. The value range is 0 to 127. By default, the priority of each of the ring interfaces for an EPSR domain is 0 (the lowest priority), and means there is no change in how the interface and protocol works prior to release 9.0. The higher values, however, are used when there are interconnected EPSR rings in which the SuperLoop condition needs to be avoided.

When creating this configuration, which is called a **SuperRing**, the user will therefore specify an EPSR Priority when an EPS Ring is created. When the user enters a value greater than 0, this indicates the ring is intended to be used with other peer rings to form a SuperRing. If the user sets the priority to 0, then the ring will behave as an ordinary EPS Ring as described in [6.13](#).

As with creating regular EPS Rings, the user should first decide on the VLANs and topologies to be used based on iMAP recommendations.

The following figure shows how the feature would work with two EPSR rings and an interconnected data VLAN over a common physical link. This configuration will be the result of using the AlliedView NMS SuperLoop feature that makes up the rest of this Section.

Note that there are several configuration rules that must be followed since there can be multiple ring domains that share one or more protected VLANs. These rules are described in detail in the iMAP User Guide. By using the AlliedView NMS to create an EPSR SuperLoop configuration and following a recommended series of steps, the user can ensure that these rules are automatically followed. Moreover, there are appropriate warning messages when the user should be made aware of changes that are being made to a configuration.

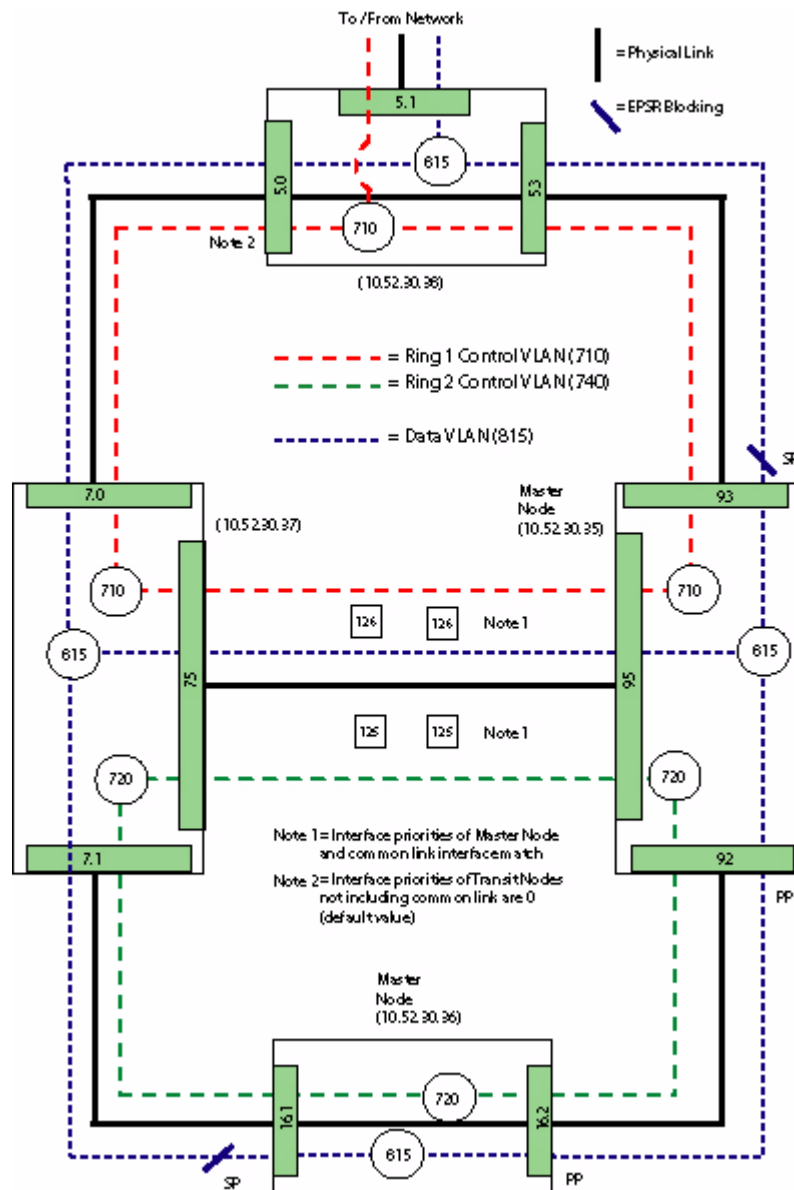

FIGURE 6-143 Example Configuration for SuperLoop Feature

Following the example shown in the figure, the user wishes to have one ring at priority 126 and the other at 125. The major steps to create this configuration are as follows:

1. Create the first EPS Ring with a Control VLAN of 710, with a domain name of ctrl710. This is the same as creating an EPS Ring in Section 6.13, but the user specifies Priority=126.
2. Create a second EPS Ring with the Control VLAN for 720 and the domain name ctrl720. For this ring, specify Priority=125. Since the rings are to be peers, the iMAPs that contain the shared ports will not permit the domains to be enabled at this point. (not until they have at least one common data VLAN).
3. If the SuperRing is to have more rings on it, add them one-by-one as they connect to the existing rings.
4. To add a protected data VLAN to the SuperRing, select **any** one of the Peer control VLAN maps and create a protected VLAN. **This VLAN will automatically be extended to the entire SuperRing domain** (all of the EPSR domains that make up the SuperRing).
5. Any EPSR domains that are disabled can now be enabled.

At the end of the procedure, all created rings are part of the SuperRing, and any Protected VLANs created on the original ring will be protected by the SuperRing domain.

Additional Protected VLANs can be added after the Super-Ring is created by selecting any one of the control ring maps and creating a protected VLAN on it. The NMS will automatically extend that data VLAN to all of the peer domains. This permits creation of protected VLANs without disabling the Super-Ring, since the iMAP requires the protection to be configured on all peer domains of a device at the same time.

6.14.2 Creating the EPSR SuperRing

6.14.2.1 Create a Network VLAN and with it Create an EPSR Control VLAN

These steps are similar to those described in 6.3 and 6.13. The user selects one or more nodes on the Physical Network map and by using the Create VLAN Net Form creates a loop VLAN that includes the appropriate nodes and interfaces. The user then turns this Network VLAN into an EPSR Control VLAN (creating the EPSR domain) by right clicking on the GUI of the Network VLAN that is a ring and selecting “Configure EPS Control Ring”.

Note: The user can also choose the VLAN Operations menu pull-down.

Making this choice brings up the Configure EPS Control Ring Panel, as shown in the following figures.

Note: When a network VLAN has been configured as a ring, the icon for a ring  appears as the leaf in the VLAN Network tree hierarchy.

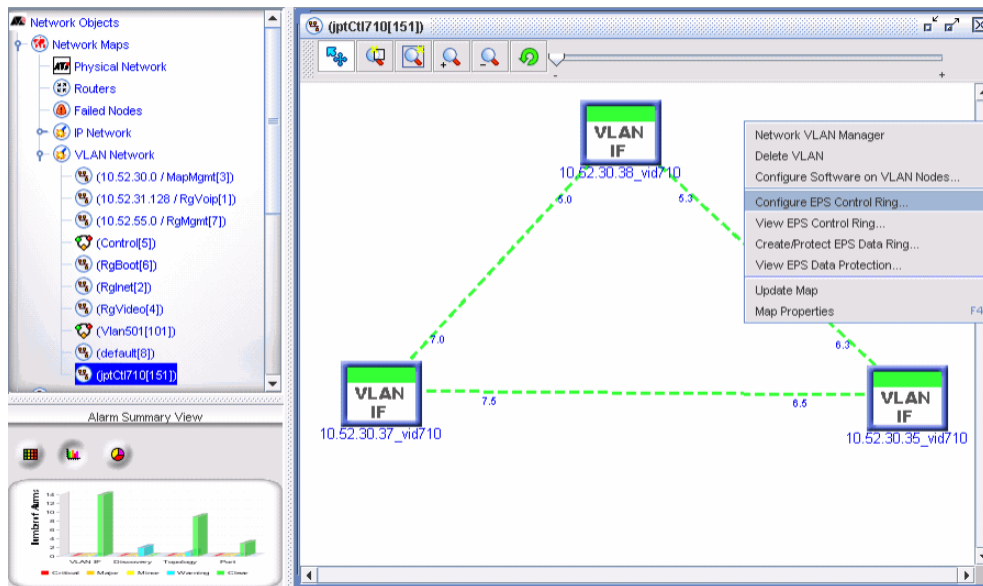

FIGURE 6-144 Configure EPS Control Ring Menu Item

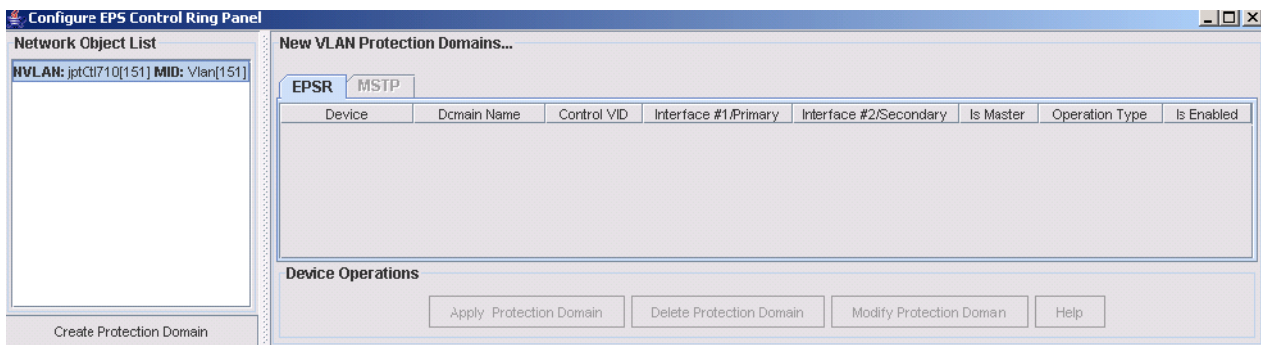

FIGURE 6-145 Configure EPS Control Ring Panel

The Network VLAN should be highlighted on the left panel. (If not select the loop Network VLAN), then select “Create Protection Domain”. This brings up the Create New VLAN Protection Domain Dialog Form, as shown in the following figure.

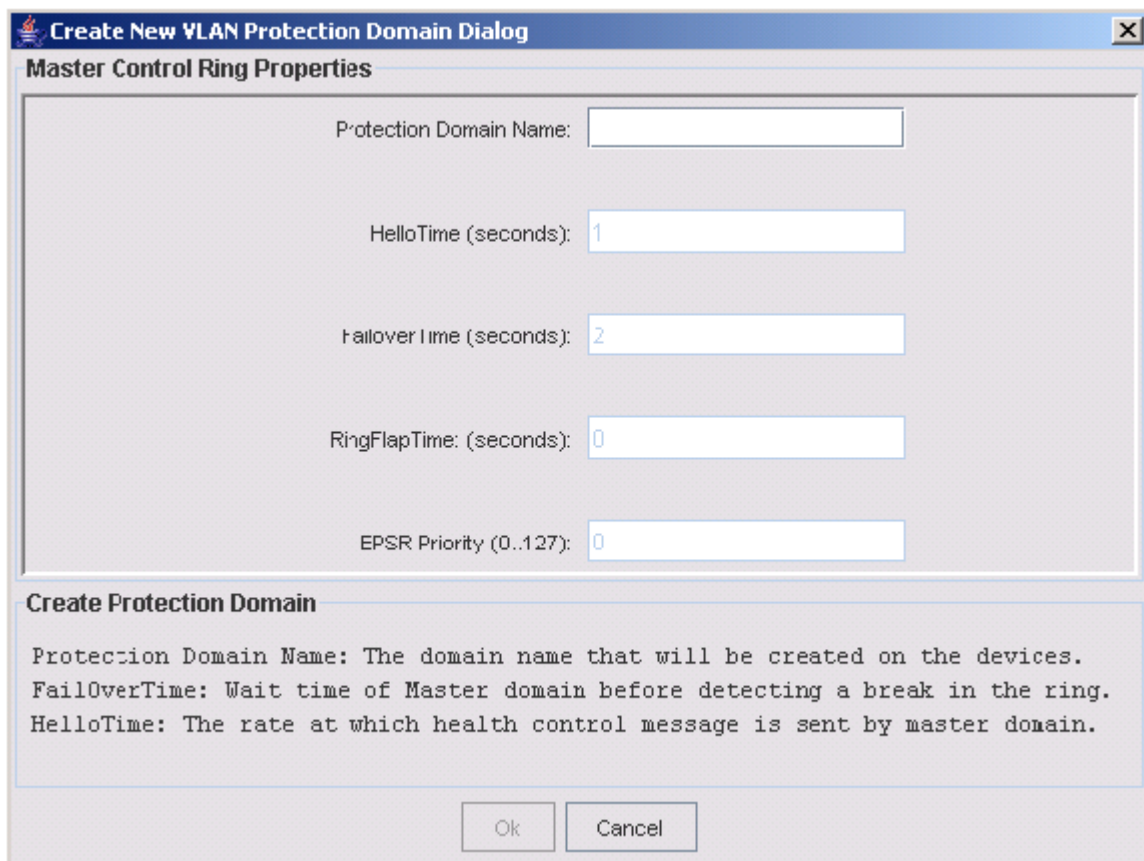

FIGURE 6-146 Create New VLAN Protection Domain Dialog (Initial)

Enter the **Protection Domain Name** = jptDom710 and the **EPSR Priority**=126. By putting in a non-zero value, the user intends to use the this EPS Ring in a SuperRing configuration. Finish by selecting OK, and the system will show how the devices will be configured. Refer to the following figures.

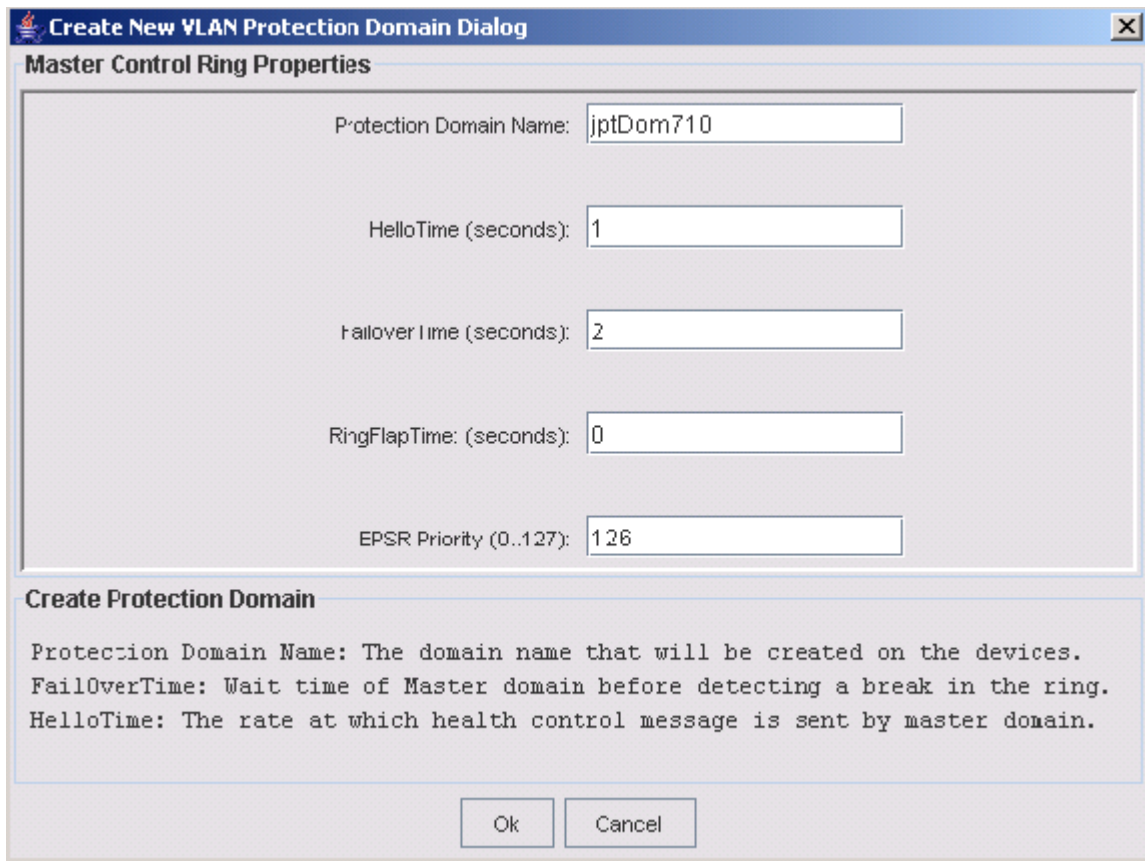

FIGURE 6-147 Create New VLAN Protection Domain Dialog (Complete)

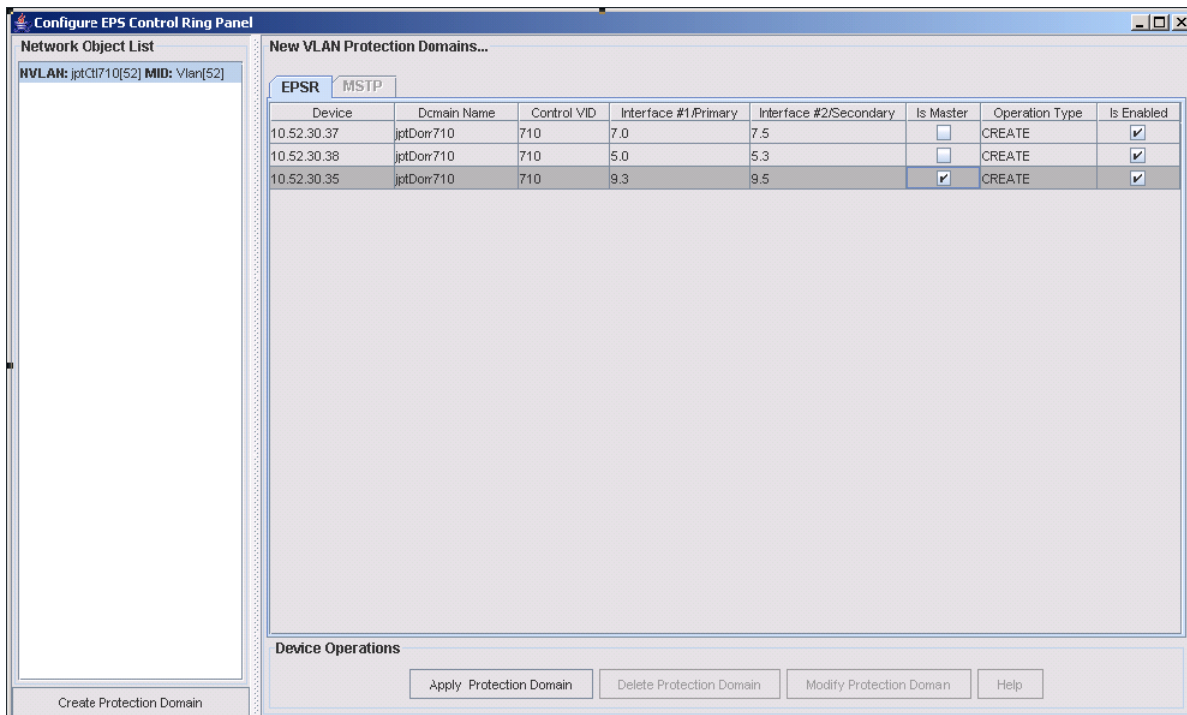

FIGURE 6-148 Create New VLAN Protection Domain (Task List)

The figure above shows the components of the EPSR Domain that are to be created at each node. After the Domain is created, then the VLAN interfaces of the selected loop NVLAN (top left) will be added to the Domain as control VLANs. Click on the “Apply Protection Domain” button to activate the tasks. AlliedView NMS will execute these tasks on each device (called Sub-Tasks) in parallel, and provide progress messages for each Sub-Task, as shown in the following figure.

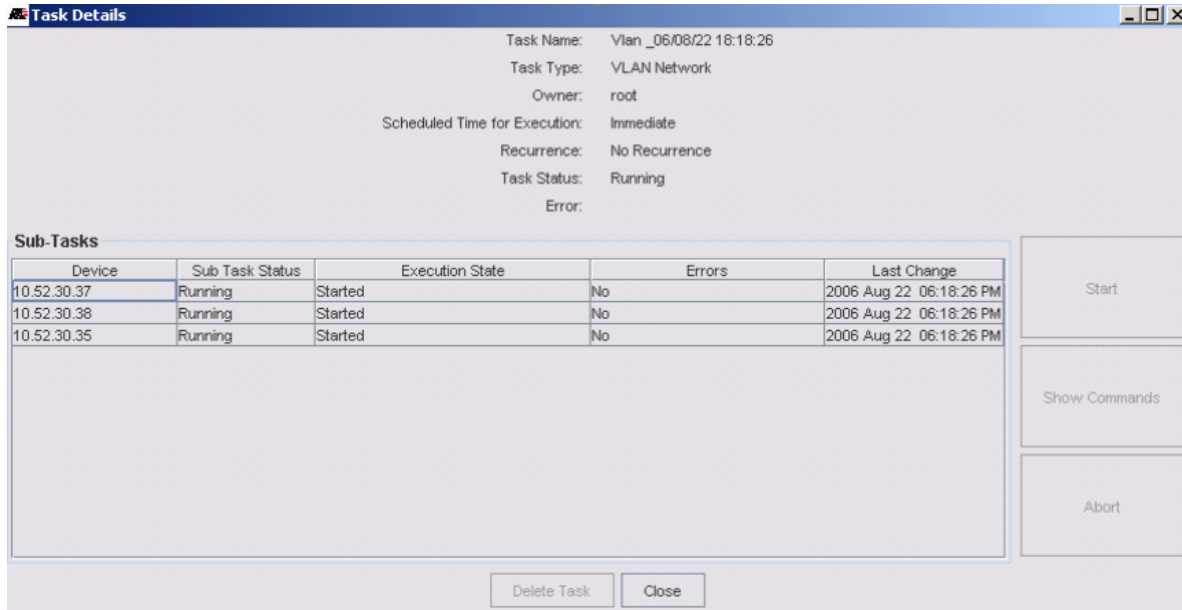

FIGURE 6-149 Task Progress for Creating EPS Ring (part of SuperRing)

When finished, an EPS Ring is created in which all the associated devices have the control VLAN configured on the relevant interface, and one node designated as the Master, as shown in the following figure.

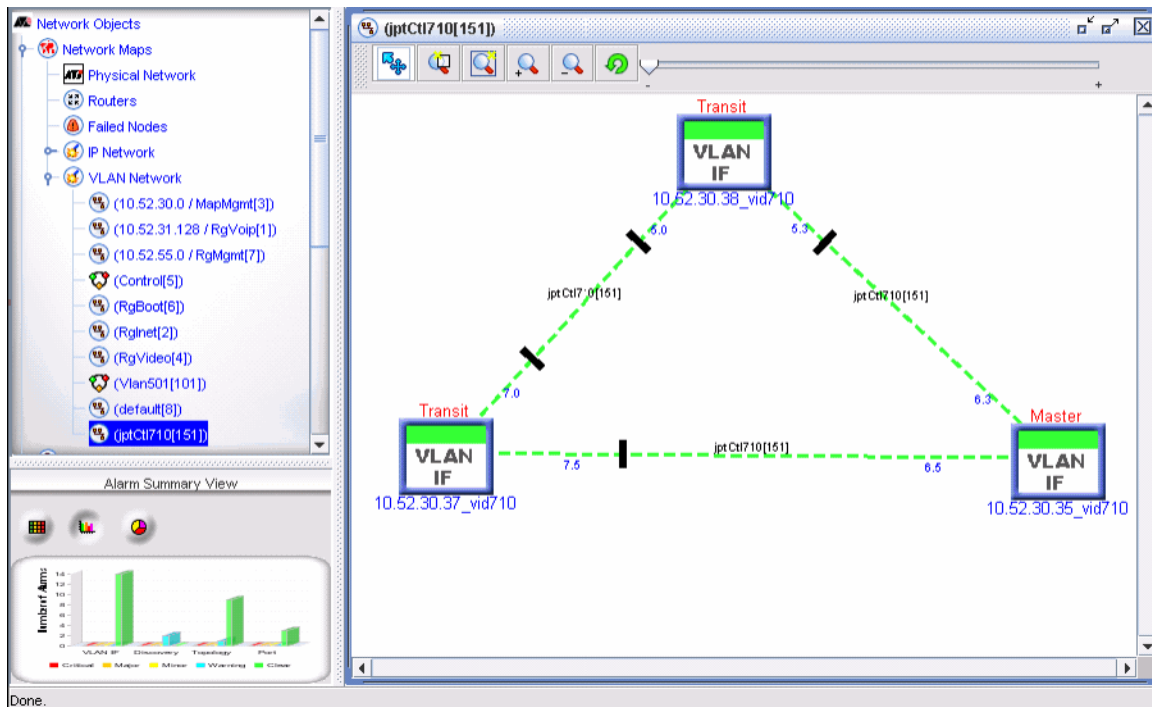

FIGURE 6-150 EPS Ring Created (First Ring of SuperRing)

6.14.2.2 Create Second EPS Ring that is a Peer of First EPS Ring

The steps to create the second, peer EPS Ring are similar to the first. In choosing a looped Network VLAN where there is a shared link with another EPS Ring, the user must put in a non-zero value for the EPSR Priority, and this value must be different than the first ring.

Select the Network VLAN and click on Create Protection Domain. As with the first EPS Ring, the Control VLAN is configured on all of the interfaces and the resulting GUI shows the EPS Ring and which node is Master, as shown in the following figures.

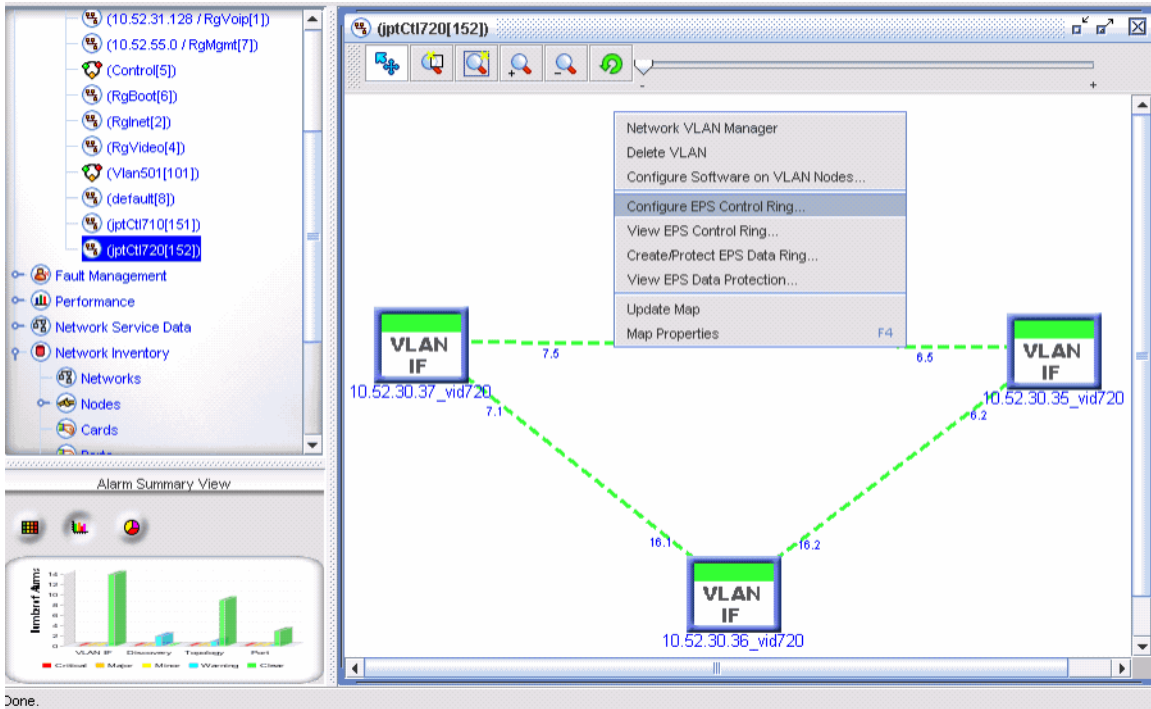

FIGURE 6-151 Configure Peer EPS Ring (to form SuperRing Configuration)

Create New VLAN Protection Domain Dialog

Master Control Ring Properties

Protection Domain Name:

HelloTime (seconds):

FailoverTime (seconds):

RingFlapTime (seconds):

EPSR Priority (0..127):

Create Protection Domain Priority values greater than 0 are for Super EP

Protection Domain Name: The domain name that will be created on the devices.
FailOverTime: Wait time of Master domain before detecting a break in the ring.
HelloTime: The rate at which health control message is sent by master domain.

Ok Cancel

FIGURE 6-152 Configuring the Second EPS Ring with Different EPSR Priority

Finish by selecting OK, and the system will show how the devices will be configured. The user can change the node which will be Master at this point. Refer to the following figure.

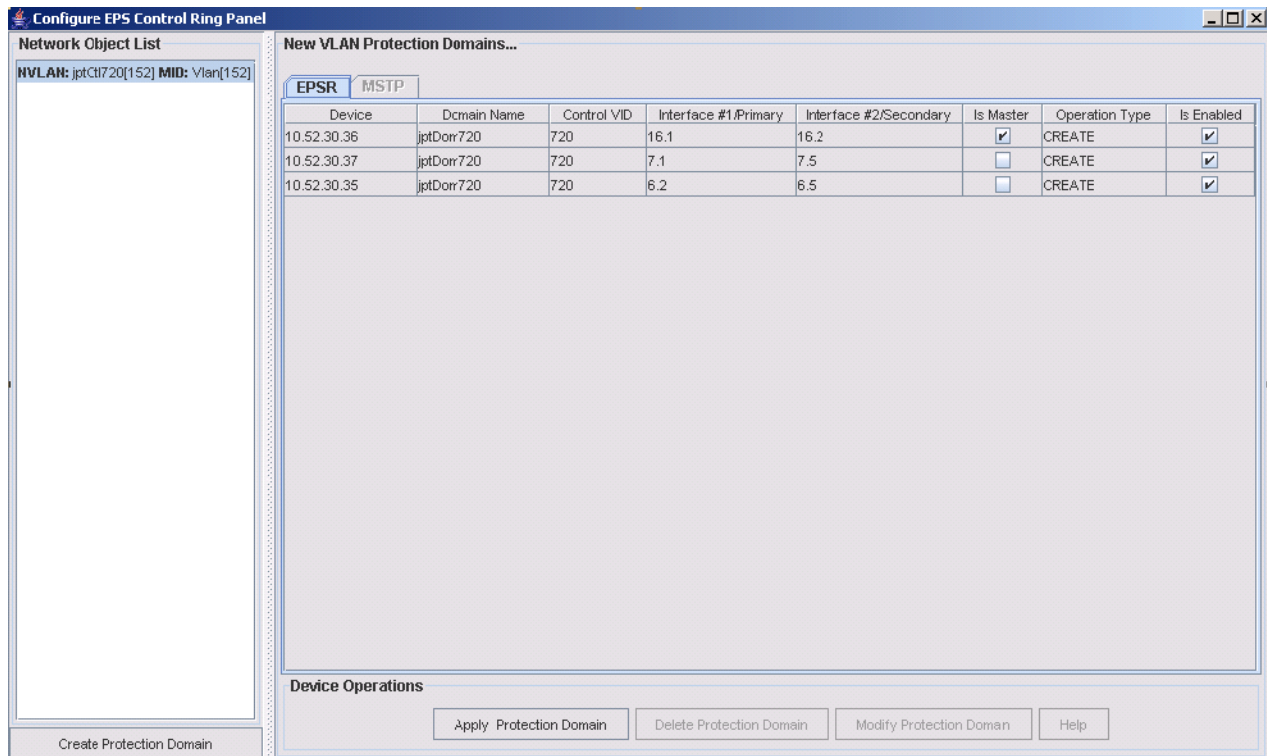

FIGURE 6-153 Configure EPS Control Ring Panel for Second Ring

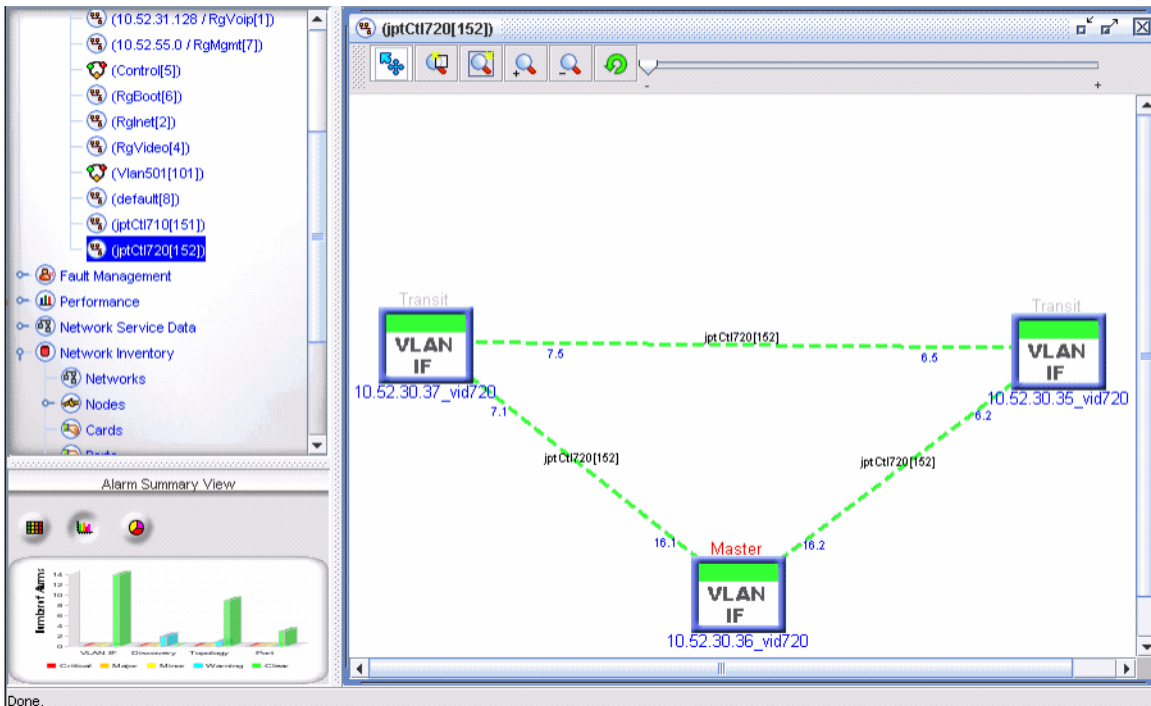

FIGURE 6-154 GUI for Second EPS Ring

The VLAN Link from Port 7.5 on Node 10.52.30.37 to Port 9.5 on Node 10.52.30.35 is now a Shared EPSR Link, since it is also a link of Ring jptCtrl710. **Since the rings jptCtrl720 and jptCtrl710 share a link and both have priorities greater than 0, they are peers forming a Super-Ring.** Also, note that the Transmit Domains are disabled, and they cannot be enabled until the entire SuperRing has at least one Protected VLAN on it.

6.14.2.3 Creating the Protection VLAN

The “Create/Protect EPS Data Ring...” menu item can now be used from **either** of the Peer maps to create a VLAN that follows the Ring nodes, and is a Protected VLAN of the EPS Ring.

To create the Protected VLAN, right click on one of the Control VLAN maps and select “Create/Protect EPS Data Ring”. The Protect Networked-VLAN Panel appears, as shown in the following figures.

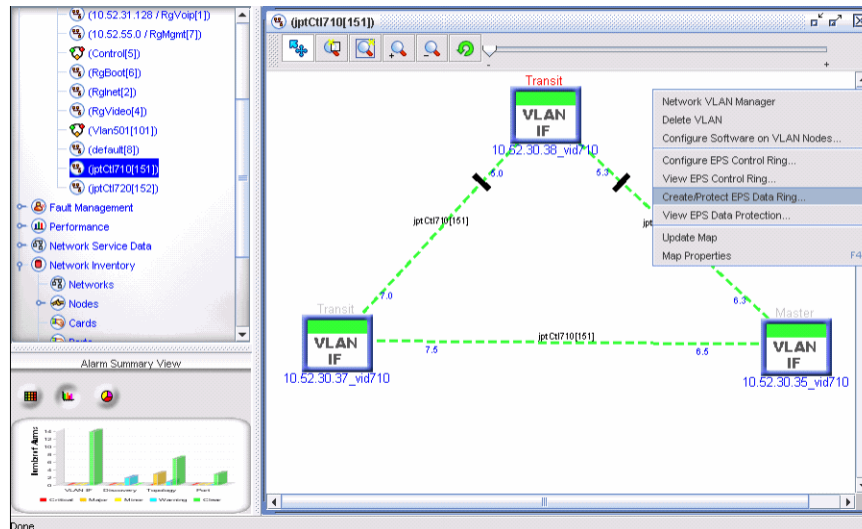

FIGURE 6-155 Selecting Create/Protect EPS Data Ring for the Control VLAN

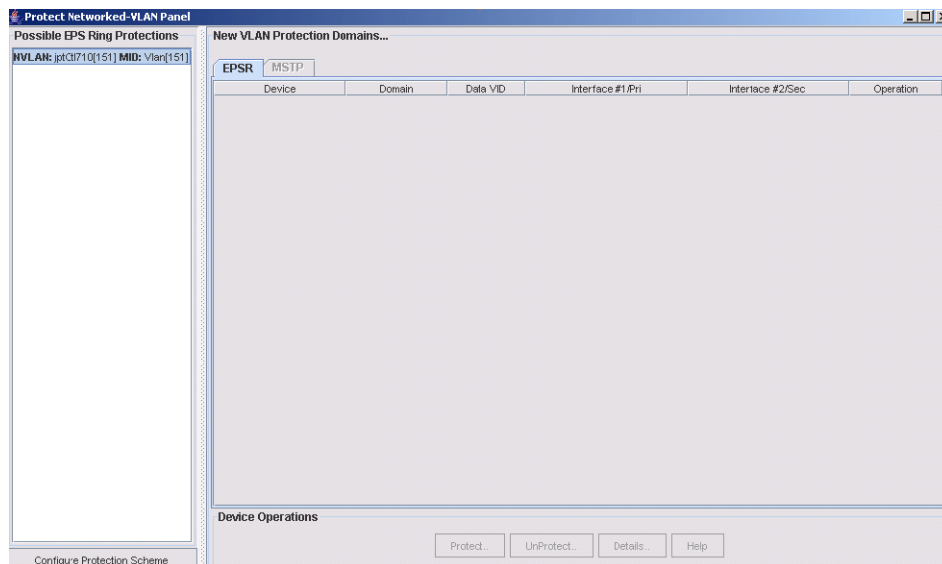

FIGURE 6-156 Selecting Network VLAN to Configure as Protection VLAN

After selecting the EPSR Control NVLAN (at the top left) to use as the protecting domain, click on the “Configure Protection Scheme” button.

Since the VLAN being created will be protected by multiple peer rings of a Super-Ring, the following warning is displayed:

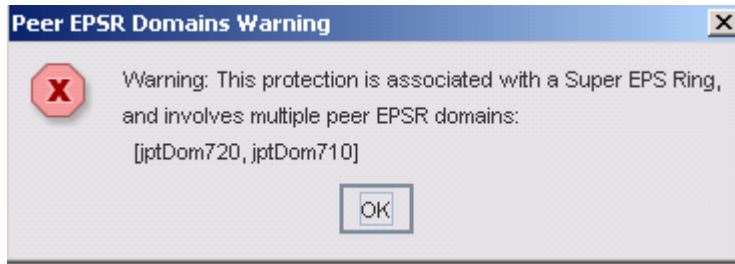

FIGURE 6-157 Creating Second Protected VLAN for SuperRing - Warning

Fill-in the VID and VLAN Name (for new Protected NVLAN to be created) in the resulting menu

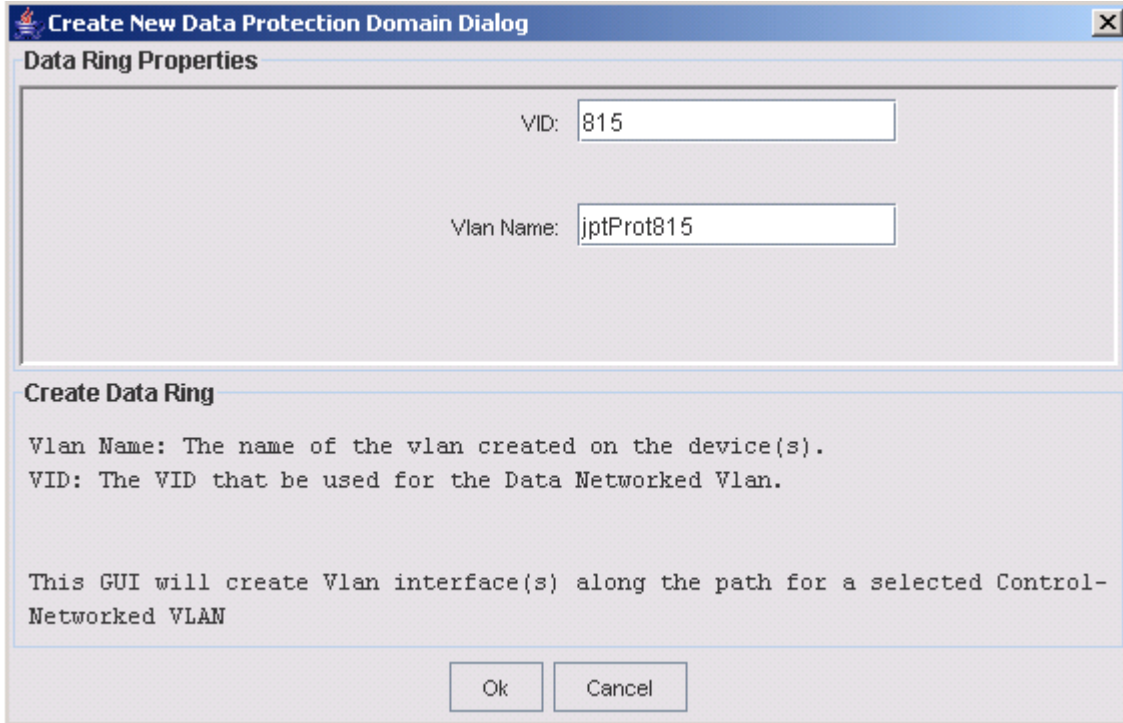

FIGURE 6-158 Configuring the Protected VLAN for Control VLAN

In the above form enter the VLAN ID and the VLAN name. The form notes that this GUI will create the VLAN interfaces along the same path as the Control VLAN. Clicking on OK brings up the Protect Networked-VLAN Panel with the configuration that is going to be created as shown in the following figure.

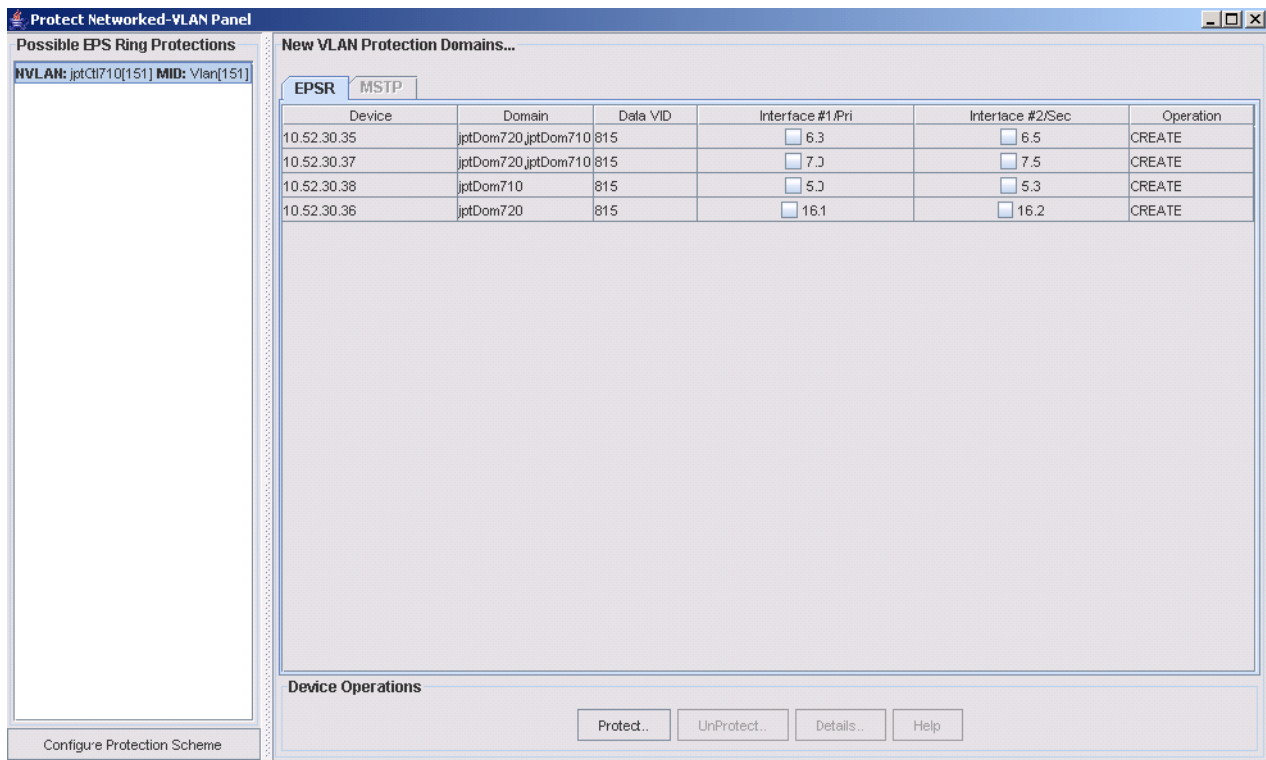

FIGURE 6-159 Creating the Protection VLAN over multi-EPSR Domains

This table displays the components of the Data VLAN that will cause it to be protected by the Domains indicated in the table. Clicking on the “Protect...” button performs the operations on each device to create the jptProt815 NVLAN and put it into the both Peer Domains, jptDom710 and jptDom720, resulting in the following map for jptProt815.

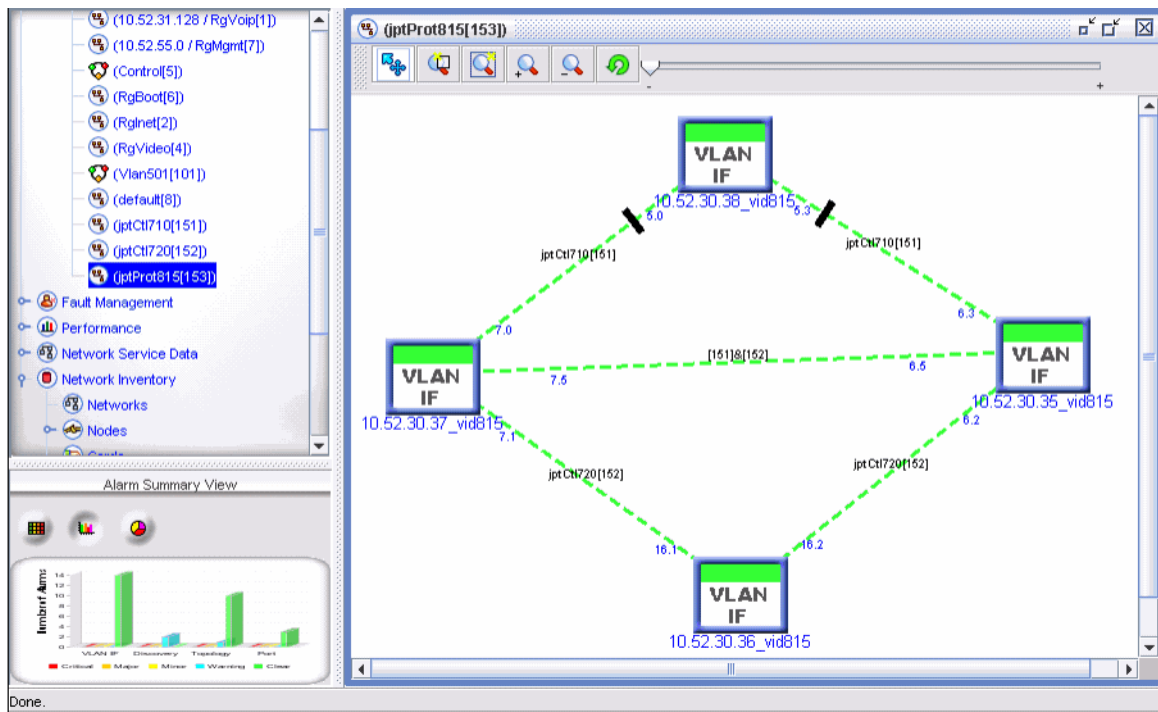

FIGURE 6-160 Superloop Domain

6.14.2.4 Enable the EPS Domains

Now that the SuperRing has at least one Protected VLAN on it, the domains can all be enabled. Select one of the control VLANs and on the map select View EPS Control ring, as shown in the following figure.

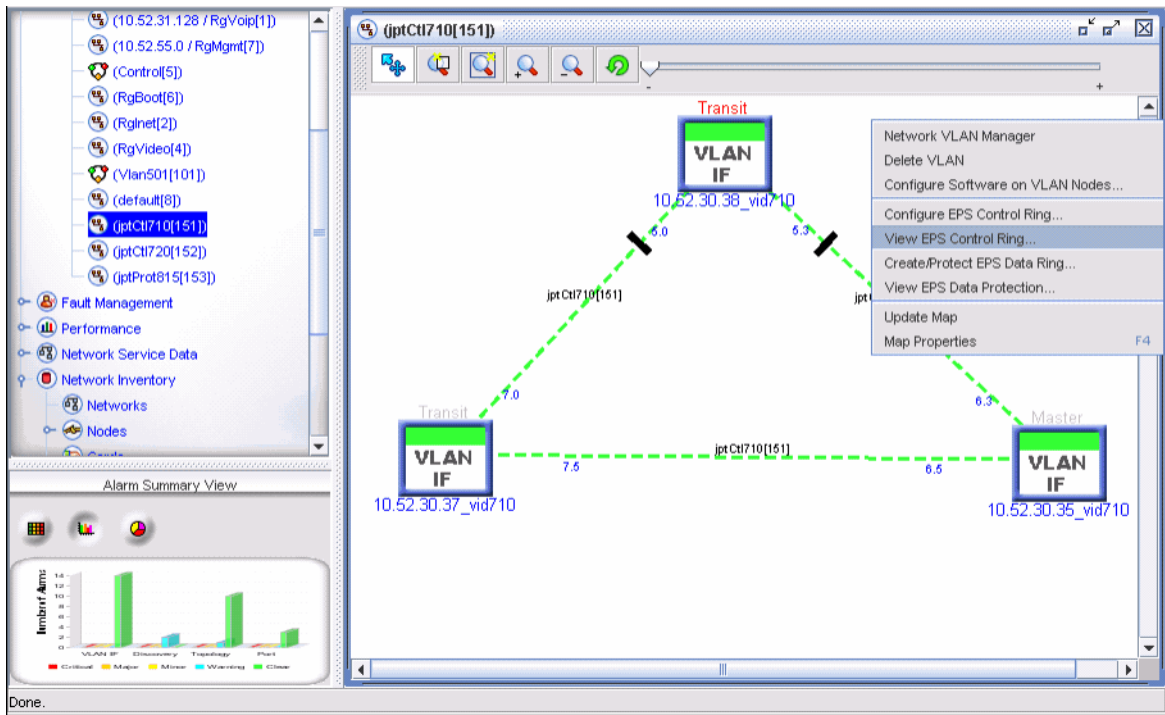

FIGURE 6-161 View one of the EPSR Control Rings

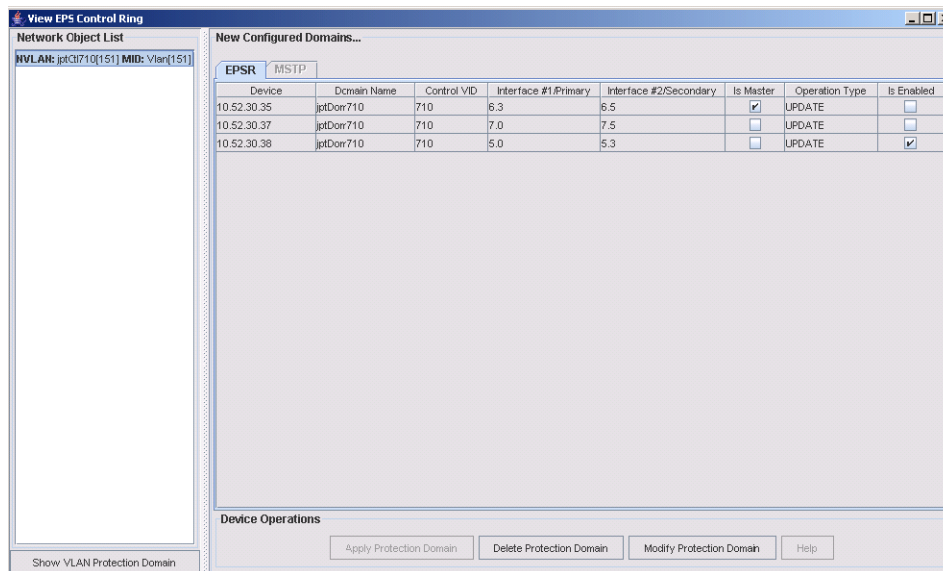

FIGURE 6-162 View one EPS Control VLAN (used to enable Protection Domain)

Click on the tic boxes under **Is Enabled**, and then **Modify Protection Domain**. When this is done this and the other domains become enabled as well, as shown below.

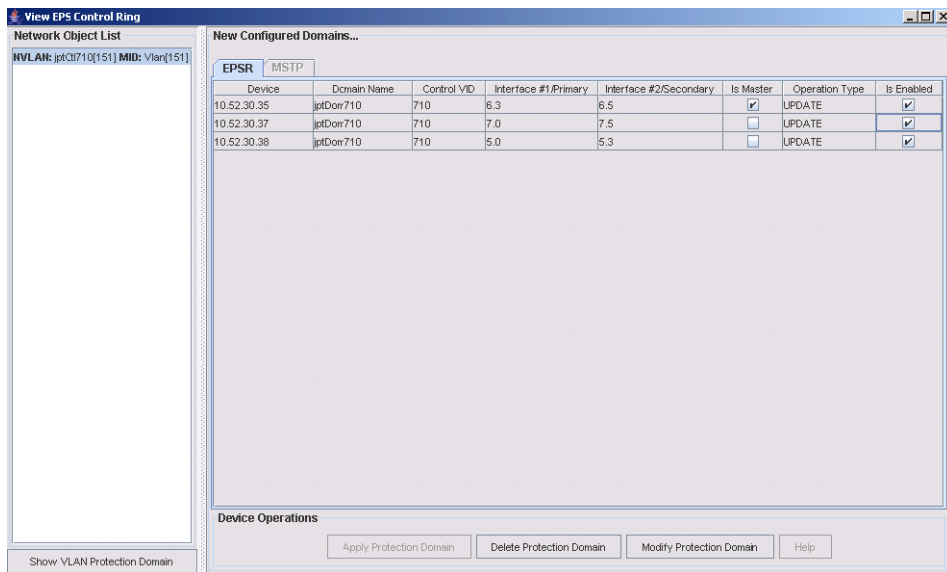

FIGURE 6-163 Protection Domain Enabled

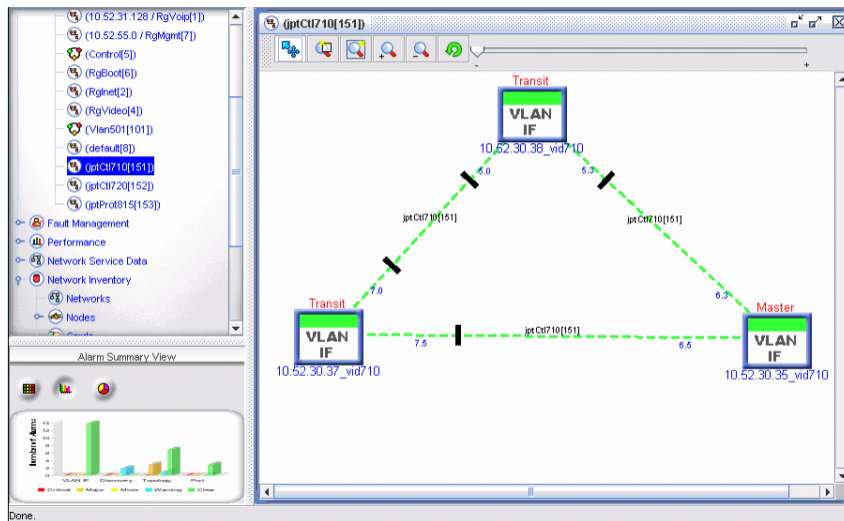

FIGURE 6-164 Enabled Control VLAN (Part of SuperRing)

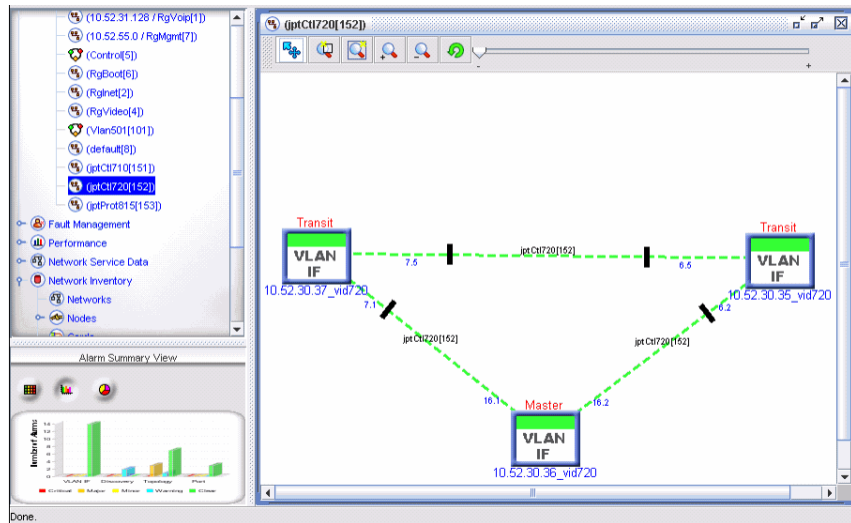

FIGURE 6-165 Enabled Peer Control VLAN (Part of SuperRing)

6.14.2.5 Adding Protected VLANs to the SuperRing

Additional Protected Vlan's can be added to Super-Ring by selecting any one of the EPS Rings that make up the SuperRing, as shown in the following figure.

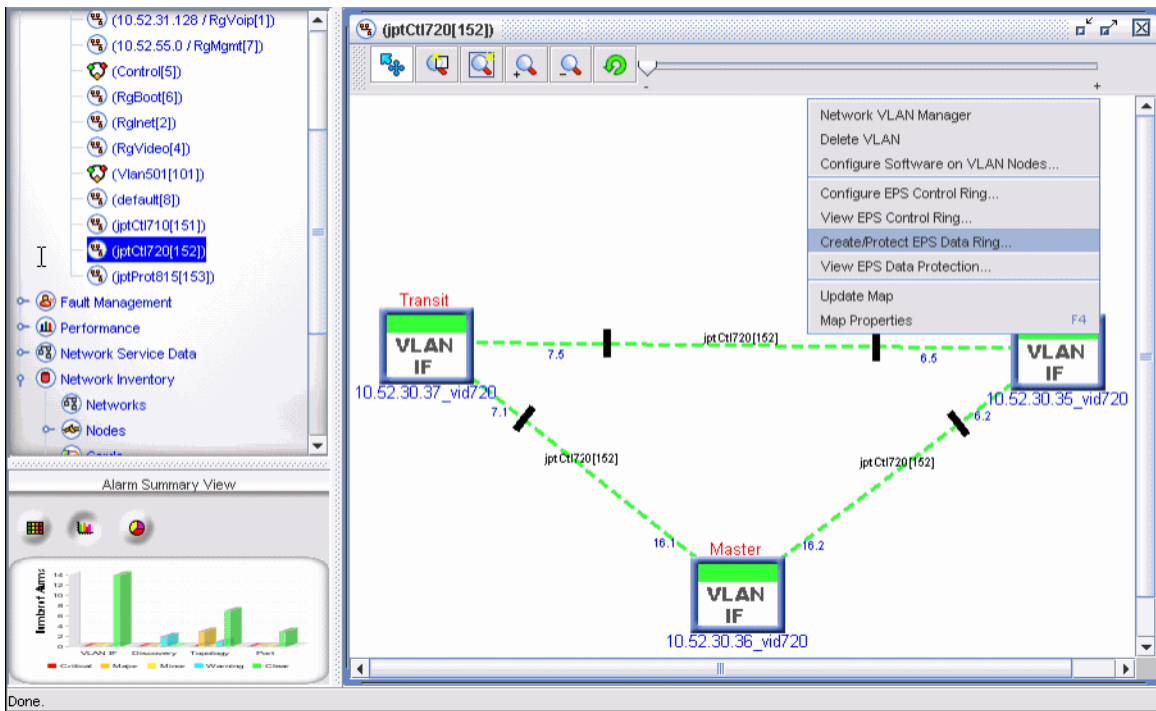

FIGURE 6-166 Creating Second Protected VLAN for SuperRing

A Warning is given to indicate that the data ring will be extended to multiple domains, as shown below.

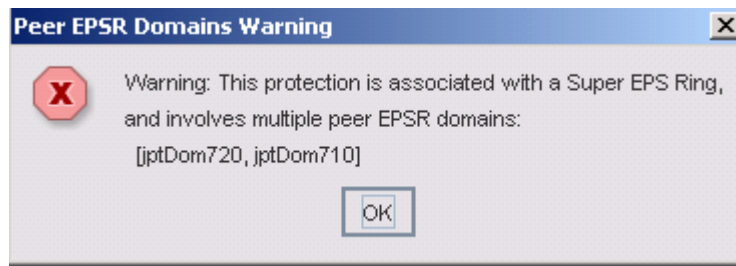

FIGURE 6-167 Creating Second Protected VLAN for SuperRing - Warning

As with the first Protected VLAN, the GUIs lead the user through creating the second Protected VLAN. Note that the Protect Network VLAN Panel shows that all of the nodes of the SuperRing will have the VLAN added, as shown in the following figures.

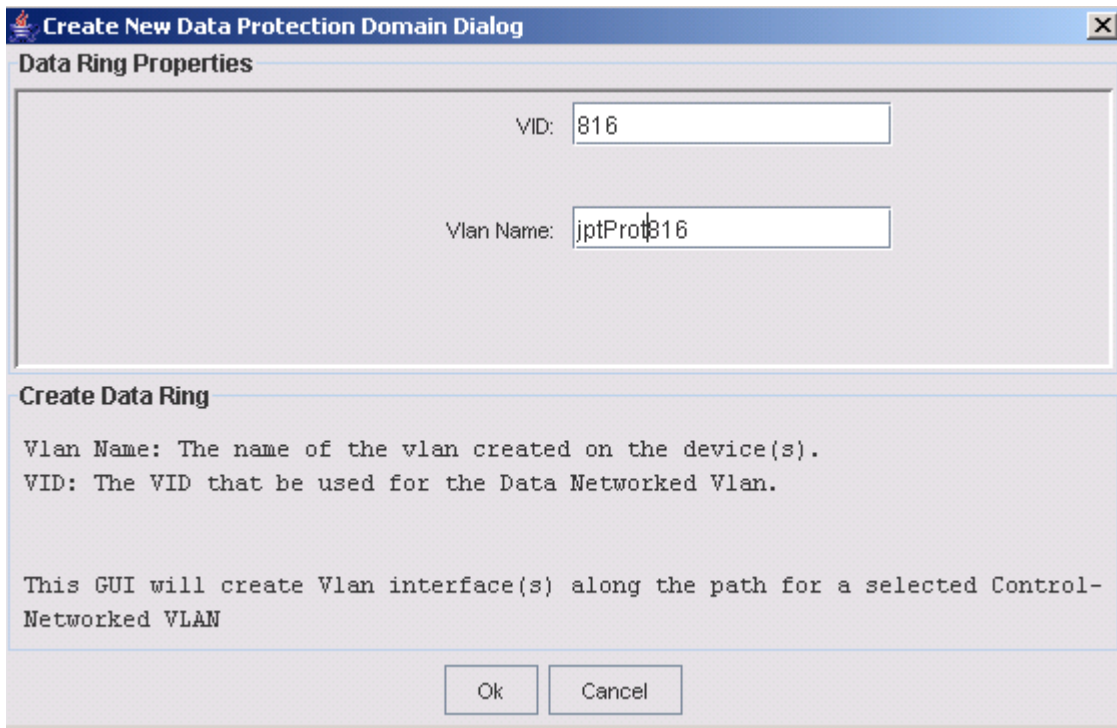

FIGURE 6-168 Creating Second Protected VLAN for SuperRing

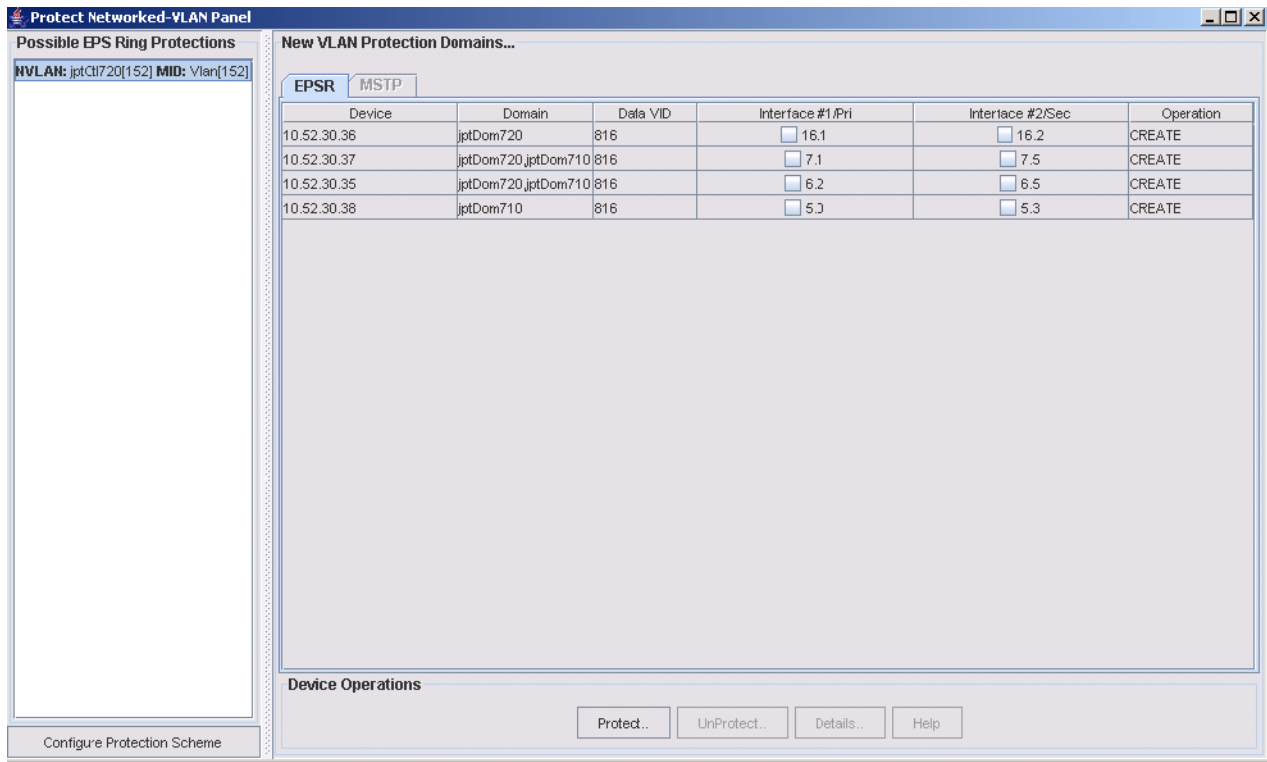

FIGURE 6-169 Task List showing Protected VLAN extends to all Nodes in SuperRing

Selecting the Control VLAN in the left panel and then Configure Protection Scheme will take the Second Protected VLAN (816) and extend it over the entire SuperRing. When the Protected VLAN is created and the user clicks on the leaf for VLAN 816, all the nodes of the two EPS Rings are included, as shown in the following figure.

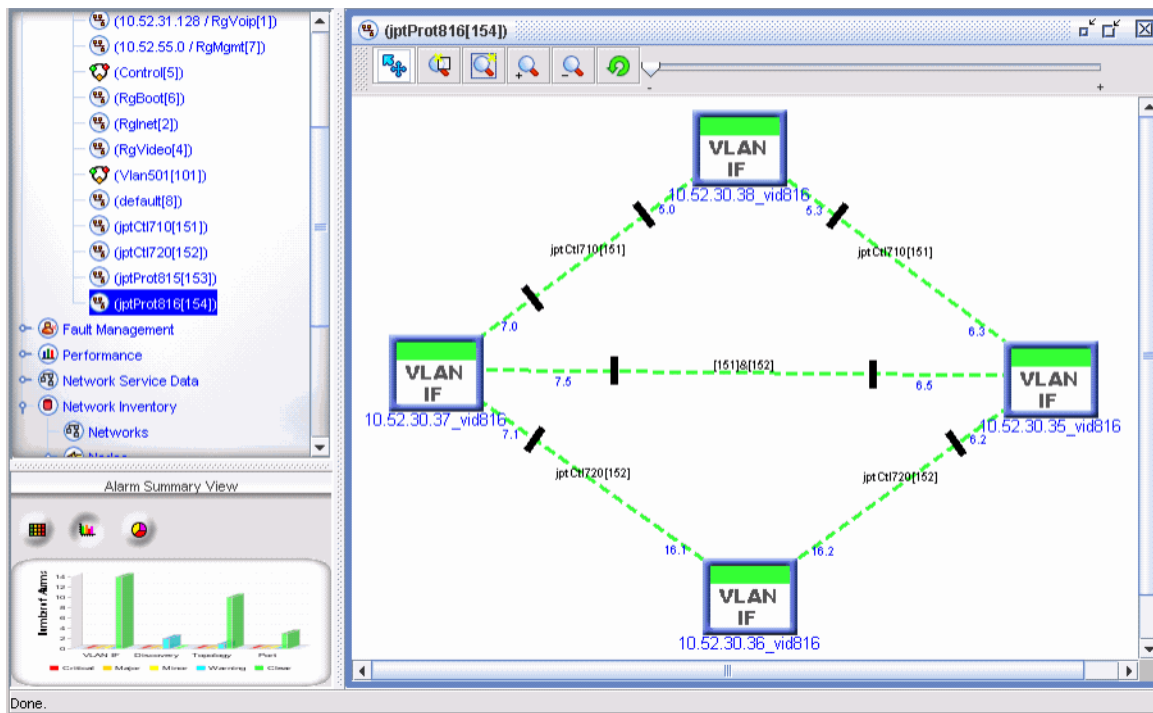

FIGURE 6-170 Protected VLAN across Multiple EPS Control VLANs (816)

6.14.2.6 Viewing Network Inventory

The Network Inventory View shows the status of the SuperLoop, as shown in the following figure.

Domain Name	Domain State	Type	Ctrl VID	Pri Ifc	PI State	PI Prio	Sec ...	SI State	SI Prio	Status
PD-10.52.30.34--jctDom501	LINKS-UP	EPSR-Transit	501	1.0	FORWARDING	0	1.1	FORWARDING	0	ENABLED
PD-10.52.30.34--NmsRing	LINKS-UP	EPSR-Transit	500	1.0	FORWARDING	0	1.1	FORWARDING	0	ENABLED
PD-10.52.30.35--jctDom501	LINKS-UP	EPSR-Transit	501	1.0	FORWARDING	0	1.1	FORWARDING	0	ENABLED
PD-10.52.30.35--jctDom710	FAILED	EPSR-Master	710	6.3	FORWARDING	126	6.5	FORWARDING	126	ENABLED
PD-10.52.30.35--jctDom720	LINK-DOWN	EPSR-Transit	720	6.2	BLOCKED	125	6.5	BLOCKED	125	ENABLED
PD-10.52.30.35--NmsRing	LINKS-UP	EPSR-Transit	500	1.0	FORWARDING	0	1.1	FORWARDING	0	ENABLED
PD-10.52.30.36--jctDom501	COMPLETE	EPSR-Master	501	6.2	FORWARDING	0	6.1	BLOCKED	0	ENABLED
PD-10.52.30.36--jctDom720	FAILED	EPSR-Master	720	16.1	FORWARDING	125	16.2	FORWARDING	125	ENABLED
PD-10.52.30.36--NmsRing	COMPLETE	EPSR-Master	500	6.1	FORWARDING	0	6.2	BLOCKED	0	ENABLED
PD-10.52.30.37--jctDom710	LINK-DOWN	EPSR-Transit	710	7.0	BLOCKED	126	7.5	BLOCKED	126	ENABLED
PD-10.52.30.37--jctDom720	LINK-DOWN	EPSR-Transit	720	7.1	BLOCKED	125	7.5	BLOCKED	125	ENABLED
PD-10.52.30.38--jctDom710	LINK-DOWN	EPSR-Transit	710	5.0	BLOCKED	126	5.3	BLOCKED	126	ENABLED

FIGURE 6-171 Network Inventory for EPSR Domains

6.15 Customer Management

6.15.1 Overview

Provisioning services for customers usually involves setting the values of many parameters that vary depending on the type of service customers have requested, the service features to be provided, and the components to be configured. The Network Service applications available using the AlliedView NMS, such as Profiles and Quality of Service Policies, allow ports on the devices to be configured efficiently and without errors. The Customer Management feature allows individual customers to have their type of service configured, and incorporates these Network Service applications as well. This allows almost all customer attributes for any service to be included on one form.

Moreover, once one customer has been provisioned, these same attributes can be carried over in provisioning new customers. Finally, almost all attributes for a customer can be modified by selecting the **View/Modify Customer Ports Form**.

The following figure shows the options available. To access Customer Management, select **Tools -> Customer Management**.

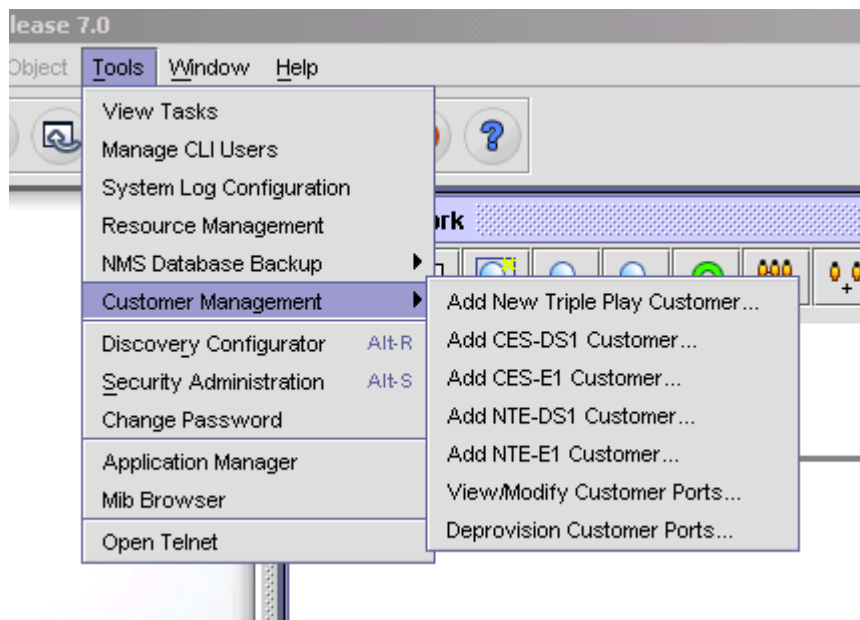

FIGURE 6-172 Accessing the Customer Management Options

6.15.2 Add New Triple Play Customer - Four Examples

The **Provision New Triple Play Customer** Form is used to provision on one form most of the attributes needed for one customer.

Note: The fields of the Provision New Triple Play Customer Form are described in 5.6.3.

The form is divided into three main panels:

1. Video/Data Configuration
2. Voice Configuration
3. Derived Voice

Using this form is an efficient and error-free method to data fill a customer, and this becomes even more true when used in conjunction with Profiles, explained in 6.10.

Figure 6-182 shows four example configurations for triple play

1. POTS24 for analog voice only - This is for an analog phone or modem.
2. POTS24 and ADSL for analog voice and video/data- This is using a Residential Gateway and the ADSL/POTS24 cards.
3. Ethernet - This is using a Residential Gateway and the FE10 card for digital voice and data/video
4. ADSL - This is for analog voice and data.

Following this figure are the **Provision New Triple Play Customer** Forms and how they would be filled out for each configuration.

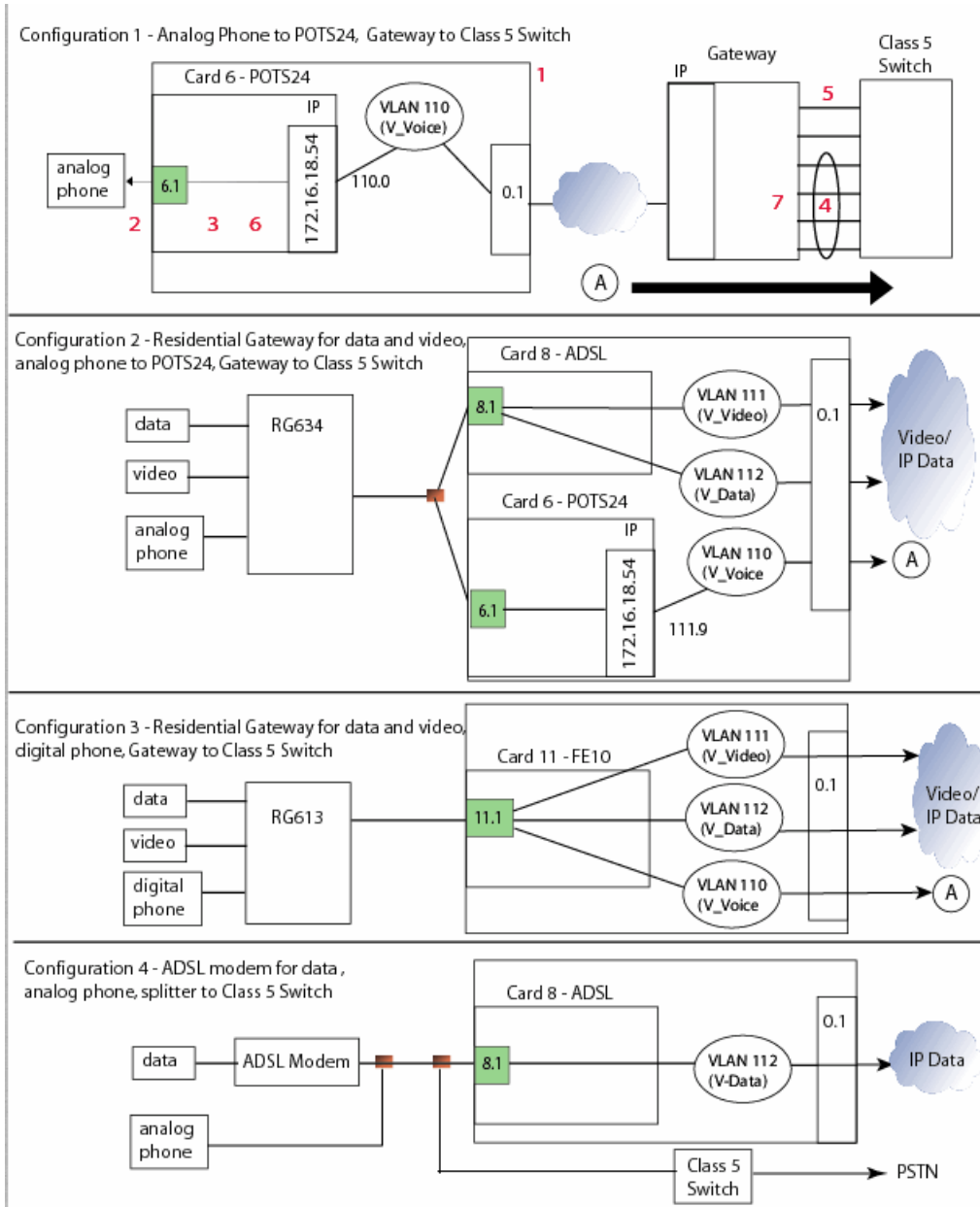

FIGURE 6-173 Four Example Configurations for Triple Play

6.15.2.1 Configuration 1 - POTS24 Only

In this scenario, only the middle panel (Voice Configuration) is filled in. The POTS Call Agent is filled in automatically when the POTS GW IP Addr. (the IP address for the POTS24 card) and the port is filled in. The Line Profile, a GW attribute, is available once the Gateway has been configured.

Note: In this figure, the underlined numbers in the fields match the Configuration 1 numbers in Figure 6-173.

Provision New Triple Play Customer

Description (Customer ID): analog_only

Video/Data Configuration

Access Device: [] Slot Port: [] Port Profile: []

VLAN Settings:

Untagged VLAN: 1 Tagged VLAN(s): []

Allowed STB MAC Adrs:

STB #1: [] STB #2: []

STB #3: [] STB #4: []

STB #5: [] STB #6: []

IP Filtering: IP Addr/Mask (e.g. 192.4.1.0/255.255.255.0)

Allowed Range #1: [] Allowed Range #2: []

Allowed Range #3: [] Allowed Range #4: []

Allowed Range #5: [] Allowed Range #6: []

Voice Configuration

POTS:

POTS Access Device: 172.16.33.11 1 Slot Port: 6.1 2 POTS Port Profile: Standard 6

POTS Call Agent: 192.168.101.10 3 Interface Group: 1 4 CRV: 45 5 Line Profile: g711 7

Derived Voice:

Gateway: [] Call Agent: []

Line #1: Gateway Port: [] Interface Group: [] CRV: [] Line Profile: []

Line #2: Gateway Port: [] Interface Group: [] CRV: [] Line Profile: []

Line #3: Gateway Port: [] Interface Group: [] CRV: [] Line Profile: []

Schedule

Now Hold Schedule: Jan 30, 2005 9 25 PM

Provision Recent Commands... Close Help

FIGURE 6-174 Triple Play Form - POTS24 Only

6.15.2.2 Configuration 2 - POTS24 and ADSL Card, Analog Phone Only

In this configuration, an analog phone, data, and video are provided using an ADSL card and a separate POTS24 card that are combined using the Customer ID. (The POTS24 and ADSL card can be on separate systems if needed). The top and middle panels are filled in.

Provision New Triple Play Customer

Description (Customer ID): TP_analog_phone

Video/Data Configuration

Access Device: 172.16.33.11 Slot Port: 8.1 Port Profile: Gold (ADSL)

VLAN Settings:
 Untagged VLAN: 1 Tagged VLAN(s):

Allowed STB MAC Addr:
 STB #1: 00:11:22:33:44:56 STB #2:
 STB #3: STB #4:
 STB #5: STB #6:

IP Filtering: IP Addr/Mask (e.g. 192.4.1.0/255.255.255.0)
 Allowed Range #1: 192.168.25/32 Allowed Range #2:
 Allowed Range #3: Allowed Range #4:
 Allowed Range #5: Allowed Range #6:

Voice Configuration

POTS:
 POTS Access Device: 172.16.33.11 Slot Port: 6.1 POTS Port Profile: Standard
 POTS Call Agent: 192.168.101.10 Interface Group: 1 CRV: 46 Line Profile: g711

Derived Voice: Gateway: Call Agent:
 Line #1: Gateway Port: Interface Group: CRV: Line Profile:
 Line #2: Gateway Port: Interface Group: CRV: Line Profile:
 Line #3: Gateway Port: Interface Group: CRV: Line Profile:

Schedule

Now Hold Schedule: Jan 30, 2005 9 25 PM

Provision Recent Commands... Close Help

FIGURE 6-175 Triple Play Form - POTS24 and ADSL Card, Analog Phone Only

6.15.2.3 Configuration 3 - FE10 Card, Digital Phone Only, Video and Data

In this configuration, an iMAP 9000 is used, and using the FE card video and data are configured as well as a digital phone. The top and bottom panels are used, with the Gateway for the Derived Voice the IP Address on the Gateway Device.

Provision New Triple Play Customer

Description (Customer ID): TP_digital_phone

Video/Data Configuration

Access Device: 172.16.33.20 Slot Port: 11.1 Port Profile: Platinum (Etherlike Port)

VLAN Settings:
 Untagged VLAN: Tagged VLAN(s):

Allowed STB MAC Adrs:
 STB #1: 00:24:36:57:32:45 STB #2:
 STB #3: STB #4:
 STB #5: STB #6:

IP Filtering: IP Addr/Mask (e.g. 192.4.1.0/255.255.255.0)
 Allowed Range #1: Allowed Range #2:
 Allowed Range #3: Allowed Range #4:
 Allowed Range #5: Allowed Range #6:

Voice Configuration

POTS:
 POTS Access Device: Slot Port: POTS Port Profile:
 POTS Call Agent: Interface Group: CRV: Line Profile:

Derived Voice: Gateway: 172.16.33.112 Call Agent: 192.168.101.10
 Line #1: Gateway Port: 0 Interface Group: 1 CRV: 47 Line Profile: g711
 Line #2: Gateway Port: 1 Interface Group: 1 CRV: 48 Line Profile: g711
 Line #3: Gateway Port: Interface Group: CRV: Line Profile:

Schedule

Now Hold Schedule: Jan 30, 2005 9 25 PM

Provision Recent Commands... Close Help

FIGURE 6-176 FE10 Card, Digital Phone Only, Video and Data

6.15.2.4 Configuration 4 - ADSL for Data and Analog Phone with Splitter

In this configuration, only the top panel is filled out for the data service, since the phone service is split off from the iMAP device and goes to the Class 5 device.

Provision New Triple Play Customer

Description (Customer ID):

Video/Data Configuration

Access Device: Slot Port: Port Profile: (ADSL)

VLAN Settings:
 Untagged VLAN: Tagged VLAN(s):

Allowed STB MAC Adrs:
 STB #1: STB #2:
 STB #3: STB #4:
 STB #5: STB #6:

IP Filtering: IP Addr/Mask (e.g. 192.4.1.0/255.255.255.0)
 Allowed Range #1: Allowed Range #2:
 Allowed Range #3: Allowed Range #4:
 Allowed Range #5: Allowed Range #6:

Voice Configuration

POTS:
 POTS Access Device: Slot Port: POTS Port Profile:
 POTS Call Agent: Interface Group: CRV: Line Profile:

Derived Voice:
 Gateway: Call Agent:
 Line #1: Gateway Port: Interface Group: CRV: Line Profile:
 Line #2: Gateway Port: Interface Group: CRV: Line Profile:
 Line #3: Gateway Port: Interface Group: CRV: Line Profile:

Schedule

Now Hold Schedule:

FIGURE 6-177 ADSL for Data, Analog Phone with Splitter

6.15.3 Add DS1/E1 Customer

This is part of provisioning a CES customer, and brings up the Provision New DS1/E1 Port Form. The fields on this form are explained in 5.6.6. A configuration with example values is shown in 6.16.3.

6.15.4 View/Modify Customer Ports

The **Find Subscriber/Ports Form** is a powerful tool that allows the user to search, display, and change customer port attributes, and can help highlight when a Customer ID name is not appropriate.

To access the Find Subscriber/Ports Form, select from the main menu *Tools -> Customer Management -> View/Modify Customer Ports*. The Find Subscriber/Ports Form appears. Input a Customer ID, and the associated port(s) appear, as shown in the following figure.

Note: The "*" can be used as a wild card to search for customer IDs that match patterns.

Customer ID (ex. *Joe Smith*): x3112 Customer Info (ex. *Main St.*): Search

iMG/RGs

Customer ID	Current IP Address	Access Device/Port

Data Ports

Customer ID	Device	Port	Type
x3112	10.52.30.1	39	Ether-like

Voice Ports

Customer ID	Device	Port	Type

View/Modify Details Close Help

FIGURE 6-178 Find Subscriber/Ports Form

Once the port(s) appear, the user can either double-click a port or select the port and click on **View/Modify Details** to bring up the relevant Port Management Form, where attributes can be viewed and modified.

Note: The *View/Modify Details* button is enabled when one entry is selected.

By searching on the Customer ID, the user can quickly find the relevant services/ports that are being used for a customer and can quickly view the current attributes and make any changes.

Caution: *Customer IDs should be unique and should apply to one customer line. The one exception is with the dual CES configuration, explained below.*

Proper use of a customer ID is important because it helps the administrator understand how the services/ports have been configured. For example, in a CES dual endpoint configuration (explained in 6.16), each DS1 port has the same customer ID or label. In the following figure, the name for each endpoint is ds1_dual. However, a third DS1 endpoint has also been given the customer ID of ds1_dual, so one of the ports is not part of the dual endpoint configuration. By viewing the details of each port and looking at the actual values for each one (especially the IP and UDP values at the PSPAN level), the user can determine which ports are actually connected and then rename the third DS1 port to something more appropriate.

(It is possible that all three DS1 ports could have been single endpoints, but the purpose of the customer ID is to use names that match the configuration and therefore allow easy recognition of what the customer has.)

Customer ID:

Data Ports

Customer ID	Device	Port	Type
ds1_dual	172.16.33.18	5.1	DS1
ds1_dual	172.16.33.18	7.0	DS1
ds1_dual	172.16.33.18	5.0	DS1

Voice Ports

Customer ID	Device	Port	Type
-------------	--------	------	------

FIGURE 6-179 Ambiguous Use of Customer ID

6.15.5 Deprovision Customer Ports

This form allows the user to quickly find the ports/voice lines associated with a subscriber ID and deprovision them.

*Note: This form can also be accessed from the Port Inventory or Port Management main screen by right-clicking on the relevant port and selecting **De-Provision Customer/Port**.*

After selecting the appropriate ports/lines, the user can deprovision the port/line immediately or at a scheduled time. The figures below show the following:

- A customer that has both an ADSL and POTS card provisioned. The ports are shown in the Ports panel while the associated Voice Lines are shown in the Voice Lines Panel.
- A dual-endpoint CES connection. Note that the use of the Customer ID is correct, as the one ID is used to identify the two (and only two) associated ports.

Customer ID: Search

iMG/RGs

Customer ID	IP Address	Access Device/Port

Reset RG/iMGs to Factory Defaults

Ports

Customer ID	Device	Port	Type
scott ADSL A	10.52.68.70	8.23	POTS
scott ADSL A	10.52.68.70	10.23	ADSL

Voice Lines

Customer ID	Call Agent	IG	CRV	Gateway	Port

De-provision Select All Recent Commands... Close Help

FIGURE 6-180 De-provision Ports Form - ADSL/POTS

Customer ID: Search

Ports

Customer ID	Device	Port	Type
sample_ds1	172.16.33.20	6.0	DS1
sample_ds1	172.16.33.20	6.1	DS1

Voice Lines

Customer ID	Call Agent	IG	CRV	Gateway	Port

Schedule

Now Hold Schedule: Dec 9, 2004 11 24 AM

De-provision Select All Recent Commands... Close Help

FIGURE 6-181 De-provision Ports Form - DS1 Endpoints (CES)

6.16 Circuit Emulation Service

6.16.1 Overview (CES8 and iMG6x6MOD Configurations)

Circuit Emulation is a service that is provided by Allied Telesis using the following:

- CES8 card - The CES8 card is used to provide “Pass-thru” Circuit Emulation Service for both E1 and DS1 circuits

Note: Refer to 5.5.14 and 5.6.20 for an overview of the CES8 card and DS1/E1 port attributes.

The CES configuration can be either single or dual port; in a dual port configuration both ends of the CES circuit are iMAP DS1/E1 ports managed by the NMS, while in a single port configuration, only one DS1/E1 port is configured on an iMAP device managed by the NMS.

- iMG6x6MOD - With the iMG6x6MOD, a circuit emulation service can also be provided. The DS1/E1 port on the iMG can connect to either a CES8 card or another iMG6x6MOD.

The first part of this section will focus on the CES8 to CES8 card configurations, and includes connections between CES8 cards on the same iMAP as well as different iMAPs.

The second part of this section will focus on the iMG6x6MOD and highlights an iMG6x6MOD with connections to ports on the CES8 card, with one port to the public voice switching and the other to a PBX/Channel Bank.

6.16.2 CES8 Configuration - Overview of Steps

The steps for provisioning the CES ports are basically the same regardless of whether single or dual port is being configured:

1. Create the Card (this includes provisioning all ports as DS1 or E1) - Refer to 6.16.3
2. Add the IP interface to the card (this includes the VLAN)
3. Create the port profile - Refer to 6.16.4
4. Provision the port - This will also provision the PSPAN and connect the PSPAN to the port. - Refer to 6.16.5

The following figure shows an example configuration using DS1 ports. (E1 ports are similar.) The detailed steps show how the forms are used.

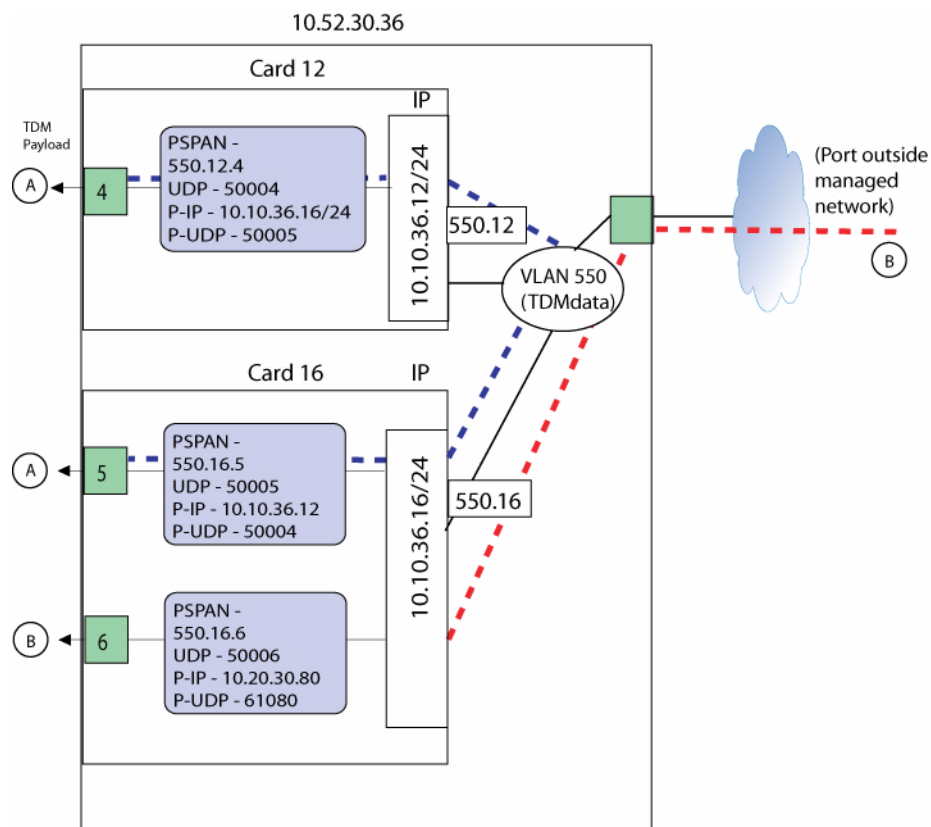

FIGURE 6-182 CES8 Card Configuration

6.16.3 Create/Provision CES8 card to Support DS1 Ports (Same Device)

The following steps are followed to create a connection between two ports on different cards in the **same** device, In Figure 6-182, this would be the A to A connection. (The B to B connection is for a port that is connected to a port that is outside the managed network.)

Note: The two ports can also be on different devices in the same managed network.

To create the cards (if this hasn't been done already), go to the **Card Management Form**, find the Slot (in this case 12) that is not provisioned, and select **Create Card**. Select the Profile as AutoProv if you wish the card to use the load that is in the AutoProv profile, the Admin State as UP (assuming you want the card to go into service), and the Ports Type as DS1. Click on **Create**, and the card status will change in the Card Management form to a Card Type of CES8.

At this point you can download any CES8 files if the Profile was set to Manually Provisioned.

To provision the IP interface, select the card and View Details, and in the CES8 Card Details Form, select the Protocols tab. Fill in the required VLAN, IP Address, and Subnet Mask fields, and the optional fields if needed. Select Modify and the values are applied.

The following figure shows the card on device 10.52.30.36, slot 12, with the values filled for the Protocols tab.

The same procedure is repeated for the card in slot 16.

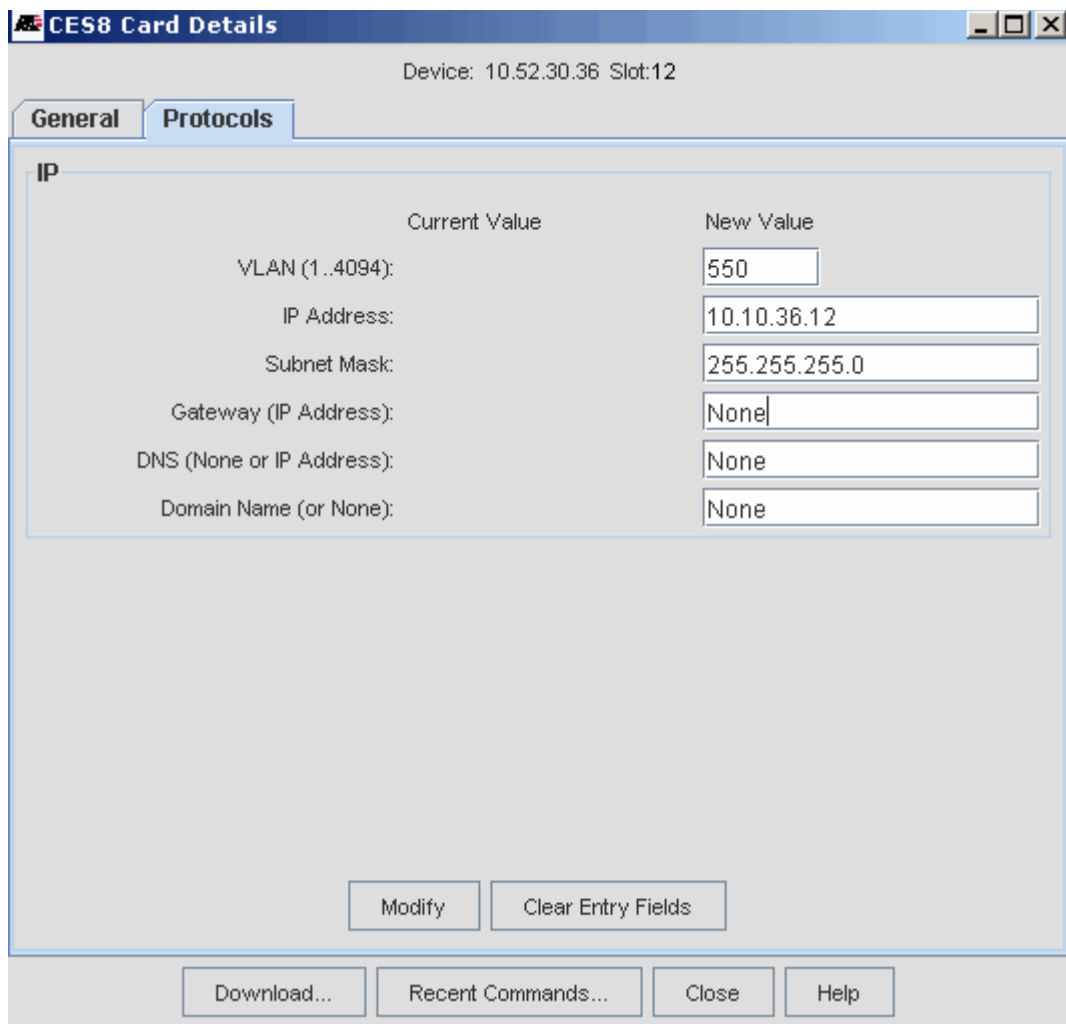

The screenshot shows a web-based interface titled "CES8 Card Details" for a device at 10.52.30.36, slot 12. The "Protocols" tab is active, displaying an "IP" configuration section. This section contains a table with two columns: "Current Value" and "New Value". The "New Value" column contains input fields for various parameters. Below the table are "Modify" and "Clear Entry Fields" buttons. At the bottom of the form are "Download...", "Recent Commands...", "Close", and "Help" buttons.

	Current Value	New Value
VLAN (1..4094):		550
IP Address:		10.10.36.12
Subnet Mask:		255.255.255.0
Gateway (IP Address):		None
DNS (None or IP Address):		None
Domain Name (or None):		None

FIGURE 6-183 Setting the IP Interface for the CES8 Card

Note: At this point, the card attribute Ports Type for the General Tab can be changed, but the card would need to be disabled, and there is a warning about the need to disable the card. The Profile can also be changed, and there is a warning that such a change will destroy existing provisioning data.

6.16.4 Create DS1 Profile (DS1 and P-SPAN)

When a DS1 port is provisioned, a DS1 profile must already exist so it can be associated with the DS1 port. An overview of Profiles is in 6.10. In this example a profile called ds1_profile is created. The following figures show creating the profile. (Once created, they can be viewed in the Profile table by double-clicking on the profile row.)

The screenshot shows the 'Create Profile' dialog box with the following configuration:

- Profile Name: ds1_profile
- Profile Type: CES-DS1
- Profile Attributes: DS1 (selected), P-SPAN
- DS1 Configuration Attributes:
 - Line Encoding: B8ZS
 - Line Buildout: 0.0 dB
 - Loopback: NONE
- Near-End 15-min Thresholds:
 - Errored Seconds - ES (0..900): 0
 - Severely Errored Seconds - SES (0..900): 0
 - Unavailable Seconds - UAS (0..900): 0
 - Coding Violations - CV (0..32767): 0
- Copy values from profile: (dropdown menu)
- Buttons: Create, Cancel, Help

FIGURE 6-184 Creating a DS1 Profile (DS1 tab)

FIGURE 6-185 Creating a DS1 Profile (PSPAN tab)

Note: If the user has already defined PSPAN Configuration Attributes and Counter Thresholds at the iMAP, the default for these in the Profile is set to False (read only), so they will not be affected. Otherwise, the user could define them here.

6.16.5 Provision the Two DS1 Ports

Selecting from the main menu *Tools -> Customer Management -> Add DS1 Customer* brings up the **Provision New DS1 Port** Form. This is the form where the main tasks for Provisioning the CES8 endpoint and the PSPAN are done. The device/ports available are the discovered DS1 ports in the managed network that are available for provisioning. Following are important points when filling out this form:

- You must input a Customer ID. When provisioning two endpoints, this ID will be applied to both endpoints in the Port Inventory table. This allows immediate recognition of which ports are included in the dual configuration. The name should be descriptive so that the user can identify the customer that owns the DS1 circuit.
- When you enter a peer port device, the Peer IP Address of the first endpoint is automatically filled in and is uneditable. (If only one port is being provisioned, leave the Peer Port Configuration panel empty. The Peer IP address in the PSPAN Configuration panel will then be editable.)
- The Port Profiles used for each endpoint do not have to match, but their PSPAN tab parameters must be compatible.
- When a DS1 port is successfully provisioned, there is an option to provision another port, in which case the Customer ID field is cleared, and the just provisioned ports are no longer available in the Port pull-down.

The screenshot shows the 'Provision New CES-DS1 Port' dialog box with the following configuration:

- Description (Customer ID):** ds1_dual
- Port Configuration:**
 - Device: 10.52.30.36
 - Slot.Port: 16.5
 - Port Profile: ds1_profile
 - Timing Reference: SELF
- PSPAN Configuration:**
 - IP Interface: vlan:1.1 / 10.10.36.16
 - RTP: OFF
 - UDP Port (49152..65535): 50005
 - Peer IP Address: 10.10.36.12
 - Peer UDP Port (49152..65535): 50004
- Peer Port Configuration (optional):**
 - Device: 10.52.30.36
 - Slot.Port: 12.4
 - Port Profile: ds1_profile
 - Timing Reference: SELF
- Schedule:**
 - Now (selected), Hold, Schedule: Nov 28, 2007, 3, 49, PM

Buttons at the bottom: Provision, Recent Commands..., Close, Help.

FIGURE 6-186 Provision a New DS1 Port (Dual Points)

The screenshot shows the 'Provision New CES-DS1 Port' dialog box with the same configuration as Figure 6-186. A 'Provisioning Successful!' dialog box is overlaid on top, asking: 'Do you wish to provision another new subscriber?' with 'Yes' and 'No' buttons.

FIGURE 6-187 Result of Success (Fields Ready for next Customer)

6.16.6 View Provisioning Results

To see the results of the dual endpoint provisioning, go to the Port Management window for the device and sort on Customer ID. Refer to the following figure.

Port Management

Device Name: 10.52.30.35

Ports

Port	Type	Description	Status
1.0	Ether-like (Gigabit Ethernet)	Ring1_0	Up
1.1	Ether-like (Gigabit Ethernet)	Ring1_1	Up
1.2	Ether-like-DS3 (Gigabit Ethernet)	DS3	Down
5.0	Ether-like (Optical Fast Ethernet)	IMG646MOD50	Up
5.1	Ether-like (Optical Fast Ethernet)	646mod	Up
5.2	Ether-like (Optical Fast Ethernet)	646bdon	Up
5.3	Ether-like (Optical Fast Ethernet)	RG656BD	Up
5.4	Ether-like (Optical Fast Ethernet)	RG613LH	Up
5.5	Ether-like (Optical Fast Ethernet)	IMG646BD	Up
5.6	Ether-like (Optical Fast Ethernet)	IMG613RF	Up
5.7	Ether-like (Optical Fast Ethernet)	606	Up
5.8	Ether-like (Optical Fast Ethernet)		Down
5.9	Ether-like (Optical Fast Ethernet)	IMG626MOD	Up
5.10	Ether-like (Optical Fast Ethernet)		Down
5.11	Ether-like (Optical Fast Ethernet)	IMG616WV	Up
5.12	Ether-like (Optical Fast Ethernet)		Down
5.13	Ether-like (Optical Fast Ethernet)	TESTING	Down
5.14	Ether-like (Optical Fast Ethernet)	A,A,A	Down
5.15	Ether-like (Optical Fast Ethernet)	tim222	Down
5.16	Ether-like (Optical Fast Ethernet)	pftTestFX20	Down
5.17	Ether-like (Optical Fast Ethernet)		Down
5.18	Ether-like (Optical Fast Ethernet)	tim646	Down
5.19	Ether-like (Optical Fast Ethernet)		Down
6.0	Ether-like (Gigabit Ethernet)		Down
6.1	Ether-like (Gigabit Ethernet)		Down

Provision Port... De-provision Port View/Modify Details... Cut-Over Port

Recent Commands... Close Help

Tue Aug 31 16:40:45 EDT 2010 - Polling of 10.52.30.35 successful.

FIGURE 6-188 Viewing Dual Endpoints - Same Customer ID

This shows that ports 12.4 and 16.5 are the endpoints. By double-clicking on either of these rows, the DS1 Port Management tabbed form appears, and one can view/modify the details of the configuration.

Note: In this tabbed form, it is possible to change the attributes of the endpoints, and even to split the dual endpoints into two single endpoints, if that is desired. However, in most cases the user should plan the dual endpoints so that configuration is easy and less prone to error.

6.16.6.1 DS1 Port Tab

The following figure shows the form that appears when the user double-clicks on port 16.5.

The port 16.5 is on the left, since that is the row that was selected; if the user selected 12.4, port 12.4 would appear on the left.

The user can change attributes that are part of the Profile, but after clicking on Modify the user would see the Profile with an “*” next to it, meaning the Profile is out-of-sync. (This would also show up in the port inventory table.) The user would need to re-apply the profile to make the “*” disappear.

Note: The DS1 tab shows only the implicit connection between the endpoints; it is the PSPAN tab that explicitly ties the two endpoints together, discussed below.

The screenshot shows a window titled "CES-DS1 Port Management" with a tabbed interface. The active tab is "CES-DS1 Port". The window displays configuration for two ports: 16.5 (left) and 12.4 (right). Both ports are on device 10.52.30.36. The configuration for both ports is identical:

Attribute	Port 16.5	Port 12.4
Admin. State/Status	Up	Up
Oper. State/Link State	Down	Down
Status	Dependency	Dependency
Type	CES-DS1	CES-DS1
Description (Customer ID)	ds1_dual	ds1_dual
Timing Reference	SELF	SELF
Profile	ds1_profile	ds1_profile
Line Encoding	B8ZS	B8ZS
Line Build Out	0.0DB	0.0DB
Framing	Unframed	Unframed
Direction	Customer	Customer
Loopback Status	OFF	OFF
Loopback Type	Unknown	Unknown
Loopback Location	Unknown	Unknown
Runtime Attribute		
Received AIS	Unknown	Unknown
Port Alarms	N/A	N/A

At the bottom of the window, there are buttons for "Modify", "Disable", "Enable", "Alarms...", and "Clear Entry Fields". Below these buttons are "Recent Commands...", "Close", and "Help" buttons. A status bar at the very bottom shows two log entries: "Wed Nov 28 15:51:14 EST 2007 - Polling of 10.52.30.36 successful."

FIGURE 6-189 Viewing Dual CES points - DS1 Port Tab

6.16.6.2 PSPAN Tab

The following figure shows the PSPAN tab for the two endpoints.

As with the DS1 tab, the row selected is the port that appears on the left.

The main attributes of the PSPANs are at the top of the form and are read only.

The editable attributes are at the bottom of the form. Note, however, that the Peer IP Address and Peer UDP Port are read only since this is a two-port configuration. (In a one-port configuration, these fields are editable.)

Changing the RTP for one PSPAN changes it for both PSPANs to keep them compatible.

Device: 10.52.30.36 Port: 16.5 Device: 10.52.30.36 Port: 12.4

CES-DS1 Port **PSPAN** PMON Statistics Stats Graph Port Thresholds Port Log

Device: 10.52.30.36 Port: 16.5 10.52.30.36 Port: 12.4

PSPAN ID: PSPAN:550.16.5 PSPAN:550.12.4

Admin. State/Status: UP UP

Oper. State/Link State: DOWN DOWN

Status: Dependency Dependency

Encapsulation: SAToP over IPv4 SAToP over IPv4

Timing Reference: CONNECTION CONNECTION

RTP: OFF OFF

IP Address: 10.10.36.16 10.10.36.12

Peer IP Address: 10.10.36.12 10.10.36.16

UDP Port (49152..65535): 50005 50004

Peer UDP Port (49152..65535): 50004 50005

Bytes per Packet (16..1023): 193 193

Jitter Buffer Size (Microsecs): 6000 6000

VLAN Priority (0..7): 6 6

IP DiffServ Code Point (0..63): 46 46

Runtime Attributes

Received Indications: False False

Transmitted Indications: False False

PSPAN Alarms: N/A N/A

Jitter Buffer (Microsecs): 0 0

Jitter Max / Avg / Min: 0 / 0 / 0 0 / 0 / 0

Modify Disable Enable Alarms... Clear Entry Fields

Recent Commands... Close Help

Wed Nov 28 15:52:39 EST 2007 - Polling of 10.52.30.36 successful.
Wed Nov 28 15:52:39 EST 2007 - Polling of 10.52.30.36 successful.

FIGURE 6-190 Viewing Dual CES points - PSPAN Tab

6.16.6.3 PMON Statistics Tab

This tab shows the PMON Statistics tab. Refer to the following figure.

Note that the table lists the 16.5 and 12.4 Port and PSPAN statistics together.

When the user presses the function buttons (Enable, Disable, etc.), they are applied to **both** ports.

Port Statistics

Name	Current 15 Min.	Current Day	Current 15 Min.	Current Day
SES (Severely Errored Seconds)	0	0	0	0
UAS (Unavailable Seconds)	0	0	0	0
LES (Line Errored Seconds)	0	0	0	0
LCV (Line Code Violations)	0	0	0	0
LOSS (Loss of Signal Seconds)	0	0	0	0

PSPAN Statistics

Name	Current 15 Min.	Current Day	Current 15 Min.	Current Day
ES (Severely Error Seconds)	0	0	0	0
LOPS (Loss of Packet Sequence)	0	0	0	0
Late Packets	0	0	0	0
Early Packets	0	0	0	0
Lost Packets	0	0	0	0
Maximum Jitter	0	N/A	0	N/A
Average Jitter	0	N/A	0	N/A
Minimum Jitter	0	N/A	0	N/A
Packets Received	N/A	0	N/A	0
Bytes Received	N/A	0	N/A	0
Packets Sent	N/A	0	N/A	0
Bytes Sent	N/A	0	N/A	0

Valid Intervals: 0 0
 Invalid Intervals: 0 0

Buttons: Enable Statistics, Disable Statistics, Reset PMON Statistics

Buttons: Recent Commands..., Close, Help

Wed Nov 28 15:53:13 EST 2007 - Polling of 10.52.30.36 successful.
 Wed Nov 28 15:53:13 EST 2007 - Polling of 10.52.30.36 successful.

FIGURE 6-191 PMON Statistics Tab for two Endpoints

6.16.6.4 Stats Graph Tab

This form makes graphs of the statistics and allows the stats used to be saved as a list and reloaded later. Refer to the following figure.

Note: The statistics for each endpoint have the suffix **-A** or **-Z** to identify each one. The **-A** is the port on the left side of the two ports shown at the top of the form, and the **-Z** is the right side.

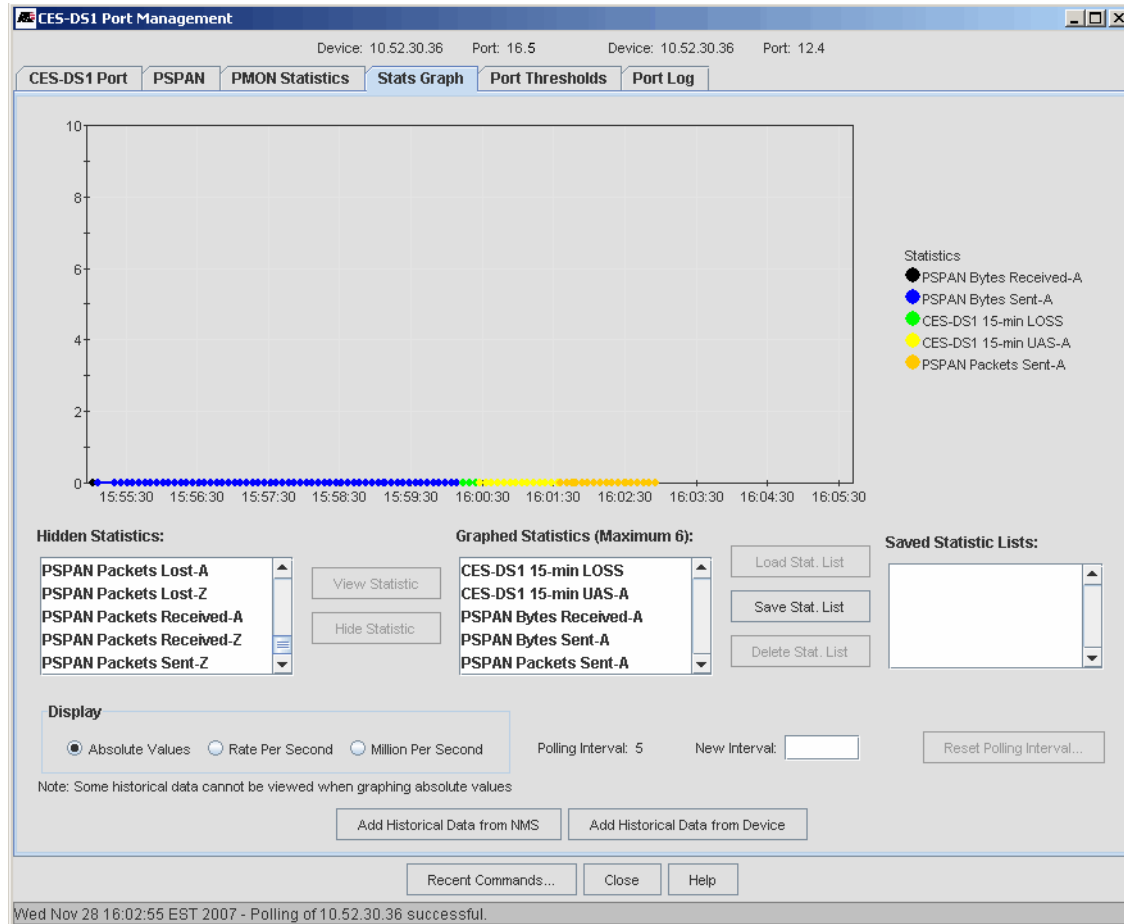

FIGURE 6-192 Stats Graph Tab for two Endpoints

6.16.6.5 Port Thresholds Tab

This form allows the user to modify the threshold values for the DS1/E1 and PSPAN statistics. When a new value is entered in the New Value field, the Modify button is enabled.

Note: In most cases, the DS1/E1 values are not modified because they are part of the DS1/E1 port profile; if the user does change a value, the port is now out of sync with its associated profile, and an "" will appear next to the Profile name on the DS1/E1 Port tab form (as well as the Port Inventory table). In the dual endpoint configuration, the "*" will appear next to the specific port where the values were changed from the Profile. To Resync the port, the user must re-apply the profile on the DS1/E1 tab form, which puts the values back to what they are in the Profile.*

The screenshot displays the 'CES-DS1 Port Management' window with the 'Port Thresholds' tab selected. It shows configuration for two endpoints: Device: 10.52.30.36 Port: 16.5 and Device: 10.52.30.36 Port: 12.4. The interface is divided into two main sections: 'CES-DS1 Thresholds' and 'P-SPAN Thresholds'. Each section contains a table of metrics with 'Current Value' and 'New Value' input fields. The 'CES-DS1 Thresholds' section includes metrics for 15 Min ESs, 15 Min SESs, 15 Min UASs, and 15 Min CVs. The 'P-SPAN Thresholds' section includes metrics for 15 Min LOPSS, 15 Min LATE PKTS, 15 Min EARLY PKTS, and 15 Min LOST PKTS. At the bottom of the window, there are buttons for 'Modify', 'Clear Entry Fields', 'Recent Commands...', 'Close', and 'Help'. A status bar at the very bottom shows two lines of text: 'Wed Nov 28 16:03:31 EST 2007 - Polling of 10.52.30.36 successful.'

FIGURE 6-193 Port Thresholds Graph Tab for two Endpoints

6.16.6.6 Port Log Tag

The following figure shows the Port Log tab for the two endpoints. Note that since these cards are on the same device; there is no need for a device column, and the Device name repeated twice on the top of the form. (If the two endpoints were on different devices, a Device column would be added, and the user could sort by Device.)

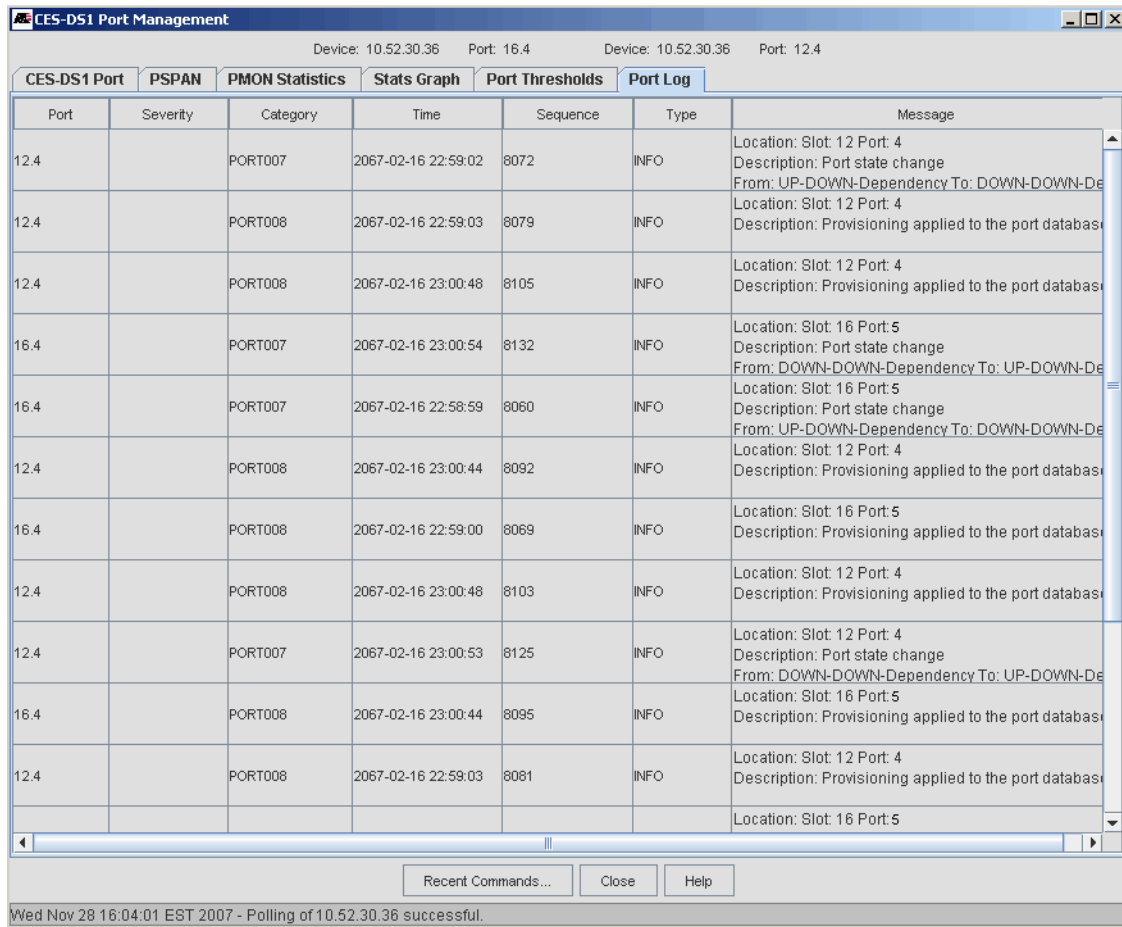

Port	Severity	Category	Time	Sequence	Type	Message
12.4		PORT007	2067-02-16 22:59:02	8072	INFO	Location: Slot: 12 Port: 4 Description: Port state change From: UP-DOWN-Dependency To: DOWN-DOWN-De
12.4		PORT008	2067-02-16 22:59:03	8079	INFO	Location: Slot: 12 Port: 4 Description: Provisioning applied to the port databas
12.4		PORT008	2067-02-16 23:00:48	8105	INFO	Location: Slot: 12 Port: 4 Description: Provisioning applied to the port databas
16.4		PORT007	2067-02-16 23:00:54	8132	INFO	Location: Slot: 16 Port: 5 Description: Port state change From: DOWN-DOWN-Dependency To: UP-DOWN-De
16.4		PORT007	2067-02-16 22:58:59	8060	INFO	Location: Slot: 16 Port: 5 Description: Port state change From: UP-DOWN-Dependency To: DOWN-DOWN-De
12.4		PORT008	2067-02-16 23:00:44	8092	INFO	Location: Slot: 12 Port: 4 Description: Provisioning applied to the port databas
16.4		PORT008	2067-02-16 22:59:00	8069	INFO	Location: Slot: 16 Port: 5 Description: Provisioning applied to the port databas
12.4		PORT008	2067-02-16 23:00:48	8103	INFO	Location: Slot: 12 Port: 4 Description: Provisioning applied to the port databas
12.4		PORT007	2067-02-16 23:00:53	8125	INFO	Location: Slot: 12 Port: 4 Description: Port state change From: DOWN-DOWN-Dependency To: UP-DOWN-De
16.4		PORT008	2067-02-16 23:00:44	8095	INFO	Location: Slot: 16 Port: 5 Description: Provisioning applied to the port databas
12.4		PORT008	2067-02-16 22:59:03	8081	INFO	Location: Slot: 12 Port: 4 Description: Provisioning applied to the port databas
						Location: Slot: 16 Port: 5

FIGURE 6-194 Port Log Tab for two Endpoints

6.16.7 Provisioning iMG6x6MOD with T1/E1 Card and CES

In release 10.0, it is possible to configure an iMG6x6MOD with a T1/E1 card. This card has two ports, where **both** are configured as either DS1 or E1 signal formats (for the two T1 or E1 ports respectively). The DS1 configuration (T1) is shown below.

At the other end of the DS1 connection, a CES8 port can be configured. Provisioning this iMG-CES8 port connection is similar to the CES8-CES8 port connection as shown in 6.16.5, since the parameters datafilled on the iMG6x6MOD are similar to those for the CES8. However, there are some key differences in the use of profiles and the Triple-Play provisioning, in that all services, not just CES, are provisioned together on the iMG, while only the individual CES port is provisioned on the iMAP CES8 card.

First, refer to Figure 6-195, which shows how each DS1 port on the iMG can be connected with separate ports on the CES8 card. Included are the parameters that need to be datafilled at each endpoint.

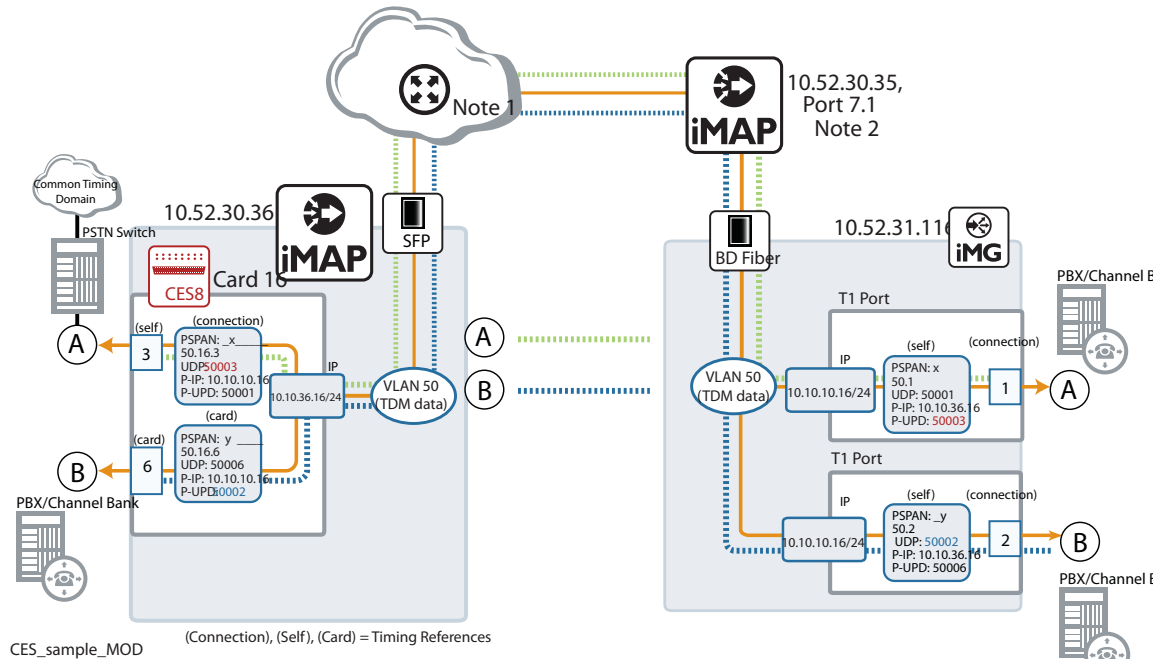

Note 1: Router is needed since DS1 LANs are on different subnets (10.10.36.0/24 and 10.10.10.0/24)

Note 2: Other iMAPs in network would provide topology (EPSR) for VLAN (In this case, 10.52.30.35 connects over port 7.1 to iMG6x6MOD)

FIGURE 6-195 CES8 to iMG6x6MOD Connections

Provisioning this involves the following steps.

Note: This example assumes a DS1 connection. An E1 example would be similar.

6.16.7.1 Create RG_CES_DS1 Profiles

This has similar attributes to the iMAP CES DS1 profile, except that this will be for a DS1 port on the iMG6x6MOD. Select **Network Services -> Profile -> iMG/RG Service Profiles -> Create iMG/RG CES-DS1 Port Profile**. Refer to the following figures which show two profiles; each profile could be applied to a different DS1 port on the CES card on the iMG6x6MOD. Key attributes are:

- A Timing Reference parameter is included with values { Self | Connection | Internal } on the DS1/E1 Tab. It's value should be compatible with the Peer end. (Note that there is no CARD value for the RG.)
- Line Encoding

The screenshot shows a 'Create Profile' window with the following details:

- Profile Name: iMG6x6_ds1_0dB
- Profile Type: RG-CES-DS1
- Profile Attributes: DS1 (selected), P-SPAN
- DS1 Configuration Attributes:
 - Attribute New Value
 - Line Encoding: B8ZS
 - Line Buildout: 0.0 dB
 - Loopback: NONE
 - Timing Reference: CONNECTION
- Copy values from profile: [dropdown]
- Buttons: Create, Cancel, Help

FIGURE 6-196 Creating a RG-CES-DS1 Profile - DS1 (0dB)

The screenshot shows the 'Create Profile' dialog box with the following details:

- Profile Name:** iMG6x6_ds1_15dB
- Profile Type:** RG-CES-DS1
- Profile Attributes:** DS1 (selected), P-SPAN
- DS1 Configuration Attributes:**
 - Attribute New Value
 - Line Encoding: B8ZS
 - Line Buildout: -15.0 dB
 - Loopback: NONE
 - Timing Reference: CONNECTION
- Copy values from profile:** iMG6x6_ds1_0dB
- Buttons:** Create, Cancel, Help

FIGURE 6-197 Creating a RG-CES-DS1 Profile - DS1 (15 dB)

The following figure shows the PSPAN tab attributes that are datafilled as part of the RG-CES DS profile. The key attributes RTP and Bytes per Packet should match the Peer end.

The screenshot shows the 'Create Profile' dialog box with the following details:

- Profile Name:** iMG6x6_ds1_0dB
- Profile Type:** RG-CES-DS1
- Profile Attributes:** DS1, P-SPAN (selected)
- PSPAN Configuration Attributes:**
 - New Value
 - Use RTP: True
 - Bytes per Packet (16..1023): 193
 - Jitter Buffer Size (Microsecs): 6000
 - IP DiffServ Code Point (0..63): 46
- Copy values from profile:** iMG6x6_ds1_0dB
- Buttons:** Create, Cancel, Help

FIGURE 6-198 Creating a RG-CES-DS1 Profile - PSPAN

6.16.7.2 Create an iMG/RG CES Service Profile

Select *Network Services -> Profile -> Create iMG CES- Service Profile*. Refer to the following figures.

Key attributes are:

- Ports Type: {DS1/E1}
- CES VLAN ID - This is used if the Open Access model is being used. See 6.16.7.3.
- Port 1 RG-CES Port Profile
- Port 2 RG-CES Port Profile

The CES VLAN ID can be specified here to support common CES VLANs across customers. The RG-CES Port Profiles will also be used in the Port Management screens when RG port details are displayed.

The screenshot shows a 'Create Profile' dialog box with the following fields and values:

- Profile Name: iMG6x6_vlan50
- Profile Type: RG CES
- Attribute New Value: Include CES VLAN in Profile: True
- iMG/RG CES VC/VLAN Id (2..4094): 50
- Ports Type: DS1
- CES VLAN Priority (0..7): 6
- Port 1 CES Profile: iMG6x6_ds1_0dB
- Port 2 CES Profile: iMG6x6_ds1_15dB

At the bottom, there is a 'Copy values from profile:' dropdown menu, a 'Copy' button, and three buttons: 'Create', 'Cancel', and 'Help'.

FIGURE 6-199 iMG CES Service Profile

6.16.7.3 Create an iMG/RG General Profile

Create an iMG/RG General Profile. This has attributes for provisioning other services on the iMG6x6MOD as well as other iMG/RG types. Note that there is a CES VLAN Id field. If the Access Island model is being used, set the Include Service VLAN in Profile to True, and the VLANs are editable. For Open Access, set this to False, so that VLANs are filled in for the iMG/RG Profiles for each service type. (In this example, it would be set to False, since for the RG CES Profile the Include option was set to True with a VLAN ID of 50. Refer to the following figure.

Profile Name: Profile Type: RG General

Profile Attributes

Mgmt. Info | Wireless | Port Assignment | IP Routes

Attribute New Value

Profile Scoping:

IMG/RG Bootstrap VLAN Id (1..4094 or None):

IMG/RG Mgmt VC/VLAN Id (2..4094):

Include Service VLANs in Profile:

IMG/RG Internet VC/VLAN Id (2..4094 or None):

IMG/RG Video VC/VLAN Id (2..4094 or None):

IMG/RG Voice VC/VLAN Id (2..4094 or None):

IMG/RG CES VC/VLAN Id (2..4094 or None):

Attribute New Value

Loop Detection:

SNMP Server (IP Addr. or None):

Daylight Saving:

Time Zone:

Limited User Login (login or None):

New Limited User Password:

New Manager Password:

Super User Login (login or None):

New Super User Password:

Split Management:

Subscriber User Login: admin

New Subscriber User Password: admin

Mgmt. Subnets

Name	Subnet Addr.	Mask	Start Addr.	End Addr.

Copy values from profile:

FIGURE 6-200 iMG/RG General Profile - includes CES DS1 VLAN

6.16.7.4 Provision the Triple-Play Form

As mentioned in 7.2.4, there are different strategies to provisioning the iMG/RG. In this example, the iMG646MOD is already known to the iMAP, and now the Triple Play Form will be filled out and then applied. Refer to the following figure.

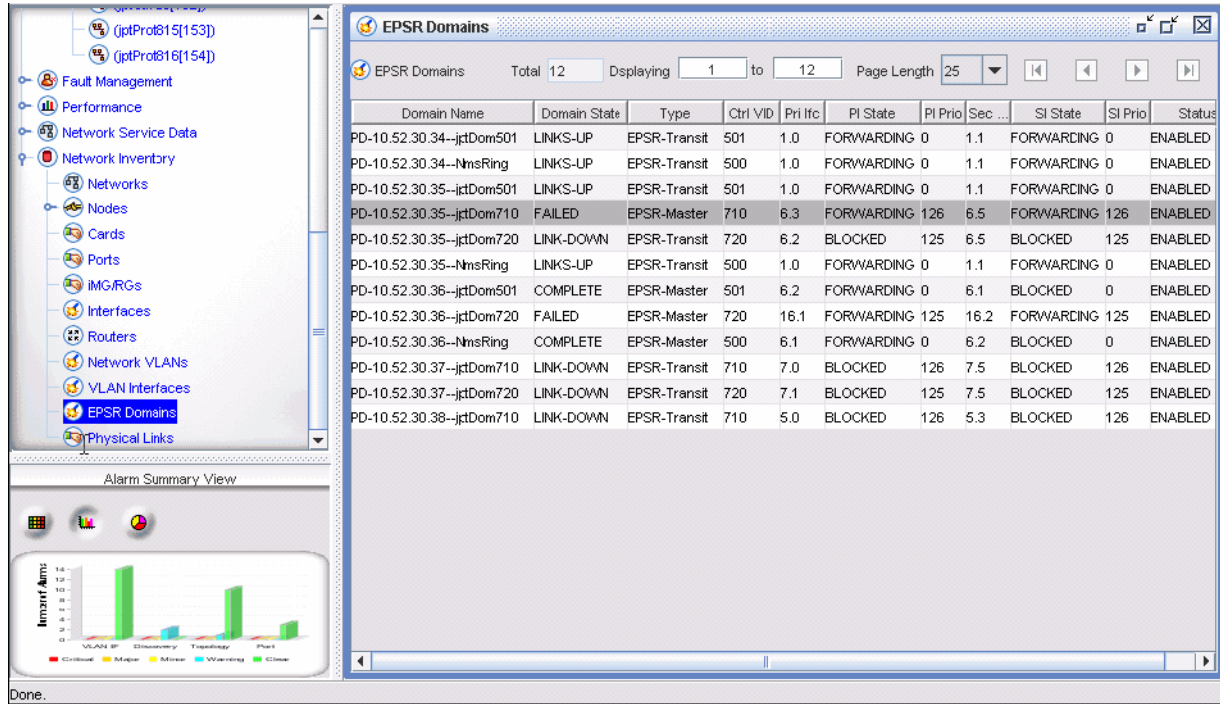

FIGURE 6-201 Provisioning the iMG646MOD for Triple Play Service

In the Triple Play form that comes up, this screen will allow the user to select an iMG/RG General Profile in which a new CES Service Configuration section will appear. Refer to the following figure.

FIGURE 6-202 Triple Play Form - Selecting General Profile brings up CES Service Config

Selection of the CES Service Profile permits entry of the following parameters.

- CES Service Profile (an RG CES Service Profile - for required module and port attributes)
- Local CES IP and mask (for the CES module being provisioned - Module specific)
- CES Port 1: will need LocalUDP, PeerIP, and PeerUDP (customer specific)
- CES Port 2: will need LocalUDP, PeerIP, and PeerUDP (customer specific)

The Provision Button becomes active after specifying the required parameters and the CustomerID (at the top).

The provision tasks are run when the Provision Button is pressed. Refer to the following figure. When finished, the user has the option of Provisioning a new subscriber.

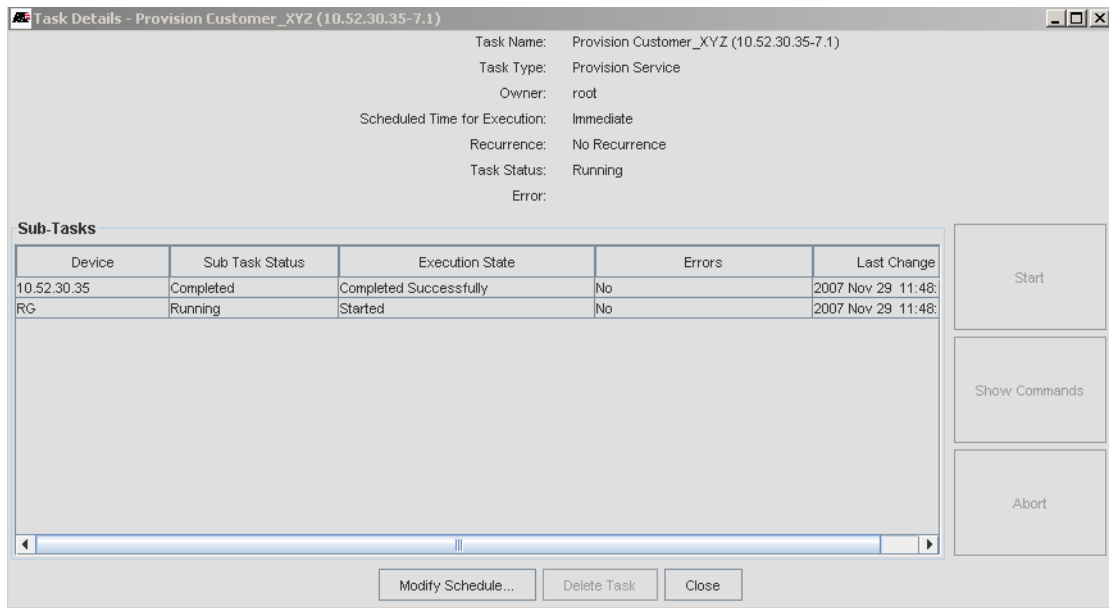

FIGURE 6-203 Task Panel as iMG646MOD/T1Completes

6.16.7.5 Viewing Results

Once the iMG646MOD is provisioned, the user can view the details by going to the RG table and selecting View/Modify Details from the pull-down, as shown in the following figures.

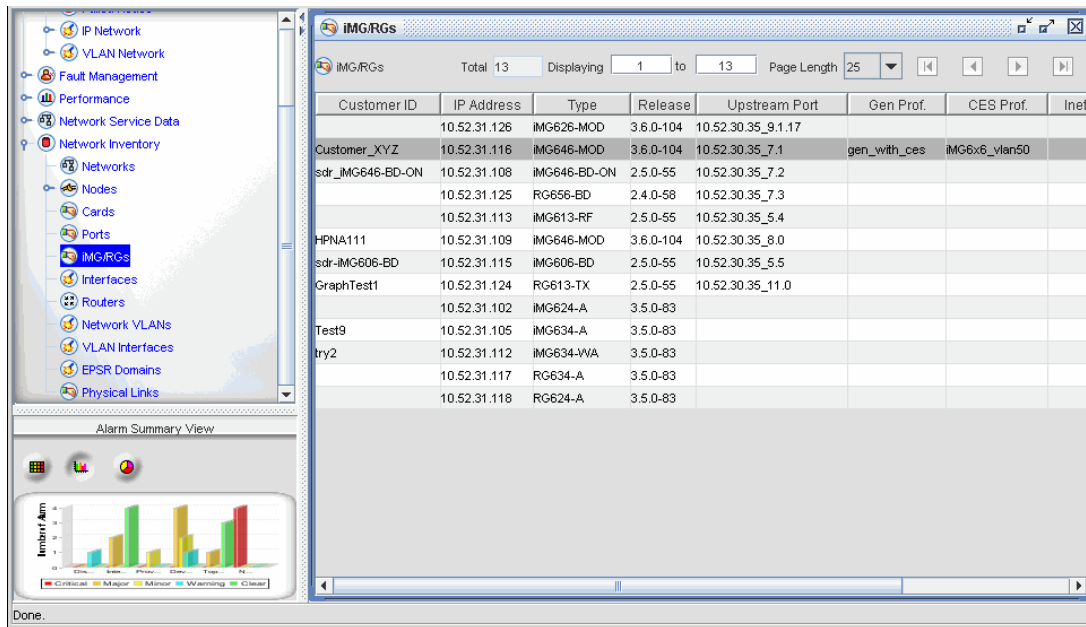

FIGURE 6-204 iMG/RG Inventory Table with Provisioned iMG646MOD and CES Service

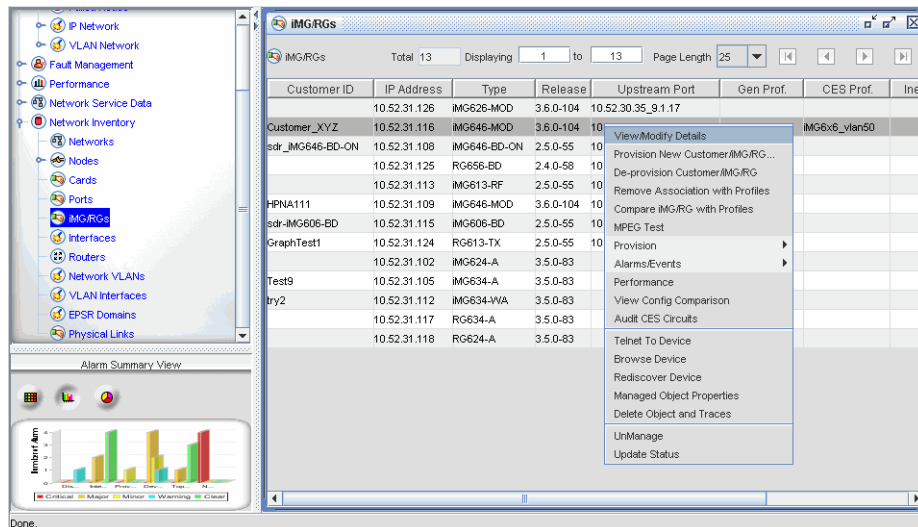

FIGURE 6-205 Right Clicking on the iMG646MOD and View/Modify Details

The *IMG/RG* -> *Mgmt Info* tab now shows the CES VLAN, similar to the other services.

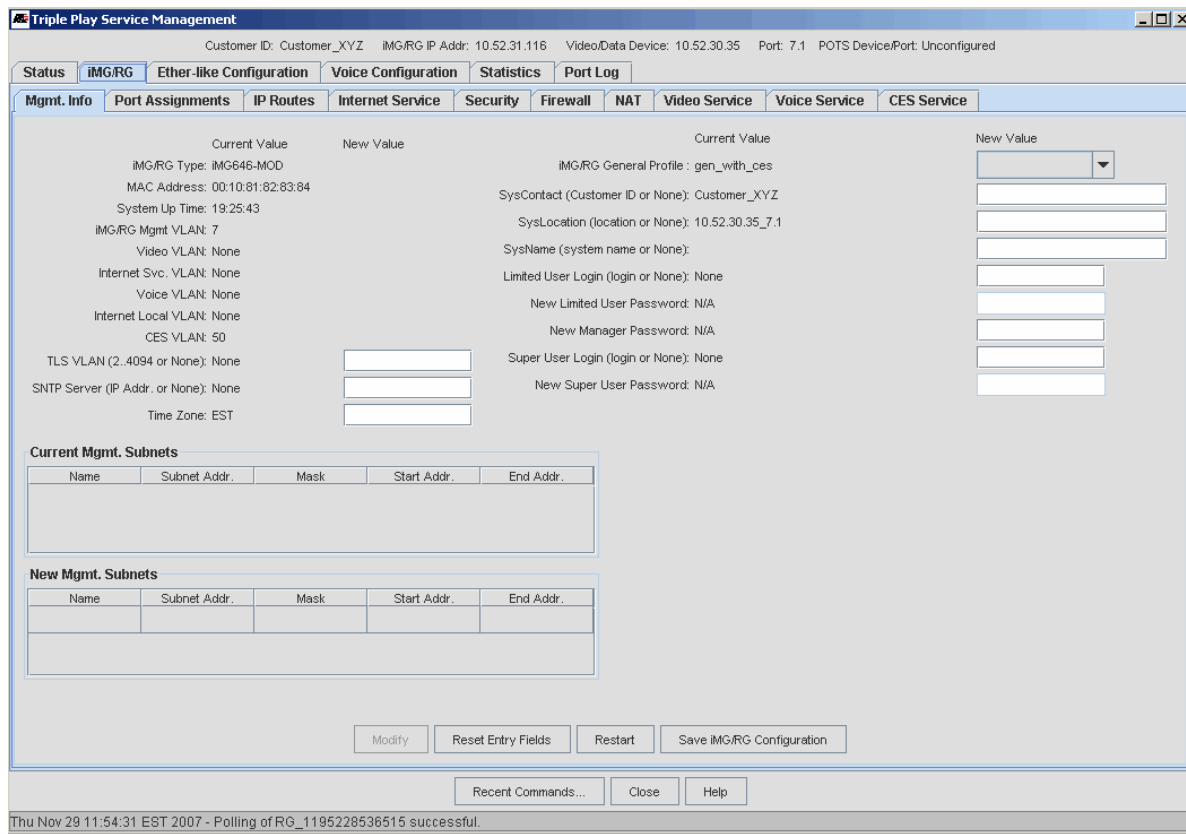

FIGURE 6-206 iMG/RG -> Mgmt Info tab

The CES Service Tab provides the specific CES parameters and allows the user to view/change the DS1 ports. Refer to the following figure

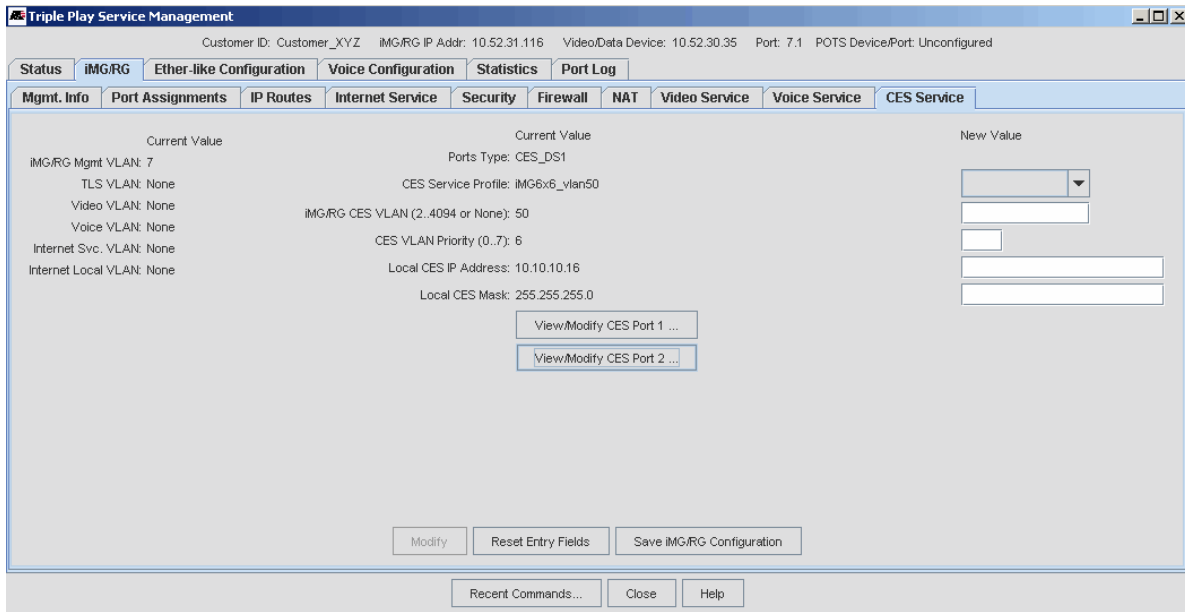

FIGURE 6-207 View the CES Service Parameters

Selecting the View/Modify CES Port buttons brings up the CES DS1/E1 Port Management Panel, with a different panel for each port, 1 and 2. These tabs allow the user to view and change the parameters if necessary. Refer to the following figures.

Caution: *Changing these parameters must be done with care, since there may be complementary parameters at the other end of the connection, and so a change in a parameter value may affect service.*

CES-DS1 Port Management

Device: Customer_XYZ Port: 2 Device: 10.52.30.36 Port: 16.6

CES-DS1 Port | PSPAN | PMON Statistics | Stats Graph | Port Thresholds | Port Log

Device: Customer_XYZ Port: 2 10.52.30.36 Port: 16.6

Admin. State/Status: Up Up
Oper. State/Link State: Down Down
Status: Dependency
Type: CES-DS1 CES-DS1

Description (Customer ID): Customer_XYZ [] Customer_XYZ []

Timing Reference: CONNECTION [] SELF []

Profile: iMG6x6_ds1_15dB [] ds1_profile []

Line Encoding: B8ZS [] B8ZS []

Line Build Out: -15.0DB [] 0.0DB []

Framing: Unframed Unframed
Direction: Customer Customer

Loopback Status: N/A OFF
Loopback Type: NONE [] Unknown []

Loopback Location: Near End Unknown

Runtime Attribute
Received AIS: false Unknown
Port Alarms: LOS N/A

Modify Disable Enable Alarms... Clear Entry Fields

Recent Commands... Close Help

Thu Nov 29 12:25:20 EST 2007 - Polling of RG_1195228536515 successful.
Thu Nov 29 12:25:20 EST 2007 - Polling of 10.52.30.36 successful.

FIGURE 6-208 CES-DS1 Port Parameter Form - Port 2 on the iMG6x6MOD

Device: Customer_XYZ Port: 2 Device: 10.52.30.36 Port: 16.6

CES-DS1 Port **PSPAN** PMON Statistics Stats Graph Port Thresholds Port Log

Device: Customer_XYZ Port: 2 10.52.30.36 Port: 16.6

PSPAN ID: pspan-2 PSPAN: 50.16.6

Admin. State/Status: Up UP

Oper. State/Link State: Down DOWN

Status: Dependency

Encapsulation: SAToP over IPv4 SAToP over IPv4

Timing Reference: SELF CONNECTION

RTP: ON ON

IP Address: 10.10.10.16 10.10.36.16

Peer IP Address: 10.10.36.16 10.10.10.16

UDP Port (49152..65535): 50002 50006

Peer UDP Port (49152..65535): 50006 50002

Bytes per Packet (16..1023): 193 193

Jitter Buffer Size (Microsecs): 6000 6000

VLAN Priority (0..7): 6 6

IP DiffServ Code Point (0..63): 46 46

Runtime Attributes

Received Indications: <NONE> False

Transmitted Indications: Local Loss of Carrier False

PSPAN Alarms: COMM N/A

Jitter Buffer (Microsecs): 0 0

Jitter Max / Avg / Min: Unavailable 0 / 0 / 0

Modify Disable Enable Alarms... Clear Entry Fields

Recent Commands... Close Help

Thu Nov 29 12:26:39 EST 2007 - Polling of RG_1195228536515 successful.
Thu Nov 29 12:26:39 EST 2007 - Polling of 10.52.30.36 successful.

FIGURE 6-209 CES-DS1 PSPAN Parameter Form - Port 2 on the iMG6x6MOD

Device: Customer_XYZ Port: 2 Device: 10.52.30.36 Port: 16.6

Device: Customer_XYZ Port: 2 Device: 10.52.30.36 Port: 16.6

Name	Current 15 Min.	Current Day	Current 15 Min.	Current Day
SES (Severely Errored Seconds)	N/A	0	0	0
UAS (Unavailable Seconds)	N/A	71890	0	0
LES (Line Errored Seconds)	N/A	0	0	0
LCV (Line Code Violations)	N/A	0	0	0
LOSS (Loss of Signal Seconds)	N/A	71890	0	0

Device: RG_1195228536515 Port: 2 Device: 10.52.30.36 Port: 16.6

Name	Current 15 Min.	Current Day	Current 15 Min.	Current Day
ES (Severely Error Seconds)	N/A	0	0	0
LOPS (Loss of Packet Sequence)	N/A	0	0	0
Late Packets	N/A	0	0	0
Early Packets	N/A	0	0	0
Lost Packets	N/A	0	0	0
Maximum Jitter	0	N/A	0	N/A
Average Jitter	0	N/A	0	N/A
Minimum Jitter	0	N/A	0	N/A
Packets Received	N/A	0	N/A	0
Bytes Received	N/A	N/A	N/A	0
Packets Sent	N/A	0	N/A	0
Bytes Sent	N/A	N/A	N/A	0

Valid Intervals: 0
Invalid Intervals: 0

Enable Statistics Disable Statistics Reset PMON Statistics

Recent Commands... Close Help

Thu Nov 29 12:27:17 EST 2007 - Polling of RG_1195228536515 successful.
Thu Nov 29 12:27:16 EST 2007 - Polling of 10.52.30.36 successful.

FIGURE 6-210 CES-DS1 PMON Statistics Parameter Form - Port 2 on the iMG6x6MOD

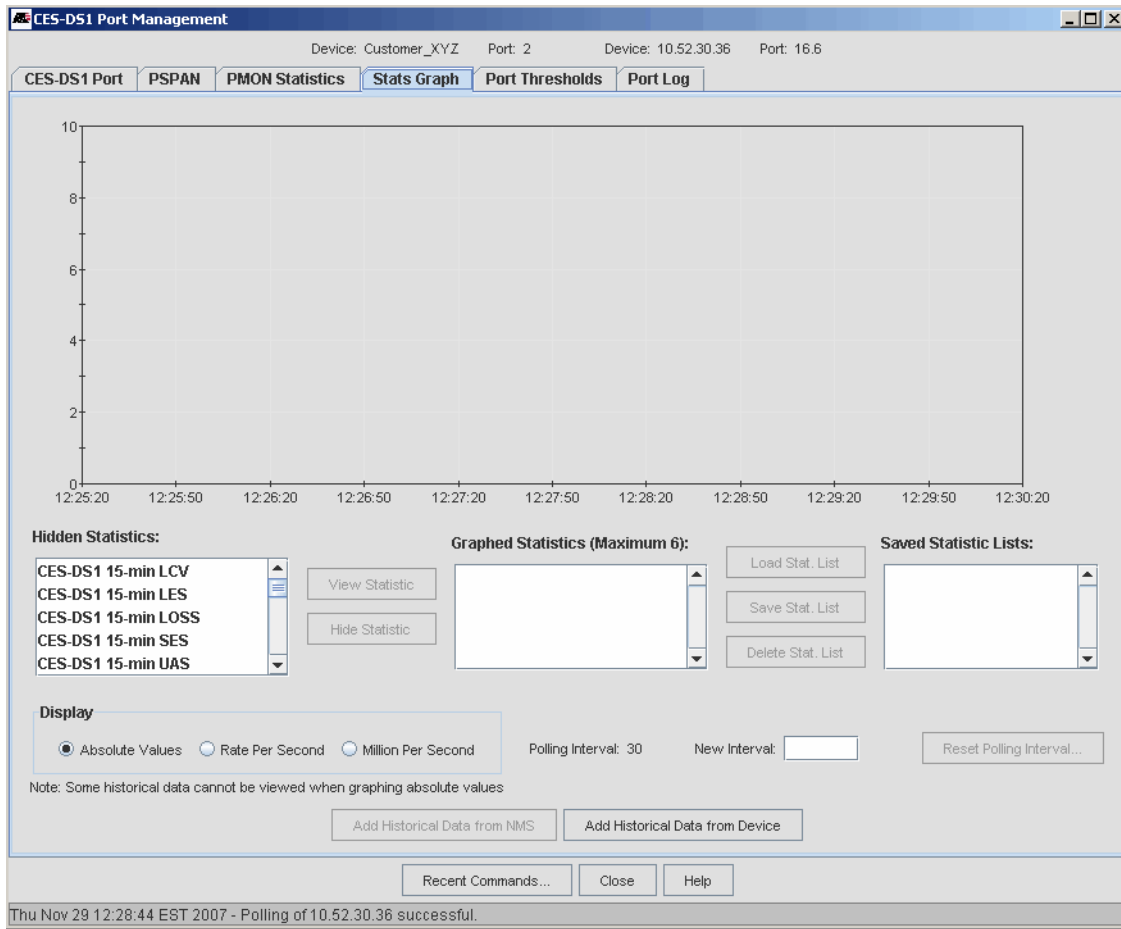

FIGURE 6-211 CES-DS1 Graph Statistics Parameter Form - Port 2 on the iMG6x6MOD

Note: Only the CES8 Stats are currently available in graph format. Use the PMON Statistics tab for iMG statistics.

Device: Customer_XYZ Port: 2 Device: 10.52.30.36 Port: 16.6

CES-DS1 Port PSPAN PMON Statistics Stats Graph **Port Thresholds** Port Log

CES-DS1 Thresholds

	Current Value	New Value
15 Min ESs (0..900):	0	<input type="text"/>
15 Min SESs (0..900):	0	<input type="text"/>
15 Min UASs (0..900):	0	<input type="text"/>
15 Min CVs (0..32767):	0	<input type="text"/>

P-SPAN Thresholds

	Current Value	New Value
15 Min ESs (0..900):	0	<input type="text"/>
15 Min LOPSS (0..900):	0	<input type="text"/>
15 Min LATE PKTS (0..4294967295):	0	<input type="text"/>
15 Min EARLY PKTS (0..4294967295):	0	<input type="text"/>
15 Min LOST PKTS (0..4294967295):	0	<input type="text"/>

Modify Clear Entry Fields

Recent Commands... Close Help

Thu Nov 29 12:29:27 EST 2007 - Polling of 10.52.30.36 successful.

FIGURE 6-212 CES-DS1 Port Thresholds Parameter Form - Port 2 on the iMG6x6MOD

Note: Only the CES8 thresholds appear. The iMG does not support thresholds that can be set.

CES-DS1 Port	PSPAN	PMON Statistics	Stats Graph	Port Thresholds	Port Log		
Device	Port	Severity	Category	Time	Sequence	Type	Message
10.52.30.36	16.6		PORT008	2067-02-17 19:36:28	8750	INFO	Location: Slot 16 Port: 6 Description: Provisioning applied to the
10.52.30.36	16.6		PORT008	2067-02-17 19:36:30	8756	INFO	Location: Slot 16 Port: 6 Description: Provisioning applied to the
10.52.30.36	16.6		PORT008	2067-02-17 19:36:27	8748	INFO	Location: Slot 16 Port: 6 Description: Provisioning applied to the
10.52.30.36	16.6		PORT007	2067-02-17 19:36:35	8769	INFO	Location: Slot 16 Port: 6 Description: Port state change From: DOWN-DOWN-Dependency To:
10.52.30.36	16.6		PORT007	2067-02-17 19:36:27	8743	INFO	Location: Slot 16 Port: 6 Description: Port state change From: UP-DOWN-Dependency To: DO
10.52.30.36	16.6		PORT008	2067-02-17 19:36:30	8758	INFO	Location: Slot 16 Port: 6 Description: Provisioning applied to the

Recent Commands... Close Help

Thu Nov 29 12:30:07 EST 2007 - Polling of 10.52.30.36 successful.

FIGURE 6-213 CES-DS1 Port Log Parameter Form - Port 2 on the iMG6x6MOD

Note: Only the CES8 port logs appear. The iMG port does not support the Port Log feature.

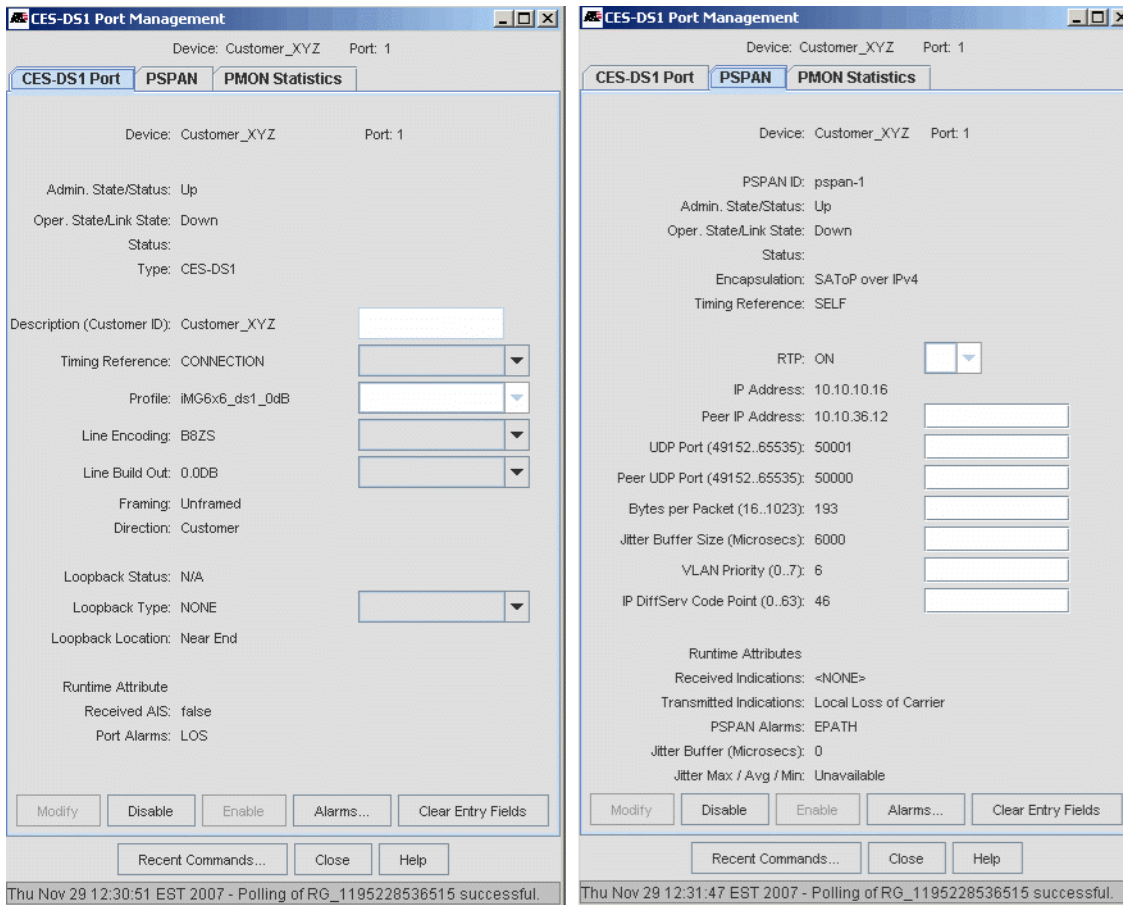

FIGURE 6-214 CES-DS1 Port and PSPAN Parameter Form - Port 1 on the iMG6x6MOD

Note: In the example configuration, the peer end of Port 1 is not managed by the NMS. In this case, the one-sided screens will appear with the iMG supported tabs only.

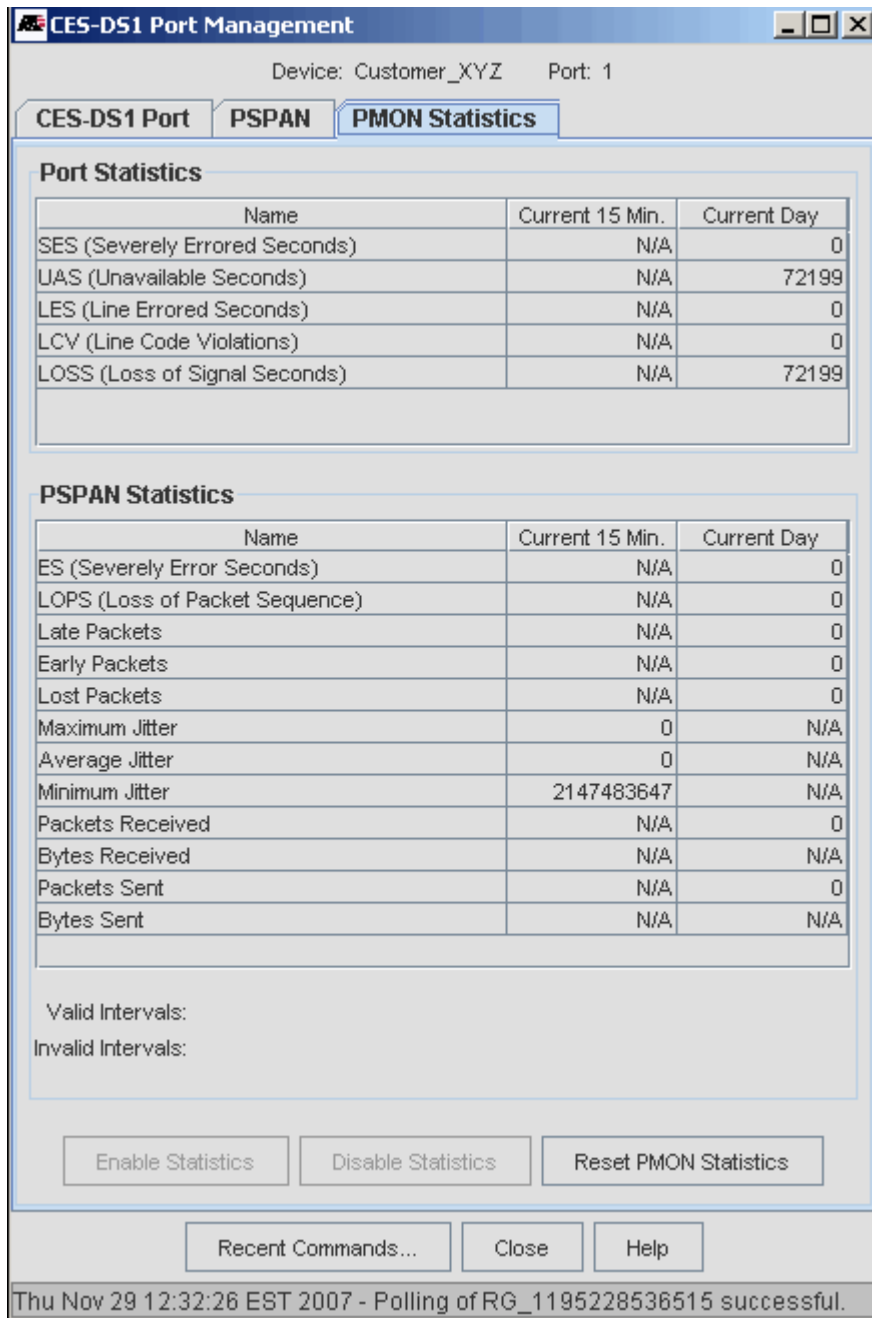

FIGURE 6-215 PMON Statistics Form - Port 1 on the iMG6x6MOD

6.17 NTE8 Dual Circuit Provisioning

In Release 7.0, the NTE8 card is used to allow DS1/E1 facilities to connect (backhaul) the ethernet network, with both ends of the DS1/E1 connections being on iMAP 9000 devices. Refer to the *iMAP User Guide* for a complete description of the NTE8 configuration.

Note: Refer to 5.5.15 and 5.6.21 for an overview of the NTE8 card and DS1/E1 port attributes.

The NTE8 configuration always has dual endpoints, since there must be an iMAP 9000 device at each end. Moreover, each end must be correctly provisioned for the logical hierarchy (DS1, PPP, MLPPP, ETH) of the NTE8. Finally, the hierarchy for each endpoint in a pair must be the same.

Configuring an MLPPP interface and its associated ETH interface is less straight-forward than the PPP interface, since the MLPPP can be associated with one or more ports. Since the MLPPP/PPP relationship has to be consistent at both ends of the DS1/E1 circuit, the user should configure both ends of the MLPPP (and its DS1/E1) connections at the same time.

The following figure shows an example configuration using DS1 ports. It includes a PPP-only as well as an MLPPP/PPPs configuration.

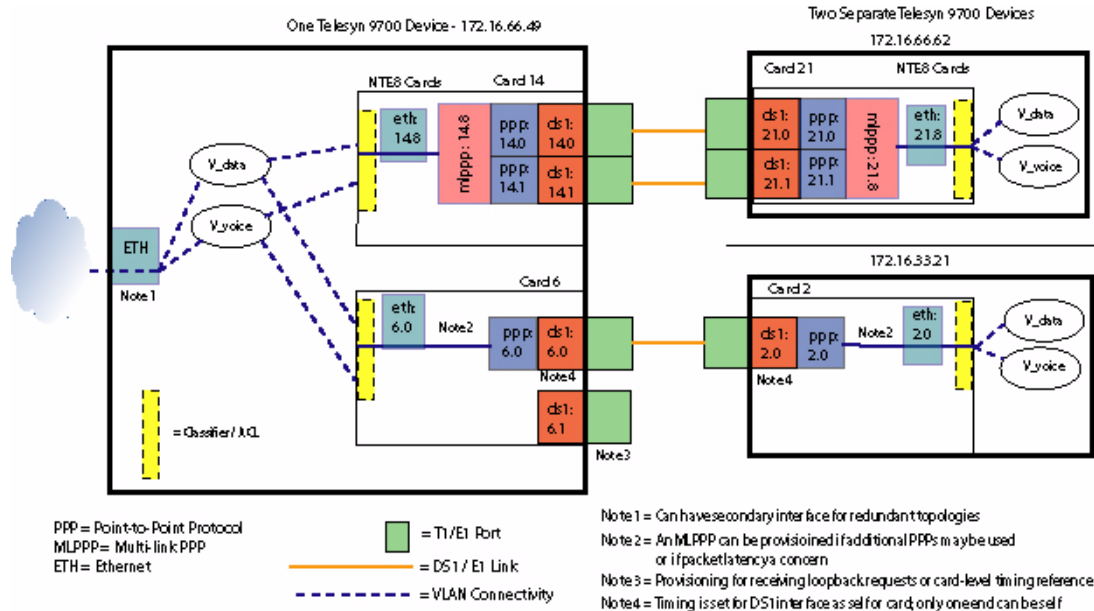

FIGURE 6-216 NTE Sample Configuration - Cards 5 and 1 used in Example

6.17.1 Main Provisioning Steps

The recommended steps for provisioning the NTE8 when there are no MLPPPs (PPPs only) are:

1. Create the NTE8 cards and provision them to support DS1.
2. Create a DS1/E1 port profile (refer to 6.10.2).
3. Right click a device from the Physical Map and then **Provision -> Port Management**.
4. On the Port Management form, select an unprovisioned NTE8 port and select **Provision New Customer/Port**
5. On the Provision New NTE-DS1 Port form, create a useful Customer ID.
6. Set DS1 parameters by selecting a Port Profile. If you don't use a profile, the default values will be used.
7. Fill in the Peer Port panel with the Device and Slot-Port to choose a far-end ("Z-end") for the circuit.

Note: Since these DS1s are to be connected, the timing source is coordinated between them; if one end is set as SELF, the other end automatically changes to CARD.

8. Edit the PPP parameters, if desired. **These will be applied to both ends.**
9. Since this is for a PPP circuit, without MLPPP, do not edit the MLPPP interface parameters.
10. Select the VLAN that this PPP is to be connected to. **Note: the VLANs must already be configured.**
11. Press the Provision Button when complete.

The procedure for configuring an MLPPP for both ends is:

1. Create a PPP circuit as listed above, up to step 7.

2. Select an MLPPP Interface to use for the bundle.

Note: The selection is constrained by MLPPP bundle consistency on both ends; once a PPP is associated with an MLPPP, the peer PPP must be associated with the peer MLPPP. This will become clear in the examples.

6.17.2 Create/Provision NTE8 cards to Support DS1 Ports (Different Devices)

To create the cards (if this hasn't been done already), right click on the device and select **Provision -> Card Management**, which brings up the **Card Management Form**. Find the Slot (in this case 14) that is not provisioned, and select **Create Card**. Select the Profile as AutoProv if you wish the card to use the load that is in the AutoProv profile, the Admin State as UP (assuming you want the card to go into service), and the Ports Type as DS1. (If not explicitly chosen, DS1 is the default.) Click on **Create**, and the card status will change in the Card Management form to a Card Type of NTE8.

Note: The card timing is initially Internal, as the only item in the pull-down. However, a DS1 port could be created that is connected to a system-wide, external timing source (with its timing source set to SELF). The user could then change the timing source for the card to that DS1 port. At this point you can download any NTE8 files if the Profile was set to Manually Provisioned.

Note: At this point, the card attribute Ports Type for the General Tab can be changed, but the card would need to be disabled, and there is a warning about the need to disable the card. The Profile can also be changed, and there is a warning that such a change will destroy existing provisioning data.

6.17.3 Create DS1 Profile

When a DS1 port is provisioned, a DS1 profile must already exist so it can be associated with the DS1 port. An overview of Profiles is in 6.10. In this example a profile called NTE_ds1_profile is created. The following figures show the profile has already been created and can be viewed in the Profile table by double-clicking on the profile row.

Note: When a QoS Policy is applied to a DS1 port in the NTE8 configuration, it is actually applied to the ETH interface, which may contain one or more DS1/E1 interfaces. If different policies are applied to the multiple DS1s/E1s, the last policy applied will be applied to the ETH interface and therefore to all the DS1s/E1s.

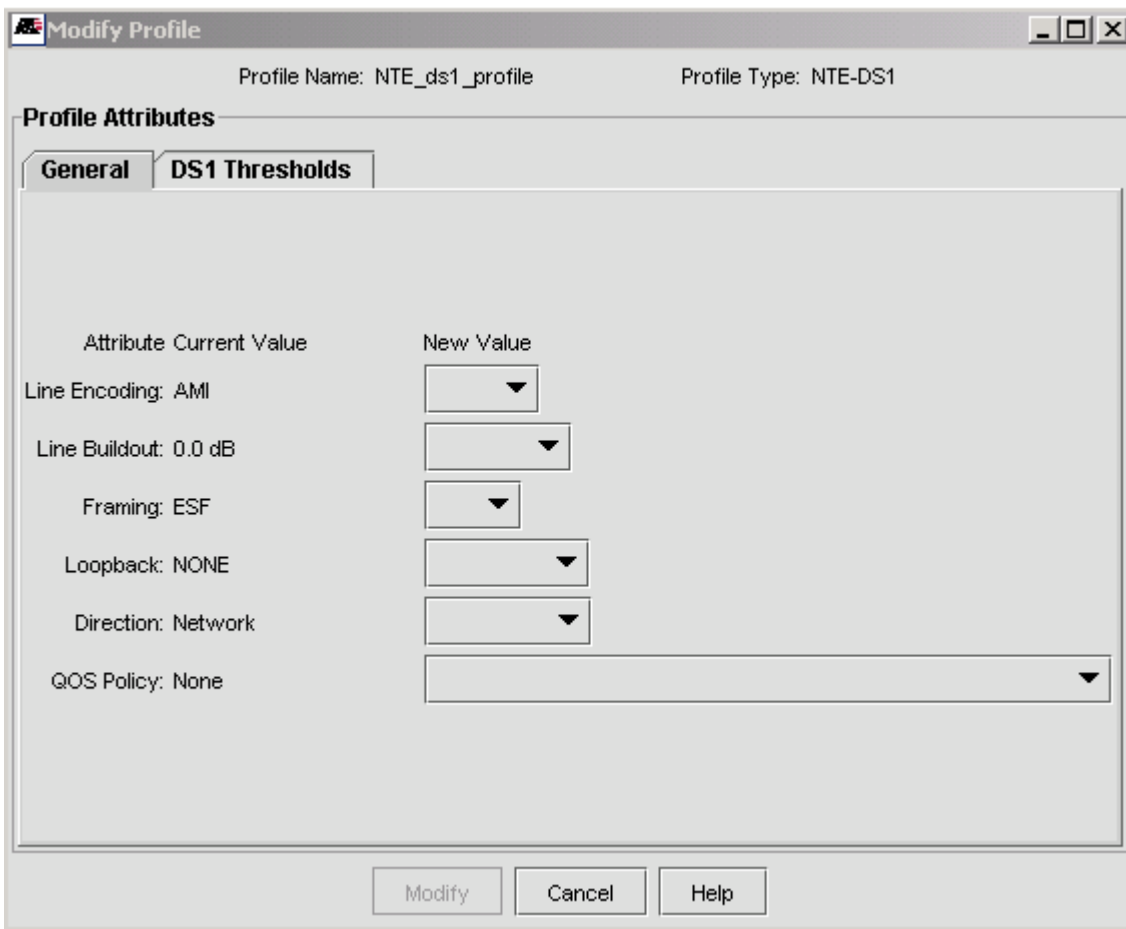

FIGURE 6-217 Viewing DS1 Profile - General Tab

Modify Profile

Profile Name: NTE_ds1_profile Profile Type: NTE-DS1

Profile Attributes

General DS1 Thresholds

Near-End 15-min Thresholds

	Current Value	New Value
Line Errored Seconds - ES-L (0..900):	15	<input type="text"/>
Line Severely Errored Seconds - SES-L (0..900):	30	<input type="text"/>
Unavailable Seconds - UAS (0..900):	45	<input type="text"/>
Line Coding Violations - CV-L (0..32767):	0	<input type="text"/>
Path Errored Seconds - ES-P (0..900):	0	<input type="text"/>
Path Severely Errored Seconds - SES-P (0..900):	0	<input type="text"/>
Path Coding Violations - CV-P (0..32767):	0	<input type="text"/>
Path Failure Counts - FC-P (0..32767):	0	<input type="text"/>
Path Errored Seconds, Type A - ESA-P (0..900):	0	<input type="text"/>
Path AIS Seconds - AISS-P (0..900):	0	<input type="text"/>

Modify Cancel Help

FIGURE 6-218 Viewing DS1 Profile - DS1 Thresholds Tab (Note non-0 values)

6.17.4 Provisioning one NTE8 Circuit

Selecting from the main menu *Tools -> Customer Management -> Add NTE DS1 Customer* brings up the **Provision New NTE-DS1 Port** Form. This is the form where the main task for Provisioning the NTE8 endpoints are done.

*Note: You can also right click on the device and select **Provision -> Port Management**, and then on the **Port Management** form select an unprovisioned NTE8 port and click on **Provision new Customer/Port**. Note however that with these steps the device and port are already filled in and uneditable.*

The device/ports available are the discovered DS1 ports in the managed network that are available for provisioning. Following are important points when filling out this form:

- You must input a Customer ID. When provisioning dual endpoints, this ID will be applied to both endpoints in the Port Inventory table. This allows immediate recognition of which ports are included in the dual configuration. The name should be descriptive so that users know this is part of a dual endpoint configuration.
- The Port Profiles used for each endpoint do not have to match, but care must be taken to ensure that the values are compatible.
- When the user selects an MLPPP instance for the near-end and is provisioning the MLPPP for the first time, the user selects an MLPPP that is EMPTY (No PPP members) and NEW (not yet created). (Adding a link to an already existing MLPPP is covered in the next subsection.)
- To provision the far end port, the user selects an appropriate device and port, and must select the MLPPP that can exist on the same card as the port. The example shows what is most common, with the 21.0 port being provisioned with the lowest number MLPPP available, 21.8.

- When the user clicks on **Provision**, the task completes, and the user selects **Yes** to continue data filling the form, the Customer ID field is cleared and the just provisioned ports are no longer available in the Port pull-down. Refer to the following figures.

Note: Any specified QoS Policy is applied to the common Ethernet interface.

The screenshot shows a configuration window titled "Provision New NTE-DS1 Port". At the top, there is a "Description (Customer ID)" field with the value "NTE_DS1_0".

Port Configuration:

- Device: 172.16.66.49
- Slot.Port: 14.0
- Port Profile: NTE_ds1_profile
- MLPPP Instance: MLPPP : 14 . 8 Empty New
- Timing Reference: CARD

PPP Configuration:

- PPP Parameters:**
 - Restart Interval: 3 sec
 - Max Configure: 10 attempts
 - Max Terminate: 2 attempts
 - Max Failure: 5 attempts
 - Echo Interval: 1 sec
- MLPPP Parameters:**
 - Segment Size: 512 octets
 - Delay Tolerance: 25 ms
 - Sequence Number Bits: 24 bits
- VLAN Parameters:**
 - Untagged Vlan: (empty) VID
 - Tagged Vlans: 700 VIDs

Peer Port Configuration (optional):

- Device: 172.16.66.62
- Slot.Port: 21.0
- Port Profile: NTE_ds1_profile
- MLPPP Instance: MLPPP : 21 . 8 Empty New
- Timing Reference: SELF

Schedule:

- Now (selected), Hold, Schedule
- Date: Oct 6, 2005
- Time: 4:20 PM

Buttons at the bottom: Provision, Recent Commands..., Close, Help.

FIGURE 6-219 Provision a New NTE-DS1 Port (MLPPP)

The screenshot shows the 'Provision New NTE-DS1 Port' window. The 'Description (Customer ID)' is 'NTE_DS1_0'. The 'Port Configuration' section shows 'Device: 172.16.66.49', 'Slot.Port: 14.0', 'Port Profile: NTE_ds1_profile', and 'MLPPP Instance: MLPPP : 14 . 8 Empty New'. The 'PPP Configuration' section includes 'PPP Parameters' (Restart Interval: 3 sec, Max Configure: 10 attempts, Max Terminate: 2, Max Failure: 5, Echo Interval: 1) and 'MLPPP Parameters' (Segment Size: 512 octets, Delay Tolerance: 25 ms). A dialog box titled 'Provisioning Successful!' is overlaid, asking 'Do you wish to provision another new subscriber?' with 'Yes' and 'No' buttons. The 'Peer Port Configuration (optional)' section shows 'Device: 172.16.66.62', 'Slot.Port: 21.0', 'Port Profile: NTE_ds1_profile', and 'MLPPP Instance: MLPPP : 21 . 8 Empty New'. The 'Schedule' section has 'Now' selected. At the bottom are buttons for 'Provision', 'Recent Commands...', 'Close', and 'Help'.

FIGURE 6-220 Result of Success (Fields Ready for next Customer)

6.17.5 Adding PPPs to the MLPPP

Once the NTE8 DS1 circuit has been set up, with a PPP and associated MLPPP at each end, the user can add DS1s/PPPs to the existing MLPPPs. By filling out the NTE provisioning forms, the user can ensure the provisioning goes smoothly and the correct parameters are entered.

Refer to the following figure while reading below.

To provision the second DS1s/PPPs, right click on the relevant device, in this case the .49 device, and select **Provision -> Port Management**. In the Port Management form, select the DS1 that is going to be added (in this case, 14.1). This PPP is being added to MLPPP 14.8, so the user chooses this MLPPP from the pull-down. Note that the MLPPP already contains the PPP 14.0 and has already been configured (LINK).

Once the user chooses this MLPPP, the peer MLPPP is **automatically** datafilled in, since in any set of PPP pairs, the PPPs on one side must have the same peer MLPPP.

Provision New NTE-DS1 Port

Description (Customer ID): nte_DS1_1

Port Configuration

Device: 172.16.66.49 Slot Port: 14.1 Port Profile: NTE_ds1_profile
 MLPPP Instance: MLPPP: 14.8 14.0 Link Timing Reference: CARD

PPP Configuration

PPP Parameters		MLPPP Parameters	
Restart Interval: 3 sec		Segment Size: 512 octets	
Max Configure: 10 attempts		Delay Tolerance: 25 ms	
Max Terminate: 2 attempts		Sequence Number Bits: 24 bits	
Max Failure: 5 attempts			
Echo Interval: 1 sec		VLAN Parameters	
		Untagged Vlan:	VID
		Tagged Vlan: 700	VIDs

Peer Port Configuration (optional)

Device: 172.16.66.62 Slot Port: 21.1 Port Profile: NTE_ds1_profile
 MLPPP Instance: MLPPP: 21.8 21.0 Link Timing Reference: SELF

Schedule

Now Hold Schedule: Oct 6, 2005 4 32 PM

Provision Recent Commands... Close Help

FIGURE 6-221 Provision New NTE-DS1 Port - Dual PPP

6.17.6 Viewing Provisioning Results - Port Inventory Table

To see the results of the dual endpoint provisioning, go to the Port Inventory window and sort on the Customer ID. The two ports are placed together since they share the same Customer ID. Refer to the following figure.

Note: The user can also go to the Port Management window for the device and sort on Customer ID.

Devices	Port	Type	Customer ID	Status	Profile
172.16.66.49	14.0	NTE-DS1	NTE_DS1_0	Clear	NTE_ds1_profile
172.16.66.49	14.1	NTE-DS1	NTE_DS1_1	Clear	NTE_ds1_profile
172.16.66.62	21.0	NTE-DS1	NTE_DS1_0	Clear	NTE_ds1_profile
172.16.66.62	21.1	NTE-DS1	NTE_DS1_1	Clear	NTE_ds1_profile
172.16.33.4	1.1	Ether-like		Clear	
172.16.33.4	1.10	Ether-like		Clear	

FIGURE 6-222 Viewing Dual Endpoints on Port Management - Same Customer ID on Different Devices

This shows that ports 14.0 and 21.0 are the endpoints of one pair (Customer ID NTE_DS1_0) and ports 14.1 and 21.1 are the endpoints of the other pair (Customer ID NTE_DS1_1). By double-clicking on either of these rows, the DS1 Port Management tabbed form appears, with the selected port on the left. One can then view/modify the details of the configuration.

Note: In this tabbed form, it is possible to change the attributes of the endpoints, However, in most cases the user should plan the dual endpoints so that configuration is easy and less prone to error.

6.17.7 Viewing Provisioning Results - Port Details Form

6.17.7.1 DS1 Port Tab

The following figure shows the Port Management form that appears when the user double-clicks on port 14.0 in the Port Inventory Form.

The port 14.0 is on the left, since that is the row that was selected; if the user selected 21.0 on the other device, port 21.0 would appear on the left.

The user can change attributes that are part of the Profile, but after clicking on Modify the user would see the Profile with an ‘*’ next to it, meaning the Profile is out-of-sync. (This would also show up in the port inventory table.) The user would need to re-apply the profile make the ‘*’ disappear.

The user can change the Description (Customer ID), but that would disassociate the two endpoints.

Note: The DS1 tab shows only the implicit connection between the endpoints; it is the PPP tab that explicitly ties the two endpoints together, discussed below.

The screenshot displays the 'NTE-DS1 Port Management' window with the 'DS1' tab selected. It compares two DS1 ports: one on device 172.16.66.49 (Slot:Port: 14.0) and another on device 172.16.66.62 (Slot:Port: 21.0). Both ports are in an 'Up' state and are 'Online'. The configuration parameters for both ports are identical, including a description of 'NTE_DS1_0', timing reference of 'CARD', profile of 'NTE_ds1_profile', line encoding of 'AMI', line build out of '0.0DB', framing of 'ESF', and direction of 'Network'. Loopback settings are also consistent, with status 'OFF' and type/location 'Unknown'. At the bottom, there are control buttons for 'Modify', 'Disable', 'Enable', 'Alarms...', 'Clear Entry Fields', 'Recent Commands...', 'Close', and 'Help'. A status bar at the very bottom shows two successful polling messages from October 6, 2005.

Device	Slot:Port	Device	Slot:Port
172.16.66.49	14.0	172.16.66.62	21.0
Admin. State/Status: Up		Up	
Oper. State/Link State: Up		Up	
Status: Online		Online	
Type: NTE-DS1		NTE-DS1	
Description (Customer ID): NTE_DS1_0		NTE_DS1_0	
Timing Reference: CARD		SELF	
Profile: NTE_ds1_profile		NTE_ds1_profile	
Line Encoding: AMI		AMI	
Line Build Out: 0.0DB		0.0DB	
Framing: ESF		ESF	
Direction: Network		Network	
Loopback Status: OFF		OFF	
Loopback Type: Unknown		Unknown	
Loopback Location: Unknown		Unknown	

Buttons:

Buttons:

Log: Thu Oct 06 16:49:55 EDT 2005 - Polling of 172.16.66.49 successful.
Thu Oct 06 16:49:47 EDT 2005 - Polling of 172.16.66.62 successful.

FIGURE 6-223 DS1 Tab for NTE Example

6.17.7.2 PPP Tab

The following figure shows the PPP tab for the two endpoints.

As with the DS1 tab, the row selected is the port that appears on the left.

The main attributes of the PPPs are at the top of the form and are read only.

Note that the pull-down for the MLPPP includes the currently configured MLPPP and its connection to its peer MLPPP (MLPPP 21.8).

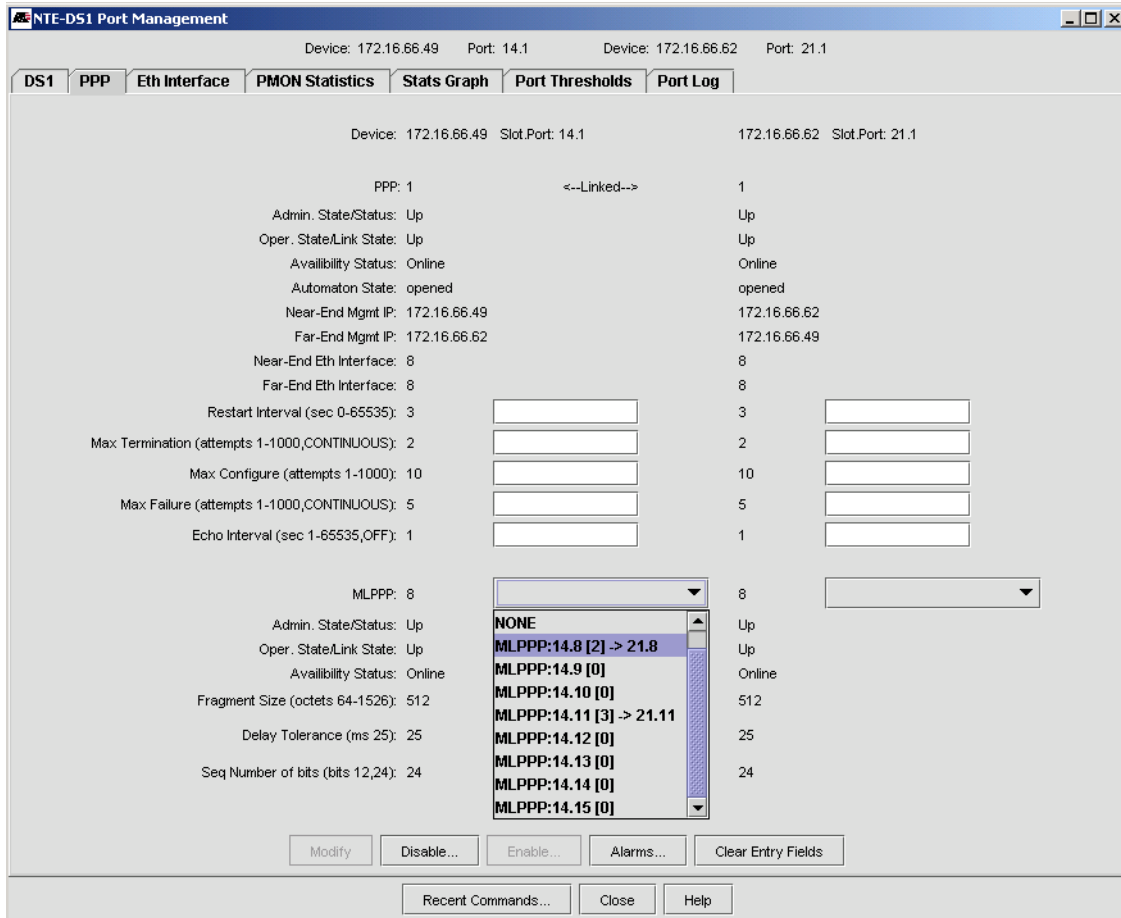

FIGURE 6-224 PPP Tab for NTE Example

6.17.7.3 Eth Interface Tab

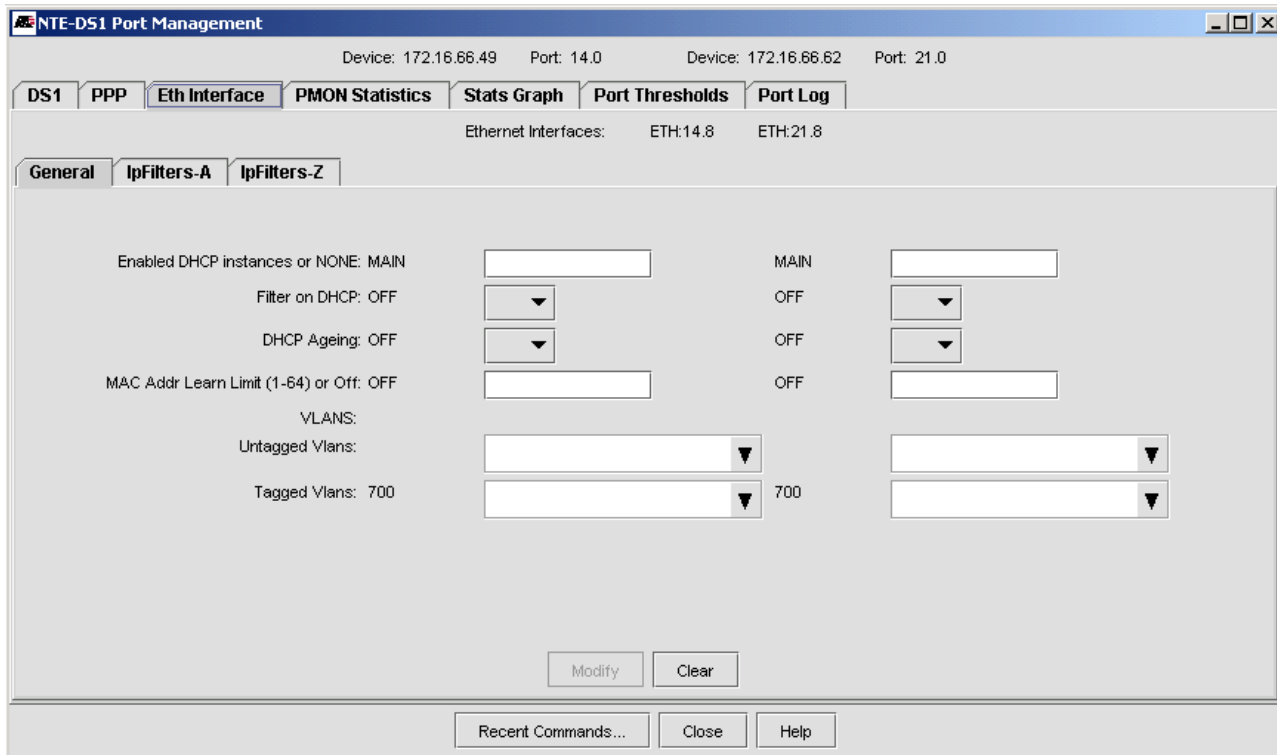

FIGURE 6-225 Eth Interface tab for NTE Example

6.17.7.4 PMON Statistics Tab

This tab shows the PMON Statistics tab. Refer to the following figure.

Note that the table lists the 14.0 and 21.0 Port statistics together.

When the user presses the function buttons (Enable, Disable, etc.), they are applied to **both** ports.

The screenshot displays the 'NTE-DS1 Port Management' window. At the top, it shows 'Device: 172.16.66.49 Port: 14.0' and 'Device: 172.16.66.62 Port: 21.0'. The 'PMON Statistics' tab is selected, showing a table of performance metrics for both ports. Below the table are buttons for 'Enable Statistics', 'Disable Statistics', and 'Reset PMON Statistics'. At the bottom, there are buttons for 'Recent Commands...', 'Close', and 'Help'. A status bar at the very bottom indicates 'Thu Oct 06 17:27:30 EDT 2005 - Polling of 172.16.66.49 successful.'

Name	Current 15 Min.	Current Day	Current 15 Min.	Current Day
LOSS (Loss of Signal Seconds)	0	1	0	0
Line ES (Errored Seconds)	8	180	0	0
Line SES (Severely Errored Seconds)	0	1	0	0
UAS (Unavailable Seconds)	0	0	0	0
Line CV (Code Violations)	8	180	0	0
Path ES (Errored Seconds)	0	4	0	0
Path SES (Severely Errored Seconds)	0	4	0	0
Path CV (Coding Violations)	0	0	0	0
Path FC (Failure Counts)	0	1	0	0
Path ESA (Errored Seconds type A)	0	0	0	0
Path AIS (Alarm Indication Seconds)	0	4	0	0
PPP Current Sent Echo Requests	0	0	0	0
PPP Failed Echo Requests	0	0	0	0
Total Received Packets		N/A		N/A
Received Broadcast Packets		N/A		N/A
Received Multicast Packets		N/A		N/A
Sent Broadcast Packets		N/A		N/A
Sent Unicast Packets		N/A		N/A
Sent Multicast Packets		N/A		N/A

FIGURE 6-226 PMON Statistics Tab for two Endpoints

6.17.7.5 Stats Graph Tab

This form makes graphs of the statistics and allows the stats used to be saved as a list and reloaded later. Refer to the following figure.

Note: The statistics for each endpoint have the suffix **-A** or **-Z** to identify each one. The **-A** is the port on the left side of the two ports shown at the top of the form, and the **-Z** is the right side.

Note: The statistics counters may need to be enabled first on the device. This is done from the **PMON Statistics** tab, described in 6.17.7.4.

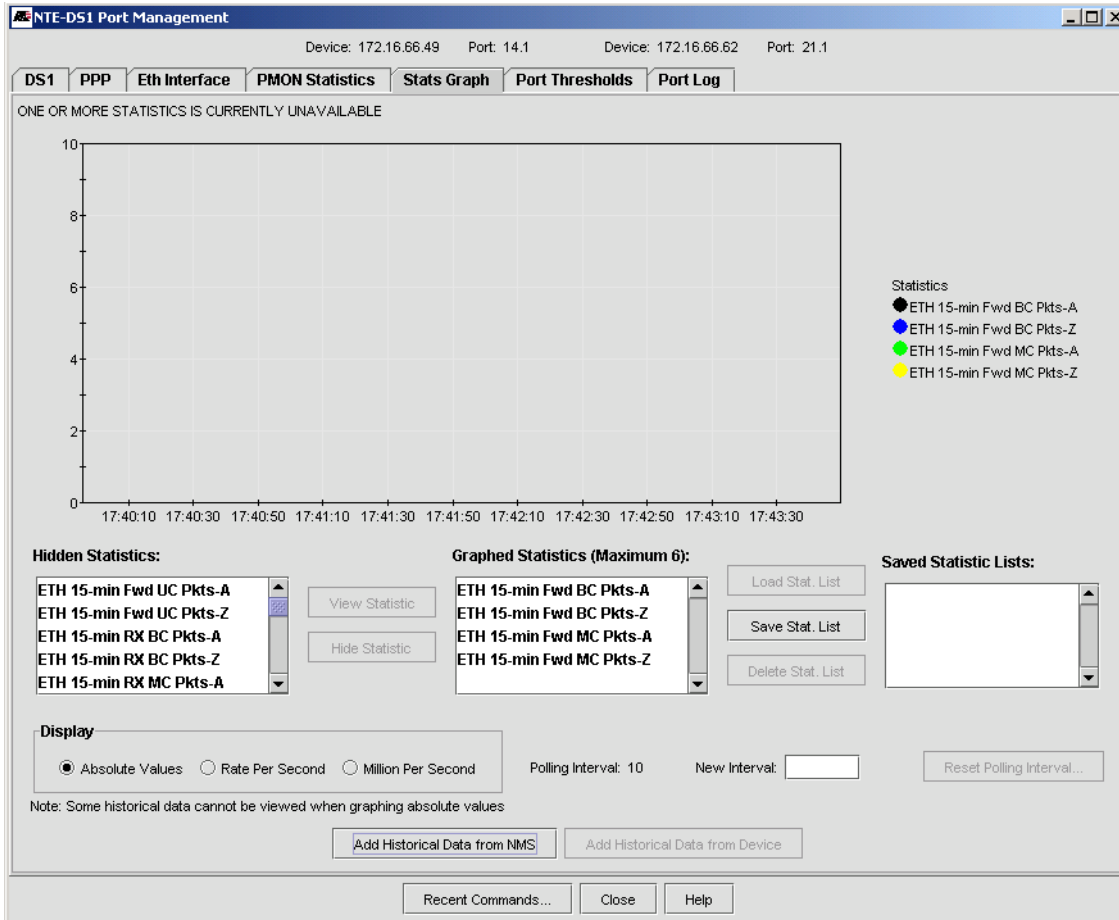

FIGURE 6-227 Stats Graph Tab for two Endpoints

6.17.7.6 Port Thresholds Tab

This form allows the user to modify the threshold values for the DS1/E1 and PPP statistics. When a new value is entered in the New Value field, the Modify button is enabled. These thresholds are set on the device and when crossed will cause thresholds crossing traps to be sent to the AlliedView NMS. These are displayed in the Event/Alarm tables.

Note: In most cases, the DS1/E1 values are not modified because they are part of the DS1/E1 port profile; if the user does change a value, the port is now out of sync with its associated profile, and an "" will appear next to the Profile name on the DS1/E1 Port tab form (as well as the Port Inventory table). In the dual endpoint configuration, the "*" will appear next to the specific port where the values were changed from the Profile. To Resync the port, the user must re-apply the profile on the DS1/E1 tab form, which puts the values back to what they are in the Profile.*

The screenshot shows the 'NTE-DS1 Port Management' window with the 'Port Thresholds' tab selected. It displays two endpoints: Device: 172.16.66.49 Port: 14.0 and Device: 172.16.66.62 Port: 21.0. The interface is divided into two sections: 'NTE-DS1 Thresholds' and 'PPP Thresholds'. Each section has a table with 'Current Value' and 'New Value' columns. The 'NTE-DS1 Thresholds' section includes metrics like Line Errored Seconds, Line Severely Errored Seconds, Unavailable Seconds, Line Coding Violations, Path Errored Seconds, Path Severely Errored Seconds, Path Coding Violations, Path Failure Counts, Path Errored Seconds (Type A), and Path AIS Seconds. The 'PPP Thresholds' section includes Sent Echo Requests and Failed Echo Requests. At the bottom, there are buttons for 'Modify', 'Clear Entry Fields', 'Recent Commands...', 'Close', and 'Help'. A status bar at the very bottom indicates 'Thu Oct 06 17:28:29 EDT 2005 - Polling of 172.16.66.49 successful.'

	172.16.66.49 Slot:Port: 14.0		172.16.66.62 Slot:Port: 21.0	
	Current Value	New Value	Current Value	New Value
Line Errored Seconds - ES-L (0..900):	15	<input type="text"/>	15	<input type="text"/>
Line Severely Errored Seconds - SES-L (0..900):	30	<input type="text"/>	30	<input type="text"/>
Unavailable Seconds - UAS (0..900):	45	<input type="text"/>	45	<input type="text"/>
Line Coding Violations - CV-L (0..32767):	0	<input type="text"/>	0	<input type="text"/>
Path Errored Seconds - ES-P (0..900):	0	<input type="text"/>	0	<input type="text"/>
Path Severely Errored Seconds - SES-P (0..900):	0	<input type="text"/>	0	<input type="text"/>
Path Coding Violations - CV-P (0..32767):	0	<input type="text"/>	0	<input type="text"/>
Path Failure Counts - FC-P (0..32767):	0	<input type="text"/>	0	<input type="text"/>
Path Errored Seconds, Type A - ESA-P (0..900):	0	<input type="text"/>	0	<input type="text"/>
Path AIS Seconds - AISS-P (0..900):	0	<input type="text"/>	0	<input type="text"/>

	Current Value	New Value	Current Value	New Value
Sent Echo Requests (0..32767):	0	<input type="text"/>	0	<input type="text"/>
Failed Echo Requests (0..32767):	0	<input type="text"/>	0	<input type="text"/>

FIGURE 6-228 Port Thresholds Graph Tab for two Endpoints

6.17.7.7 Port Log Tag

The following figure shows the Port Log tab for the two endpoints. These entries are derived from the Syslog system.

NTE-DS1 Port Management							
Device: 172.16.66.49		Port: 14.0		Device: 172.16.66.62		Port: 21.0	
DS1	PPP	Eth Interface	PMON Statistics	Stats Graph	Port Thresholds	Port Log	
Device	Port	Severity	Category	Time	Sequence	Type	Message
172.16.66.49	14.0		PORT008	2005-10-06 16:24:44	6634	INFO	Location: Slot 14 Port: 0 Description: Provisioning applied to the port database
172.16.66.49	14.0		PORT008	2005-10-06 16:24:44	6632	INFO	Location: Slot 14 Port: 0 Description: Provisioning applied to the port database
172.16.66.49	14.0		PORT008	2005-10-06 16:24:48	6640	INFO	Location: Slot 14 Port: 0 Description: Provisioning applied to the port database
172.16.66.49	14.0		PORT008	2005-10-06 16:13:23	6595	INFO	Location: Slot 14 Port: 0 Description: Provisioning applied to the port database
172.16.66.49	14.0		PORT008	2005-10-06 16:13:24	6597	INFO	Location: Slot 14 Port: 0 Description: Provisioning applied to the port database
172.16.66.49	14.0		PORT007	2005-10-06 16:13:17	6588	INFO	Location: Slot 14 Port: 0 Description: Port state change From: UP-UP-Terminating To: DOWN-DOWN-Offline
172.16.66.49	14.0		PORT007	2005-10-06 16:13:16	6587	INFO	Location: Slot 14 Port: 0 Description: Port state change From: UP-UP-Online To: UP-UP-Terminating
172.16.66.49	14.0		PORT007	2005-10-06 16:24:51	6675	INFO	Location: Slot 14 Port: 0 Description: Port state change From: UP-UP-Online To: UP-DOWN-Failed
172.16.66.49	14.0		PORT007	2005-10-06 16:25:09	6686	INFO	Location: Slot 14 Port: 0 Description: Port state change From: UP-DOWN-Failed To: UP-UP-Online
172.16.66.49	14.0		PORT007	2005-10-06 16:24:51	6670	INFO	Location: Slot 14 Port: 0 Description: Port state change From: UP-DOWN-Configuring To: UP-UP-Online
172.16.66.49	14.0		PORT007	2005-10-06 16:24:51	6662	INFO	Location: Slot 14 Port: 0 Description: Port state change From: DOWN-DOWN-Offline To: UP-DOWN-Configuring
172.16.66.62	21.0		PORT008	2005-10-06 16:23:16	6210	INFO	Location: Slot 21 Port: 0 Description: Provisioning applied to the port database

FIGURE 6-229 Port Log Tab for two Endpoints

6.17.8 Viewing NTE8 Endpoints on Physical Map

Creation of PPP or MLPPP circuits through the NMS (or through CLI, directly) will trigger a discovery process on the devices so that they will know which Device and Port is currently at their far-end. This information is collected during NMS discovery of devices and will generate appropriate links on the Physical and VLAN maps, showing VLAN connectivity.

The following figure shows the Physical map and the physical link between the .20 and .18 devices. Double-clicking on the link brings up the Layer 2 Links table, and which includes all the link types (DS1, PPP, and MLPPP) that are included.

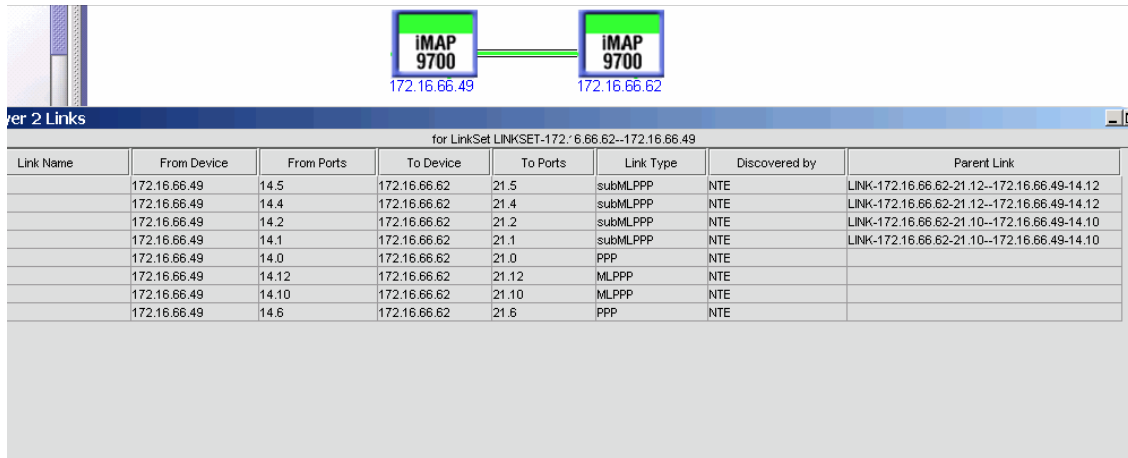

FIGURE 6-230 NTE8 Endpoints on the Physical Map

6.17.9 Viewing NTE8 Configuration Faults

When the NTE8 configuration is set up and running, faults can be generated on four components:

- NTE8 Card
- DS1/E1 port (such as LOS, LOF, Receiving AIS, etc.)
- PPP (Configuration Failure, Peer Disabled, etc.)
- MLPPP

Note: Refer to the iMAP User Guide for a complete description of these faults, and the iMAP Log Manual for a complete list of alarms.

Trap Parsers and/or Filter are used to receive and process the iMAP PPP/MLPPP link traps into NMS Events/Alarms. (For an overview of the Fault Management system, refer to Section 9.)

The traps are propagated as follows:

- DS1/E1 Port Alarms are generated from their corresponding Link down/up traps.
- PPP and MLPPP alarms are generated from their corresponding Link down/up traps. (Note PPPs of an MLPPP do not produce Link traps.)
- The Bandwidth Degraded alarm is generated when an interface defect trap is received from the iMAP.
- DS1/E1, PPP and MLPPP Link down/up traps are propagated to any of their associated VLANIFs and LINKs (including VLINK symbols on VLAN maps).
- MLPPP Bandwidth Degraded traps (when a PPP of an MLPPP goes down) are propagated to any of their associated VLANIFs and LINKs (including VLINK symbols on VLAN maps).

The screenshot shows a web-based interface for managing alarms. At the top, there is a header 'Alarms' with a bell icon. Below the header, there are controls for 'Total' (159), 'Displaying' (35), and 'to' (159). The main content is a table with two columns: 'Status' and 'Failure Object'. The 'Status' column contains the word 'Clear' in green text for each row. The 'Failure Object' column contains various identifiers for NTE endpoints, including MLPPP and PPP links on different ports, and LINK and VLANIF objects. The table is partially visible, showing the first seven rows.

Status	Failure Object
Clear	MLPPP_172.16.66.62_Port21.8 Link Up on ML
Clear	PPP_172.16.66.62_Port21.4 Link Up on PF
Clear	MLPPP_172.16.66.49_Port14.14 Link Up on ML
Clear	MLPPP_172.16.66.49_Port14.8 Link Up on ML
Clear	PPP_172.16.66.49_Port14.4 Link Up on PF
Clear	LINK-172.16.66.62-21.0--172.16.66.49-14.0_Node172.16.66.62_PPP21.0 Link PPP Prot
Clear	VLANIF-172.16.66.62-1 Port21.0 VLANIF Port I

FIGURE 6-231 Alarms Associated with NTE Endpoints

6.18 Upstream Control Protocol (UCP) Display

UCP is a proprietary protocol that informs other devices in the network that it is the “upstream node” for a UFO VLAN. Moreover, using UCP protocol messages, the non-upstream nodes for the UFO VLAN can dynamically determine their upstream interfaces. UCP actions occur independently of the topology feature being used; therefore, UCP can be used by itself as well as with EPSR.

Note: For a complete explanation of UCP and how it works with various topology features, refer to the iMAP Software User Manual.

The AlliedView NMS monitors for the UCP Node Type and Status Information. This includes:

- VLAN type (STD or Upstream)
- UCP Node Type (Primary, Secondary, Primary and Secondary, Upstream, Non-Upstream)
- UCP status (active, standby)

Node types are updated using SNMP traps from the relevant devices.

6.18.1 VLAN Submap Display

Each VLAN interface on a VLAN submap has a UCP Node-type label on top of the VLANIF symbol that can be one of the following for i MAP 6.0 devices:

- **p-ups** - Primary Upstream Node
- **s-ups** - Secondary Upstream Node
- **p&s-ups** - Primary and Secondary Upstream Node
- **non-ups** - Non-Upstream Node
- No text - the VLAN Interface is not in UFO mode; it is a standard VLAN.

Refer to the following figure. An upstream node is connected to a non-upstream node. The green color of the “p-ups” text indicates that the primary is currently active. If there were a secondary upstream node, it would be in a standby state and be indicated by a gray color.

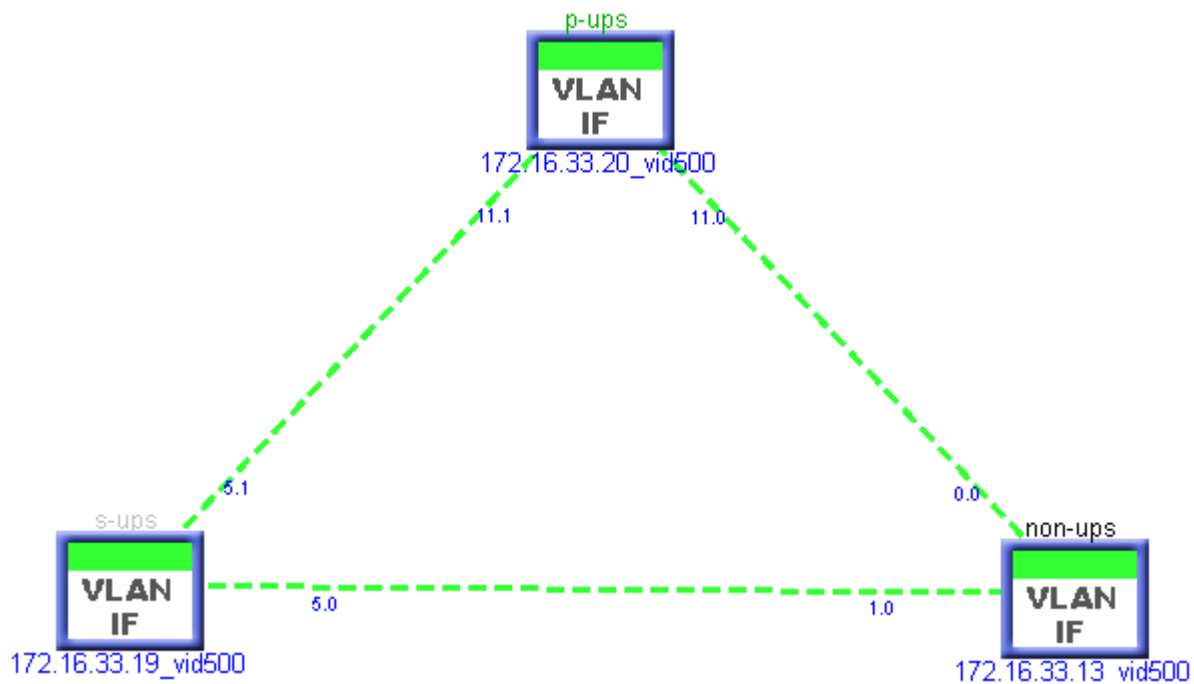

FIGURE 6-232 VLAN Interface Showing UCP Status

6.18.2 Network Inventory Display

This same information is also available in the VLAN IF inventory table. Refer to the following figure.

VIF Name	ID	Vlan Type	Type	VID	Status	UnTagged Ports	Tagged Ports	Devices	Network Vlan	Forwarding Mode	UCP Node Type	UCP Node Status
Vlan500	VLANIF-172.16.33.13-500	VLAN	VlanInterface	500	Clear	None	ETH:[0-1.0]	172.16.33.13	Vlan[2]	Upstream	Non-Upstream	
Vlan500	VLANIF-172.16.33.19-500	VLAN	VlanInterface	500	Clear	None	ETH:[4.0],[5.0-1]	172.16.33.19	Vlan[2]	Upstream	Sec-Upstream	standby
Vlan500	VLANIF-172.16.33.20-500	VLAN	VlanInterface	500	Clear	None	ETH:[2.1],[11.0-1]	172.16.33.20	Vlan[2]	Upstream	Pri-Upstream	active
default	VLANIF-172.16.33.13-1	VLAN	VlanInterface	1	Clear	ETH:[0-1.0],[7.0-7.0]...	None	172.16.33.13	Vlan[1]	Upstream	Pri-Upstream	active
default	VLANIF-172.16.33.19-1	VLAN	VlanInterface	1	Clear	ETH:[4-5.0-1],[0.0-1]...	None	172.16.33.19	Vlan[1]	Upstream	Pri-Upstream	standby
default	VLANIF-172.16.33.20-1	VLAN	VlanInterface	1	Clear	ETH:[2.1-9],[11.0-1]...	None	172.16.33.20	Vlan[1]	Standard		

FIGURE 6-233 UCP Status in the Network Inventory Table for the VLAN Interfaces (Highlighted)

6.18.3 Events View (Change of State)

When the active/standby status of the Primary/Secondary Node changes (because of failures in the network or administrative changes), SNMP traps are sent from the device indicating a state change. In the Events view, they appear as Info status events.

The following figures show how these changes are displayed.

Severity	Message	Date/Time
Info	UCP State-Change reported as Node_Type=secondary, Node_Status=standby	Apr 19,2005 10:00:50 AM
Minor	Unavailable seconds-line 15-minute t...	
Minor	Unavailable seconds-line 15-minute t...	
Info	UCP State-Change reported as Node...	
Info	UCP State-Change reported as Node...	

Allied Telesyn Event

Event Details

Index: 152856

Severity: Info

Message: UCP State-Change reported as Node_Type=primary, Node_Status=active - SNMP vars: atnUcpNodeType=1, atnUcpNodeStatus=1, atnVlanId=500

Category: VLAN

Node: 172.16.33.20

Failure Object: vLANIF-172.16.33.20-500_stateChange

Source: VLANIF-172.16.33.20-500

Date/Time: Apr 19,2005 09:59:01 AM

OK Close Help

Allied Telesyn Event

Event Details

Index: 152889

Severity: Info

Message: UCP State-Change reported as Node_Type=secondary, Node_Status=standby - SNMP vars: atnUcpNodeType=2, atnUcpNodeStatus=2, atnVlanId=500

Category: VLAN

Node: 172.16.33.19

Failure Object: vLANIF-172.16.33.19-500_stateChange

Source: VLANIF-172.16.33.19-500

Date/Time: Apr 19,2005 10:00:50 AM

OK Close Help

FIGURE 6-234 Events View when Change in UCP State (Highlighted)

Note: Since Events are part of Alarm Management, these events can be modified going through the Events Filter and can trigger various other events/alarms. Refer to Section 9.

These changes are also reflected in the VLANIF submap and the VLAN Interfaces Network Inventory table.

Note: To ensure that the status of the VLANs/interfaces is correct, the user can rediscover the relevant devices. This will appear in the Event view as a rediscovery, but if there are UCP-related changes, they will appear in the VLAN submap and Network Inventory table.

6.19 Link Discovery

For VLAN-related features of the NMS, such as the VLAN topology maps, EPSR, and UPC features, the NMS depends on accurate link information to piece together the broadcast domain for each extended VLAN.

The LLDP protocol is a feature on devices and this provides the information needed by the AlliedView NMS to provide the GUI for Link Discovery.

This subsection describes these interfaces and the specific functions Link Discovery.

- A Physical link between iMAPs will be automatically discovered if LLDP has been activated on its link ports at each end. Note that LLDP activation **must** be done once using the CLI on each interface for which links are to be discovered.
- New links are only updated during discovery/re-discovery of the devices.
- The user can still create links manually, but when a link is discovered via LLDP and this conflicts with at least one of the ports of a manually created link, the manually created link will be deleted and the LLDP link will be added. A warning event will be sent to indicate that a link was invalid and has been deleted. The same behavior will also occur when the existing link is a previously discovered link (rather than manually created) that has been changed.

All link details, including those for discovered links, can be viewed by double-clicking on the Linkset symbol on the Physical Map, or by selecting the Physical Links table in the Network Inventory. Refer to the following figures.

Note: To configure devices so that they support LLDP, refer to [5.3.13](#).

6.20 Software Upgrade with EPSR

6.20.1 Overview

Section 5.3.9 explains the software download application and how it can be used to control the download process for one or more devices and prevent errors.

A special situation occurs when the devices are part of an EPSR configuration, because the order in which the devices are downloaded will prevent service outage. Following are the rules/constraints that must be followed to ensure nodes in an EPSR configuration are upgraded without loss of service:

- Whenever a set of nodes is selected to be upgraded, if any of the nodes contain EPS Rings, it is possible that additional nodes, not specified in the original set, will have to be upgraded before the specified nodes.
- Any additional node of an EPSR may then have other EPSRs on it that require additional nodes to be upgraded before others.
- If any EPSR in the chain of EPSRs is misconfigured then it may not be possible to derive the upgrade order of its nodes. (The preferred order is: Master, Secondary Transit, around to Primary Transit.) It is possible that another valid EPSR will require a node from this invalid EPSR to be upgraded before the valid one can be upgraded.
- The upgrade of one node should be complete before the upgrade of another node is begun.
- If an EPSR is only partially managed, so that the topology is linear from Master to Secondary Transit, but not a complete ring back to the Primary Transit, then the partial ring should still be upgraded (under the assumption that any unmanaged remaining Transit nodes of the ring will be upgraded subsequently, either via CLI or another management system).
- Even when all EPSRs are valid there may still be loops in the precedence order (e.g., two EPSRs on the same ports, going in opposite directions will result in precedence loops.) Loops in the precedence order indicate that there is no order of upgrade among the nodes that will satisfy all EPSR's constraints. In this case, the user will have to modify or ignore certain EPSR vlans to form an upgradeable set of ring configurations.

In release 9.0, the download application is enhanced so that when a device is selected for download, the EPSR configuration is checked so that these rules are followed:

- If the devices chosen are part of an EPSR configuration, and there are no conflicts with the configuration rules listed above, the devices are upgraded in the proper order, and so service is not disrupted.
- If there is an ambiguity or conflict in the EPSR configuration, GUIs appear informing that the AlliedView NMS needs to resolve these conflicts before proceeding.
- If the selected device set does not include those that are part of the EPSR configuration, GUIs appear informing that the AlliedView NMS needs to include these devices before proceeding.
- If the EPSR has not been configured correctly initially, the feature cannot work, and a GUI with the appropriate error message appears; the user can choose to upgrade anyway if a potential loss of service is either acceptable or data traffic is not running over the VLANs.

Note: The Software Configuration feature is included in Section 5, since it can perform actions on a specific device. However, since this feature checks multiple devices it is considered a network service.

6.20.2 Upgrading all Nodes for an EPSR Ring

Following is an example that shows how the feature works when upgrading multiple devices that include an EPSR Control and Data VLAN. The administrator wishes to upgrade the three devices that make an EPSR ring, as shown in the following figures.

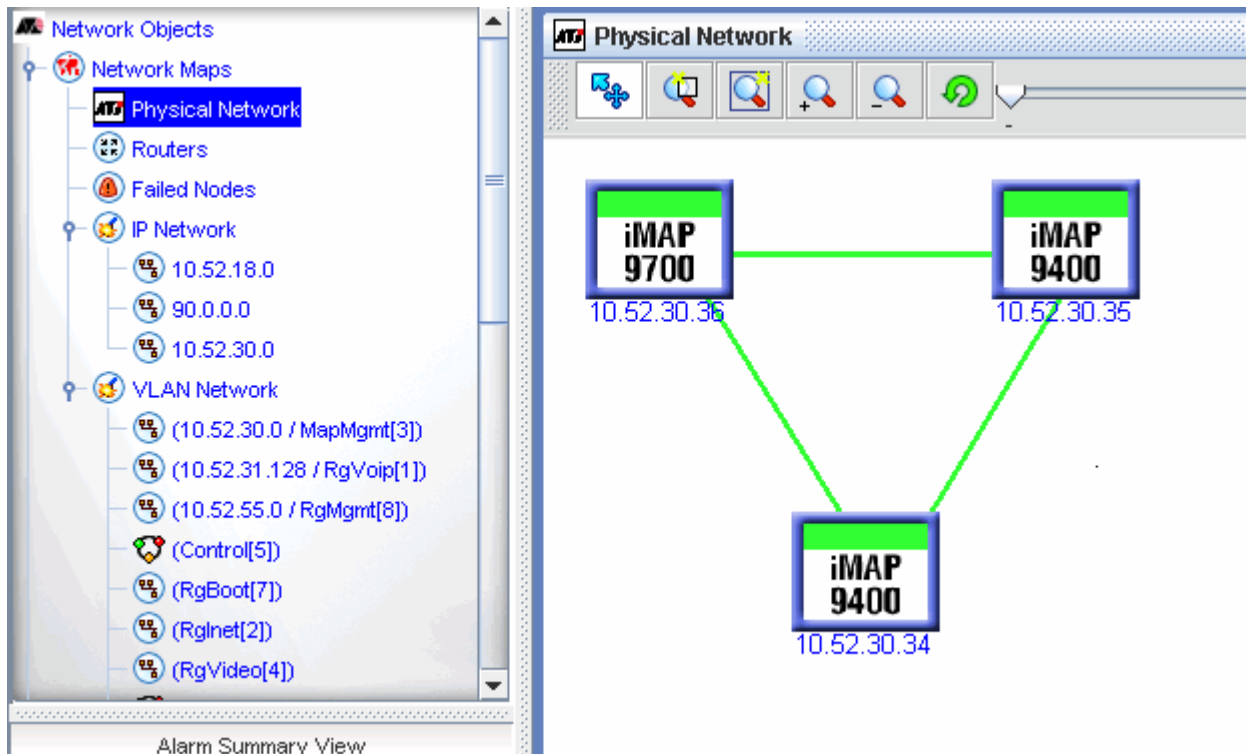

FIGURE 6-235 Physical Map showing Ring Configuration

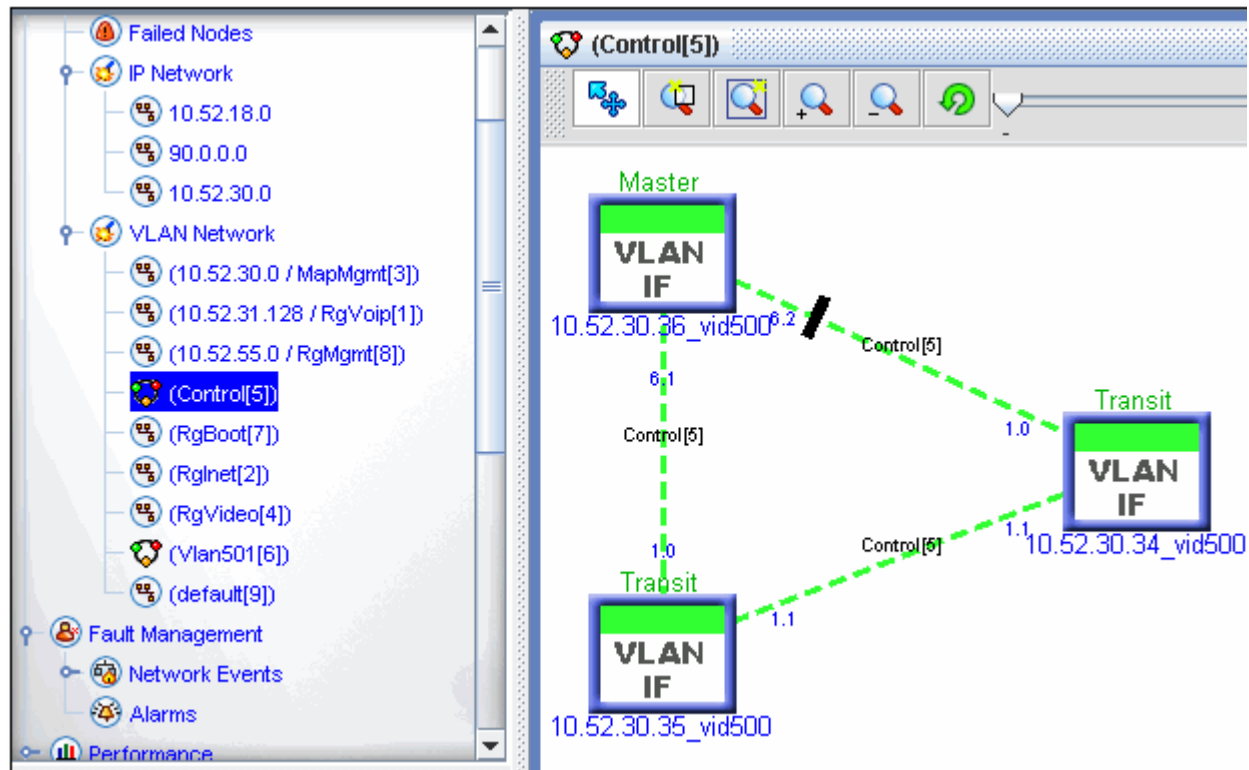

FIGURE 6-236 EPSR - Control VLAN over Physical Links

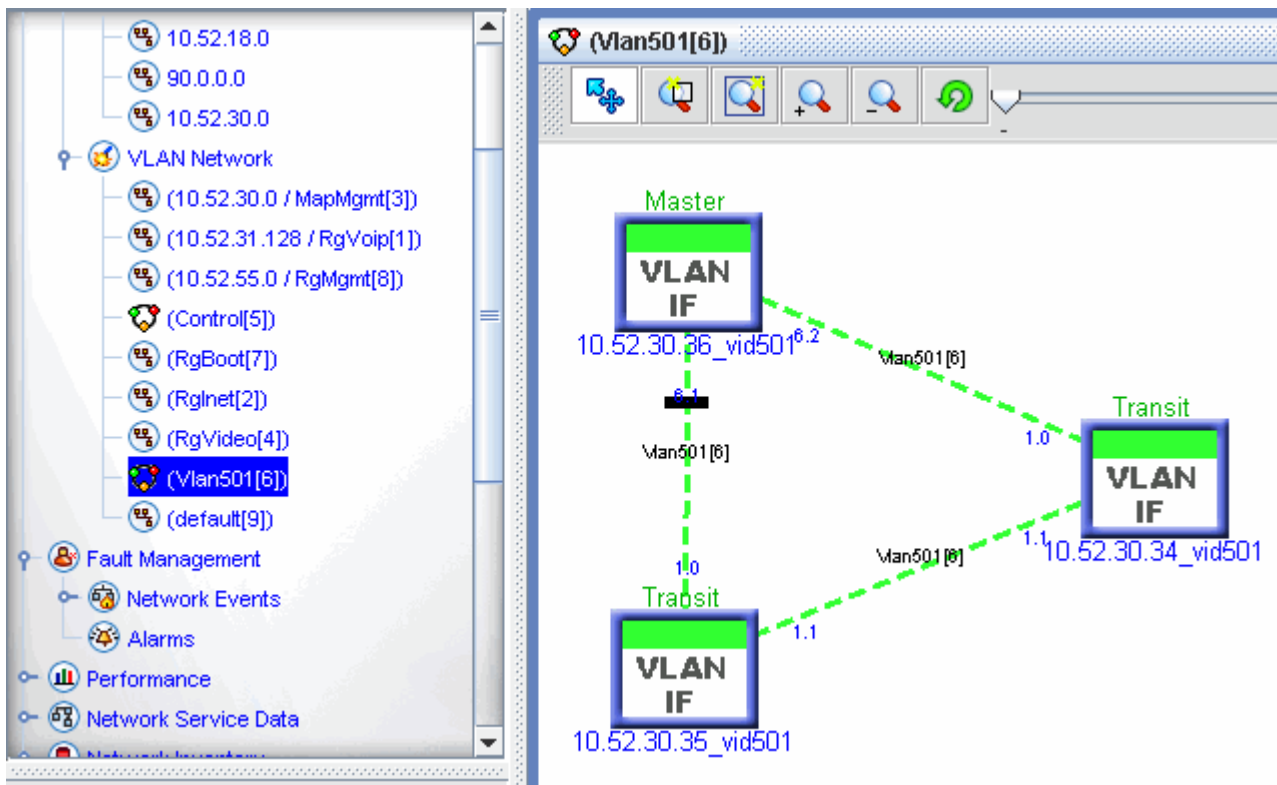

FIGURE 6-237 EPSR - Data VLAN over Physical Links

In the physical map, the user could highlight the three devices, right click and select Software Configuration. This would bring up the Software configuration with all three devices included, as shown below.

The screenshot shows the 'Software Configuration' window with a table of selected devices. The table has columns for Device, Type, Release, Patch, and other details. Three devices are selected and highlighted in green.

Device	Type	Release	Patch	
10.52.30.34	9400	cfc24_9.0.0.tar	N/A	Slot 10=9.0.0.ALPHA.20060821
10.52.30.35	9700-56	cfc56_9.0.0.tar	N/A	Slot 3=(ADSL48A); Slot 5=(VDS
10.52.30.36	9400	cfc24_8.0.4.tar	N/A	Slot 10=8.0.4(ADSL24A); Slot 5

FIGURE 6-238 Devices Chosen for Software Upgrade

The user would select all three devices and click on the now active **Modify Release Configuration** button. This would bring up the Modify Device Software Configuration window, as shown in the following figure and explained in 5.3.9.

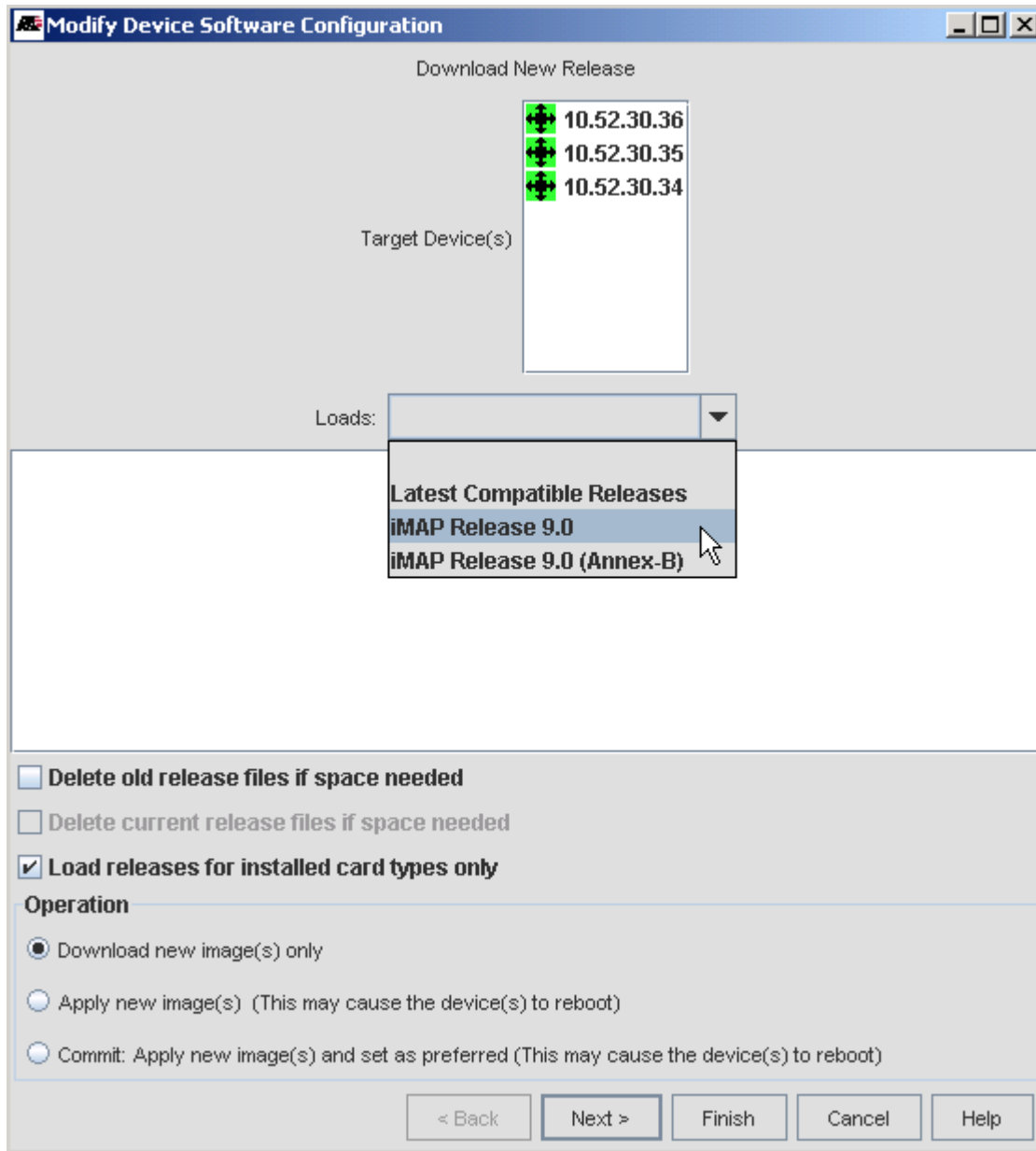

FIGURE 6-239 Modify Device Software Configuration Window - Select Load for Multiple Devices

When the user selects Next, the AlliedView NMS checks the EPSR configuration and, using the configuration rules listed above, determines the order in which the devices should be loaded. In this example, as the user clicks **Next**, the following screens appear, as shown in the following figures:

- EPSR Precedence Order is Ambiguous - If the user selects Next, the AlliedView NMS determines which of the two nodes to upgrade first.
- Remove Conflicting EPSR Loops - If the user selects Next, the AlliedView NMS determines which VLAN to ignore.

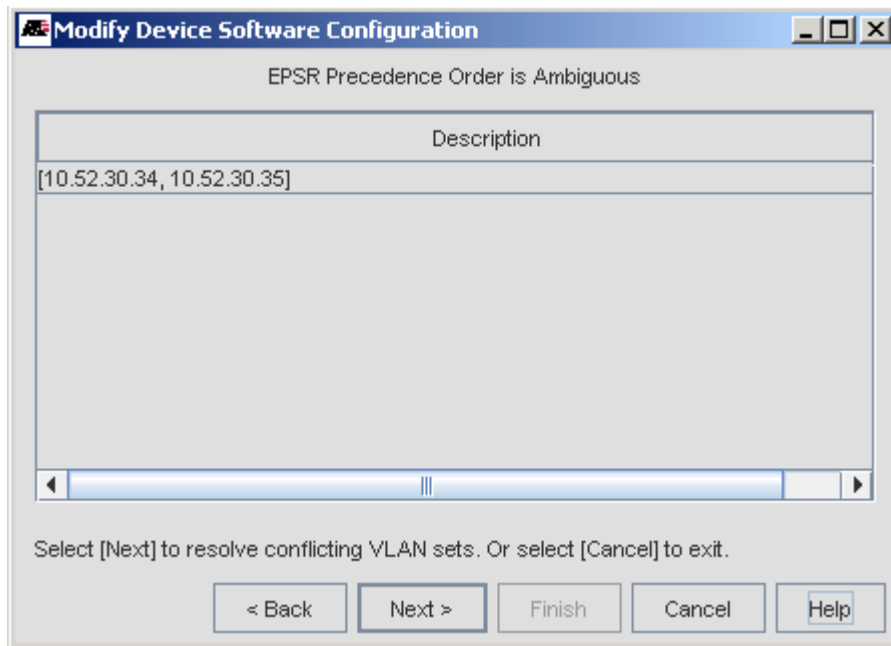

FIGURE 6-240 Resolving Conflicting VLAN Sets

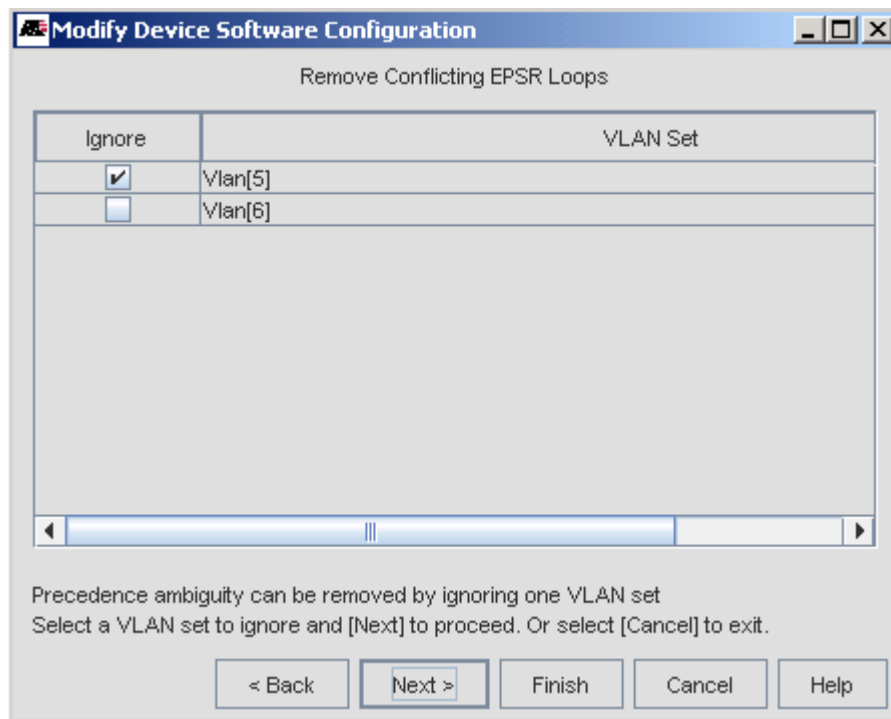

FIGURE 6-241 Selecting a VLAN to ignore during Upgrade

6.20.3 Upgrading One Node that is part of an EPSR Configuration

In the previous example, the EPSR configuration included three devices, and all three devices were selected for a software upgrade. If the user does not choose all the devices that take part in the EPSR configuration, the AlliedView NMS determines that additional devices must be upgraded as well. Two other GUIs may therefore appear while performing the upgrade sequence:

- Additional EPSR Successor Nodes Detected - A successor node must be included in the upgrade procedure. The user should ensure all the listed devices are checked and select Next.
- Additional EPSR Predecessor Nodes Detected - A predecessor node must be included in the upgrade procedure. The user should ensure all the listed devices are checked and select Next.

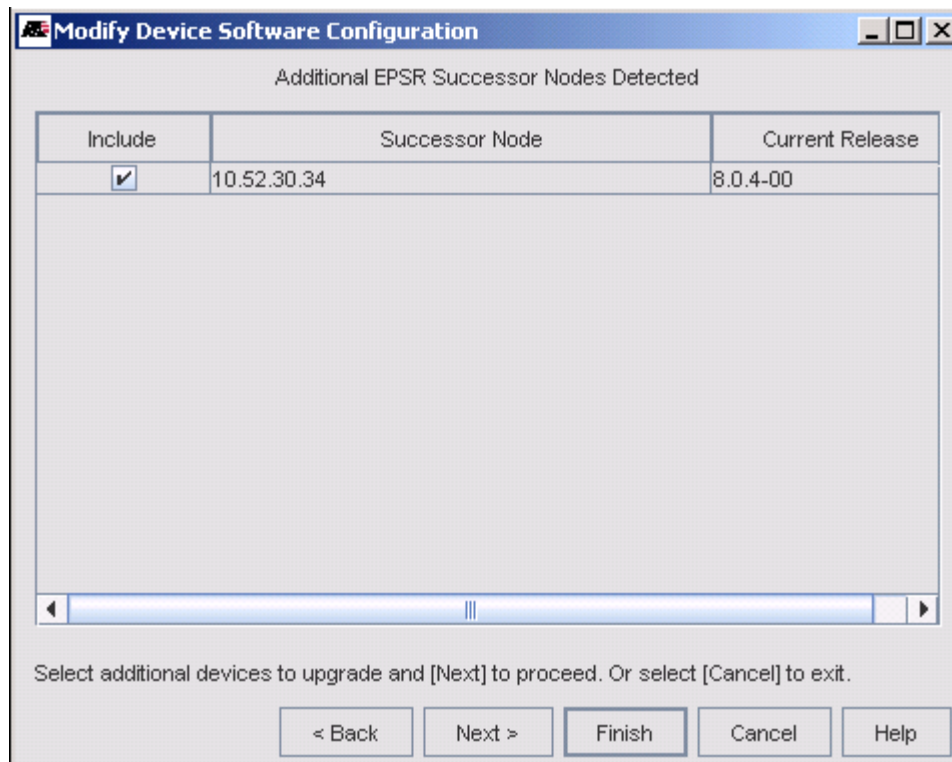

FIGURE 6-242 Select Additional Successor Devices to Upgrade

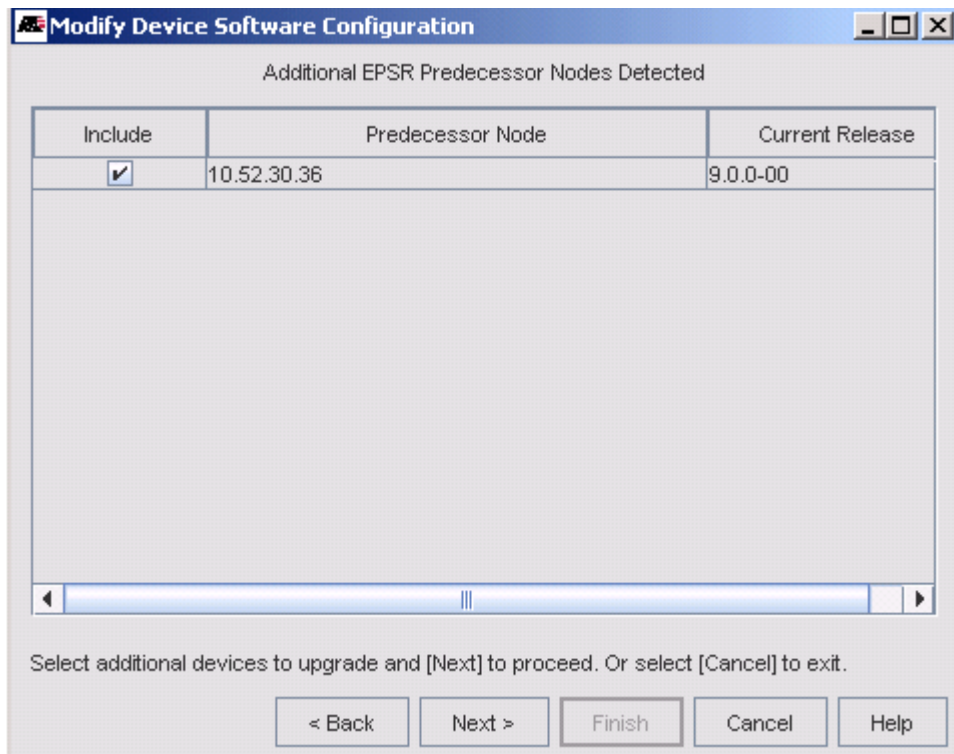

FIGURE 6-243 Select Additional Predecessor Devices to Upgrade

6.20.4 Upgrading Devices when EPSR not Properly Configured

If EPSR has been improperly configured and the user selects one or more devices to upgrade, a GUI with an error message appears that warns the user that if the error is not fixed the configuration will fail or data service may be disrupted. Refer to the following figure.

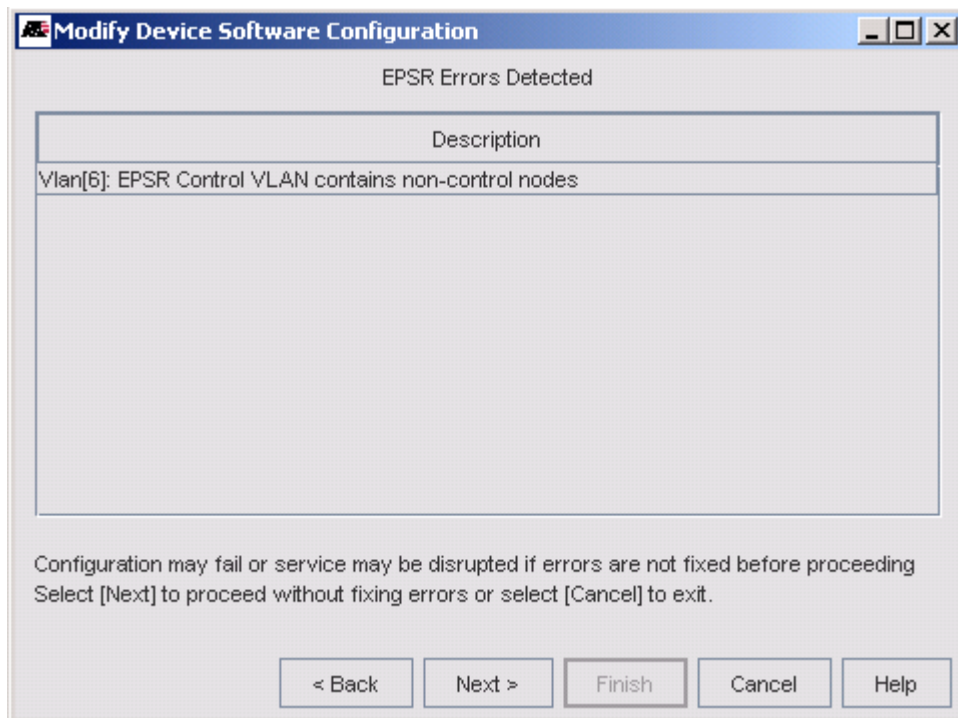

FIGURE 6-244 Error Condition for Upgrade

6.21 Diagnostic Audit

The NMS provides the capability to run diagnostic audits on certain network entities. Currently, the entities that can be audited are:

- Network VLANs
- CES Circuits

Audits are started from the “Diagnostic Audit Reporting” window, which can be launched from various menus within the NMS. The appropriate Audit Entity IDs will appear in the window, based on the menu from which it was launched.

Running an audit will check the configuration of the Audit Entity to determine potential problems with that entity’s configuration, and generate a report detailing those identified problems. The problems are categorized as follows:

- Errors - These are problems in the configuration that are incorrect and can cause the failure of features.
- Warnings - These are for potential problems that may not be what the user intended
- Informational - These generally include parameters collected from the audit that provide the user with a snapshot of the current configuration.

6.21.1 Network VLANs

The sample Diagnostic Audit screen below was launched from the background menu on the VLAN Map associated with Network VLAN ID “Vlan[52]”. In this example, only the Errors and Warnings categories have been selected for the report.

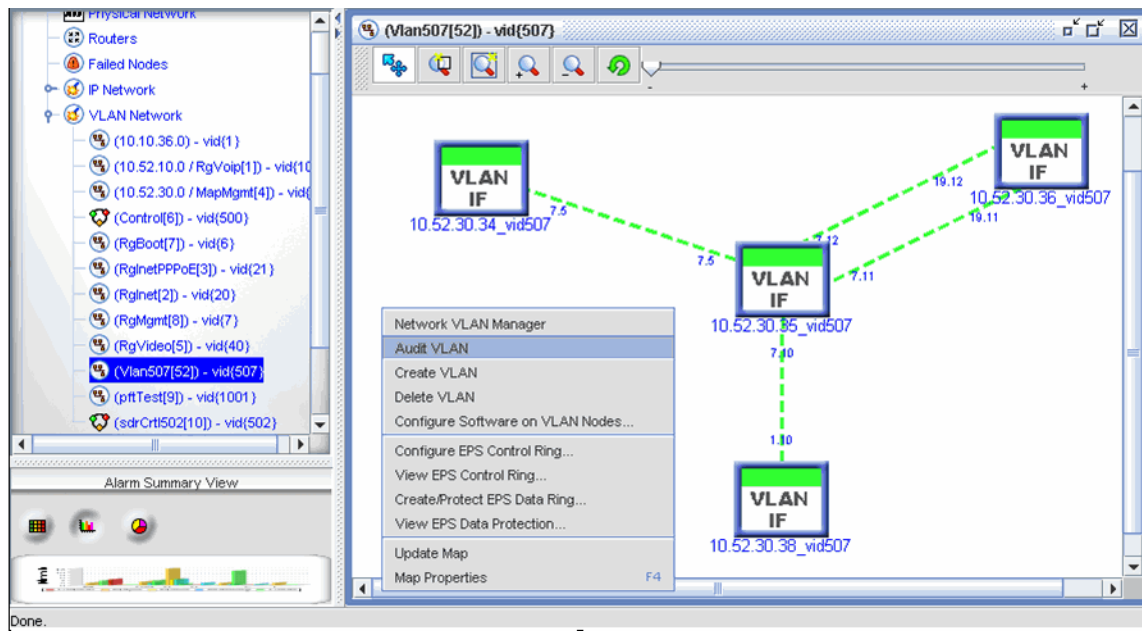

FIGURE 6-245 Audit Selection for Network VLAN

Selecting the Audit VLAN menu item brings up the Diagnostic Audit screen with the selected VLAN, as shown in the following figure.

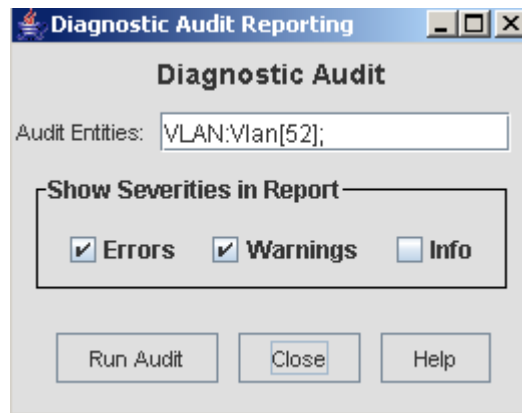

FIGURE 6-246 Diagnostic Audit Panel

The Run Audit button starts the audit and resulted in the following audit report.

Diagnostic Audit Report -- Mon Dec 10 16:48:55 EST 2007

Diagnostic Audit Report

Audit Time: Mon Dec 10 16:48:55 EST 2007, Suppressed Severities: [INFO]

Entity	Problem Type	Problem Description
10.52.30.35	DUPLICATE_TRAPS	<p>ERROR: Duplicate SNMP Traps are being sent to trap hosts: [10.52.18.89] from device 10.52.30.35.</p> <ul style="list-style-type: none"> ● active_traphosts=[10.52.18.89, 10.52.18.56, 10.52.18.72, 10.52.18.89, 10.52.18.95, 10.52.65.32] ● enabled_communs=[public] ● disabled_communs=[]
10.52.30.38	DUPLICATE_TRAPS	<p>ERROR: Duplicate SNMP Traps are being sent to trap hosts: [10.52.18.58, 10.52.18.89] from device 10.52.30.38.</p> <ul style="list-style-type: none"> ● active_traphosts=[10.52.18.58, 10.52.18.89, 10.52.18.56, 10.52.18.58, 10.52.18.72, 10.52.18.74, 10.52.18.89, 10.52.201.221, 10.52.201.222, 10.52.201.231, 10.52.65.32, 10.52.65.36] ● enabled_communs=[public, private] ● disabled_communs=[]
10.52.30.36	DUPLICATE_TRAPS	<p>ERROR: Duplicate SNMP Traps are being sent to trap hosts: [10.52.18.89] from device 10.52.30.36.</p> <ul style="list-style-type: none"> ● active_traphosts=[10.52.18.89, 10.52.18.56, 10.52.18.72, 10.52.18.89, 10.52.18.95, 10.52.65.32] ● enabled_communs=[public] ● disabled_communs=[]
Vlan507[52]	NON_EPSR_WITH_LOOPS	<p>WARNING: VLAN Vlan507[52] has at least 1 loop, but is not a valid EPS Ring. Make sure that any loops are broken by STP/RSTP/MSTP or some other loop prevention mechanism</p> <ul style="list-style-type: none"> ● nonEpsrVifs=[VLANIF-10.52.30.35-507, VLANIF-10.52.30.34-507, VLANIF-10.52.30.36-507, VLANIF-10.52.30.38-507] ● topologyType=GRAPH_WITH_LOOPS
10.52.30.34	NO_NMS_TRAPHOST	<p>ERROR: The NMS is not a Trap Host for device 10.52.30.34.</p> <ul style="list-style-type: none"> ● enabled_nms_v1_traphost_communs=[] ● enabled_nms_v2c_traphost_communs=[] ● active_traphosts=[10.52.18.72]

Close Help

FIGURE 6-247 Example Audit Report

6.21.2 Audit the CES Circuit on the iMG6x6MOD or CES8 Card

A similar audit capability is provided for CES Circuits. These entities can be launched from the following locations:

- Port Table – Audits the CES circuit on each selected port from the Port Table in the Network Inventory (can select multiple ports from the table)
- iMG/RG Table – Audits the CES circuits on each selected iMG from the iMG/RG Table in the Network Inventory (can select multiple iMGs from the table)
- Card Table – Audits the CES circuits on each selected card from the Card Table in the Network Inventory (can select multiple cards from the table)
- Node Table – Audits the CES circuits on each selected device from the Node Table in the Network Inventory (can select multiple devices from the table)
- Physical Network Map – Audits the CES circuits on each selected device from the Physical Network Map, by right-clicking on the device icon and going to the Network Service sub-menu (can select multiple devices from the map)

A CES Audit will check for configuration problems at both ends of the circuit, if the peer port is also managed by the NMS.

The following figure shows how an audit can be initiated from the pull-down menu in the iMG/RG table.

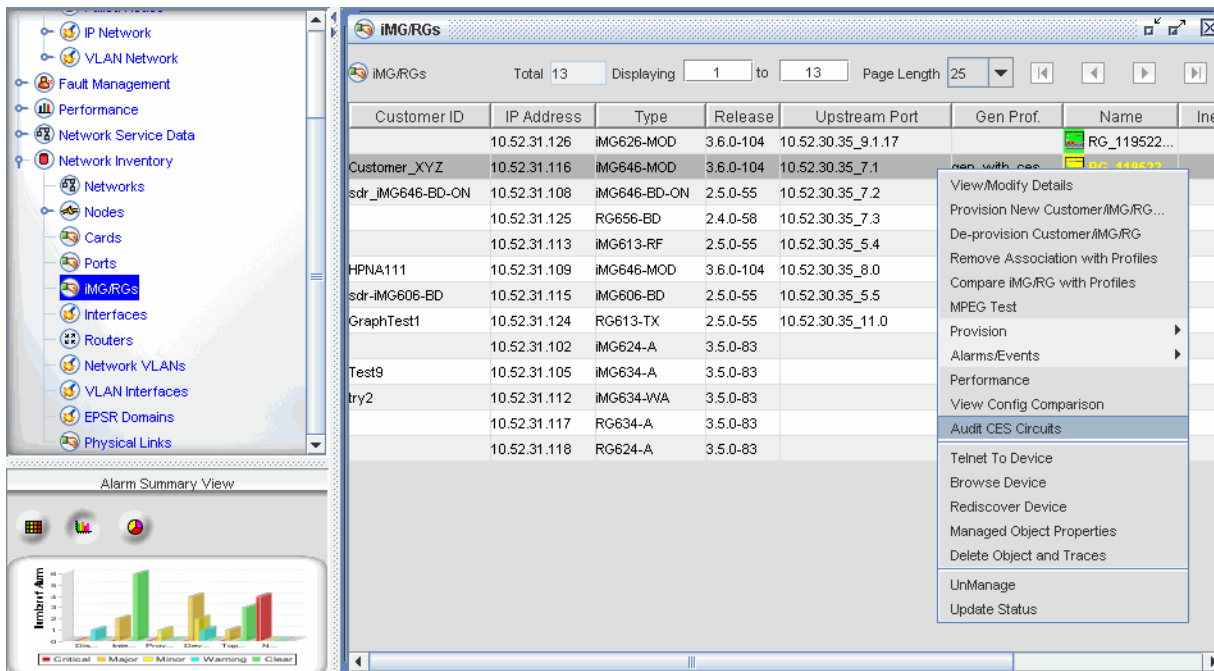

FIGURE 6-248 Accessing the Audit CES Circuit Panel for iMG6x6MOD

After selecting the **Audit CES Circuits** in the pull-down, the Diagnostic Audit panel appears, as shown in the following figure.

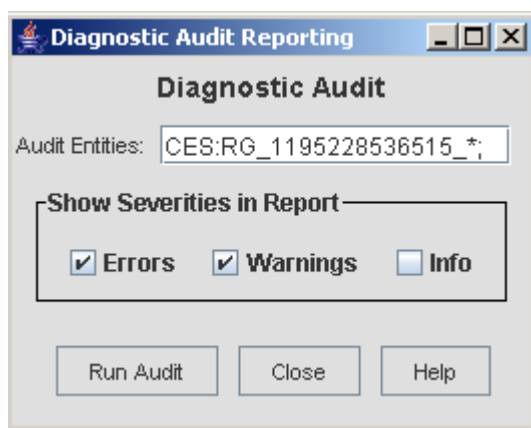

FIGURE 6-249 CES Circuit Audit Panel

The Run Audit button starts the audit and results in the following audit report.

Diagnostic Audit Report -- Thu Nov 29 12:39:34 EST 2007		
Entity	Problem Type	Problem Description
RG_1195228536515_2	STATUS_NOT_CLEAR	<p>WARNING: The Alarm Status of the CES object is not set to CLEAR.</p> <ul style="list-style-type: none"> ◆ customer_id=Customer_XYZ ◆ local_port=RG_1195228536515_2 ◆ local_object_status=Minor ◆ peer_port=10.52.30.36_16.6 ◆ peer_object_status=CLEAR
RG_1195228536515_2	CES_CIRCUIT_DOWN	<p>WARNING: The Provisioned CES Circuit is Down.</p> <ul style="list-style-type: none"> ◆ customer_id=Customer_XYZ ◆ local_port=RG_1195228536515_2 ◆ peer_port=10.52.30.36_16.6 ◆ local_admin_state=Up ◆ local_oper_state=Down ◆ peer_admin_state=Up ◆ peer_oper_state=Down ◆ local_pspan_admin_state=Up ◆ local_pspan_oper_state=Down ◆ peer_pspan_admin_state=UP ◆ peer_pspan_oper_state=DOWND
RG_1195228536515_2	CES_ALARMS	<p>WARNING: The Provisioned CES Circuit has active alarm indications.</p> <ul style="list-style-type: none"> ◆ customer_id=Customer_XYZ ◆ local_port=RG_1195228536515_2 ◆ peer_port=10.52.30.36_16.6 ◆ local_rcv_ais=false ◆ local_port_alarms=LOS ◆ peer_rcv_ais=Unknown ◆ peer_port_alarms= ◆ local_pspan_rcv_ais= ◆ local_pspan_tx_ais=Local Loss of Carrier ◆ local_pspan_alarms=COMM ◆ peer_pspan_rcv_ais=False ◆ peer_pspan_tx_ais=False ◆ peer_pspan_alarms=
RG_1195228536515_1	STATUS_NOT_CLEAR	<p>WARNING: The Alarm Status of the CES object is not set to CLEAR.</p> <ul style="list-style-type: none"> ◆ customer_id=Customer_XYZ ◆ local_port=RG_1195228536515_1 ◆ local_object_status=Minor
RG_1195228536515_1	UNKNOWN_CES_PEER	<p>WARNING: The specified CES Peer endpoint ID "10.10.36.12:50000" of the CES Port RG_1195228536515_1 is unmanaged/unknown to the NMS.</p> <ul style="list-style-type: none"> ◆ customer_id=Customer_XYZ ◆ local_port=RG_1195228536515_1 ◆ local_endpt_id=10.10.10.16:50001 ◆ peer_endpt_id=10.10.36.12:50000

FIGURE 6-250 Results of Running CES Audit

6.22 Port Authentication (802.1x)

The main components of Port Authentication are:

- The Authenticator - the port on the SBx3112 that wishes to enforce authentication before allowing access to services that are accessible behind it. The SBx3112 plays this role.
- The Supplicant -the user device attached to the Authenticator that wishes to access services offered by the authenticator's system. The supplicant may be a PC or other device connected to the Authenticator either directly or via a hub
- The Authentication Server (RADIUS) - a device that uses the authentication credentials supplied by the supplicant (using 802.1X method described below), via the authenticator, or from the authenticator itself (using MAC based authentication method) to determine if the authenticator should grant access to the network. Once authorized, the Authentication server notifies the Authenticator to allow access. The Authentication Server may also supply other information pertaining to the supplicant such as a particular VLAN to use.

Port authentication can be implemented with the following methods:

- 802.1X - This uses the IEEE Standard 802.1X standard. The supplicant is required to use 802.1X and supply the authentication credentials to the Authentication Server via the Authenticator.
- MAC-based authentication - This uses the source MAC address of the supplicant for authentication. When the Authenticator receives the frame from a newly learned source MAC, the Authenticator generates a RADIUS request for authentication.
- Web-based authentication - A username/password pair is entered from the client's browser. When the switch receives the pair, it generates a RADIUS request for authentication.

The Authenticator can be configured to authorize one supplicant or more than one supplicant, as follows:

- Single Host - Only one (single) supplicant that is authorized can be allowed to communicate on the Authenticator port. The other supplicant is disallowed.
- Multi Host - More than one supplicant is possible on the Authenticator port. When any one supplicant succeeds with authentication, the other supplicants are automatically considered to be authenticated and can communicate on the port. This mode is known as 'Piggyback Mode' also.
- Multi Supplicant - More than one supplicant is possible on the Authenticator port. However each supplicant has to be individually authenticated. Some supplicants are allowed and some supplicants may be disallowed when a supplicant failed to authenticate.

In NMS 12.3, the following are supported:

- 802.1x method
- MAC Authentication method
- Single Host, Multi Host, and Multi Supplicant

Note: Configuring RADIUS is not part of NMS provisioning, and must be done separately.

6.22.1 Port Authentication for a Device

Port Authentication Management is added to possible tasks at the device level, as shown in the following figure. (If the menu item appears and the device is not supported, a **Not Supported** window appears.

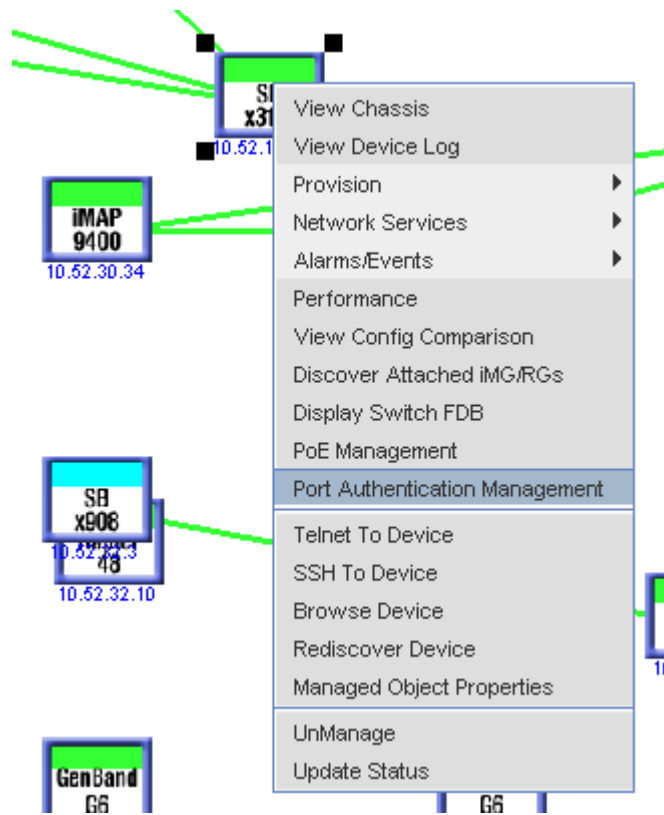

FIGURE 6-251 Port Authentication Management for a Device (From Icon)

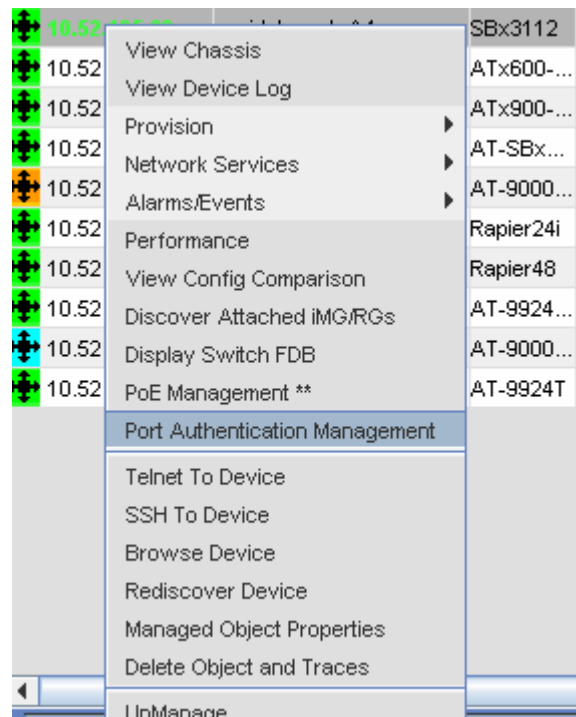

FIGURE 6-252 Port Authentication Management for a Device (From Device Table)

The Port_Auth_Mgmt screen appears, with device information and a set of tabs, one for Port Authentication and one for Radius. Refer to the following figures. Note that for AlliedWare Plus devices, this is a new window in release 12.3.

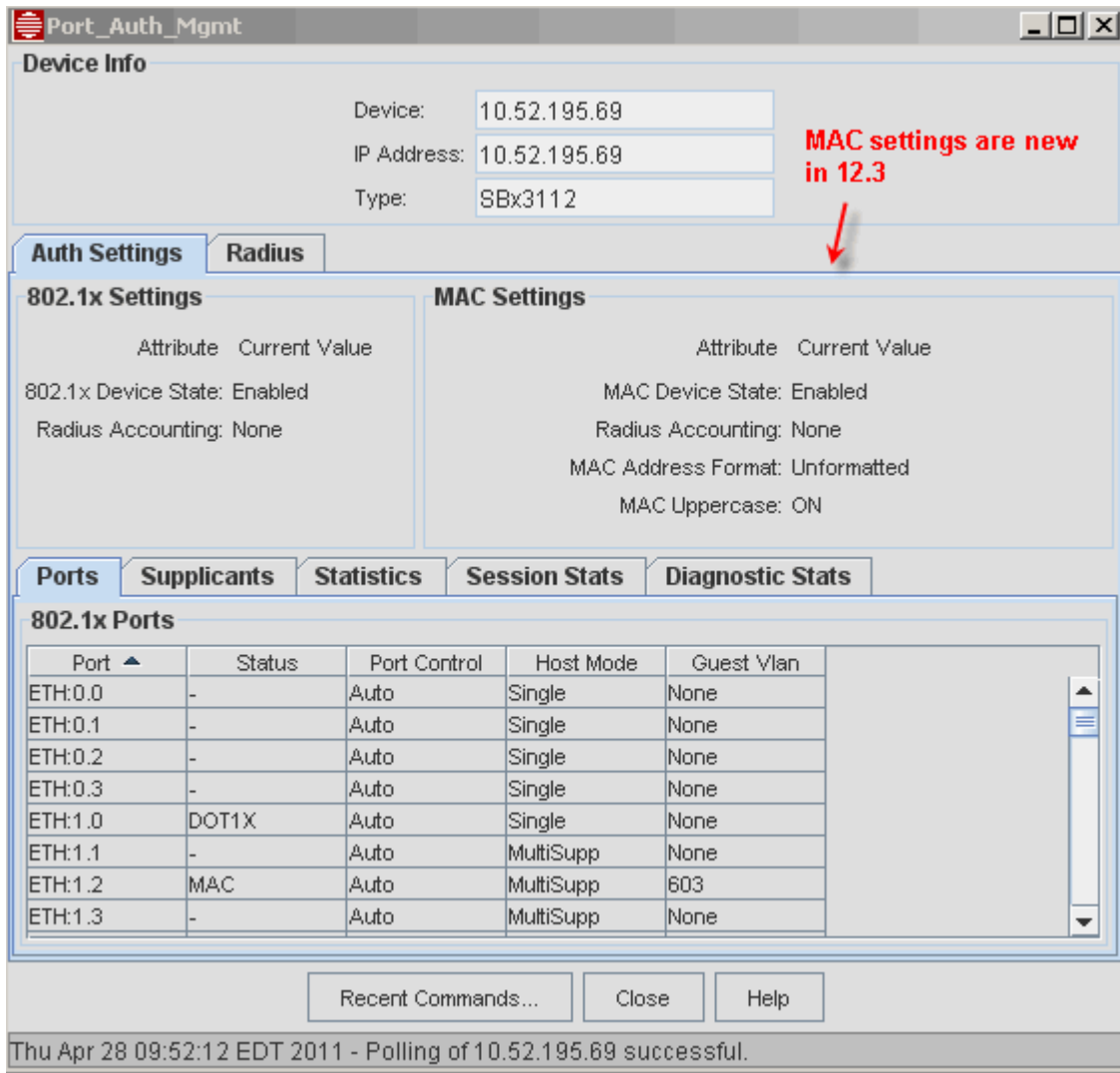

FIGURE 6-253 Port Authentication Configuration - SBx3112 Device

The Auth Settings tab has the following subtabs:

- Ports - The status of Port Authentication (Enabled or Disabled), Port Control, Host Mode, and Guest Vlan.
- Supplicants - The attributes of supplicants that have successfully connected.
- Statistics - For each port the MAC address and counts of 802.1X protocol frames.
- Session Stats - For each port the MAC address and attributes for a completed session.
- Diagnostic Stats

The Radius Tab allows the user to view the RADIUS attributes that have been configured.

For the AlliedwarePlus devices the Port Authentication Management window, there are some differences in the display regarding what data for each port is displayed. Refer to the following figure.

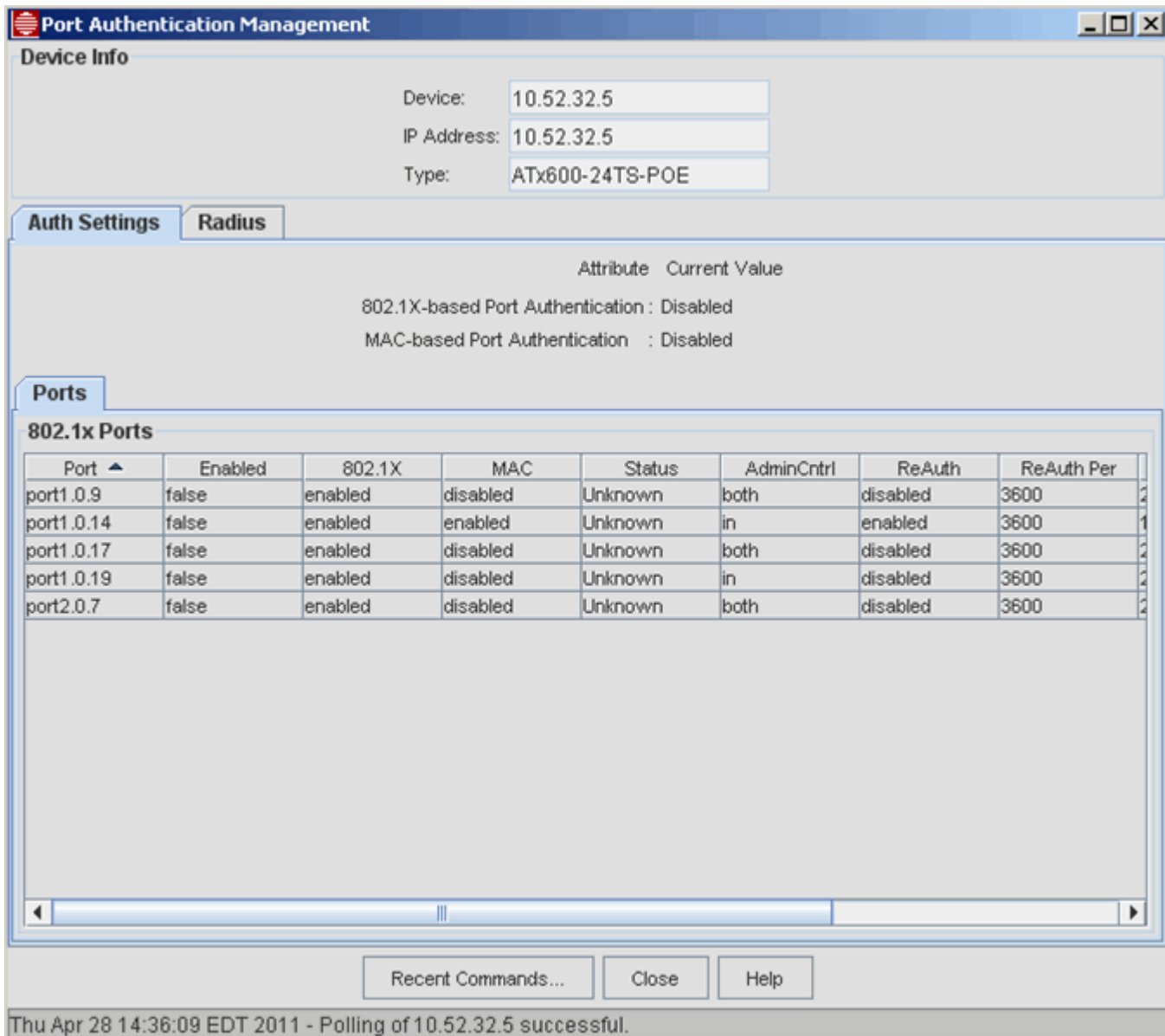

FIGURE 6-254 Port Authentication Configuration - AlliedWare Plus Device

6.22.2 Profiles with the Port Authentication Feature

To configure Port Authentication for a port, the Profiles can be used so that the feature is automatically enabled when the port is brought into service. The following Profiles include Port Authentication.

Note: Although the feature can be changed on the Service Management window for the port, it is recommended to use Profiles and the Triple-Play form to configure the feature, since this will lead to fewer errors when configuring a large number of ports.

6.22.2.1 iMAP (SBx3112) and AlliedWare Plus Device Profiles

The following figure shows the menu to bring up a Profile for an iMAP (in this case, the SBx3100) and AlliedWare Plus devices.

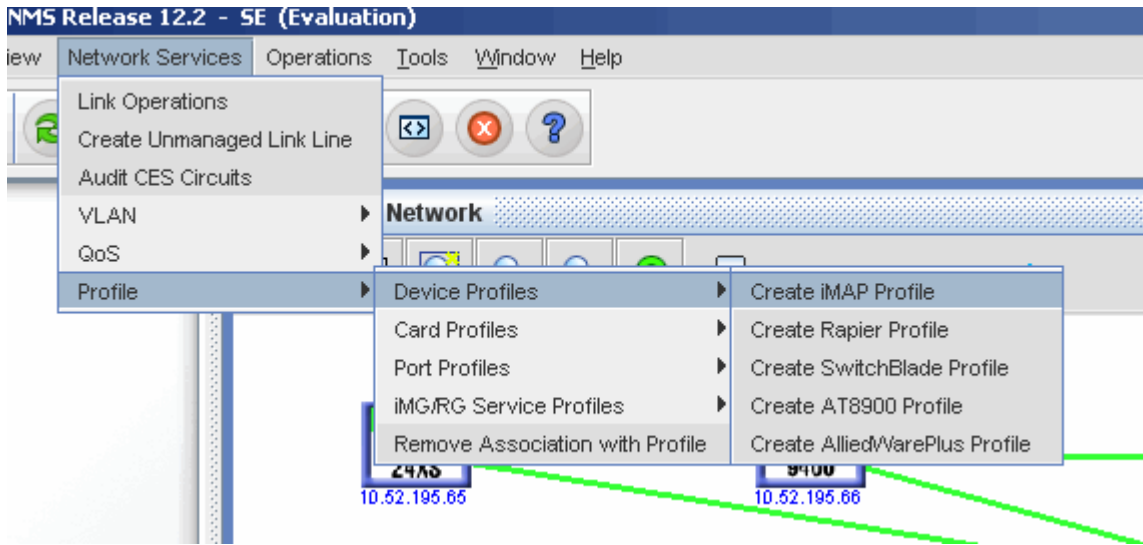

FIGURE 6-255 Profile for Port Authentication for iMAP (SBx3112)

The Profile itself has a Port Authentication tab, with options for 802.1x and MAC Authentication. For AlliedWare Plus devices, there is the added field Radius Group, when a set of Radius servers are combined with a group label. (If there is not a group, the label “Radius” is filled in.) Refer to the following figure.

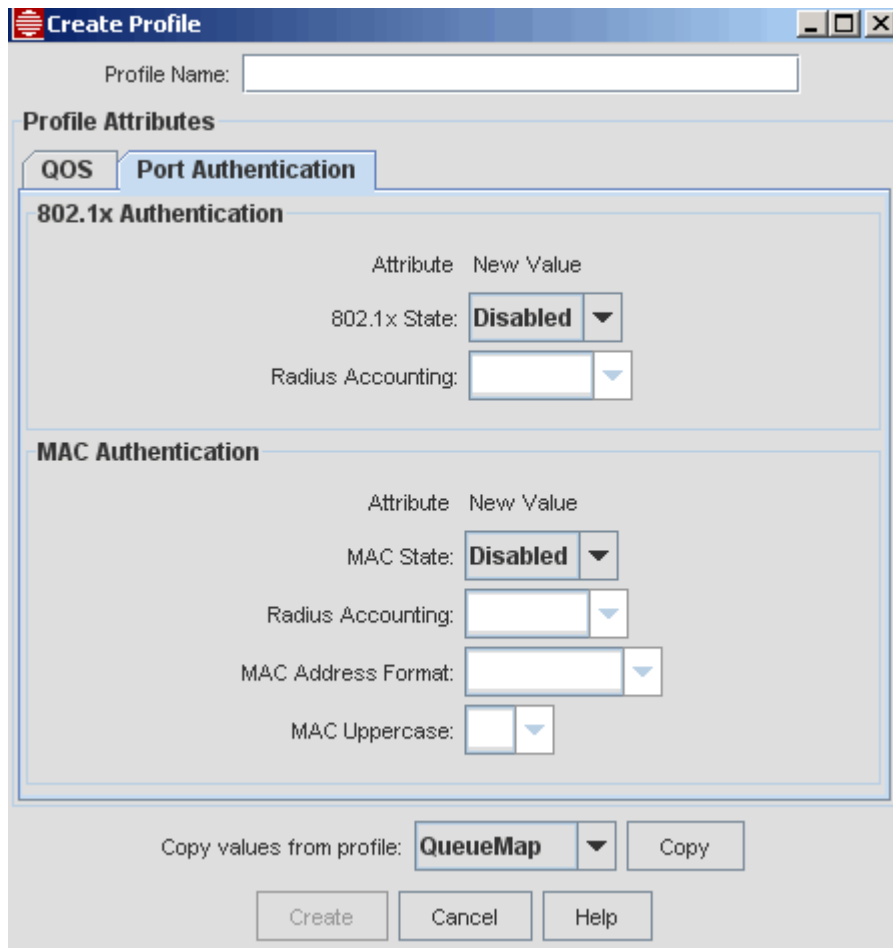

FIGURE 6-256 Profile for Port Authentication - SBx3112 for NMS 12.3 (Includes MAC Authentication)

FIGURE 6-257 Profile for Port Authentication - AlliedWare Plus Devices for NMS 12.3 (Includes MAC Authentication)

6.22.3 Etherlike Port Profile

With this Profile the Port Authentication tab is used, and it provides the attributes needed to activate Port Authentication. (Refer to device specific documents, such as the SBx3112 Software Reference manual, for details on these fields.) Refer to the following figure. Note that there is a panel for MAC-based authentication and that the common Port Authentication settings are grouped that apply to both 802.1x and MAC-based.

The screenshot shows the 'Create Profile' dialog box for an Etherlike Port. The profile name is empty, and the profile type is 'Etherlike Port'. The dialog is divided into several sections:

- Profile Attributes:** Includes tabs for Common, Product Type, STP, POE, and Port Authentication (selected).
- 802.1x Authentication:**
 - 802.1x Auth State: Disabled
 - Control Direction: []
 - EAP Version (1,2): []
 - EAP Max requests to Supplicant (1..10): []
 - Max Re-Authentication Attempts (1..10): []
 - TX Period (1..65535 secs): []
 - Port Control: []
- MAC Authentication:**
 - MAC Auth State: Disabled
 - MAC Auth Method: []
- Authentication Settings:**
 - Dynamic VLAN: EnforceSingle
 - Guest Vlan (None,1..4094): None
 - Host Mode: SingleHost
 - Max Supplicants (2..2048): 2048
 - Reauth Enabled: Off
 - Reauth Period (1..2147483647 secs): 3600
 - Quiet Period (1..65535 secs): 60
 - Server Timeout (1..65535 secs): 30
 - Supplicant Timeout (1..65535 secs): 30

At the bottom, there is a 'Copy values from profile:' dropdown set to '12.0_Eth' and a 'Copy' button. Below that are 'Create', 'Cancel', and 'Help' buttons.

FIGURE 6-258 Profile for Etherlike Port - Port Authentication

6.22.4 Feature Support (AlliedWare Plus and iMAP Devices)

Although much of the functionality is the same between the SBx3112 and the AlliedWare Plus of Port Authentication, there are some settings for the AlliedWare Plus devices that are not included in the configuration settings, as follows:

- Auth-fail – set auth-fail vlan
- Critical – operation in case there is no response from radius server
- Log – configure log message outputs

- Roaming – to be able to move supplicant to other port not re-authentication
- Supplicant Mac – enable port auth specified MAC address
- Keytransmit – transmit 802.1x authentication key

These items are not in the profiles nor in the view/modify screen, as explained below.

For settings that are common between the AlliedWare Plus devices and iMAP devices (the SBx3112), there are some differences in the settings, as listed below.

TABLE 6-28 Port Authorization Parameter Values - SBx3112 and AlliedWare Plus

Parameter	SBx3112 Values	AlliedWare Plus Values	Notes
Dynamic Vlan	None Single EnforceSingle	None Single Multi	Each choice is shown to the user in the profile but it will fail if the wrong setting is sent to that device. In the view modify screen the selection is limited to only the values valid for that device type.
Reauth Period	2147483647 secs	4294967295 secs	The range presented in the profile is the smaller of the two (3112 value). This is also limited in the view/modify. The smaller range is already in years.
Max Supplicants	2...2048	2...1024	The range presented in the profile is the larger of the two. If the range applied to the AWP is above the max then it defaults to the max allowable (1024). In the view modify the correct range is enforced.
Various attributes with "enable/disable" instead of "on/off"			These are set and shown in the client as on/off even though enable or disable is sent in the background.

6.22.5 Implementing Port Authentication with Triple-Play

When Port Authentication for the device is enabled and the Etherlike Port Form is set so 802.1X or MAC-based is enabled, the user can fill out the Triple-Play form and include the Etherlike Port Profile. When the port is placed in service, Port Authentication is enabled, as shown in the Service Management window.

Ether-like Port Management

Device: 10.52.30.39 Port: 11.22

Device Data Collection | Stats Graph | IP Filters | Port Log | POE | **Port Authentication**

General | STP | FDB | Port Statistics | Port Thresholds

802.1x Authentication

Attribute	Current Value	New Value
802.1x Auth State:	Disabled	<input type="text" value=""/>
Control Direction:	In	<input type="text" value=""/>
EAP Version (1,2):	1	<input type="text" value=""/>
EAP Max requests to Supplicant (1..10):	2	<input type="text" value=""/>
Max Re-Authentication Attempts (1..10):	2	<input type="text" value=""/>
TX Period (1..65535 secs):	30	<input type="text" value=""/>
Port Control:	Auto	<input type="text" value=""/>

MAC Authentication

Attribute	Current Value	New Value
MAC Auth State:	Enabled	<input type="text" value=""/>
MAC Auth Method:	EAPMD5	<input type="text" value=""/>

Authentication Settings

Attribute	Current Value	New Value
Dynamic VLAN:	OFF	<input type="text" value=""/>
Guest Vlan (None,1..4094):	None	<input type="text" value=""/>
Host Mode:	MultiSupp	<input type="text" value=""/>
Max Supplicants (2..2048):	2	<input type="text" value=""/>
Reauth Enabled:	OFF	<input type="text" value=""/>
Reauth Period (1..2147483647 secs):	3600	<input type="text" value=""/>
Quiet Period (1..65535 secs):	60	<input type="text" value=""/>
Server Timeout (1..65535 secs):	30	<input type="text" value=""/>
Supplicant Timeout (1..65535 secs):	30	<input type="text" value=""/>

Modify Clear Entry Fields

Recent Commands... Close Help

Wed Aug 03 16:11:56 EDT 2011 - Polling of 10.52.30.39 successful.

FIGURE 6-259 Service Management Form - Port Authentication Active

Note: Once Port Authentication is enabled (by setting to Enabled at both device and port), you cannot add or delete a VLAN on that port. The following type of error is seen in the console window when modifying a VLAN on a port (via view/modify the port or deploy/apply the port profile):

```
delete VLAN=40 interface=1.2
Processing.....
Error (040626) Port Authentication has been enabled on ETH: [1.2]
officer SEC>>
```

To add or delete a VLAN, you must disable Port Authorization (either disable the feature on the port or deprovision the port).

Note: For the SBx3112; you cannot have both 802.1x and MAC Authentication enabled on the same port. Refer to the Software Reference Manual for the SBx3112 for more information.

7. Provisioning the iMG/RG

7.1 Overview

The SE version of this document includes all iMG-related information.

7.1.1 Roadmap for this Section

Use this table as a reference for this Section.

TABLE 7-1 Provisioning the iMG/RG in Release 12.0

Provisioning Component	Section
Network Modeling (Access islands, open Access, Multi-Service VLANs)	7.2.2
iMG/RGs Supported	7.2.3
Provisioning Strategies	7.2.4
DHCP	7.2.5
Remote ID for iMAP device	7.2.6
Customer ID Naming	7.2.7
Viewing provisioned iMG/RG on the AlliedView NMS	7.3
Creating RG Profiles with description of fields	7.4
Example Configurations with Profiles	7.5
Datafilling the Triple Play Form - Examples	7.6
Creating Custom Views with Managed Object Properties	7.7
Using the AlliedView NMS Application Manager	7.8
Provisioning Guidelines for Models	7.9
Installation/Recovery Procedures	7.10
Provisioning the iMG without an iMAP	7.11
Rate Limiting tables	7.17

7.2 Provisioning Strategy

7.2.1 Main Concepts (Profiles, Triple Play Form, DHCP Discovery)

For managing a network, the AlliedView NMS product provides a powerful client that presents the network and its devices in a user-friendly way, allowing its users to learn quickly how the network is configured, how to reconfigure elements when necessary, and how to spot problems (or potential problems) before they degrade network performance.

The Allied Telesis iMG/RG is a product that supports multiple services, and when connected to the AlliedView NMS they can be discovered and monitored, as well as provisioned; using the AlliedView NMS, the network administrator can configure the RG and ensure that the correct (i.e. the most current) software loads are on the RG. This makes administration of the (many) RGs easier to maintain.

The network administrator can follow various provisioning strategies, but all involve the following concepts:

- **Profiles** - A set of profiles is created that provides a set of templates that, when applied, ensure the RG is provisioned for a specific service type with the correct attributes. There are two main profile types:
 - General - These are always associated with an RG regardless of the services offered.
 - Service specific - These are associated with an RG only when a specific service is to be configured.
- **Triple-Play form** - This form, used in previous releases to streamline provisioning of the iMAP port types, is extended to include RG attributes. In most cases the attributes that appear and are data filled are driven by the profiles that are included with the form.
- **DHCP Discovery** - Ensuring the iMG/RG is configured with the correct software and IP address is done as part of the DHCP messaging that takes place between the iMG/RG, DHCP server, and the AlliedView NMS with its tftp server. The series of events during DHCP ensures that the RG is correctly configured and the AlliedView NMS has created an icon of the RG that shows where it is connected to an iMAP system.

7.2.2 Deployment Models (Access Islands, Open Access, multi-service VLANs)

7.2.2.1 Access Islands

Since a large deployment of RGs can involve many business customers and residential subscribers, there is a network hierarchy model that, when used and labeled correctly, can help network administrators set up and track the high number (up to many thousand) of RGs. Refer to the following figure.

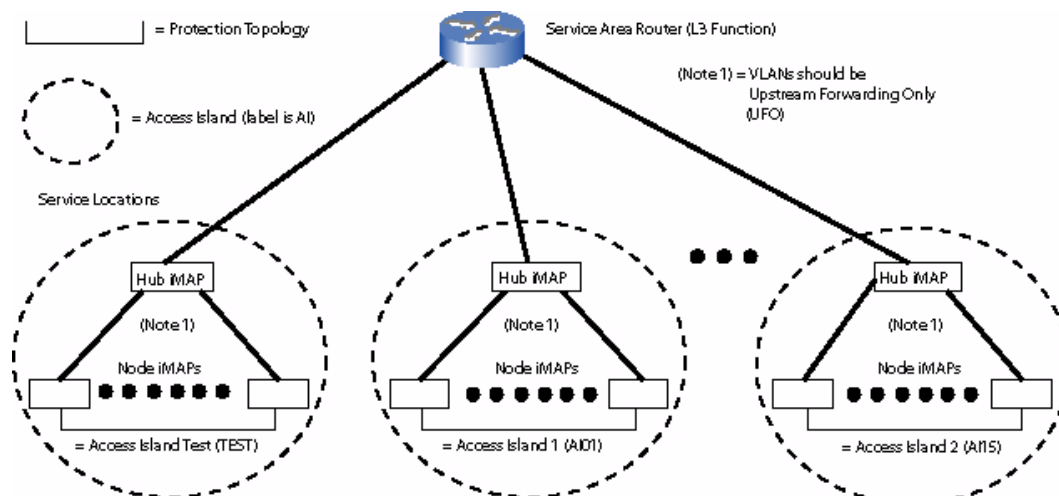

FIGURE 7-1 Network Hierarchy Model for Large Deployment of RGs - Access Islands

For each service provider's wiring center exchange, there can be a Provider Edge-Access Network (PE-AN), and these can be divided into Multi-service **Access Island** Networks. These Access Islands are basically one leaf of the larger network, and can be the initial configuration when a small number of RGs are initially deployed. With growth, a PE-AN could service, for example, 15,000 customers, which each island supporting 1000.

Note: So with this configuration, there can be up to 15 Access Island networks. This concept is used during provisioning.

Usually, one or two GbE or 10GbE Level-3 routers (PE-R) can be used to service the entire PE-AN; with this design the number of anticipated advanced subscriber services will determine the size and capabilities of the required provider edge router.

*Note: Each Access Island uses a set of VLAN numbers unique to that Access Island; the next Access Island uses VLAN numbers that are usually the next number up. For example, Access Island one (AI01) could use a set of VLANs (201, 301, 401, 501, and 601) for DHCP discovery and the subscriber services. The next Access Island would use 202, 302, etc. The exception would be when the PE Router (L3) supports a Virtual Routing Function (VRF) and therefore sufficient multicast routing capabilities. Then each Access Island could have the same VLAN configuration (mirror configuration). **The one-hundred level VLANs (200, 300 etc.) could be for testing with the prefix TEST.***

Note: When provisioning with Profiles for each Access Island, the only Profiles that are unique to each Access Island are the General Profiles, since the General Profile contains the VLAN and L3 static route information. The other Profiles (for service types) are usually the same for RGs in any Access Island since the service offered would have the same attributes.

7.2.2.2 Multiple ISPs (Open Access)

In networks where there are multiple service providers for various services, each VLAN may be used for a service type and ISP. The result is a set of VLANs for each service type, as shown in the following figure.

Refer to 7.9 for details on the multiple ISP configuration.

FIGURE 7-2

Note: The default is the Access Island model.

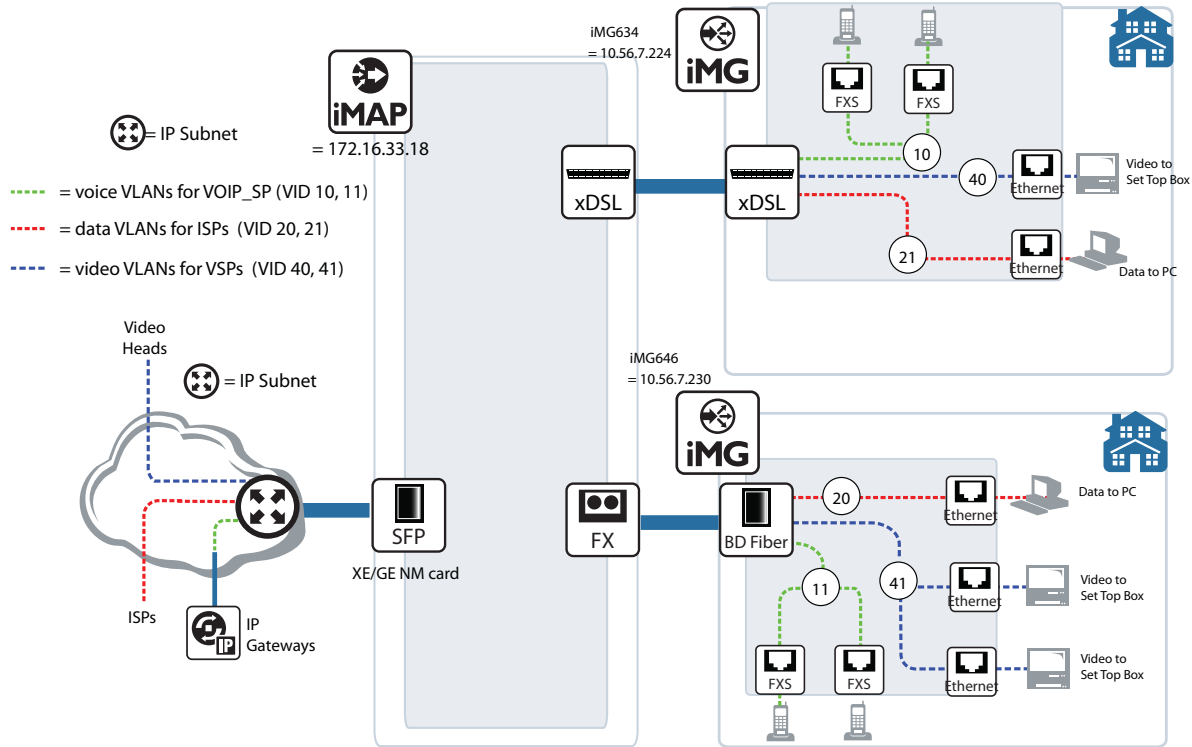

FIGURE 7-3 Multiple ISP Configuration

7.2.2.3 VLANs Providing more than one Service

A VLAN can also be configured to support more than one service. The following figure shows an example of this.

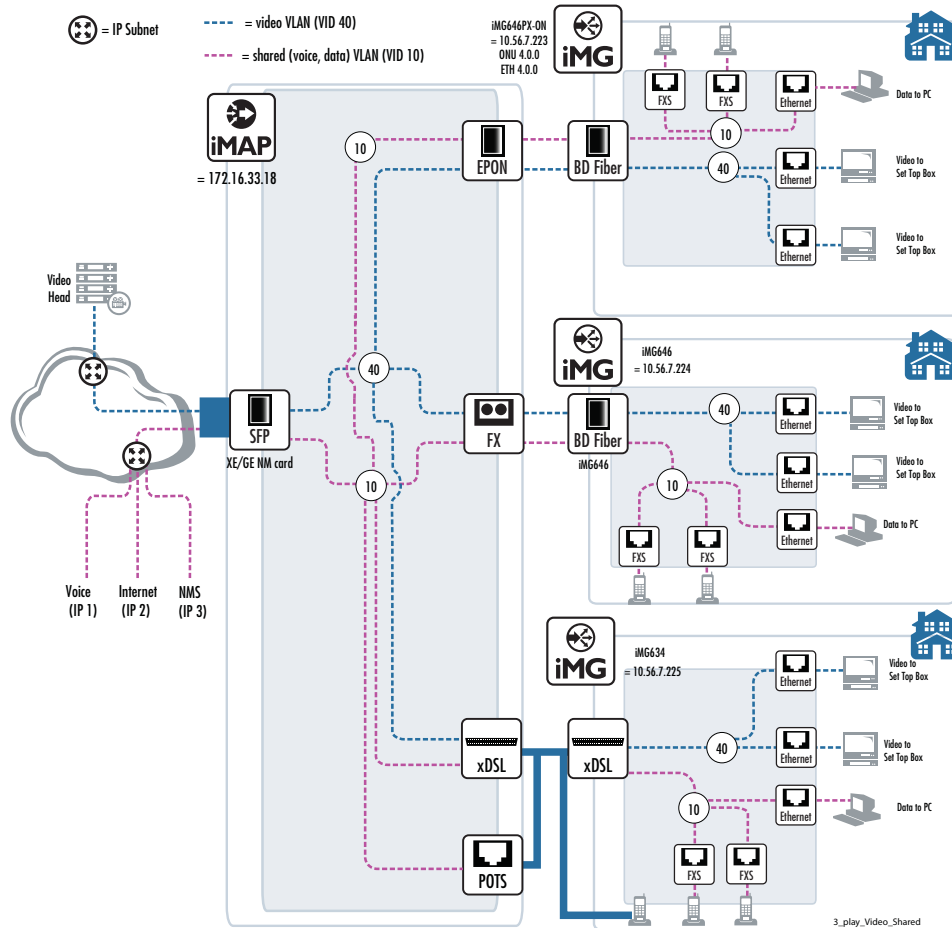

FIGURE 7-4 Multi-service VLAN

In Figure 7-4, one VLAN, 10, provides multiple services, data and voice. The services are separated by the provider (and the AlliedView NMS) using the IP address. The other VLAN, 40, provides video only and so all data packets in the VLAN can be sent to a video provider.

This type of configuration has variations, in which different types of services are on the one shared VLAN, and the service type on the single VLAN can vary. Datafilling this configuration is most easily done using the RG Profile Forms. Refer to 7.10.13.

7.2.2.4 Provisioning the iMG7x6MOD

This type of iMG is highlighted because of the flexibility in provisioning both the WAN and LAN cards. Refer to the following figure.

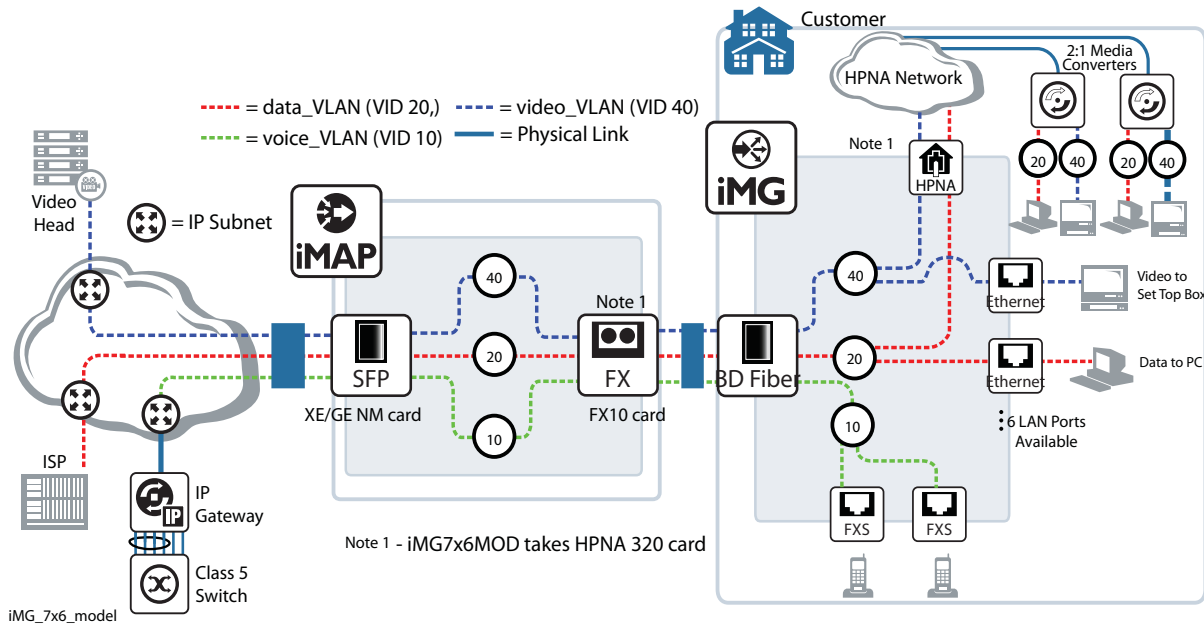

FIGURE 7-5 iMG7x6MOD Configuration

7.2.3 iMG/RG Types Supported

For a list of the iMG/RG devices and what software they support, refer to 1.6.3.

7.2.4 Provisioning Strategies

The main tasks involved in provisioning the iMG/RG are:

1. Setting up the DHCP configuration. This is done on DHCP server(s) and iMAPs, and is done at initial iMAP installation.
2. Creating Profiles. This is done upon initial setup of the iMAPs that participate in the Access Island.

Note: Items 1 and 2 only need to be done once. The remaining tasks are done for each customer using an iMG/RG.

3. Provisioning the Triple Play form
4. Installing the RG
5. Applying power to the RG and waiting for key indicators (lights) for when the RG is configured and running (initial and reboot sequence)
6. Attaching the customer devices
7. Setting up Custom Views to help in viewing the RG configuration.
8. Updating of configuration (usually done through AlliedView NMS applications)

The order of these tasks depends on which overall strategy the network administrator wishes to follow:

1. Fill in the Triple Play form **before** applying power to the RG - With this strategy, the correct configuration of the RG and its connection to the iMAP device happens when power to the RG is applied. These is the step order listed above. **This is the most common sequence for a new customer.**
2. Fill in the Triple Play form **after** the RGs have been plugged in - With this strategy, the RGs are correctly configured as the Triple Play form for each port is filled out and then applied, either immediately or on a schedule.
3. Use the new configuration tasks to re-engineer a previously installed RG. This should always be done when the service “mix” is being changed, and so the relevant Profiles can be associated with the RG. However, even if the services remain the same, using the AlliedView NMS to reconfigure the RG is recommended, since it incorporates the RG into the same configuration as new ones. **It is recommended that existing RG customers use the AlliedView Bootstrap sequence which uses DHCP.**

Note: Although any of these strategies can be used, strategy one is used in the example installation procedures, where the pre-provisioned configuration is downloaded to the RG at the end of the DHCP/discovery process.

7.2.5 Configuring Components for DHCP Discovery

7.2.5.1 Overview

For the RG to be discovered using DHCP, the user must configure the following tools and files correctly.

Note: For the iMG/RGs to use DHCP correctly, all iMAPs must use DHCP Relay, not DHCP Snooping. Refer to the Allied Telesis Software Reference Manual for details on the differences between the two types of DHCP.

Note: For the iMG/RGs to use DHCP correctly, all AlliedWare Plus devices connected directly to iMG/RGs must use DHCP Relay, not DHCP Snooping, which was added in release 5.3.4. Refer to the Allied Telesis Software Reference for AlliedWare Plus™ Operating System for details on the differences between the two types of DHCP.

7.2.5.2 iMG/RG Boot Load Configurator for SNMP and CWMP types

This tool creates bootstrap configurations for the iMG/RG types. The Bootstrap configuration can include:

- firmware
- snmpinit file - defines the device's SNMP communities
- snmpd.cnf file - includes defining the device's trap host
- im.conf file - includes defining the device's management VLAN identifier
- MD5SUM file - used by RGs as a guide to which files need to be downloaded
- cm.bsvlan7t file - This file is used to set up the Mgmt VLAN (the number entered in the Mgmt VLAN ID field) and dhcp using the VLAN to configure the iMG/RG.

The Boot Configurator creates bootstrap configurations for all iMG types which can serve as a uniform starting point for customer provisioning as iMGs are added to a managed network. The configurator then places the bootstrap loads into the NMS TFTP server directory tree, where they are accessible to the TFTP clients (the iMG/RGs).

The files that make up the Bootstrap configuration are downloaded by the iMG via TFTP when the iMG first boots up over the default VLAN. The bootstrap configuration will initialize the iMG's Management VLAN, SNMP settings, and software release.

The tool can only be launched from the NMS server. Navigate to the bin directory under the AlliedView NMS installation directory. Launch the tool with:

- AT_BootConfigurator.bat on **Windows** (or use the load menu and select *Tools -> RG Boot Configurator*)
- AT_BootConfigurator.sh on **Solaris**.

The GUI will appear, as shown below.

Caution: While the tool simplifies the process, it still must be used with caution, since the loads created have to be consistent with the DHCP configuration, which is not, and generally cannot be, integrated into the tool (since it is likely to run on a different host with different security credentials). This tool will create loads with whatever parameters are entered, so the user must be sure the parameters are valid and meaningful. Mistakes can be corrected by repeating the process and overwriting invalid loads.

To include the NextGen iMGs (iMG 1500 and iMG 2500 series), the configurator is organized into separate tabs:

- Summary - Lists the existing configurations. The Release 2 and 3 configurations are grouped as SNMP types and the Release 4 configurations are grouped as CWMP types. The Refresh button, which is only enabled on the Summary tab, will refresh the display and add any new configurations created. The Close button exits the program
- The Release 2 and 3 tabs are identical to the Boot Configuration in previous releases. The only differences are:
 - The Configuration Type drop down list is restricted to the matching release

- The Messages area only displays the processing log. The configuration summary is only displayed in the Summary tab
- The release 4 tab is for the NextGen iMGs

Refer to the following figures and tables.

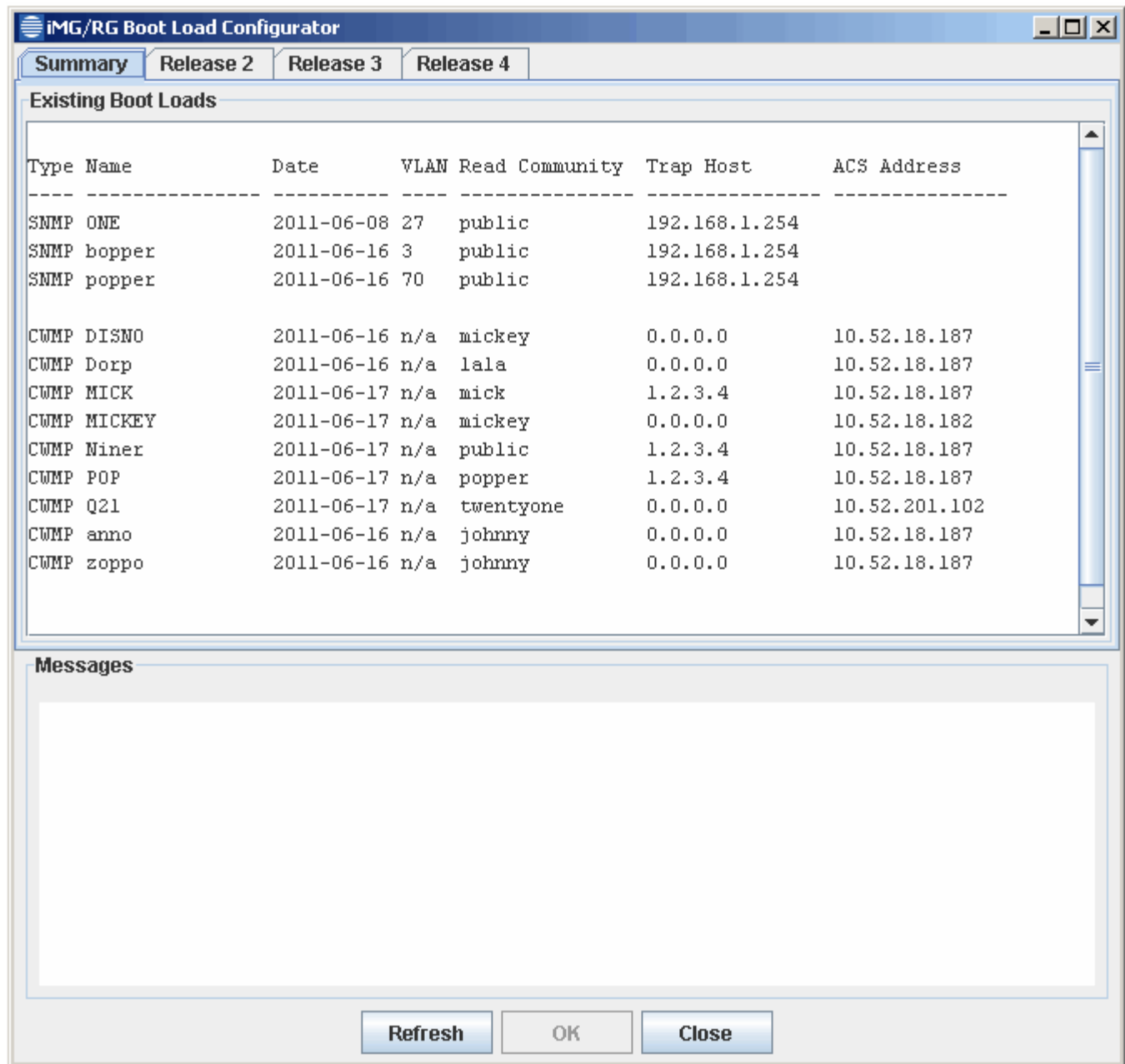

FIGURE 7-6 iMG/RG Boot Configurator - Summary tab

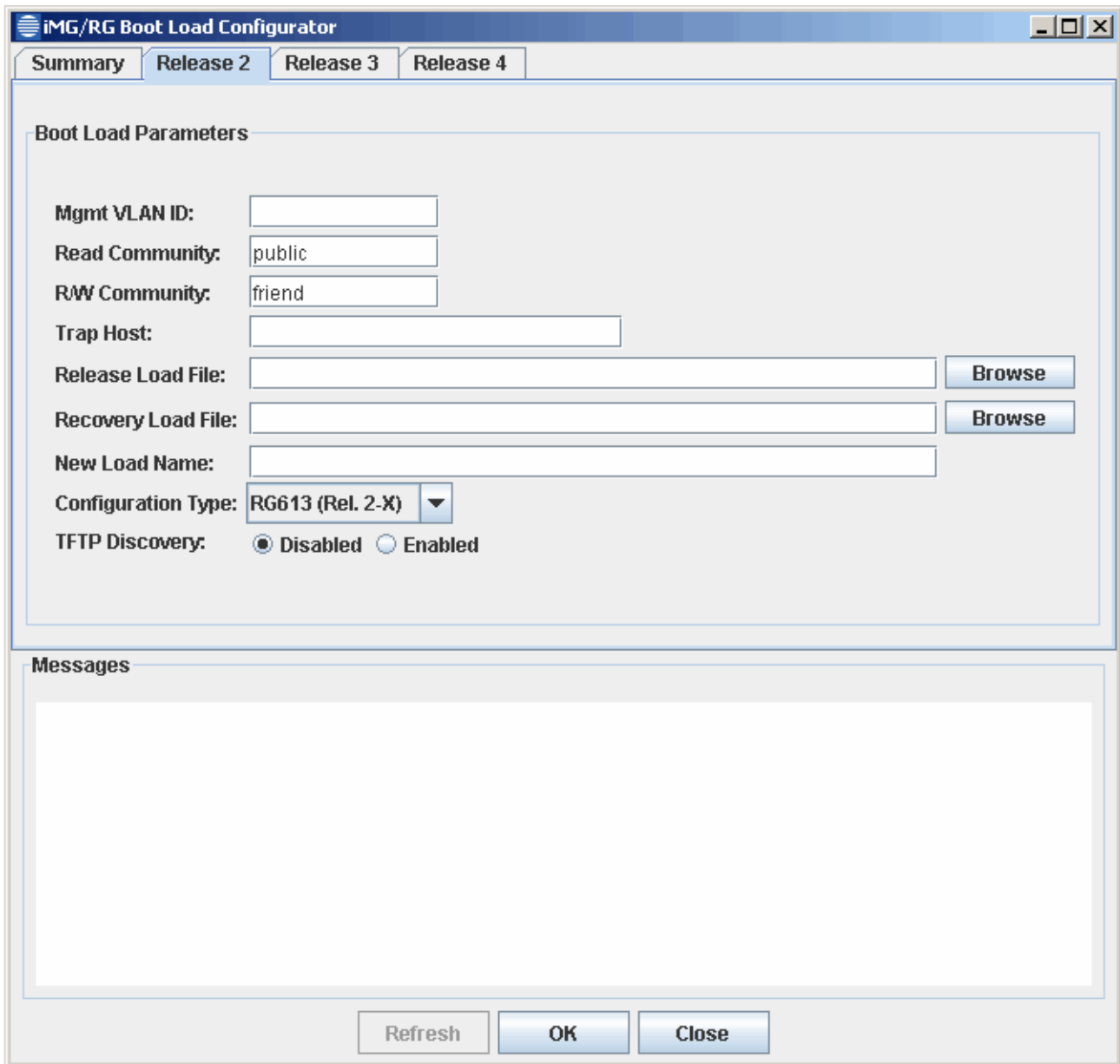

FIGURE 7-7 iMG/RG Boot Load Configurator Tool - Release 2 (and Release 3)

TABLE 7-2 RG/iMG Boot Load Configurator Tool - Release 2 and Release 3 Tabs

Attribute	Value
Mgmt VLAN ID	<p>The VLAN identifier that will be placed into the im.conf file. This is the final RGMgmt vlan which the RG will use while it is in service for a particular customer in a particular access island.</p> <p>(If the same customer moves and takes the RG it will not work if the new residence is not serviced from the same Access Island. The RG must go through bootstrap again and then it will work again.)</p> <p>Note that this can be the same for all Access Islands, as long as the SNMP Community values are the same (see below).</p>
Read Community	<p>the read SNMP community (default public) that will go into snmpinit.</p> <p><i>Note:</i> snmp comm strings for all iMG/RG should be the same for the entire network.</p>
R/W Community	<p>the read/write SNMP community (default friend) that will go into snmpinit.</p> <p><i>Note:</i> snmp comm strings for all iMG/RG should be the same for the entire network.</p>
Trap Host	<p>The SNMP trap host (default none) that will go into snmpd.cnf. This will allow configuring multiple trap destination IP addresses separated by a comma. Multiple IP addresses should only be used when creating boot configuration for devices that support it.</p>
Release Load File	<p>This is the zip file that will be unpacked from the NMS's built-in RG/iMG software repository. The files are named after their releases. The Browse button pops up a file chooser from the software repository. (The path of the software repository will be displayed in the beginning of the Messages window)</p>
Recovery Load File	<p>Another zip file, like the release load file, but contains the recovery software, which will also be unpacked from the software repository.</p>
New Load Name	<p>This is the name of the directory path that will be added to the TFTP server directory to contain the new load. The TFTP root path will be displayed in the beginning of the Messages window. Names should not begin with a slash since these directories will be placed under the TFTP root. Subdirectories relative to the TFTP root can be specified by including slashes in the name. (Forward slashes work on both Windows and Solaris, but backslashes only work on Windows) If the directory already exists, its contents will be overwritten (after user confirmation), which can be used for correcting mistakes. (In the example, for ADSL iMG/RGs the path could be ADSL/AI01.) The load name must match what is in dhcpd.conf (refer to 7.2.5.3).</p>
Configuration Type	<p>This specifies which type of im.conf file to use in the new load. There is a pull-down for devices for the user to select when creating the correct configuration for that release. This is because some of the releases do not use a configuration compatible to other releases of same type.</p>
TFTP Discovery	<p>When selected, after the RG reboots it sends a DHCP discovery message to the DHCP server (over the RGMgmt VLAN). The iMG/RG then sends a tftp request to the NMS, containing its MAC and IP address. The NMS uses its tftp listener to discover the iMG/RG with this IP and MAC Address. With the IP and MAC Address, the AlliedView NMS can proceed with discovery and provisioning.</p>
Load Type	<p>This specifies whether a complete load is to be created or if only SNMP configuration files will be created. SNMP-only can be used for the special case of a one-time SNMP reconfiguration that can be accomplished at the next TFTP restart, which will download only SNMP files and leave the existing release on the device otherwise unchanged. Be sure to select the correct Recovery Load File, which is the source of the basic SNMP configuration to be modified, or else SNMP reconfiguration will fail after the device restarts.</p>

TABLE 7-2 RG/iMG Boot Load Configurator Tool - Release 2 and Release 3 Tabs

Attribute	Value
Messages	Messages show the progress and status of each load creation. The initial messages include the path to the software repository (where the zip files reside), the path to the TFTP server root (where the loads will be placed), and a summary of any existing loads already residing in the TFTP directory tree. All messages should be reviewed carefully per the cautionary note stated above. Errors will be reported here, as well.
Refresh	Only valid for the Summary tab.
OK	The OK button creates the load from the parameters entered and also creates a new MD5SUM file for all the files in the load. After successfully creating one load, additional loads can be creating by editing the parameters and selecting OK repeatedly. Not applicable to the Summary tab.
Close	Exits the tool. All messages from the Messages window will be saved to a log file in the logs directory (logs/boot_configurator.txt). If the log file gets too big, the oldest entries will be deleted from the log. If, for some reason, saving the log should fail, the user will be prompted to exit anyway or not, and will have a chance to at least copy and paste the contents of the Messages window for future reference, if necessary.

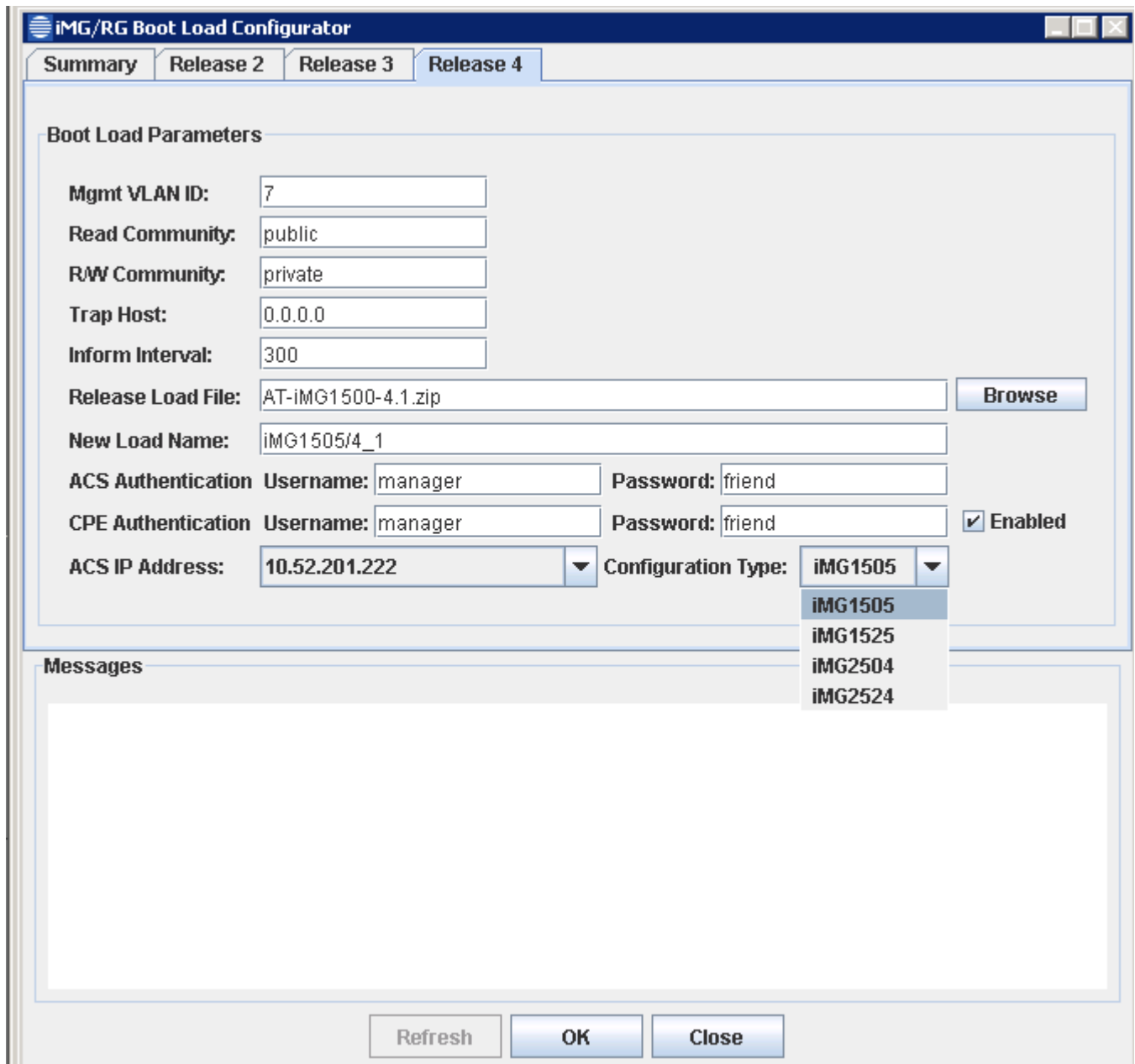

FIGURE 7-8 iMG/RG Boot Load Configurator Tool - Release 4 (NextGen iMG)

TABLE 7-3 RG/iMG Boot Load Configurator Tool - Release 4 Tab

Attribute	Value
Mgmt VLAN ID	The VLAN identifier that will be placed into the im.conf file. This is the final RGMgmt vlan which the RG will use while it is in service for a particular customer in a particular access island. (If the same customer moves and takes the RG it will not work if the new residence is not serviced from the same Access Island. The RG must go through bootstrap again and then it will work again.) Note that this can be the same for all Access Islands, as long as the SNMP Community values are the same (see below).
Read Community	the read SNMP community (default public) that will go into snmpinit. <i>Note:</i> snmp comm strings for all iMG/RG should be the same for the entire network.
R/W Community	the read/write SNMP community (default friend) that will go into snmpinit. <i>Note:</i> snmp comm strings for all iMG/RG should be the same for the entire network.
Trap Host	The SNMP trap host (default none) that will go into snmpd.cnf. This will allow configuring multiple trap destination IP addresses separated by a comma. Multiple IP addresses should only be used when creating boot configuration for devices that support it.
Inform Interval	TR69 inform interval - the interval at which the iMG checks for updates, defaulted to 5 minutes
Release Load File	This is the zip file that will be unpacked from the NMS's built-in RG/iMG software repository. The files are named after their releases. The Browse button pops up a file chooser from the software repository. (The path of the software repository will be displayed in the beginning of the Messages window)
New Load Name	This is the name of the directory path that will be added to the TFTP server directory to contain the new load. The TFTP root path will be displayed in the beginning of the Messages window. Names should not begin with a slash since these directories will be placed under the TFTP root. Subdirectories relative to the TFTP root can be specified by including slashes in the name. (Forward slashes work on both Windows and Solaris, but backslashes only work on Windows) If the directory already exists, its contents will be overwritten (after user confirmation), which can be used for correcting mistakes. (In the example, the path could be iMG1505/4_1.) The load name must match what is in dhcpd.conf (refer to 7.2.5.3)
ACS Authentication	Username and Password iMGs will use to connect to the Auto Configuration Server (ACS).
CPE Authentication	Username and Password ACS will use to connect to iMGs.
ACS IP Address	Normally this is the NMS server IP. If the server has more than one IP, this will be a drop down list.
Configuration Type	This specifies which type of bootstrap file to use in the new load. This is a pull-down for devices for the user to select when creating the correct configuration for that release. This is because some of the releases do not use a configuration compatible to other releases of same type.
Messages	Messages show the progress and status of each load creation. The initial messages include the path to the software repository (where the zip files reside), the path to the TFTP server root (where the loads will be placed), and a summary of any existing loads already residing in the TFTP directory tree. All messages should be reviewed carefully per the cautionary note stated above. Errors will be reported here, as well.
Refresh	Only valid for the Summary tab.

TABLE 7-3 RG/iMG Boot Load Configurator Tool - Release 4 Tab

Attribute	Value
OK	The OK button creates the load from the parameters entered and also creates a new MD5SUM file for all the files in the load. After successfully creating one load, additional loads can be creating by editing the parameters and selecting OK repeatedly. Not applicable to the Summary tab.
Close	Exits the tool. All messages from the Messages window will be saved to a log file in the logs directory (logs/boot_configurator.txt). If the log file gets too big, the oldest entries will be deleted from the log. If, for some reason, saving the log should fail, the user will be prompted to exit anyway or not, and will have a chance to at least copy and paste the contents of the Messages window for future reference, if necessary.

7.2.5.3 DHCP Server File (dhcpd.conf)

On the DHCP server is the file dhcpd.conf, which includes the options associated with the specific VLAN in the DHCP message. Following is a sample.

Note: The global option specifying the tftp server, which needs to be set to the NMS ip address, is: option tftp-server-name.)

Note: Refer to 13.2 (Appendix) for a complete example.

```
#####
# Class for RGBootStrap for Access Island 01 (AI00) #
#####

class "SPSI-AI00-iMG1525Boot" {

match if ((substring(option agent.remote-id,0,9)="SPSI-AI00")# DHCP RemoteID prefix for iMAPs in
AI

and (substring(option agent.circuit-id,2,2)="x00xc8") # VLAN 200 See Note 1

and (option vendor-class-identifier = "iMG1525")); # iMG at Release 4 stream

filename "FIBER/AI00/iMG1525"; #<--Directory structure for type of iMG in AI00

option tftp-server-name "10.52.201.4"; #<--IP address of TFTP Server (NMS)

option vendor-class-identifier "iMG1525";

}

class "SPSI-AI00-RG634ABoot" {

match if ((substring(option agent.remote-id,0,9)="SPSI-AI00")

and (substring (option agent.circuit-id,2,2)="x00xc8")

and (option vendor-class-identifier="RG634A")); # iMG at Release 3 stream

filename "ADSL/AI00/RG634"; #<--Directory structure for type of iMG in AI00

option tftp-server-name "10.52.201.4"; #<--IP address of TFTP Server (NMS)

option vendor-class-identifier "RG634A";

}
```

Note 1: The VLAN VID is in decimal and the value in the DHCP server in this example must be in HEX, i.e.:

- 200 = C8 for TEST, so string is "\x00\xC8"
- 201 = C9 for AI01, so string is "\x00\xC9"

- 300 = 12C for TEST, so string is "\x01\x2C"
- 301 = 12D for AI01, so string is "\x01\x2D"

- 400 = 190 for TEST, so string is "\x01\x90"
- 401 = 191 for AI01, so string is "\x01\x91"

- 500 = 1F4 for TEST, so string is "\x01\xF4"
- 501 = 1F5 for AI01, so string is "\x01\xF5"

- 600 = 258 for TEST, so string is "\x02\x58"
- 601 = 259 for AI01, so string is "\x02\x59"

You need a class defined for all the iMG/RG types expected/planned to be used in each Access Island in the network. Following are some examples. (For a complete list refer to the *iMG/RG Software Reference Manual*, Preface.)

- RG613TX
- RG613SH
- RG613LH
- RG613BD
- iMG646BD
- iMG606BD
- iMG646BD-ON
- iMG646PX-ON
- RG656BD
- RG624A
- RG634A
- RG624B
- RG634B

The above example shows that when the message comes in over VLAN 200 (usually the bootstrap VLAN for the RG for this Access Island), there is a pointer to the tftp IP address and a bootstrap filename. If the message comes in over VLAN 300 (RGMgmt), there is no pointer to the tftp IP address with no bootstrap file name.

7.2.5.4 DHCP Relay Configured on the iMAPs (VLAN Configuration)

The DHCP Relay configuration in the iMAP associated with the RG must be data filled so that DHCP instances match the correct IP address for the DHCP server and are associated with the correct VLAN.

The iMAP should be provisioned with at least two DHCP relay instances where data service VLANs (like RGBootstrap, RGVoice, Video, Internet VLANs) are in one relay instance (e.g. **MAIN**) and the management VLAN (e.g. RGMgmt) is in the second instance (called for example **MGMT**). Each of these instances should be configured to relay to the specific service provider’s operational DHCP server(s) supporting option 82. The second DHCP relay instance (MGMT) will be configured to copy to the AlliedView NMS tftp server as well as to the service providers operational DHCP server(s) supporting option 82.

Note: It is good practice to have one DHCP Relay instance for each service, as well as one for MGMT. Refer to the second example.

Following is the example for **MAIN**.

DHCP Instance Name	Mode	Remote ID	Servers
MAIN	RELAY	SPSI-AI00-MN1X71	10.10.10.1 *(dhcpsvr1)

This MAIN relay instance provides relay service for the example VLANs:

- RGBootstrap - 201
- RGVoice - 601
- Internet - 401 (non-UFO)
- InternetUFO - 451 - **In most cases the service VLANs should be UFO.**
- Video - 501

Following is the example for **MGMT**.

DHCP Instance Name	Mode	Remote ID	Servers
MGMT	RELAY	SPSI-AI01-MN1X71	10.10.10.2 *(dhcpsvr2) 10.10.11.1 *(NMS)

This MGMT relay instance provides relay service for the example VLAN:

- RGMgmt - 301 - Note that **the RGMgmt VLAN must have its own instance.**

Note: TLS services should not have DHCP relay enabled for the customer’s VPN TLS VLAN. Also, the QoS policy should use classifiers/filters to allow and remark packets appropriately.

Following is an example with one Relay instance per service.

DHCP Instance Information

DHCP Instance Name	Mode	CID Format	Shelf ID	Remote ID	VLAN Vid list
MAIN	RELAY	AUTO	00:0C:25:1F:80:10	00:0C:25:1F:80:10	None
RGBoot	RELAY	AUTO	00:0C:25:1F:80:10	SPSI-AI00-MAP5x4	200
RGMgmt	RELAY	AUTO	00:0C:25:1F:80:10	SPSI-AI00-MAP5x4	300
RGVoice	RELAY	AUTO	00:0C:25:1F:80:10	SPSI-AI00-MAP5x4	400
Internet	RELAY	AUTO	00:0C:25:1F:80:10	SPSI-AI00-MAP5x4	600
Video	RELAY	AUTO	00:0C:25:1F:80:10	SPSI-AI00-MAP5x4	500

The iMAP should be provisioned with a unique DHCP “Remote ID” so that the DHCP server can clearly identify where DHCP messages are coming from. Refer to 7.2.6 for an overview of naming conventions that should be followed so that administrators can easily label and configure the iMG/RG configuration.

Caution: *Ensure that DHCP Relay is enabled on the iMAP network (upstream) interfaces, as well as the interfaces to the iMG/RG. Otherwise, DHCP will not work.*

Note: *For each Access Island, a unique RGMgmt VLAN and subnet must be provided. All DHCP-related configurations for each Access Island are placed in separate configuration files. Since each file must declare shared networks, all iMAPs (relay agents) that are in the same Access Island must be declared in the same configuration file. (Includes are supported by dhdpd configuration.) Refer to the Appendix for an example.*

7.2.5.5 DHCP Relay Configured on the AlliedWare Plus Devices (VLAN Configuration)

The DHCP Relay configuration in the AW+ devices associated with the RG must be data filled so that the DHCP/VLAN configuration matches the correct IP address for the tftp server and is associated with the correct VLAN.

Here is an example of the config required for dhcp relay on aw+ for the service, rgboot, and rgmgmt vlans:

```
interface vlan201                                     //rgboot
ip address 10.52.110.177/28
ip dhcp-relay agent-option
ip dhcp-relay information policy replace
ip dhcp-relay server-address 10.52.201.36
!
interface vlan301                                     //rgmgmt
ip address 10.52.110.193/28
ip dhcp-relay agent-option
ip dhcp-relay information policy replace
ip dhcp-relay server-address 10.52.201.36
ip dhcp-relay server-address 10.52.201.4
!
interface vlan401                                     //rgvoice
ip address 10.52.110.209/28
ip dhcp-relay agent-option
ip dhcp-relay information policy replace
ip dhcp-relay server-address 10.52.201.36
!
interface vlan501                                     //video
ip address 10.52.110.225/28
ip igmp
ip igmp querier-timeout 1
ip igmp query-max-response-time 1
ip igmp query-interval 25
ip igmp version 2
no ip igmp source-address-check
```



```

ip pim dr-priority 100
ip pim sparse-mode passive
ip dhcp-relay agent-option
ip dhcp-relay information policy replace
ip dhcp-relay server-address 10.52.201.36
!
interface vlan601                                //internet
ip address 10.52.110.241/28
ip dhcp-relay agent-option
ip dhcp-relay information policy replace
ip dhcp-relay server-address 10.52.201.36
!
    
```

Note: Customers on each switch must be in non-shared subnets, because the AlliedWare Plus devices do standard DHCP Relay with option 82 as circuit ID only (no remote ID) and do not perform DHCP Snooping.

7.2.5.6 Summary of Steps for iMG Provisioning

The following table summarizes the steps needed for iMG provisioning for the iMG types and the upstream devices.

TABLE 7-4 Summary of iMG Provisioning

Discovery Method	iMG Type	Upstream Device	Steps
DHCP	TR69 (i.e. iMG 1525)	Allied Telesis	
DHCP	TR69 (i.e. iMG 1525)	non-Allied Telesis	
DHCP	non-TR69	Allied Telesis	
DHCP	non-TR69	non-Allied Telesis	
TFTP	non-TR69	non-Allied Telesis	

7.2.6 Naming Conventions to Identify Components (DNS)

7.2.6.1 Overview

The DNS naming conventions for components are extremely important for administrators because they help in allowing services to be delivered to subscribers within a specific Access Island.

Note: When dynamic DNS services are required (as in the case of the G6) the voice DHCP server must be separate from the rgboot/rgmgmt. The DNS servers can be on separate servers or they can coexist on DHCP servers.

For the iMAPs, the remoteID is used as part of the DNS name, and it follows a very specific naming convention, as explained in 7.2.6.2. The DNS server will **scope** on the first set of digits (depending on the naming convention used) of the remote-ID, which identifies a specific Access Island. This, along with the VLAN IDs and Vendor-Class ID, determine which layer 3 subnets should be used for a specific subscriber. This is explained in detail in 7.2.6.2.

For all of the iMG/RGs within a specific voice subnet, there must be a DNS entry with a structured name. When configured correctly (for the DNS servers and the AlliedView NMS Profiles) the AlliedView NMS correctly coordinates the voice components so that voice service works correctly. This is explained in detail in 7.2.6.4.

Note: Before beginning the configuration of iMGs/RGs, the naming system should be planned out, and then set up in the DNS or a local host file.

Note: You must add RGMgmt subnets to discovered and managed subnets before any devices can be discovered on these subnets.

7.2.6.2 DNS Entries for Allied Telesis Components (iMAPs)

The naming of the iMAPs identifies the Service Area (the Access Island) and how it maps to service locations. Each iMAP component includes an identification ID (remoteID in the DHCP instance) that includes this Service Area, Service Location, and Access Island number. It then includes the specific iMAP. Table 7-5 explains this naming, with the result as follows:

- The Service Area is SPSI
- The specific Access Island the component is part of is included as well (AI1 for Access Island 1)

All components use this prefix as part of their ID and are used for DNS naming.

Note: Refer to for character usage rules.

TABLE 7-5 Recommended Naming Convention for Remote ID of iMAP for DHCP

Attribute	Value
CCCCSS-AInn-LLnTTnn	General format for Remote ID (See below)
CCCC	4 character name for the serving area
SS-	2 character name for the state the serving area is located in. A dash at the end helps to identify the Access Island, which is next in the string. This is optional.
AInn-	The Access Island that this device belongs in, so AI01 1 would be Access Island 1. For a test Access Island, a 00 or T instead of a number would be used. Note there is a dash (-) after the Access Island. This allows the user to more easily discern the digits that identify the Access Island These make up the 10-digit prefix that identifies the Access Island. Also, this is used to scope Profiles, explained later.

TABLE 7-5 Recommended Naming Convention for Remote ID of iMAP for DHCP

Attribute	Value
nnnn....	Characters that help identify the device and any attributes for its location, type, etc.
Examples	iMAP 1 9700 = SPSI-AI00-MAP1x7 iMAP 2 9400 = SPSI-AI00-MAP2x4 iMAP 5 9810 = SPSI-AI00-MAP5x8 x3112 NCSU = SPSI-AI00-x3112-NCSU

With the domain suffix of “**ai.corp.int**”:

The fully qualified name for the first iMAP would be:

SPSI-AI00-MAP1x7.ai.corp.int

The following table summarizes the naming convention and can be used as a reference.

TABLE 7-6 Reference for Remote ID

Description	4 character name for the serving area	2 character name for the state the serving area is located in.	Access Island that this device belongs in, separated by a dash. ¹	Characters used to identify the device and any attributes that are significant.
Example Values	SPSI	NA	-AI00- -AI01- -AIT- (test)	MAP1x7

1. Use one dash on each side to help in reading the string. this part of the string. **Do not use double dashes or spaces in the string.**

7.2.6.3 Character Usage Rules

- Character allowed are letters, numbers, single dashes (-), and periods (.).
- Do not use a double dash, such as when you need a placeholder. Instead, use a string such as -X-.
- Do not use spaces, underscores, colons, or other special characters.

7.2.6.4 Dynamic DNS Naming for Voice Subnets

For voice service, there must be a Dynamic DNS entry for all RGs in the voice subnet. Moreover, each entry must have a specific structured name (Fully Qualified Domain Name, or FQDN) so that all related components can communicate with each other and be aware when changes are made. The format of the FQDN is as follows:

rgvoip-<MAC address>.domain

This is part of the DHCP discovery process, and its success depends on the components that make up voice service being configured and pre-provisioned correctly. This is explained in detail in 7.2.6.6

7.2.6.5 Detailed steps for DHCP Discovery

Refer to Figure 7-9 for the first four steps for DHCP discovery.

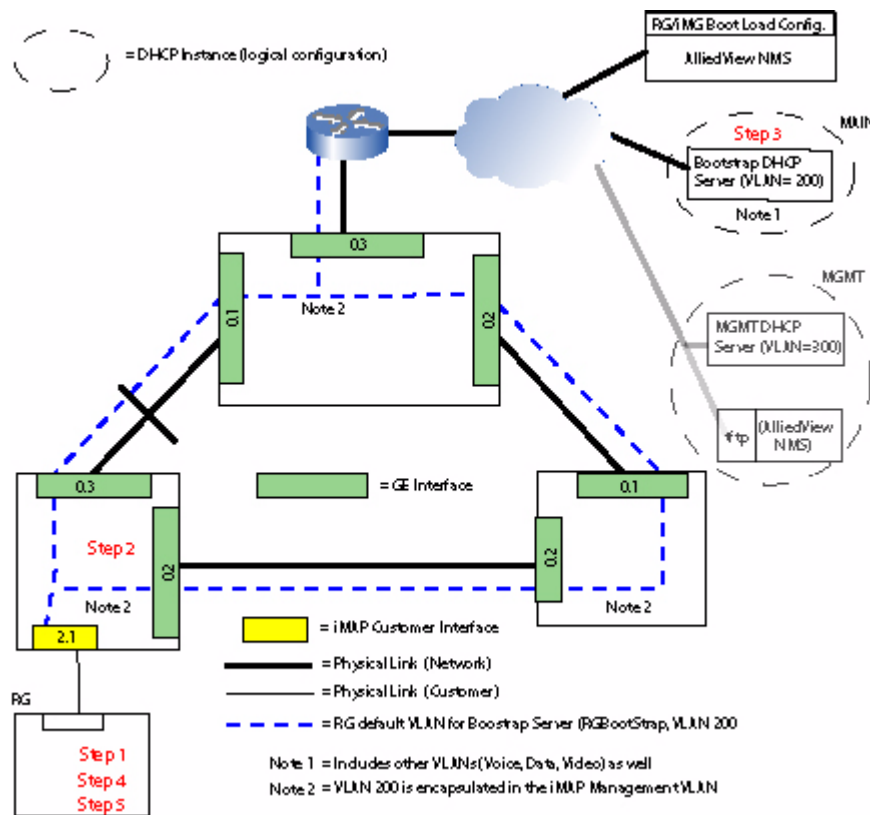

FIGURE 7-9 DHCP Discovery - Bootstrap VLAN

1. The RG powers up and sends a DHCP discover message over the untagged VLAN for its port.
2. The iMAP adds the Remote ID, slot.port, and VID information to the circuit ID and forwards the DHCP discover message to the DHCP server over the inband iMAP Management interface. (Neither the RG nor the end user devices need unicast access to the DHCP server as the iMAP is the proxy relay for them.)

Note: The iMAP is configured with DHCP Relay so that it sends DHCP messages to both Server and Listener along with the circuit ID attributes.

3. The DHCP server classifies the Discovery and then sends a DHCP offer message with the free IP address allocated for the RG bootstrap, including a mask, the boot directory, the gateway, the vendor class ID, and the tftp server address of the AlliedView NMS. (As noted, the DHCP server has been configured to know the tftp address.)
4. The RG requests the MD5SUM file from the tftp server, and compares the checksum of its files versus those in the MD5SUM (with its list of files and checksum). The RG performs a GET on any files that differ, as well as the im.conf file that sets up the RGMgmt VLAN using DHCP. (The system light is 4 Hz red while downloading, 2 Hz red while writing to FLASH, steady green when correctly loaded.)

Note: The recovery code is updated first if needed. (*.rec), then the RG reboots and starts again. Then as needed the main image code and basic "bootstrap" configs elements for the given access island are loaded.

5. The RG reboots and makes a DHCP discover message to the DHCP server, but this time over the RGMgmt VLAN.

Note: When an RG is de-provisioned and removed from the server (when customer moves) the RG must be set back to factory. This can be done using the console "sys conf set factory" command or the tic box on the Deprovision Ports form.

Refer to Figure 7-10 for the next steps for DHCP discovery.

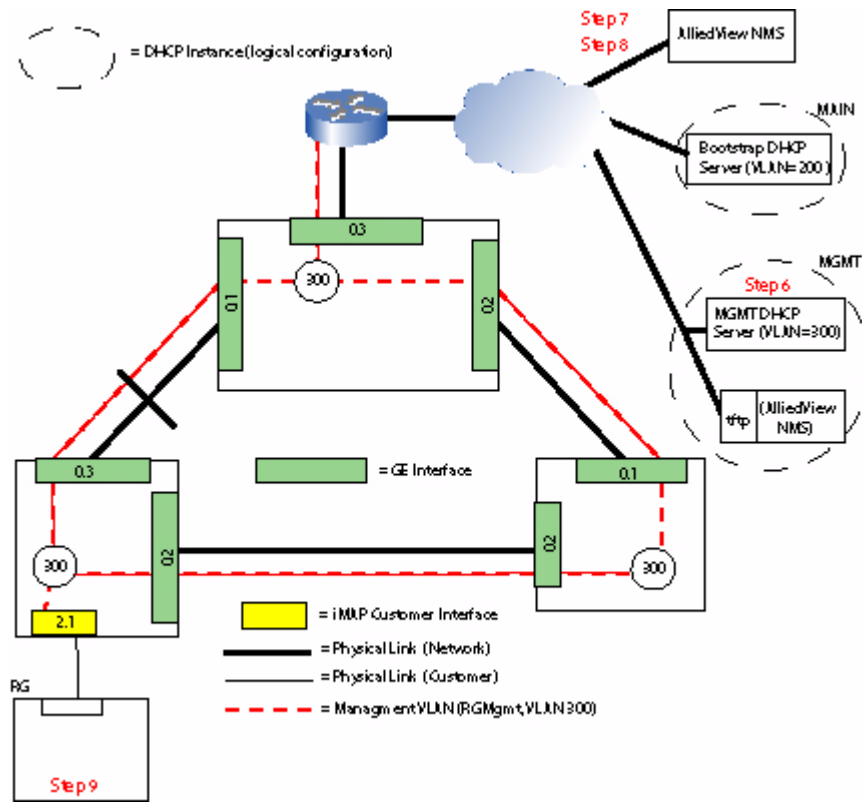

FIGURE 7-10 DHCP Discovery - Management VLAN

6. The DHCP server provides the new IP address.
7. The AlliedView NMS uses DHCP Listener to discover the RG (its IP, and Circuit ID attributes such as MAC) in the RGMgmt VLAN.
8. The AlliedView NMS telnets to the RG, and using CLI it configures the RG and saves this to FLASH on the RG.
9. The user should then connect the LAN devices.

Note: At this point, the RG can provide service if it has been already been pre-provisioned using the Triple Play Customer form. (This form is made easy to fill out if iMG/RG and port profiles have already been defined.) This information is then downloaded to the device and so service can begin. The user has the option, however, to not pre-provision the Triple Play customer form. In this case, the RG is not ready to provide service; the user fills out the form and puts the RG into service once the form is filled out and applied.

Once the AlliedView NMS has this information, it can create an iMG/RG icon on the AlliedView NMS. Note that the RG is not included on the Physical Map, but in the RG’s subnetwork. The RG is also placed in the Network Inventory view under iMG/RGs, and includes the slot.port of its upstream iMAP.

Note: The Management IP address of the discovered iMG/RG is listed on the Network Inventory table. If the iMG/RG sends traps with a source IP address which is not the Management IP address, the resulting alarm will display this IP source and it may not be able to be mapped to the iMG/RG.

7.2.6.6 Discovering Voice Subnets (GenBand, MGC Protocol)

When the voice components are provisioned correctly, all components that are part of VoIP communicate with each other so that dial tone comes up when the RG is plugged in and configured for voice. Moreover, the configuration dynamically updates itself, as IP addresses for voice are renewed/changed for the RG. (The user should be able to swap the RG, and after all components are discovered, the RG can communicate with the voice subnet and dial tone is re-established.)

Refer to the following figure, which shows what must be configured and how the process works.

Before VoIP can work, the following must have already been done, **or voice service will not work**:

1. Profiles have been filled out correctly to support voice service. In particular, in the Voice profile for the RG, the voice domain name must be filled out, and the voice VLAN that is filled in for the RG General profile has already been created. Also, the route to the Genband must be filled out in the RG General Profile if the Genband is on a separate subnet.
2. The Genband (G6, G2) has been provisioned to support voice (Line Profile, Interface Group, CRV)
3. The GenBand has the routing information for the RG; moreover, the routing table in the GenBand must use the BBI interface.
4. On the Triple Play form, the Genband (G6, G2) information for the GenBand (in Step 2) has been filled in for the customer.
5. There is Dynamic DNS (DDNS) between the DHCP server(s) and the DNS server (usually one is reserved only for voice). This is needed since the DNS tables, which correlate the RG's voice IP interface address with the domain name, are updated dynamically.

Note: The Genband/RG configuration can be statically configured, but this is very difficult to maintain administratively since the IP addresses must be tracked/changed manually.

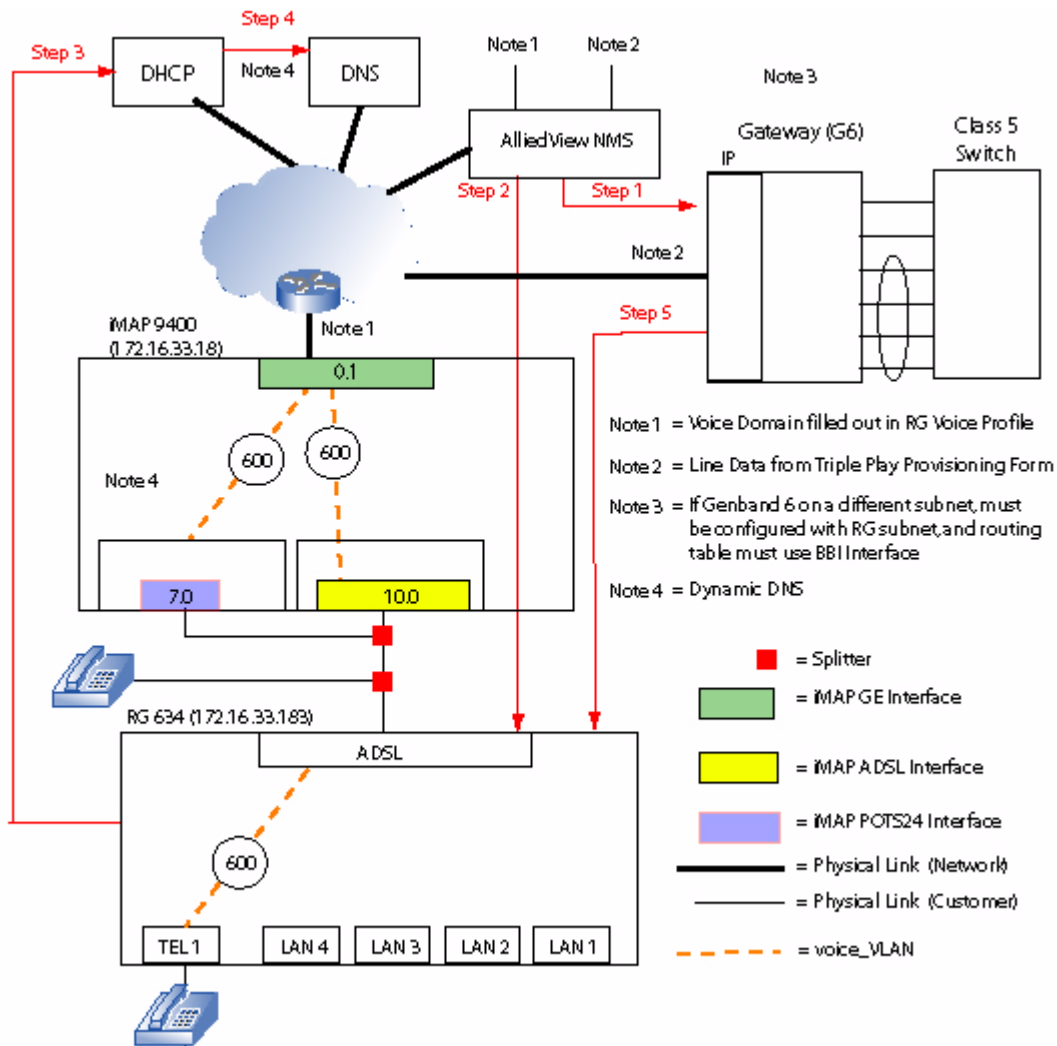

FIGURE 7-11 Voice Service Configuration

When all of the prerequisite steps have been performed and the RG is plugged in, the following occurs:

1. The AlliedView NMS puts together the FQDN for the RG voice interface (i.e. rgvoip-<MAC addr.>.domain) and the port of the iMAP (as <ip addr of connected iMAP>_slot.port). The AlliedView NMS also adds the line entries that were filled out in the Triple-Play form.
2. The AlliedView NMS configures each voice line that has been set up for the RG (creates the voice VLAN, creates the voice IP interface, enables DHCP)
3. The RG sends a DHCP discover to the DHCP server. After an exchange of DHCP messages, the DHCP server has the MAC address (sent by the RG) and the IP address (assigned by the DHCP server) associated.
4. The DHCP updates the DNS server to include the DNS entry between the RG's voice IP interface (the rgvoip string) and actual IP address.
5. The MGCP protocol is run between the GenBand and the RG, and the result is dial tone.

7.2.7 Naming Convention for Customer IDs (Triple Play Form)

Customer IDs have the following attributes:

- Up to 31 characters in length
- Must be unique so they can identify each customer
- Cannot have wild cards (*)
- Cannot contain the word "error" or "Error".
- Cannot contain a question mark (?), backslashes (\), double quote (") or single quote (')
- # is allowed

The naming system for customers is entirely up to the administrator, but should reflect one or more of these:

- Specific attributes that identify a customer
- Service mix
- Common attributes when customers form a logical group

Some example IDs could have the format:

- firstname_lastname_phonenumber
- name_servicemix
- name_grouplabel

Note: This is where a unique prefix (x.) or suffix (_test) would create an easy way to group employees that will participate in ongoing tests but are spread out in many AIs around the network

Note: When providing voice service using the G6 (or G2) product, the G6 will drop any characters in the Customer ID after the 20th character. As a result, any customer ID in which the first 20 characters are the same will not be seen as different by the G6. Although customer IDs longer than 20 can be datafilled there will be the following consequences for the provisioned voice lines if the first twenty characters of the Customer IDs are the same:

- In the Voice Configuration tab of Triple Play Service Management Window, there will be an MGC tab for each voice line that has the identical 20 first characters.

- On the Deprovision Ports Form, multiple voice lines would appear if their associated Customer IDs have the same first twenty characters, and so the administrator would have to know through other attributes the actual voice line(s) to delete.

7.2.8 Changing Customer IDs

Once a Customer ID has been entered using the Triple Play form, it is automatically propagated to the iMG and port-type information, as well as Voice Configuration if the iMG/RG has been configured for voice.

To change the customerID, the administrator must change the customerID for all three types; this is done by changing the CustomerID for all three areas on the Triple-Play Service Management form.

Refer to 6.15.4 and 7.10.10.

7.3 Viewing iMG/RG on the AlliedView NMS

Once the iMG/RGs have been provisioned, they can be viewed in various ways that allow the administrator to track their configuration and their status.

Figure 7-12 shows the physical node, with the iMAPs grouped according to their Access Island. Note the following:

- The IDs of the iMAPs follow the naming convention explained in 7.2.6.
- The iMAPs are grouped to show their physical configuration (hub node, ring, links)

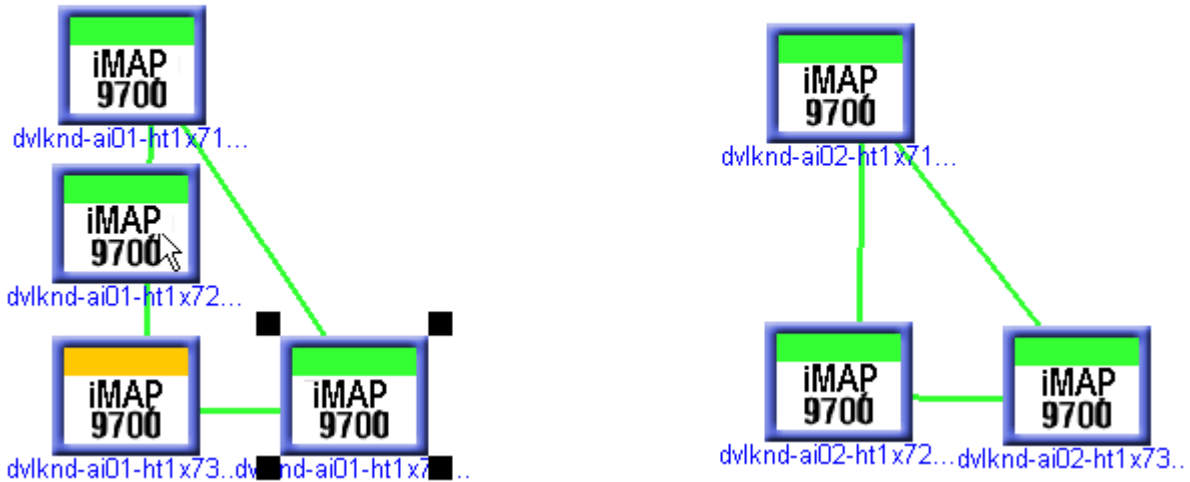

FIGURE 7-12 Physical View - Access Islands

Figure 7-13 shows the RG Inventory List sorted by Upstream port, so the user can easily find specific RG. The table can be sorted by different columns, and the user can create a Custom View to show only specific RGs. (Refer to 7.7.3.)

Customer ID	N...	Upstream Port ▲	Type	IP Address	Release	Gen Prof.	Video Prof.	Inet Prof.	Voice Prof.
		..10.1.4.5_0_2	RG624-A	10.37.17.65	3.2.0-33				
		..10.1.4.5_0_2	RG624-A	192.168.252.254					
Harris Saele		..10.1.5.5_0_0	RG624-A	10.100.0.238	3.3.0-61	DVLK-RG634-IT	Video-3_STBs	InternetBridged	
Mike Miller		..10.1.5.5_3_0	RG634-A	10.100.0.243	3.3.0-61	DVLK-RG634-IT	Video-3_STBs	InternetBridged	Voice-2_Phones
DVLK-HT01-01		..dvlknd-ai01-ht1x71_map_0_0	iMG646-BD	10.56.7.254	2.3.0-59	DVLK-AI01-Advantage	Video-3_STBs	InternetBridged	Voice-4_Phones
Triple_Play_Test_0		..dvlknd-ai01-ht1x71_map_5_0	iMG646-BD	10.56.6.255	2.3.0-59	DVLK-AI01-Advantage*	Video-3_STBs	InternetBridged	Voice-4_Phones
Triple_Play_Test_1		..dvlknd-ai01-ht1x71_map_5_1	iMG646-BD	10.56.7.253	2.3.0-59	DVLK-AI01-Advantage	Video-3_STBs	InternetBridged	Voice-4_Phones
Triple_Play_Test_2		..dvlknd-ai01-ht1x71_map_5_2	iMG646-BD	10.56.6.254	2.3.0-59	DVLK-AI01-DataOnly		InternetBridged	Voice-4_Phones
Triple_Play_Test_3		..dvlknd-ai01-ht1x71_map_5_3	iMG646-BD	10.56.7.252	2.3.0-59	DVLK-AI01-Economy	Video-3_STBs_SNOOP	InternetBridged	Voice-4_Phones
Triple_Play_Test_4		..dvlknd-ai01-ht1x71_map_5_4	iMG646-BD	10.56.5.255	2.3.0-59	DVLK-AI01-Advantage	Video-5_STBs	InternetBridged	Voice-4_Phones
Triple_Play_Test_5		..dvlknd-ai01-ht1x71_map_5_5	iMG646-BD	10.56.6.253	2.3.0-59	DVLK-AI01-Advantage	Video-5_STBs	InternetBridged	Voice-4_Phones
Triple_Play_Test_6		..dvlknd-ai01-ht1x71_map_5_6	iMG646-BD	10.56.7.250	2.3.0-59	DVLK-AI01-Plus	Video-3_STBs_SNOOP	InternetBridged	Voice-4_Phones
Triple_Play_Test_7		..dvlknd-ai01-ht1x71_map_5_7	iMG646-BD	10.56.6.252	2.3.0-59	DVLK-AI01-Plus	Video-3_STBs_SNOOP	InternetBridged	Voice-4_Phones
Triple_Play_Test_8		..dvlknd-ai01-ht1x71_map_5_8	iMG646-BD	10.56.5.254	2.3.0-59	DVLK-AI01-DataOnly		InternetBridged	Voice-4_Phones
Triple_Play_Test_9		..dvlknd-ai01-ht1x71_map_5_9	iMG646-BD	10.56.7.251	2.3.0-59	DVLK-AI01-Advantage	Video-3_STBs_SNOOP	InternetBridged	Voice-4_Phones
DVLKND-HT1-AI02-0.0		..dvlknd-ai02-ht1x71_map_0_0	RG600Family	0.0.0.0					
Stellick 2		..dvlknd-test-hq1x72_map_21_5	RG613-BD	10.56.3.253	2.3.0-59	DVLK-TEST-Economy*	Video-3_STBs*	InternetBridged	Voice-4_Phones
Test Number 2		..dvlknd-test-hq1x72_map_21_7	iMG646-BD	10.56.1.255	2.3.0-59	DVLK-TEST-Economy*	Video-3_STBs*	InternetBridged	Voice-4_Phones
New ADSL on 7.1		..dvlknd-test-hq1x72_map_7_1	RG634-A	10.56.3.251	3.3.0-61	DVLK-TEST-Economy*	Video-3_STBs	InternetBridged	Voice-2_Phones
TestADSL RG2_1		..dvlknd-test-hq1x72_map_7_5	RG624-A	10.56.2.254	3.3.0-61	DVLK-TEST-Economy*	Video-3_STBs	InternetBridged	
George Adsl 7.6		..dvlknd-test-hq1x72_map_7_6	RG634-A	10.56.2.253	3.3.0-61	DVLK-TEST-Economy	Video-3_STBs	InternetBridged	Voice-2_Phones
Mark Stein		..dvlkndaia1-mn1x71_map_0_1	RG634-A	10.100.0.248	3.3.0-61	DVLK-RG634-IT	Video-4_STBs	InternetBridged	Voice-2_Phones
Alex Moen		..dvlkndaia1-mn1x71_map_0_3	RG634-A	10.100.0.240	3.3.0-61	DVLK-RG634-IT	Video-3_STBs	InternetBridged	Voice-2_Phones
NDTC IT Test port 0.5		..dvlkndaia1-mn1x71_map_0_5	RG634-A	10.100.0.244	3.3.0-61	DVLK-RG634-IT*	Video-5_STBs	InternetBridged	Voice-2_Phones

FIGURE 7-13 iMG/RG Inventory View Sorted by Upstream Port

7.4 Creating RG Profiles with Field Descriptions

7.4.1 Overview

7.4.1.1 Pre-requisite Steps

Before Profiles can be created, the administrator has already done the following:

- The DHCP servers and DNS servers have been set up
- Routing has been set up
- The G6 setup and if required with the IP address of BBI and AI's default router IP for voice subnet
- Knowledge of the “back office” management subnets
- Knowledge of the vpn “back office” management subnet

Note: These “back office” subnets are separate subnets that ensure that it is possible to communicate with the RG. These require separate routes as well. Refer to 7.4.2.

- The service VLANs have been set up on the relevant iMAPs.
- Set of RG Profile names that will be used. For General RG Profiles the following shows the naming convention.

For Access Island 1 (AI01)

- SPSI-AI00-P_1I_1V (Phone, 1 Internet, 1 video)
- SPSI-AI00-P_1I_2V (Phone, 1 Internet, 2 video)

For Access Island 1:

- SPSI-AI00_1I_2V (1 Internet, 2 video)
- SPSI-AI00_1I_3V (1 Internet, 3 video)
- etc....

Note: Because rate limiting may be a factor the name may need to highlight this as well.

Note: “Packaged” marketing terms may also be appropriate names here, such as “DVLK-AI01-DSLPro+VVid”

7.4.1.2 Profile Fields and Provisioning Models

As the fields for the RG forms are described, there are notes and further details when the data fill is particularly important for a configuration type (Access Island, Open Access, Multi-service VLAN, Security, etc.)

7.4.2 General Profile

The RG General Profile contains the high level attributes for the RG so that it can support a set of services (data, video, voice). The names that are given to the profiles should match the service set that the RG is supporting.

Note: For each service, there is a separate profile that defines the specific attributes for that service.

To create a General profile, select *Network Services -> Profile -> Create RG General Port Profile*. The **Create Profile Form** will appear with the fields that apply for the RG General Profile. Refer to the following figures and tables.

Profile Attributes

Mgmt. Info | Wireless | Port Assignment | IP Routes

Attribute New Value

Profile Scoping: NDVLKND-AI01

iMG/RG Bootstrap VLAN Id (1..4094 or None): 201

iMG/RG Mgmt VLAN Id (1..4094): 301

Include Service VLANs in Profile: **True** ← **If true, Access Island Model**

iMG/RG Internet VLAN Id (2..4094 or None): 401

iMG/RG Video VLAN Id (2..4094 or None): 501

iMG/RG Voice VLAN Id (2..4094 or None): 601

FIGURE 7-14 RG General Profile - Mgmt Info

Create Profile Profile Name: Profile Type: RG General

Profile Attributes

Mgmt. Info | Wireless | Port Assignment | IP Routes

Attribute New Value

Profile Scoping: Loop Detection:

iMG/RG Bootstrap VLAN ID (1..4094 or None): Persist SNTP Server (IP Addr. or None):

iMG/RG Mgmt VC/VLAN ID (2..4094): Daylight Saving:

Include Service VLANs in Profile: Time Zone:

iMG/RG Internet VC/VLAN ID (2..4094 or None): Limited User Login (login or None):

iMG/RG Video VC/VLAN ID (2..4094 or None): New Limited User Password:

iMG/RG Voice VC/VLAN ID (2..4094 or None): New Manager Password:

iMG/RG CES VC/VLAN ID (2..4094 or None): Super User Login (login or None):

iMG/RG Additional VLAN IDs: New Super User Password:

System Power Management: Split Management:

Subscriber User Login: admin
New Subscriber User Password: admin

Mgmt. Subnets

Name	Subnet Addr.	Mask	Start Addr.	End Addr.

Copy values from profile:

FIGURE 7-15 RG General Profile - Mgmt. Info Tab

TABLE 7-7 Create RG General Port Profile Form - Mgmt InfoTab

Attribute	Value
Profile Name	<p>A descriptive name that should match the service/function provided</p> <p>The prefix of profile name should start with a short but meaningful name that indicates the routing function and the Access Island and the service potential of the general profile, with the number of ports. Refer to 7.4.1. This is used for scoping.</p> <p>SPSI-AI01-II_2V_3T (VoIP Telephone, 1 Internet, 2 Video, 3TLS)</p> <p><i>Note: Profile names can only be up to 20 characters. To include all services, the administrator may need to delete an underscore. This is OK as long as the prefix works for scoping.</i></p>
Profile Scoping	When used in conjunction with the Triple-Play form, controls the profiles available after selecting the device.port, or controls the device.port available after selecting the Profile.
iMG/RG Bootstrap VLAN Id	The default VLAN on the RG that is used when sending the original Discover Message. This is “out of the box” (factory configuration). This is used only through bootstrap 1 usually
Persist Checkbox	Used to retain the bootstrap VLAN at the end of triple play provisioning to aid in the replacement of faulty CPE. It can also put the bootstrap VLAN on the port when the profile (with Persist checked) is applied to the port from the View/Modify screen or deployed from the deploy profile tool.
iMG/RG Mgmt VLAN Id	The VLAN used for subsequent downloads once communication is established with the AlliedView NMS. It is derived from the im.conf file.
Include Service VLANs in Profile	<p>Controls which network model is to be used.</p> <p>True - Access Island model is being used, and service VLAN fields are activated.</p> <p>False - Open Access model is being used, and service VLAN fields are de-activated.</p>
Internet VLAN	The VLAN used for internet type service
Video VLAN	The VLAN used for video type service
Voice VLAN	The VLAN used for voice type service
CES VLAN	The VLAN used for CES type service
iMG/RG Additional VLAN IDs	Shows VLAN IDs for custom VLANs. Use the Add/Remove button to open the Additional VLANs panel. Note that port service must be set to “None” to add an additional VLAN to the iMG. Refer to 7.9.8 .
System Power Management	Whether this feature is Enabled or Disabled. Refer to 7.15 .
Loop Detection	Only supported on 10M-half duplex interfaces, it is primarily intended for Ethernet links that have Baluns connected to them, which if not terminated correctly can reflect packets back. Setting to Enabled prevent this.
SNTP Server	The IP address for the SNTP server, used to derive the correct time and time settings. (Default is None .)
Daylight Saving	Enables or Disables the Daylight Savings Feature for the iMG/RG. Note that this is only for 3-7 devices. This is also available on the Services Management Window.
Time Zone	<p>Time Zone for the iMG, for example EST for Eastern Standard Time.</p> <p><i>Note: For TR-069 CPEs, this is determined by the SNTP server setting, and so SNTP Server must be filled in first. If no SNTP server is provisioned, the iMGs default to “clock.fmt.he.net”.</i></p>
Limited User Login	User ID of user with limited capabilities

TABLE 7-7 Create RG General Port Profile Form - Mgmt InfoTab (Continued)

Attribute	Value
New Limited User Password	Password for the Limited User
New Manager Password	Password for the user that the AlliedView NMS uses when it provisions the device. The userID is part of AlliedView NMS, has super user privileges, and cannot be changed .
Super User Login	The super user that can be created and changed by the administrator.
New Super User Password	The password for the Super User.
Split Management	A subscriber (rather than an NMS administrator) can configure wireless parameters on wireless iMG devices. Refer to 7.9.6.
Mgmt. Subnets	Controls what IP addresses are allowed to log into the iMG/RG using CLI or the iMG/RG's web-based GUI. If no values are entered, any IP address can access the iMG/RG (using a login ID and password). Once at least one value is entered, the AlliedView NMS will add its own entry. Name - A name to identify the subnet. This cannot begin with a digit. Subnet Address - An IP address. Used with the Mask Field to define a range. Mask - The mask used with the Subnet Address to define a range. Start Address - The first address in a range End Address - The last address in a range.
Copy value from Profile	To create a new profile, the user can select an existing profile, which will fill in the values from that existing profile. The user can then modify any fields.
Create	Activated when a Profile Name has been typed, it creates the profile with the entered values.
Cancel	Closes the window

Note: To configure the network as depicted in Figure 7-1, the RG General Profile should represent a specific Access Island (a group of iMAPs sharing a common set of VLANs and router[s]), so the Profile is defining Level-3 details and the VLAN values associated with it. Therefore if you had 4 access Island you would have 4 general profiles. This is assuming Virtual Routing is not in use.

Note: For the RG613, RG656, and the iMG646, only the manager password should be changed. (This is because a password can only be changed by switching to the user for that password. If the administrator changes the password for the Limited User (with the switching to the Limited User), the RG cannot switch back to Manager User. As a result, if the password for the Limited User is changed first, and then the Manager User password is changed within 5 minutes, there will be a time-out and the Manager User password will not be changed. (Waiting 5 minutes between these actions, or changing the Manager User first allows both changes to be made.)

Note: Future iMG/RG software will allow full support of multiple user id's and privilege levels.

Create Profile Profile Name: DVKLNDAIT-1T_1L_1V Profile Type: RG General

Profile Attributes

Mgmt. Info **Wireless** Port Assignment IP Routes

Attribute	New Value	Attribute	New Value
Wireless Attributes:	Settings	Authentication:	Open
Status:	Enabled	Encryption:	None
Hide SSID:	False	WPA1:	Disabled
Profile:	Mixed G WiFi	WPA2:	Disabled
Transmit Rate:	1 Mbps	WPA2 AES CCMP:	Disabled
Automatic Channel Selection:	Enabled	WPA2 PreAuth:	Disabled
Default Channel (1..14):		WPA2 TKIP:	Disabled
Country:	United States		
Intra-BSS Relay:	Enabled		
Default Tx Key(0..3):	0		
Fragmentation Threshold(0..999999):	0		
Max. Frame Burst (0..999999):	0		
RTS Threshold (0..999999):	0		
802.1 Authentication:	Disabled		
802.1 Key Transmission:	Disabled		
802.1 Rekey Timeout(20..3600):	None		

Copy values from profile: timGENERAL Copy

Create Cancel Help

FIGURE 7-16 RG General Profile - Wireless Tab

The wireless tab allows the iMG634WA/WB to be configured, and uses the standard wireless parameters.

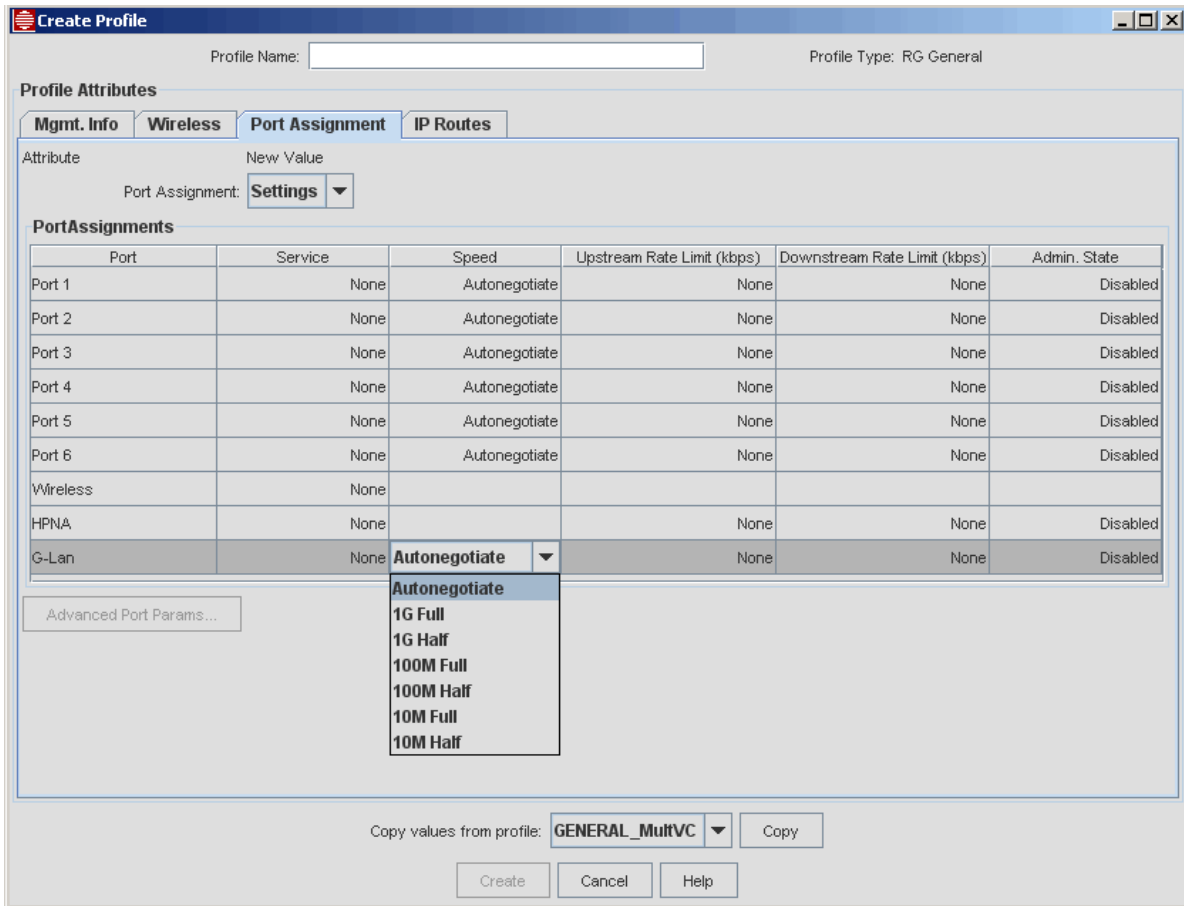

FIGURE 7-17 RG General Profile - Port Assignment Tab

TABLE 7-8 Create RG General Port Profile Form - Port Assignment Tab

Attribute	Value
Port Assignments	<p>The selection made here controls which fields appear on the Provision New Triple Play Customer form.</p> <p>Settings - Port assignments will not be displayed when provisioning a new customer. The values as set in the profile will be used.</p> <p>Defaults - Port assignments from the profile will be displayed on the provisioning screen for review and can be modified when provisioning a new customer.</p> <p><i>Note: For either setting, after a customer is provisioned, port assignments can always be viewed/modified from the Port Management View/Modify screen.</i></p>
Service	<p>None - No service will be configured on the port.</p> <p>Internet - A data service (type not determined here) will be configured on the port.</p> <p>TLS - Transparent LAN Service will be configured on the port.</p> <p>Video - A video service (type not determined here) will be configured on the port.</p> <p>Voice - A VoIP phone is connected to the LAN port (configured on Voice VLAN) This service is not available on the HPNA port.</p> <p>HPNA - used for the iMG6x6MOD. Refer to 7.6.8.</p> <p>G-Lan - This is the port available when the 1 Gigabit WAN with RJ-45 LAN card is used. This allows the customer to provision services on the G-Lan port.</p> <p>Internet/Video - For Media Room. In this configuration a new service is configured for a LAN port called "Internet/Video" to indicate that the port can be used for video or data traffic. Refer to 7.6.10.1.</p>
Speed	<p>Autonegotiate - The line will chose the maximum speed/direction it can support.</p> <p>Coax - Used for P2P RG59 + RG6 coax (10 Meg Full Duplex) in a star/hubslope top with software loop detection.</p> <p>1G Full</p> <p>1G Half</p> <p>100M Full -</p> <p>100M Half -</p> <p>10M Full -</p> <p>10M Half -</p>
Upstream Rate Limit (kbps)	Speed in kbps for the maximum upstream rate
Downstream Rate Limit (kbps)	Speed in kbps for the maximum downstream rate
Admin. State	<p>These are set in the General Profile. As with other parameters in the profile, if the admin state in the profile differs from that on the iMG, then a profile out of sync alarm is generated on re-discovery.</p> <p>For profiles that existed before this enhancement, the admin state for ports that have a service is set to enabled, and for those ports without a service, the admin state is set to disabled.</p>

TABLE 7-8 Create RG General Port Profile Form - Port Assignment Tab

Attribute	Value
Advanced Port params	Brings up specific features: - Disable on Power Failure feature for the port. Refer to 7.15.2. - Flow Control - Refer to 7.16 - DSCP Status - Enables the support of DSCP IP field on the incoming frames. Refer to the <i>Allied Telesis Gateway Software Reference Manual</i> , command SWITCH SET SUPPORT DSCP. - Additional Untagged VLAN IDs - Refer to 7.9.8. - Additional Tagged VLAN IDs - Refer to 7.9.8.
Copy value from Profile	To create a new profile, the user can select an existing profile, which will fill in the values from that existing profile. The user can then modify any fields.
Create	Activated when a Profile Name has been typed, it creates the profile with the entered values.
Cancel	Closes the window

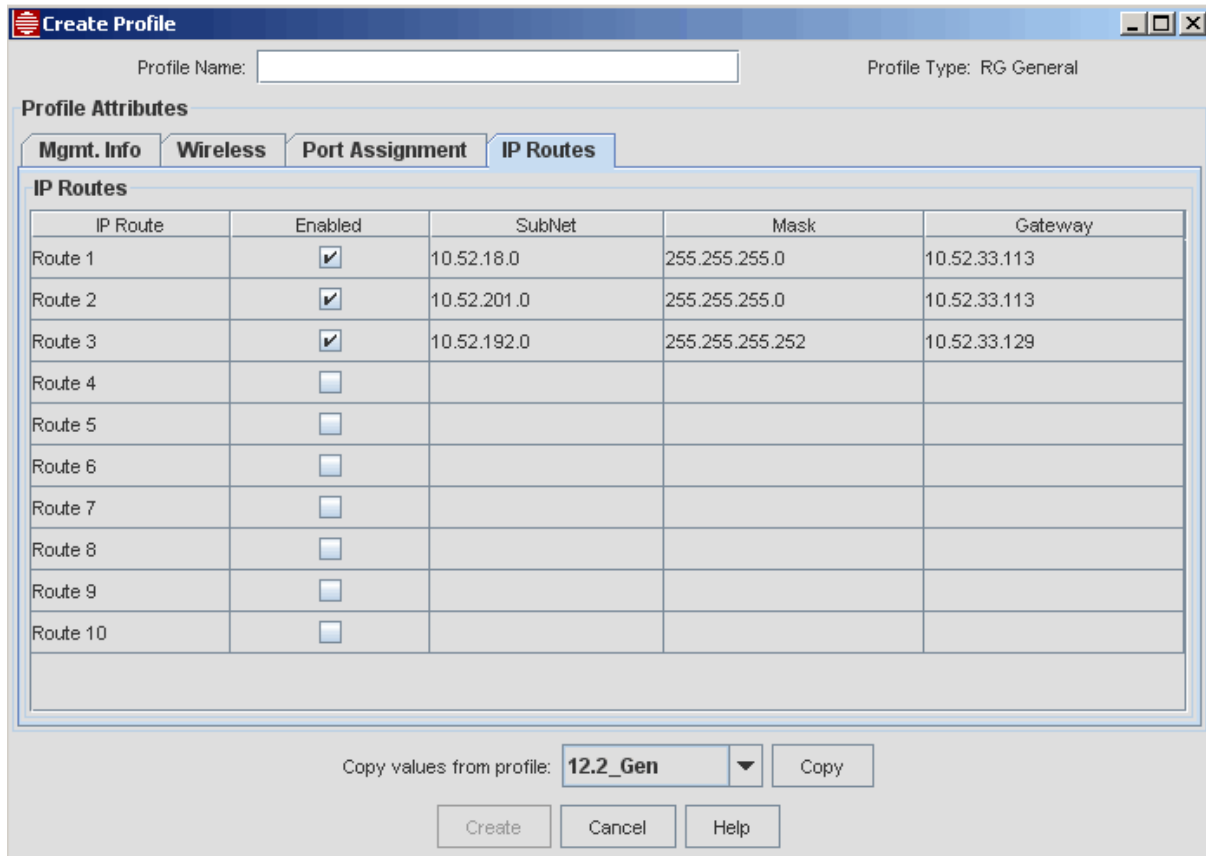

FIGURE 7-18 RG General Profile - IP Routes Tab

TABLE 7-9 Create RG General Port Profile Form - IP Routes Tab

Attribute	Value
IP Route	IP Routes that are available for the RG The user should always create a route to the “back office” management subnets. (The AlliedView has one as well that is unavailable to the user.)
Enabled	Activates the other IP Route Fields
Subnet	Subnet address
Mask	Mask over the subnet address, usually 255.255.255.0
Gateway	IP address for the Gateway server
Copy value from Profile	To create a new profile, the user can select an existing profile, which will fill in the values from that existing profile. The user can then modify any fields.
Create	Activated when a Profile Name has been typed, it creates the profile with the entered values.
Cancel	Closes the window

Note: The administrator should also add route(s) that include the entire scope of management subnets that will require “direct” access to RGs. (The AlliedView NMS will always have direct access but TAC/NOC Staff with their PCs/workstations may not unless specifically included in a route.)

Note: For Media Room, the routes table in General profile allows up to 10 different routes in the iMG because media room devices connected to the iMG may request services configured in separate subnets on the upstream network. Refer to 7.6.10.1.

7.4.3 RG Internet Profile

7.4.3.1 Overview

Although this subsection describes all of the fields for the RG Internet Profile, a specific feature, Security, is highlighted since this feature involves four tabs so that attributes for the three main areas for Security (Security, Firewall, and NAT) can be data-filled in separate forms.

The security system provides a single point where all traffic entering and leaving the private network can be controlled.

The system has these main parts:

- Security - This provides the following:
 - Enable/disable all areas of the Security System (NAT and Firewall)
 - Add IP interfaces to Security that are used to configure the NAT and Firewall.
 - Configure **Triggers** - Triggers are user to inform the security mechanism to expect secondary sessions and handle the situation dynamically, allowing the secondary sessions for data flow for the duration of the session. The user configures the iMG/RG with a range of primary port number(s). The Primary port number refers to the TCP/UDP port number to which the primary (starting) session of the application is established. During session set up, if there is a local host that was expecting the incoming session, then the session is established. If a local host is not found, then the packet is discarded. This mechanism enables the iMG/RG to allow in only those incoming secondary sessions that should be allowed in, and can reject malicious attempts to establish incoming sessions.
 - **Timeout** - When a session using a secondary port is being closed, an exchange of FIN, FIN/ACK packets stops passing packets for that session. For cases where this does not occur (UDP, or one end is simply turned off), the user can configure a period of inactivity before the session is closed and the iMG/RG will no longer forward packets for the session.

- **Session Chaining** - Some applications spawn their own secondary sessions. This process is known as session chaining. When secondary sessions are successfully established, the source/destination addresses of the session will also be added to the table of currently open primary sessions.
- **Firewall** - The Firewall feature ensures that only traffic that has been **already defined** is allowed to access the internal network. This is done by provisioning the following:
 - **Port Filters** - These are port attributes that define:
 - What protocol type is allowed (specified using the protocol number or the protocol name)
 - The range of source and destination port numbers allowed
 - The direction that packets are allowed to travel in (inbound, outbound, neither, or both)
 - **Validators** - how the Firewall handles packets based on the source/destination IP address.
- **Intrusion Detection System (IDS)** - This protects the system from the following kinds of attacks:
 - **DOS (Denial of Service) attacks** - a DOS attack is an attempt by an attacker to prevent legitimate hosts from accessing a service.
 - **Port Scanning** - an attacker scans a system in an attempt to identify any open ports.
 - **Web Spoofing** - an attacker creates a 'shadow' of the World Wide Web on their own machine, however legitimate host sees this as the 'real' WWW. The attacker uses the shadow WWW to monitor the host's activities and send false data to and from the host's machine.

There are parameters that are filled out to configure each type.

- **Network Address Translation (NAT)** - The basic NAT feature is that the devices in the internal network have their own IP addresses and yet access the external network using a separate internet address, and this is the only address devices on the external network see. Doing this provides both a conservation of public IP addresses and security. Security is provided by keeping an internal table of the source IP address and source port as well as a substitute source port number. Packets coming from the external network must include the substitute port number or the packet is dropped.

In some cases, the user needs to set up static IP addresses/port mappings. This is done using Global Pools and Reserved Mappings.

- A **Global Pool** is a range of external IP addresses that are available, rather than one. The reason global pools are used is so that you can map an outside address to a specific internal interface. This is called reserve mapping.
- **Reserved Mapping** is used for mapping an IP address from the Global Pool to an individual address of a device in the internal network. When NAT receives a message, it uses its internal interface to forward the packet **to the same port number** on a selected internal computer, as well as any responses from the internal computer that are forwarded to the requesting external computer. Reserved mappings can also be used so that different internal hosts can share the same global address by mapping different ports to different hosts. For example, Host A is an FTP server and Host B is a Web server, and by mapping the FTP port to host A and an http port on Host B, both hosts can use the same external address.
- **Internet Key Exchange (IKE)** - To supports NAT IPSec traversal, you specify how Internet Key Exchange (IKE) packets are translated. IKE establishes a shared security policy and authenticates keys for services that require keys, such as IPSec. Before any IPSec traffic can be passed, each router/firewall/host must verify the identity of its peer. The user specifies whether the source port will be translated for IKE packets, or IKE cookies are used to identify IKE sessions.

7.4.3.2 General Internet Info Tab

This form controls whether a Bridged or Routed Service is to be configured. Refer to the following figure.

Create Profile _ □ ×

Profile Name: Profile Type: RG Internet

Profile Attributes

General Internet Info | Security | Firewall | NAT

Attribute New Value

Internet Service Type: **Bridged Service** ▼

Include Internet VLAN in Profile: **True** ▼

iMG/RG Internet VC/VLAN ID (2..4094):

Use PPPoE: ▼

TCP MSS Clamp: **Disabled** ▼

iMG/RG Local Customer VLAN ID (2..4094):

Use DHCP to obtain WAN IP Address: **False** ▼

DNS Servers (list of IP Addrs. or None):

Local IP Address:

Local Mask:

Local DHCP Start IP Address:

Local DHCP End IP Address:

Rate Limiting: **Disabled** ▼

Up. Rate Limit (1..50000 kbps):

Up. Burst Size (1..67108 bps):

Up. Scalar (1..100):

Down. Rate Limit (1..50000 kbps):

Down. Burst Size (1..67108 bps):

Down. Scalar (1..100):

Copy values from profile: **BridgedINET** ▼

FIGURE 7-19 iMG/RG Internet Profile - General Tab

TABLE 7-10 Create RG Internet Port Profile Form

Attribute	Value
Profile Name	<p>A descriptive name that should match the service/function provided.</p> <p><i>Note:</i> Profiles that use the Access Island (AI) concept have the 'Include Internet VLAN in Profile' set to False. For the Open Access (OA) model, the field is set to True and a VLAN number can be entered in the 'iMG/RG Internet VLAN ID' field (2..4094)</p> <p>Example Names:</p> <ul style="list-style-type: none"> • BasicHomeInetAI (Security, and therefore Firewall and NAT disabled) • BasicHomeInetOA (same as above but includes internet VLAN ID) • BusinessInetAI (Security and Firewall are Enabled but any attributes datafilled are not included as part of the Profile) • BusinessInetOA (same as above but includes internet VLAN ID) • BusinessStatic (Routed Service) • HomeNetworkingAI (Security, Firewall, and NAT are Enabled and any attributes datafilled are included as part of the Profile) • HomeNetworkingOA (same as above but includes internet VLAN ID) • Bridged Int Srv (Bridged Service)
Internet Service Type	<p>Bridged Service</p> <p>Routed Service</p>
Include Internet VLAN in Profile	<p>The value entered here depends on the network model:</p> <p>False - The Access Island model is used, and the Internet VLAN Id field is blank.</p> <p>True - The Open Access model is used, and the Internet VLAN Id field is activated.</p>
iMG/RG Internet VLAN Id	<p>The VLAN that supports internet service.</p> <p>If the 'Include Internet VLAN in Profile' is set to True, this field is activated.</p>
Use PPPoE	<p>Determines if the PPPoE protocol is to be used to establish the connection between the iMG and the ISP. With the PPPoE protocol, the iMG will broadcast a Discovery Initiation packet over the network VLAN, and through negotiation the PPPoE server will determine each other's MAC address and Session ID, which together define the one-to-one connection. Therefore, when this field is set to True, the Use DHCP to obtain WAN IP Address is deactivated.</p>
TCP MSS Clamp	<p>When using the PPPoE client on the iMG, either the iMG or the PPPoE concentrator/RAS should be configured to clamp the maximum TCP MSS value. For PPPoE the maximum mss is 1452. Without this clamp, connectivity issues could occur, and access to some websites could fail. Refer to the <i>Software Reference Manual for the Allied Telesis Gateway</i>.</p>
Internet MTU	<p>This does not appear on the Profile, but does show up on the Service Management form. The MTU is the Maximum Transmission Unit - the maximum packet size (in bytes) an interface can handle. The MTU should be set to a value appropriate for the transport attached to the interface (typically from 576 to 1500 bytes). Refer to the <i>Allied Telesis Gateway Product Family Software Reference Manual</i> for more information.</p>

TABLE 7-10 Create RG Internet Port Profile Form

Attribute	Value
iMG/RG Local Customer VLAN Id	VLAN that is local to the RG only
Use DHCP to Obtain WAN IP Address	If True, use DHCP Discovery to obtain the network-side IP address for the RG. If False, static IP provisioning and IP/masks must be manually entered.
DNS Servers	DNS servers associated with the DHCP discovery
Local IP address	The IP address of the iMG/RG for the LAN that it services. <i>Note: This and the remaining fields are activated only when NAT is enabled on the NAT tab.</i>
Local Mask	The masking for the local IP addresses. Usually this is 255.255.255.0 so that the local addresses can range from 1 to 255.
Local DHCP Start IP Address	The first address in the range for a local device in the local network. This possible range must be derived from the Local IP Address and the Local Mask.
Local DHCP End IP Address	The last address in the range for a local device in the local network.
Rate Limiting (CPU-based)	<p>Enable or Disable Rate Limiting</p> <p>When enabled, the upstream and downstream attributes (Rate Limit, Burst Size) are editable.</p> <p>The downstream rate limiting applies to Internet VLAN traffic and is used for wireless traffic because the downstream rates are applied on WAN port when the traffic enters the iMG.</p> <p>Upstream rate limiting applies to Local VLAN traffic which applies to LAN ports but not wireless because classifiers are applied on the transport and the wireless transport is not the same as LAN transport.</p> <p>However, for certain wireless IMG 3.8 devices, you can configure the upstream rate limits. Note that the NMS will use the same rate limits values that are currently set for wired ports on wireless. The devices that support this are:</p> <ul style="list-style-type: none"> • iMG616-W • iMG634-A-W-R2 • iMG634-B-W-R2 <p>These fields can also be changed on the Service Management Form for these wireless devices.</p>
Scaler	Represents the weight of each byte of data coming over the channel. The higher the scaler value the lower the worth each byte of data is counted for rate limiting purposes. This allows a more precise reflection of actual network traffic.
Copy values from profile	To create a new profile, the user can select an existing profile, which will fill in the values from that existing profile. The user can then modify any fields.
Create	Activated when a Profile Name has been typed, it creates the profile with the entered values.
Cancel	Closes the window

7.4.3.3 Security Tab

This tab controls whether the Security System and its subsystems will be enabled, and if so, the attributes for these subsystems. Therefore, the user should note that **if the Security is set to Disabled, the fields to Enable Firewall and NAT in their tabs are disabled**. Refer to the following figures.

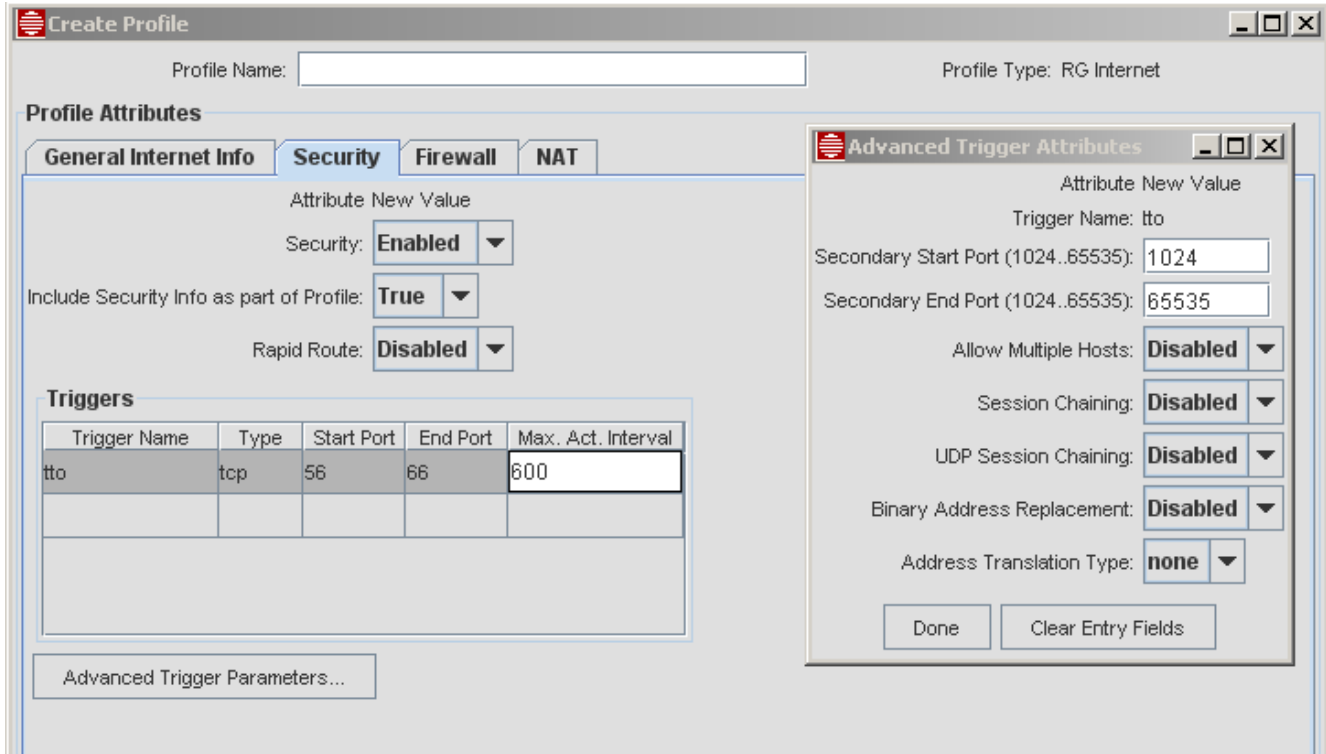

FIGURE 7-20 RG Internet Profile - Triggers

TABLE 7-11 Create RG Internet Profile Security Tab

Attribute	Value
Security	Whether the feature is Enabled or Disabled. This option is activated only for Routed Service. Moreover, it controls whether the Enable/Disable fields for Firewall and NAT are activated. <i>Note: Security does not have to be enabled to enter Triggers and Mgmt. Stations, although this would not usually be done.</i>
Include Security Info as part of Profile	Whether Triggers or Mgmt. Stations are included in the profile.
Rapid Route	Used to configure the iMG for Media Room support. This enhances NAT routing functionality in CPE for better throughput of routed traffic. Refer to 7.6.10.2

TABLE 7-11 Create RG Internet Profile Security Tab

Attribute	Value
Triggers	<p>A set of attributes that allows an application to open a secondary port to transport packets. A trigger opens a secondary port dynamically, and allows you to define the length of time the port can be inactive before it is closed.</p> <ul style="list-style-type: none"> - Trigger Name - a label that helps identify the trigger. It cannot start with a digit. - Type - protocol for the application, tcp or udp - Start Port - First port in the range for the control session. - End Port - Last port in the range for the control session. - Max. Act. Interval - the amount of time (in milliseconds) the secondary port is allowed to pass traffic before it is closed. The default is 3000 (3 seconds).
Advanced Trigger Parameters	<p>These are attributes for when the user wants more control over the trigger feature:</p> <ul style="list-style-type: none"> - Secondary Start Port - The start of the secondary port range for an existing trigger. - Secondary End Port - The end of the secondary port range for an existing trigger. - Allow Multiple Hosts - Controls whether a secondary session can be initiated to/from same or different remote hosts on the same trigger. - Session Chaining - Whether TCP dynamic sessions can also become triggering sessions, which allows multi-level session triggering. - UDP Session Chaining - Whether both UDP and TCP sessions also become triggering sessions, , which allows multi-level session triggering. - Binary Address Replacement - enables/disables binary address replacement on an existing trigger. You can then set the type of address replacement (TCP, UDP, both or none) - Address Translation Type - specifies what type of address replacement is set on a trigger. Incoming packets are searched in order to find their embedded IP address. The address is then replaced by the correct inside host IP address, and NAT translates the packets to the correct destination. You can specify whether you want to carry out address replacement on TCP packets, on UDP packets, or on both TCP and UDP packets.
Copy values from profile	<p>To create a new profile, the user can select an existing profile, which will fill in the values from that existing profile. The user can then modify any fields.</p>
Create	<p>Activated when a Profile Name has been typed, it creates the profile with the entered values.</p>
Cancel	<p>Closes the window</p>

7.4.3.4 Tab

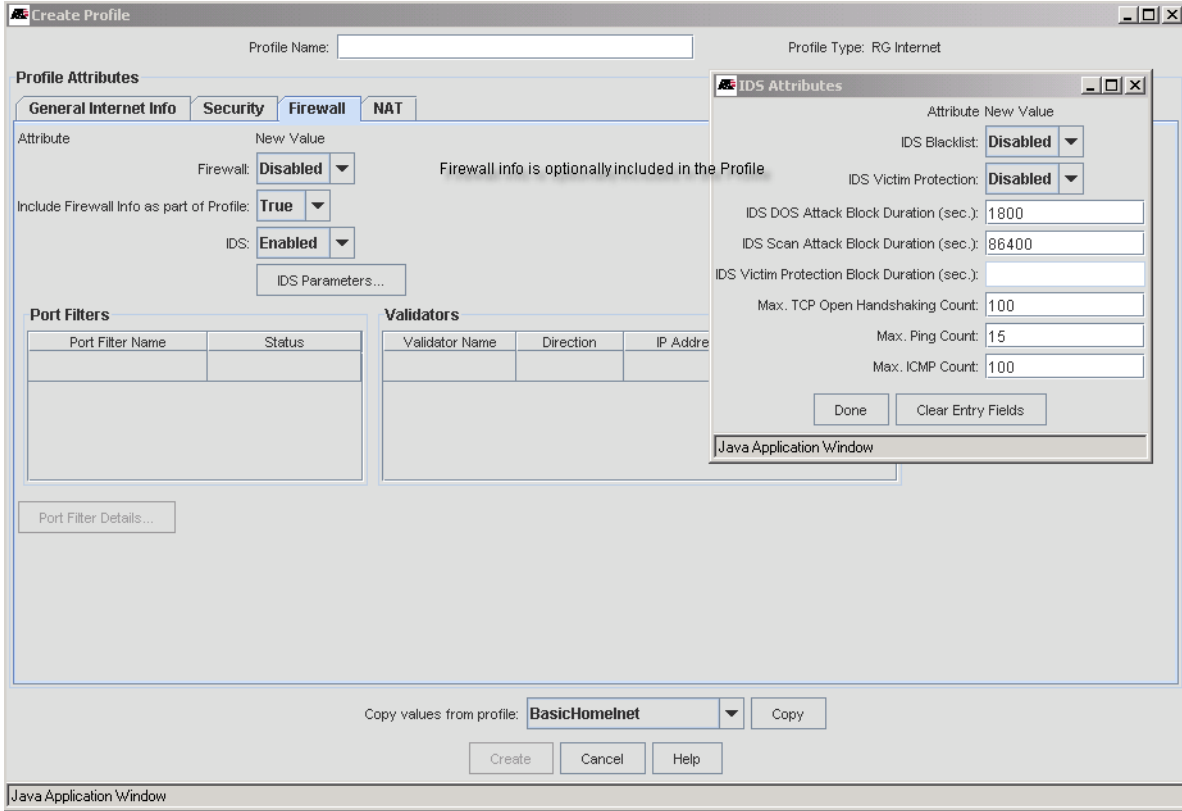

FIGURE 7-21 RG Internet Profile - Firewall Tab -IDS Attributes

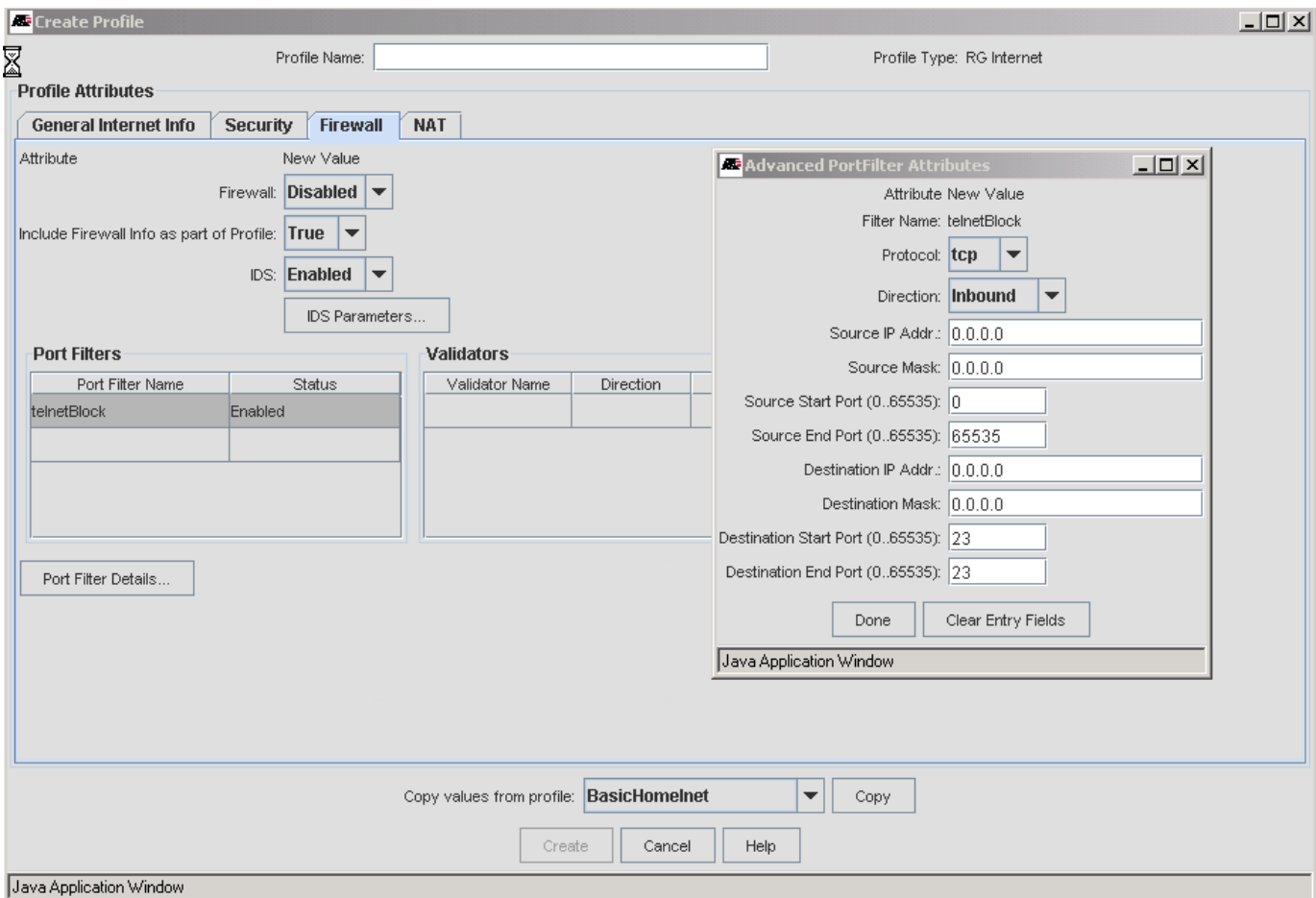

FIGURE 7-22 RG Internet Profile - Firewall Tab -Port Filters Attributes

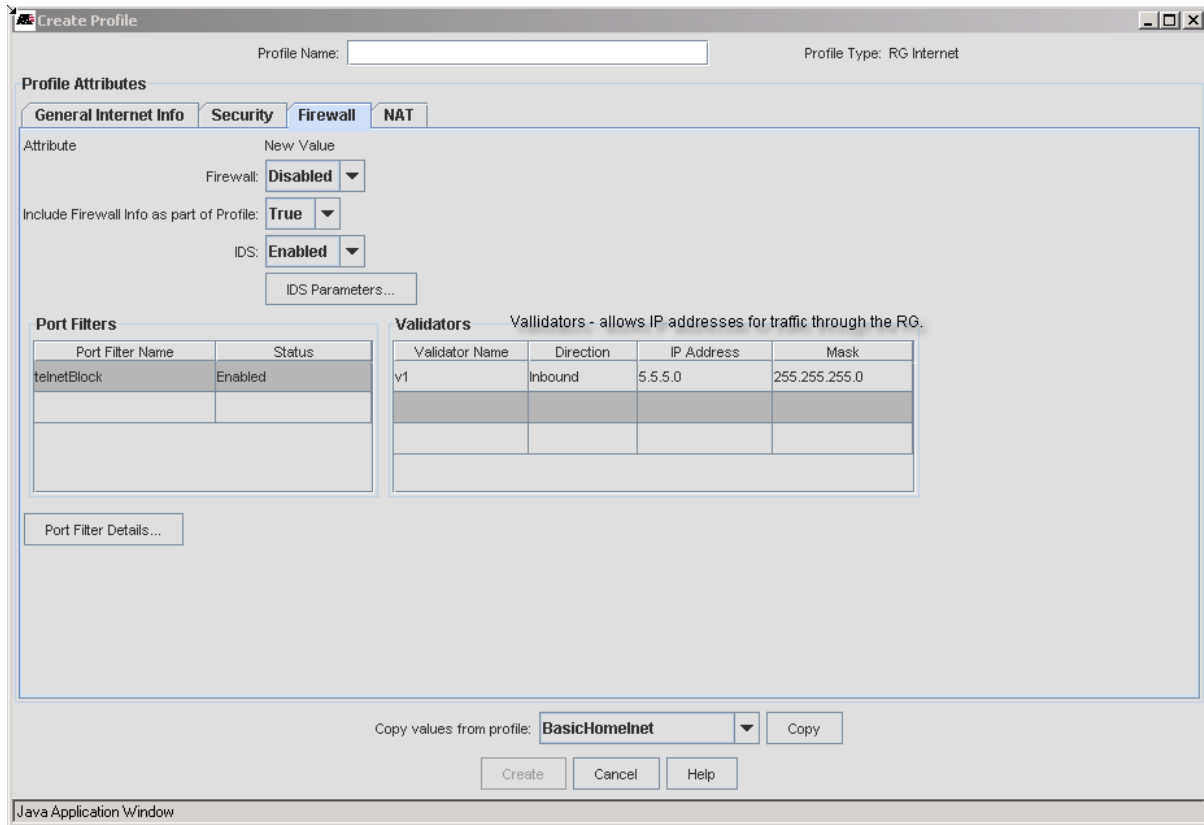

FIGURE 7-23 RG Internet Profile - Firewall Tab -Validators Attributes

TABLE 7-12 Create RG Internet Profile Firewall Tab

Attribute	Value
Firewall	Whether the feature is Enabled or Disabled. This option is activated only for Routed Service. <i>Note: Security does not have to be enabled to enter IDS and Port Filters.</i>
Include Firewall Info as part of Profile	Whether IDS and Port Filters are included in the profile. If False, the attributes are configured on the iMG/RG but not activated.

TABLE 7-12 Create RG Internet Profile Firewall Tab

Attribute	Value
IDS parameters	<p>Whether IDS is Enabled or Disabled. If Enabled, the IDS Parameters window is activated.</p> <p><i>Note: IDS parameters can be datafilled and enabled regardless of whether the Firewall feature is enabled, since IDS applies to the iMG/RG, and is not associated with specific Firewall attributes.</i></p> <ul style="list-style-type: none"> - IDS Blacklist - Enabled or Disabled - Blacklisting denies an external host access to the system if IDS has detected an intrusion from that host. Access to the network is denied for ten minutes. - IDS Victim Protection - Enabled or Disabled - This protects the system against broadcast pings with a spoofed source address. Packets are blocked for a specified duration (600 minutes by default, can be changed using Duration field below) - IDS DOS Attack Block Duration - A DOS attack is an attempt by an attacker to prevent legitimate users from using a service. If a DOS attack is detected, all suspicious hosts are blocked for a set time limit. Default is 1800 seconds (30 minutes) - IDS Scan Attack Block Duration - If hosts are blocked, sets the duration of the block time limit. - IDS Victim Protection Block Duration - If victim protection is enabled, specifies the duration of the block - Max. TCP Open Handshaking Count - The maximum number of unfinished TCP handshakes allowed before a flood is detected. See Note below. - Max. Ping Count - The maximum number of pings allowed before an echo storm is detected. See Note below. - Max. ICMP Count - The maximum number of ICMP packets allowed before a flood is detected. See Note below. <p><i>Note: For the Max. parameters above, the attacker is blocked by the time defined in the IDS DOS Attack Block Duration field.</i></p>
Port Filters - These are the rules that determine what kind of traffic can pass between the external and internal network.	<p>These allow blocking of certain types of traffic</p> <ul style="list-style-type: none"> - Port Filter Name - A label to help identify the filter. It cannot start with a digit. - Status - Enabled or Disabled <p>Port Filter Details is activated when a Port Filter Name is selected</p> <ul style="list-style-type: none"> - Protocol - udp, tcp, or icmp. For ICMP, there are no Start and Destination Port attributes. Also, these are the only protocols supported here. - Direction - Inbound (allows packets from the external to the internal network), Outbound (allows packets from the internal to the external network) or Both - Source IP Address - The IP address from which packets of the protocol can be sent out. This is used in conjunction with the Source Mask. - Source mask - The mask for the Source IP Address. - Source Start Port - The start of a source port range for udp or tcp packets - Source End Port - The end of a source port range for udp or tcp packets - Destination IP Addr. - The IP address to which packets of the protocol can be sent. This is used in conjunction with the Destination Mask. - Destination Mask - The end of a destination port range for udp or tcp packets - Destination Start Port - The start of a destination port range for udp or tcp packets - Destination End Port - The end of a destination port range for udp or tcp packets

TABLE 7-12 Create RG Internet Profile Firewall Tab

Attribute	Value
Validators - Blocks the traffic to/from the IP addresses/masks defined. All other traffic is allowed.	<ul style="list-style-type: none"> - Validator Name - A label to help identify the validator. It cannot start with a digit. - Direction - Can be one of the following: <ul style="list-style-type: none"> - Inbound (Validator blocks incoming traffic based on IP address/mask) - Outbound (Validator blocks outgoing traffic based on IP address/mask) - Both (Validator filters both incoming and outgoing traffic based on IP address/mask). - IP Address - The IP address to be filtered. - Mask - The mask, such as 255.255.255.0 or 255.255.255.255 (single address)
Copy values from profile	To create a new profile, the user can select an existing profile, which will fill in the values from that existing profile. The user can then modify any fields.
Create	Activated when a Profile Name has been typed, it creates the profile with the entered values.
Cancel	Closes the window

7.4.3.5 NAT Tab

The NAT form allows you to set up static ip address/port mappings to the local address space.

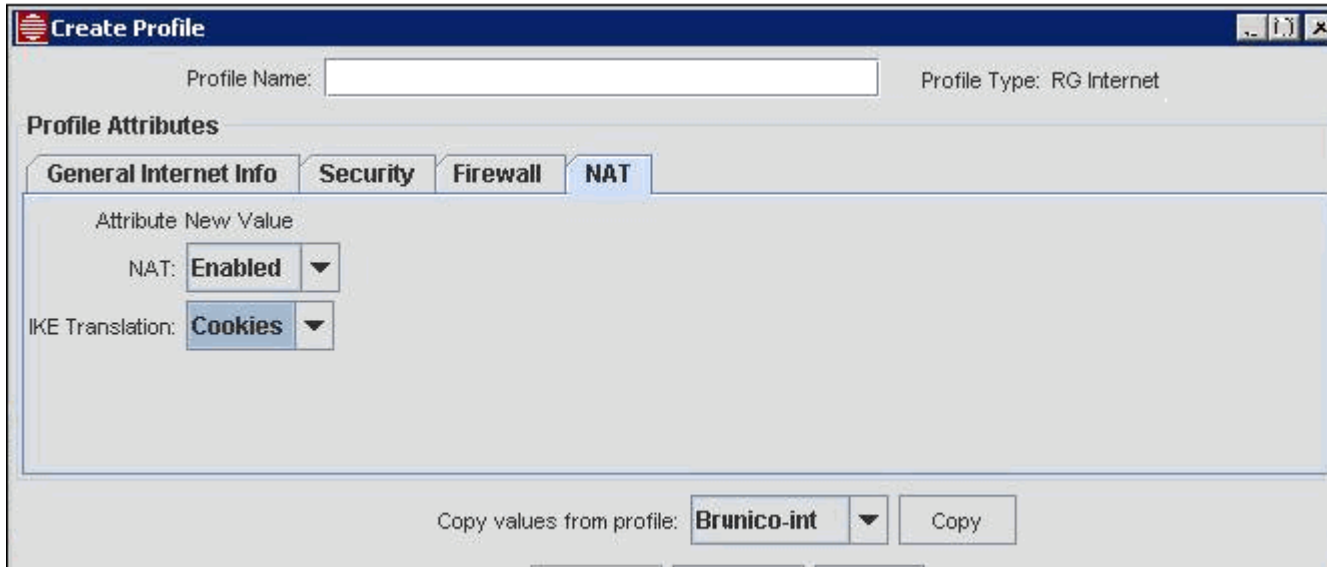

FIGURE 7-24 RG Internet Profile - NAT Tab

TABLE 7-13 Create RG Internet Profile NAT Tab

Attribute	Value
NAT	Whether the feature is Enabled or Disabled. This option is activated only for Routed Service.
IKE Translation	Specifies how Internet Key Exchange Packets are translated. - Ports - Source port is translated for IKE packets. - Cookies - IKE cookies are used to identify IKE packets.
Include NAT Info as part of Profile	Whether Global Pools and Reserved Mappings are included in the profile.
Copy values from profile	To create a new profile, the user can select an existing profile, which will fill in the values from that existing profile. The user can then modify any fields.
Create	Activated when a Profile Name has been typed, it creates the profile with the entered values.
Cancel	Closes the window

7.4.4 Video Profile

The screenshot shows a 'Create Profile' dialog box with the following fields and values:

Attribute	New Value
Profile Name:	[Empty]
Profile Type:	RG Video
Include Video VLAN in Profile:	True
iMG/RG Video VC/VLAN ID (2..4094):	40
Use DHCP to obtain WAN IP Address:	[Empty]
IGMP Mode:	None
Multicast Acceleration:	Disabled
IGMP Timeout (1..65535 seconds):	[Empty]
IGMP Version:	3
IGMP Leave Time:	[Empty]
IGMP Security:	Disabled
IGMP Security Autolearning:	Disabled
Trusted Host Limit (1..6):	1
IGMP Default Fast Leave:	Enabled

Copy values from profile: ALT-NE-Video [Copy]

[Create] [Cancel] [Help]

FIGURE 7-25 RG Video Port Profile

TABLE 7-14 Create RG Video Port Profile Form

Attribute	Value
Profile Name	<p>A descriptive name that should match the service/function provided</p> <p>Example Names:</p> <ul style="list-style-type: none"> • Flood - This would match the NONE for IGMP Mode (IGMP Snooping turned off) • Snoop (646 and 656) - Note that all RG600 series RG/IMG will support snooping in the next sw release. • Proxy - The RG performs the IGMP function. Possible Names are: <p>(These are for ADSL only)</p> <ul style="list-style-type: none"> • ManualSec2/Proxy (up to two STBs and must specify STN MAC address) • ManualSec3/Proxy (up to three STBs) • AutoSec2/Proxy (up to two STBs and STB sends its MAC address) • AutoSec3/Proxy (up to three STBs) <p>(These will be available in future releases as they are supported.)</p> <ul style="list-style-type: none"> • ManualSec2/Snoop • ManualSec3/Snoop • AutoSec2/Snoop • AutoSec3/Snoop
Include Video VLAN in Profile	<p>The value entered here depends on the network model:</p> <p>False - The Access Island model is used, and the Internet VLAN Id field is blank.</p> <p>True - The Open Access model is used, and the Internet VLAN Id field is activated.</p>
iMG/RG Video VLAN Id	<p>The VLAN that supports internet service.</p> <p>If the 'Include Video VLAN in Profile' is set to True, this field is activated.</p>
Use DHCP to obtain WAN IP Address	<p>- Used for the Media Room feature. Refer to 7.6.10.3.</p>
IGMP Mode	<p>None</p> <p>Snooping</p> <p>Proxy</p>
Multicast Acceleration	<p>Used for the Media Room feature. Refer to 7.6.10.3.</p>
IGMP Time-out	<p>Number of seconds before channel is dropped because of no IGMP message.</p> <p>The IGMP time-out must be at least 10 seconds greater than the router queries, but not so much higher that it will time-out.</p>
IGMP Version	<p>This field applies to the iMG with version 4-1 and above. Possible values are 1 to 3, with 3 being the default. Refer to the <i>iMG Software Reference Manual</i>.</p>
IGMP Leave Time (0..255)	<p>Time in seconds between when the Leave message form the last host is received and the multicast connection is dropped.</p>

TABLE 7-14 Create RG Video Port Profile Form

Attribute	Value
IGMP Security	<p>Enabled or Disabled</p> <p>When “learning” is enabled the RG will only allow those trusted hosts (STB) if specified in the Triple Play screen to participate in IGMP (ask for broadcast channels)</p> <p>When “autolearning” is enabled as well as “learning” the RG when booting up will automatically learn “X” number of trusted hosts (STB) as specified in the video profiles “trusted host limit” field.</p> <p><i>Note: IGMP Security, Autolearning, and Trusted Host Limit are currently valid only for ADSL versions of the RG. Release 2.4 will include these features for Ethernet-based iMG/RGs (613, 613, etc.)</i></p>
IGMP Security Autolearning	Enabled or Disabled
Trusted Host Limit	Number of hosts (STBs) that the RG can support.
IGMP Default Fast Leave	Enables or Disables the default to keep track of Multicast Group membership by MAC address, so Leaves are processed immediately and the interface is removed from the Multicast Group (no timers).
Copy values from profile	To create a new profile, the user can select an existing profile, which will fill in the values from that existing profile. The user can then modify any fields.
Create	Activated when a Profile Name has been typed, it creates the profile with the entered values.
Cancel	Closes the window

7.4.5 Voice Port Profile

The following screens and tables describe the attributes for the iMG Voice Profile

Note: With the support of TR-069 iMG and its object model, the values entered in the profile may be shown differently once the iMG is provisioned and queried. (This can occur, since a profile is a template that is used to provision the device, and when the device is shown, the device will display its equivalent attributes.) The following table lists the attributes shown in the voice profile and how they may appear when displayed in the service management screen (when using Show Details).

TABLE 7-15 Profile Attributes - Profile and as Provisioned on TR-069 Device

Attribute	TR-069 device	Voice Profile Attribute
Codec (Advanced Line Attributes)	G.711MuLaw	g711u
	G.726	g726
	G.711ALaw	g711a
MGCP Profile (Advanced Voip Attributes)	NCS	Genband
	NCS	NCS
	None	(All Else)
DTMF Relay Mode (Advanced Voip Attributes)	Inband	Auto
	RFC2833	None
	SIPInfo	Out-of-Band

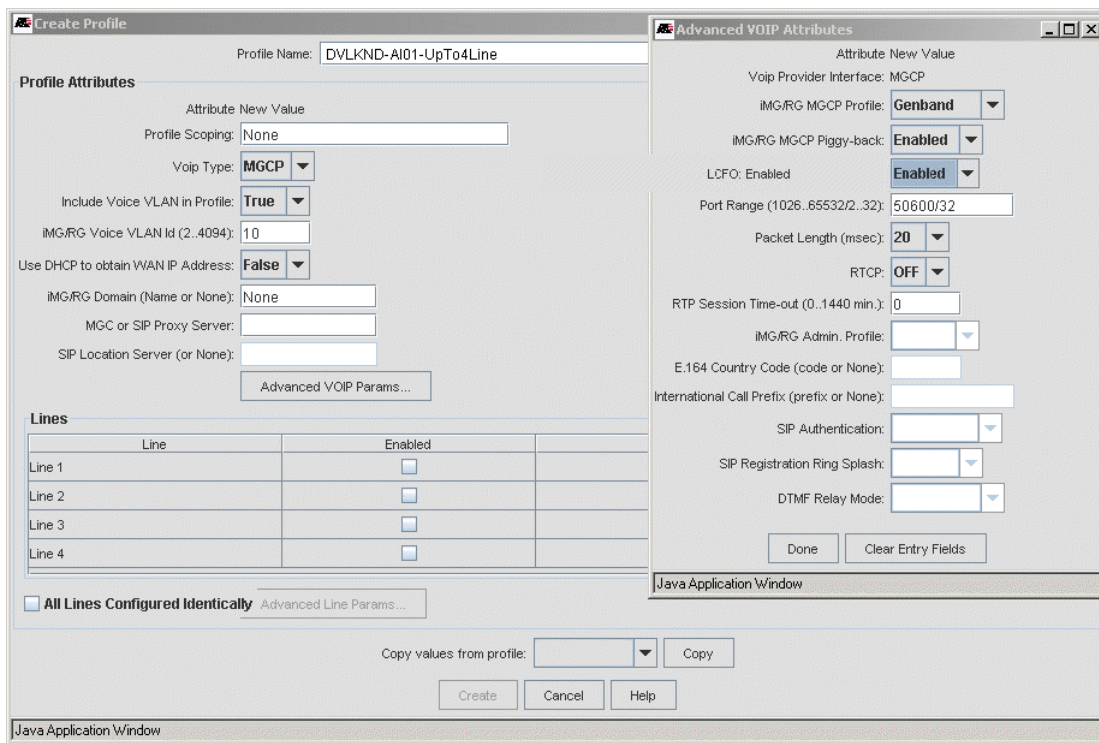

FIGURE 7-26 RG Voice Port Profile (MGCP)

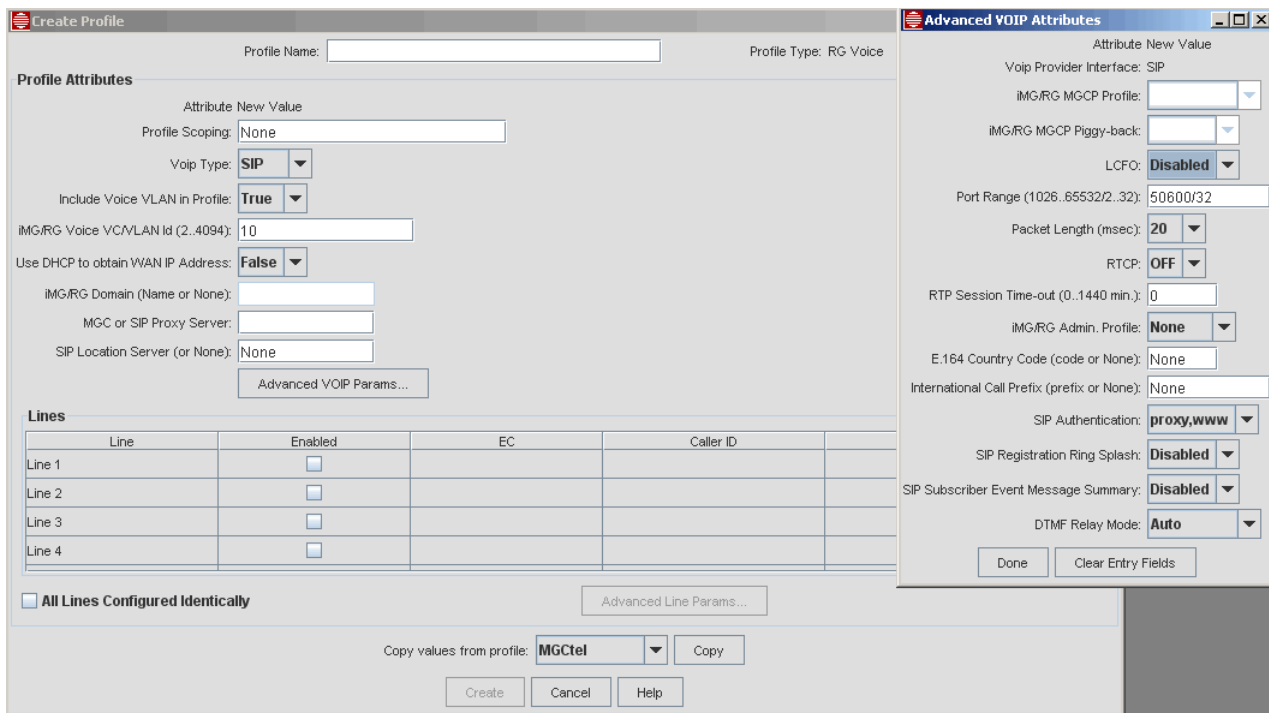

FIGURE 7-27 RG Voice Port Profile (SIP)

TABLE 7-16 Create RG Voice Port Profile Form

Attribute	Value
Profile Name	<p>A descriptive name that should match the service/function provided</p> <p>The prefix of profile name could include the string that identifies the Access Island as well as the service potential, such as:</p> <p>SPSI-AI01-UpTo4Line</p> <p><i>Note: The user would give this name to the profile because it would have four voice lines filled in; if the user had one voice line provisioned and needed to provision an additional voice line, the same profile could be used.</i></p>
Profile Scoping	<p>When used in conjunction with the Triple-Play form, controls the profiles available after selecting the device.port, or controls the device.port available after selecting the Profile.</p>
VOIP Type	<p>The protocol/server configuration to provide VOIP service:</p> <p>MGCP</p> <p>SIP</p> <p><i>Note: The only options are MGCP or SIP; specific types for each are selected in the Advanced VOIP Attributes panel.</i></p>
Include Voice VLAN in Profile	<p>The value entered here depends on the network model:</p> <p>False - The Access Island model is used, and the Voice VLAN Id field is blank.</p> <p>True - The Open Access model is used, and the Voice VLAN Id field is activated.</p>
iMG/RG Voice VLAN Id	<p>The VLAN that supports voice service.</p> <p>If the 'Include Voice VLAN in Profile' is set to True, this field is activated.</p>
Use DHCP to obtain WAN IP Address	<p>Use DHCP to obtain the network side address for the RG. This is the default, since this makes administration easier</p>
iMG/RG Domain	<p>The critical component of provisioning voice, this is used in the following ways:</p> <ul style="list-style-type: none"> - the domain that is added to the fully qualified domain name for the voice subnet. Refer to 7.2.6.4. - When using MGCP and not using a GenBand device, this can have the VoIP endpoint. The value specified must start with a @. Note that this value must match the endpoint provisioned in the other MGCP device in the configuration. <p><i>Note: The NMS supplies the "aaln/<telport number>" at the beginning of the string, and then the user continues the value with @. Therefore, values from vendors that do not follow this format are not supported, such as "\$MAC:aaln/0@[IP]". Modifying the end-point syntax is an advanced setting and should not be used unless required by the MGCP server.</i></p> <p>This value can also be changed on the iMG/RG->Voice Service tab of the service management form. Refer to 7.9.7</p>
MGC or Proxy Server	<p>Proxy Server for MGCP or SIP</p>
SIP Location Server	<p>Activated when SIP is chosen as the Voip Type</p>

TABLE 7-16 Create RG Voice Port Profile Form

Attribute	Value
Advanced VOIP Params	<p>Sets attributes for RTCP (Control parameters for RTP) or SIP. Also includes the type of MGCP/SIP to be used in the Profile:</p> <p>iMG/RG MGCP Profile (for example Genband)</p> <p>iMG/RG Admin Profile (for example Sonus)</p> <p>This is where the LCFO option is added. Refer to 7.13.</p>
Line - Enabled	Activates the other fields, with defaults of EC=8, Caller ID and Call Fwd=None
EC	Echo Cancellation - 0m 8, 16 (default), 32
Caller ID	Appears when SIP is chosen as the type of Voip
All Lines Configured Identically	After choosing one line and its attributes, when the user checks this tic box all other lines will be enabled and have the same attributes.
Advanced Line Attributes	<p>When one of the lines is chosen, this button is active, and the window that appears depends on whether the SIP or MGCP type of profile is being created. Refer to the <i>Allied Telesis Gateway Product Family Software Reference Manual</i> for details on all of these attributes.</p> <p>The following parameters are for specific features:</p> <ul style="list-style-type: none"> • Disable on Power Failure - This controls, when the System power Management feature is enabled for a device, the voice port will be disabled when there is a power failure and the iMG is using a battery. Note that some of the iMGs with 3-8 do not support this feature. This will also appear in the Service management window under the Voice Service tab. Refer to 7.15. • Fax/Modem Detection - This field will only apply to 3-7 and 3-8 devices that support this feature. For 3-8 devices the option Enhanced is added, when software will determine which mode to select. This will also appear in the Service management window under the Voice Service tab. • Call Waiting Active Prefix - Two fields are added for setting the prefix to use to activate and deactivate call waiting. Since call waiting does not require these prefixes to be set, they are set as a default to 'None' and only used if values (such as *70 to deactivate). This will also appear in the Service management window under the Voice Service tab, but only if the service is SIP and Call Waiting is enabled. • On-No-Answer Timeout (secs) - This is used to calculate the Call forward on-no-answer ring count that is used on the iMG. The number of seconds is divided by 3 to get the ring count. The timeout in seconds that appears on the device details form (from the Voice Service tab) is calculated by multiplying the ring cadence by 3, and so may be different than what is in the profile. <p><i>Note: The attributes already have defaults filled in, and should not be changed unless for a specific reason. If the user tries to change these values and these are not allowed, the change will fail, and the user must look in the console file to review recent commands to find the failure (webserver: Conflict failure).</i></p>
Copy values from profile	To create a new profile, the user can select an existing profile, which will fill in the values from that existing profile. The user can then modify any fields.

TABLE 7-16 Create RG Voice Port Profile Form

Attribute	Value
Create	Activated when a Profile Name has been typed, it creates the profile with the entered values.
Cancel	Closes the window

FIGURE 7-28 Advanced Line Attributes - SIP (Arrows for 12.1 Features)

7.4.6 Business Group ID for SIP

The concept the Business Group ID for SIP is specific to Lucent and Sonus. To configure this ID, access the *iMG/RG -> Voice Service* Tab. If the user chooses the Voip Type as SIP, and then under Advanced VOIP Attributes chooses the iMG/RG Admin. Profile as Lucent or Sonus and clicks on Done, the New Line Configuration table will now include the Bus. Group ID. Refer to the following figure.

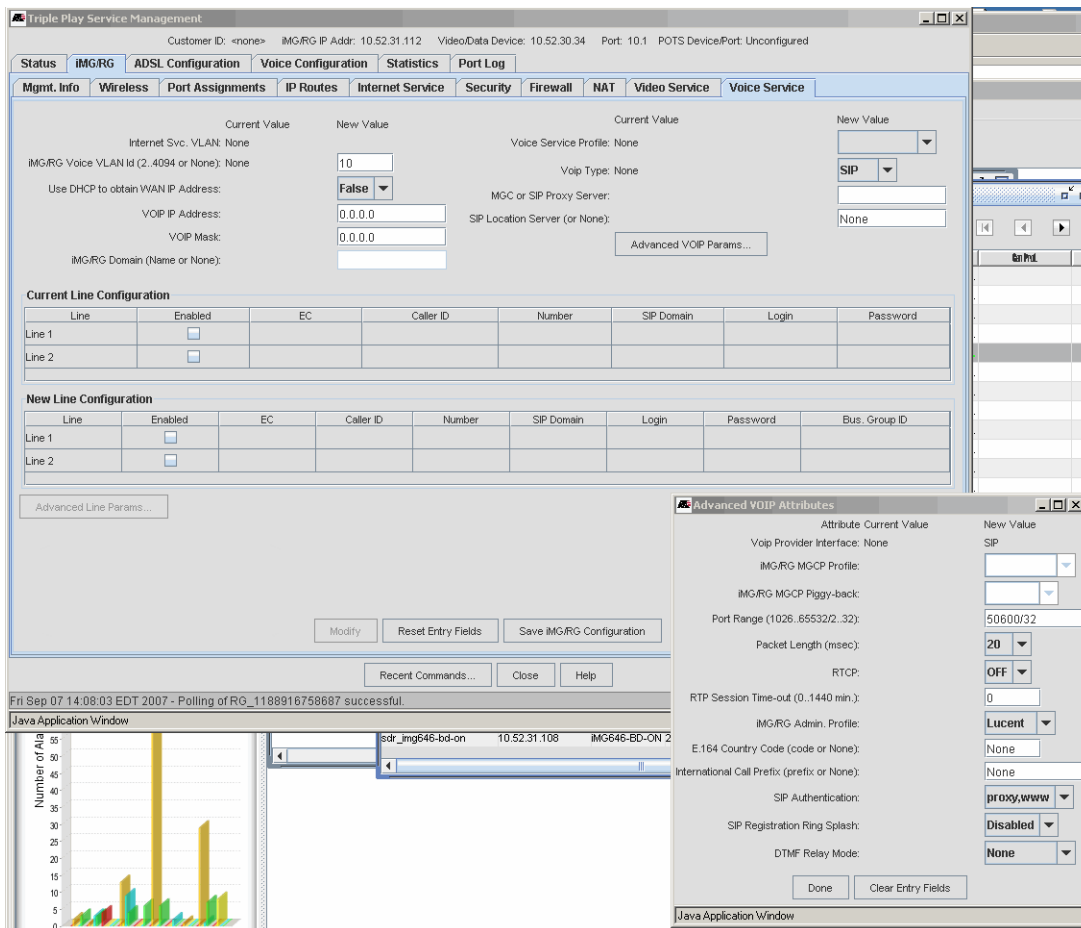

FIGURE 7-29 Setting the Business Group ID for SIP (Lucent of SONUS)

Note: If there is a SIP Voice Profile for SIP, with type Lucent of Sonus, the user could also choose a Voice Service Profile that matched (such as Profile SIP_SONUS), and the Bus. Group ID field would appear after selecting another tab and then re-selecting Voice Service to refresh the page.

7.5 Basic Configurations with Sample Profiles

7.5.1 Overview

The following descriptions isolate each service. In most cases services are bundled, but describing each service and its specific Profile(s) allows key fields/values to be highlighted.:

TABLE 7-17 Profile Set for Access Island 1

Service	Profile Types and Names	Description and Figure Reference
Customer Interface (iMAP)	7Mbps 11Mbps 15Mbps 100Mbps	Profile Name matches the speed required ADSL (1 STB and 3Mbps for data) ADSL (2 STB and 3Mbps for data) ADSL (3 STB and 3Mbps for data) Ethernet
Transparent LAN Service (TLS)	RG General= "Business_A"	7.5.2
Data (Internet)		
- Bridged	RG General= "DVLKND-AI01-IT_1I_2V" Internet = "Bridged Int Srv"	7.5.3
- Routed	RG General= "DVLKND-AI01-IT_1I_2V" Internet= "Routed Int Srv"	7.5.4
- Routed - NAT	RG General= "DVLKND-AI01-IT_1I_2V" Internet= "NAT Int Srv"	7.5.5
Video		
- Snooping	RG General= "Video_only" Video= "Snooping"	7.5.6
- Proxy	RG General= "Video_only" Video= "Flood" Video= "Snoop" Video= "Proxy"	7.5.7
Voice		
- MGCP		
- GBG6	RG General= "Voice_only" Voice= "RG-POTS-4Line"	7.5.8
- Nuera		Future
- ATI		Future
- SIP		
- SIP	Voice= "RG-POTS-4Line"	
- SIP - SONUS		Future

The following subsections include a figure that includes the main components involved in each type of RG service and their variants. Example profiles are then shown so that the user can understand the relationship between the service type and the values that are data filled in the profile.

7.5.2 Transparent LAN Service (TLS)

Most commonly, TLS is used to join two sites (usually of a business) through the upstream switches of the RGs. This is an Ethernet transport service, at layer 2. **Note that data must be untagged.** Refer to Figure 7-30.

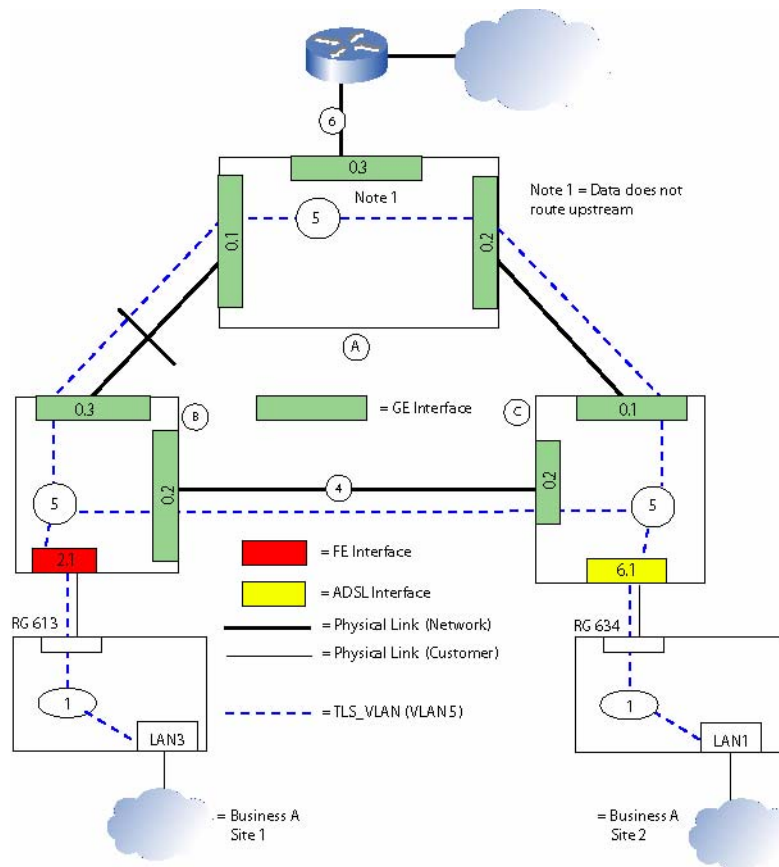

FIGURE 7-30 TLS Configuration

The following screen examples show the sample profiles included with the AlliedView NMS and what they contain

TABLE 7-18 Example Profiles for TLS

Profile Type	Example Profile Name	Description and Figure Reference
RG General Profile	DVLKND-AI01-TLS-only	In Mgmt. Info tab, no service VLANs are filled in. Can set Limited and Super User ID and password Can set pw only for Manager password (refer to Note after Table 7-7) Port Assignment tab has only one port filled, as TLS. (Figure 7-32) No IP routes required, but there should be a route to a back office management subnet.
RG Internet Profile	N/A	None (default)
RG Video Profile	N/A	None (default)
RG Voice Profile	N/A	None (default)

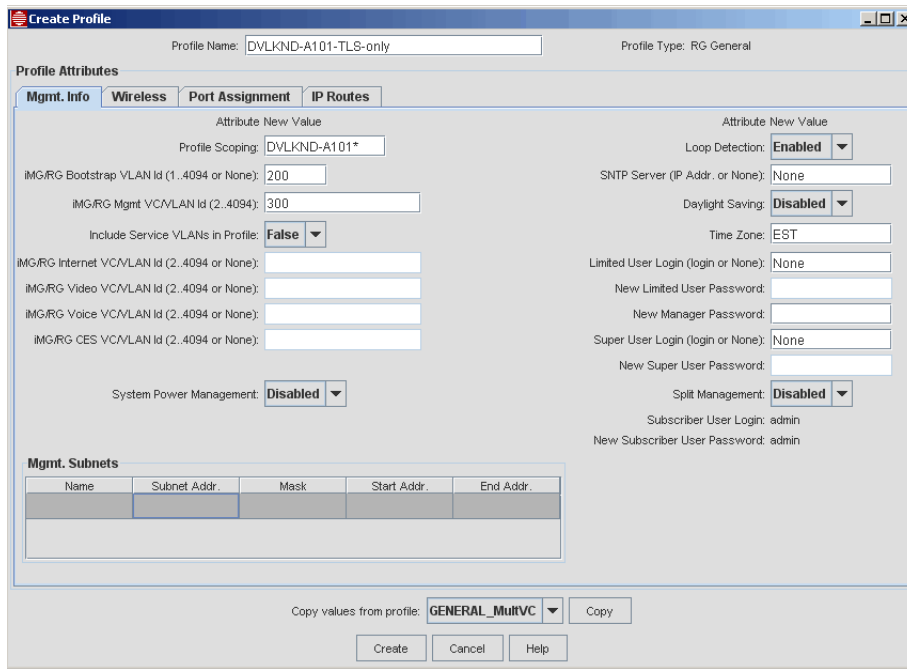

FIGURE 7-31 RG General Profile for TLS - Mgmt Info Tab

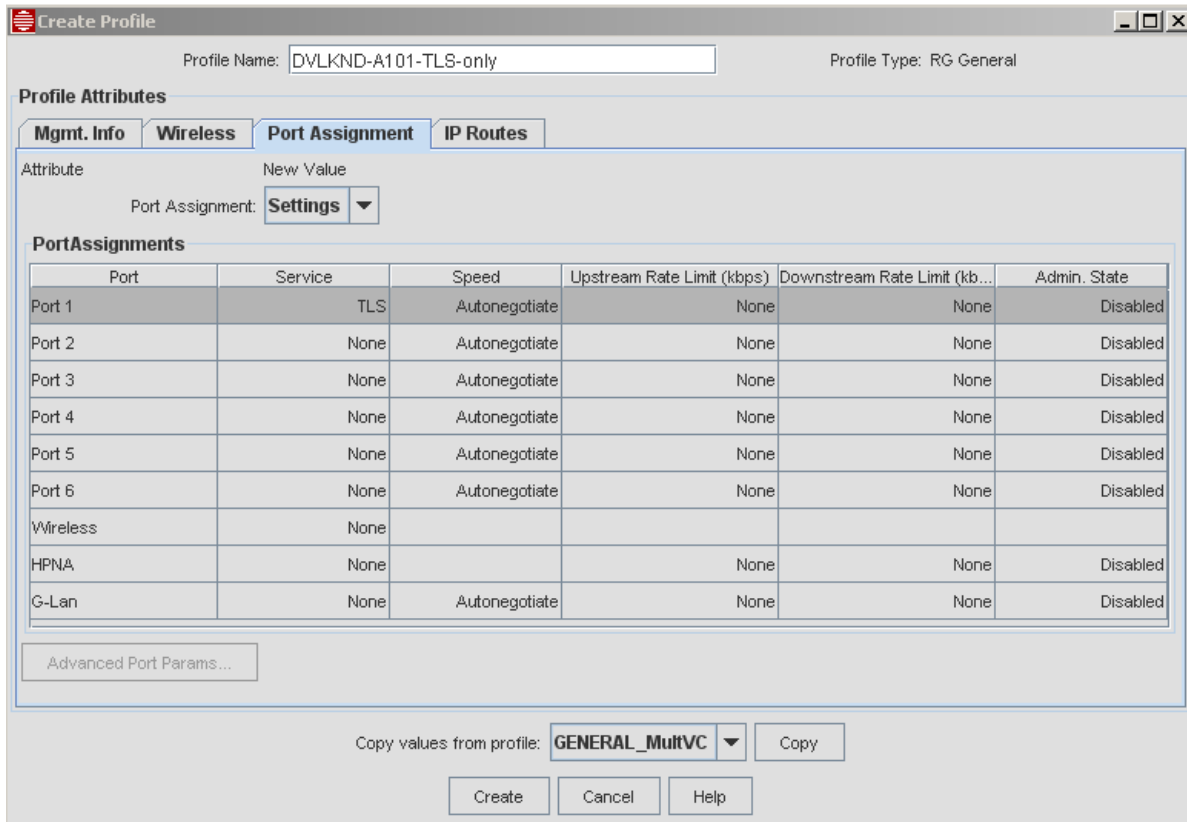

FIGURE 7-32 RG General Profile for TLS - Port Assignment Tab

7.5.3 Internet - Bridged

In Internet - Bridged service, a data device (such as a PC) connects with the ISP on the same VLAN, so there is no routing. In essence, the RG is like one end of a TLS connection. Refer to Figure 7-33.

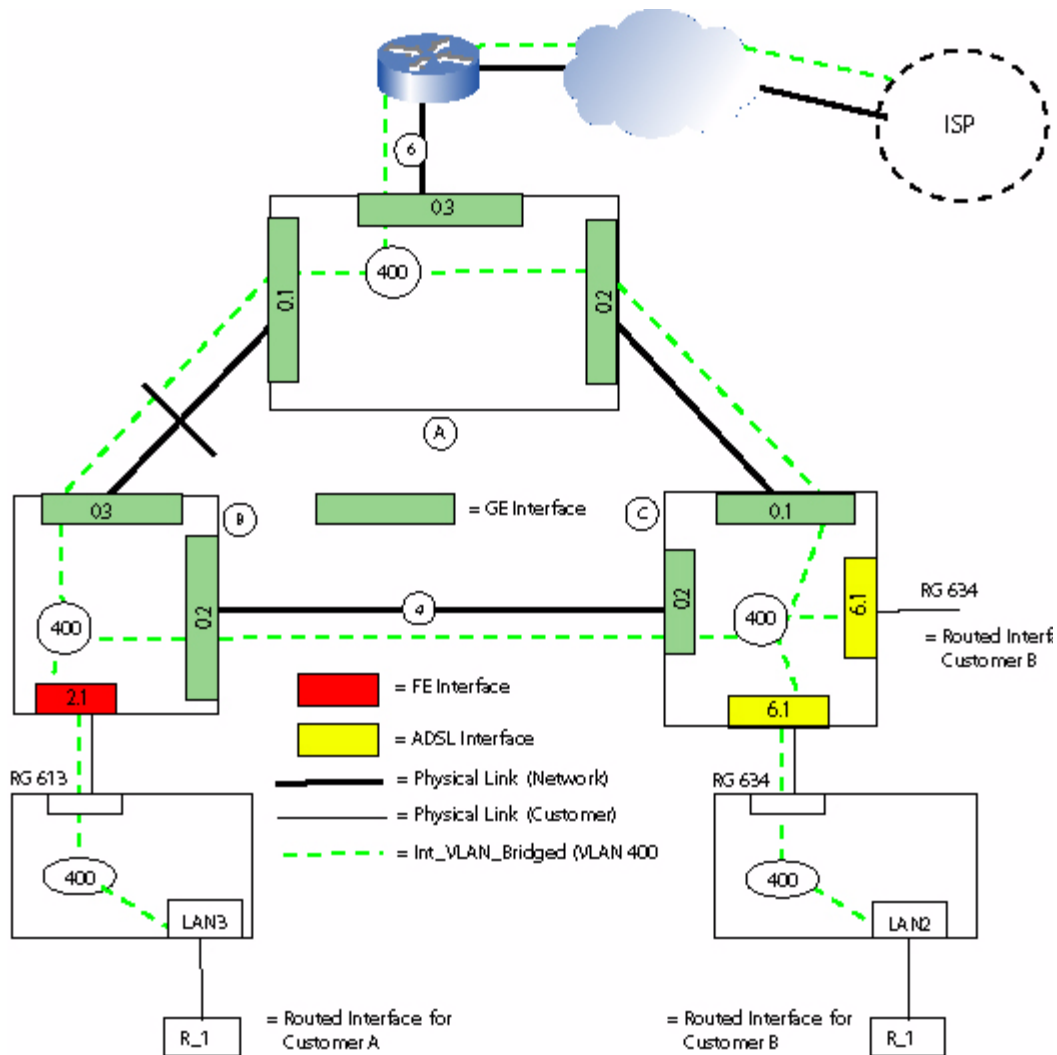

FIGURE 7-33 Internet - Bridged Configuration

The following table lists the sample profiles included with the AlliedView NMS and what they contain.

TABLE 7-19 Example Profiles for Internet - Bridged

Profile Type	Example Profile Name	Description
RG General Profile	“ Internet_only_bridged ”	In Mgmt. Info tab, Internet VLAN (400) filled in. Port Assignment tab has only one port filled, as Internet No IP Routes used
RG Internet	“ Bridged Service ”	Internet Service Type is Bridged Service No iMG/RG Local Customer VLAN

The screenshot shows a 'Create Profile' window with the following configuration details:

- Profile Name:** Bridged Service
- Profile Type:** RG Internet
- Profile Attributes:** General Internet Info, Security, Firewall, NAT
- Attribute New Value:**
 - Internet Service Type: Bridged Service
 - Include Internet VLAN in Profile: False
 - IMG/RG Internet VC/VLAN Id (2..4094):
 - Use PPPoE:
 - IMG/RG Local Customer VLAN Id (2..4094):
 - Use DHCP to obtain WAN IP Address: False
 - DNS Servers (list of IP Adrs. or None):
 - Local IP Address:
 - Local Mask:
 - Local DHCP Start IP Address:
 - Local DHCP End IP Address:
 - Rate Limiting: Disabled
 - Up. Rate Limit (1..50000 kbps):
 - Up. Burst Size (1..67108 bps):
 - Up. Scalar (1..100):
 - Down. Rate Limit (1..50000 kbps):
 - Down. Burst Size (1..67108 bps):
 - Down. Scalar (1..100):
- Copy values from profile:** [Dropdown] Copy
- Buttons:** Create, Cancel, Help

FIGURE 7-34 Internet Bridged Service - Profile “Bridged Service”

7.5.4 Internet - Routed

In Internet - Routed service, the RG has a routing function; there are two VLANs, one local to the RG and one for transport to the ISP. The RG IP address is included in packets from the data device. The DHCP function on the LAN side of the RG is included in the Triple Play form. Refer to Figure 7-35.

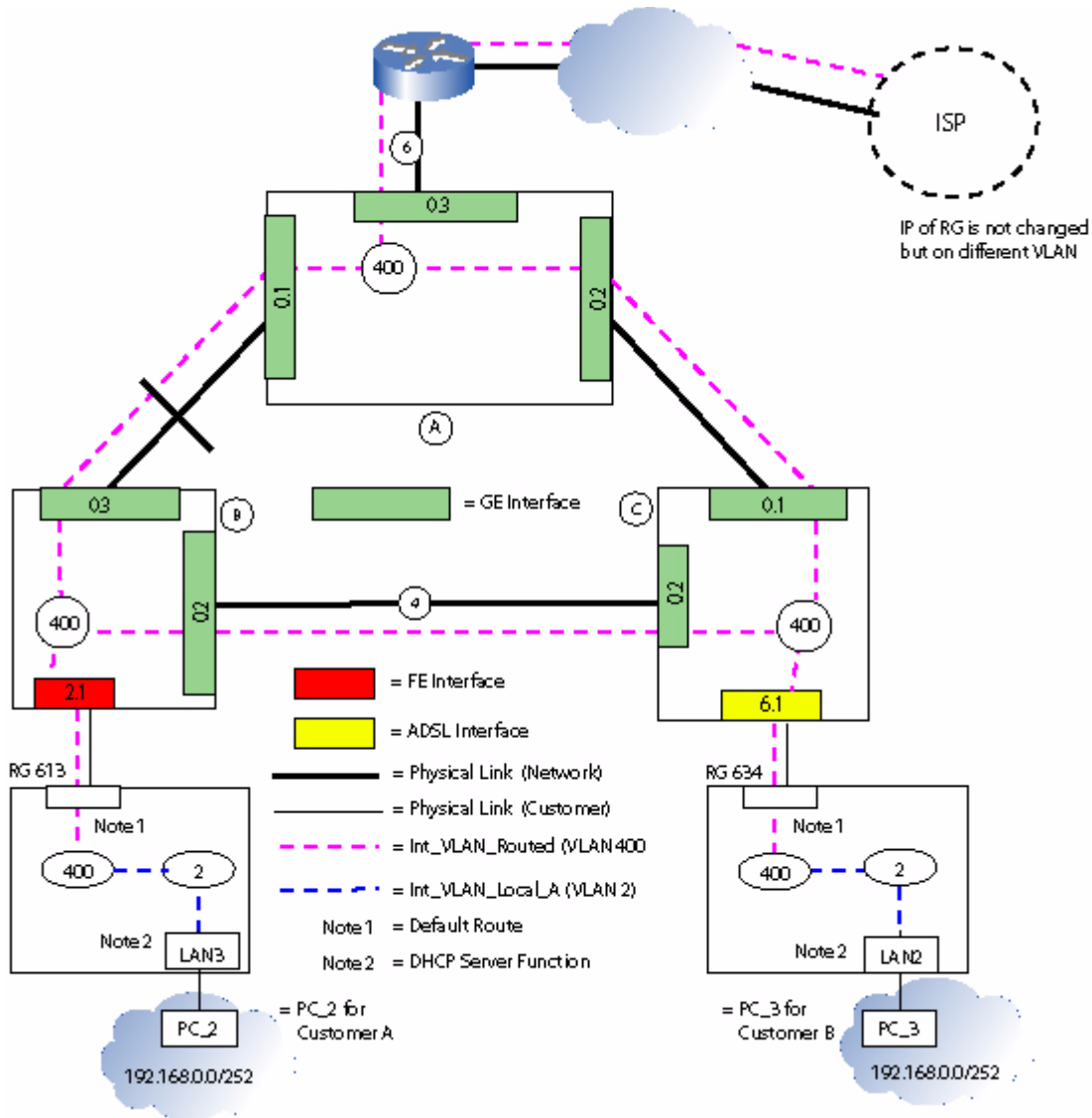

FIGURE 7-35 Internet - Routed Configuration

The following table lists the sample profiles included with the AlliedView NMS and what they contain.

TABLE 7-20 Example Profiles for Internet - Routed

Profile Type	Example Profile Name	Description
RG General Profile	"Internet_Routed_or_NAT"	In Mgmt. Info tab, Internet VLAN (400) filled in. Port Assignment tab has only one port filled, as Internet No IP routes used
RG Internet	"RoutedService"	Internet Service Type is Routed Service Need iMG/RG Local Customer VLAN - This must not be a VLAN also used to deliver services to the WAN port. DNS Servers - This will be used (take priority) only when DNS servers are not identified in the DHCP offer. Firewall should be disabled.

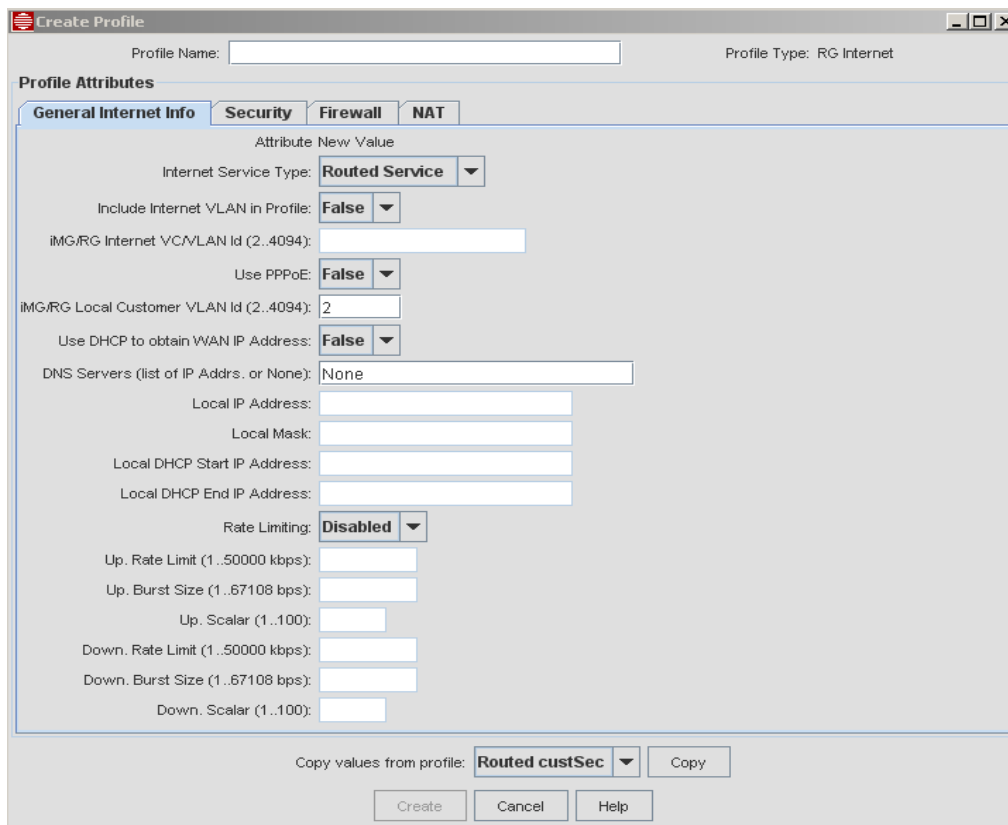

FIGURE 7-36 Internet Routed Service - Profile "Routed custSec" - General Tab

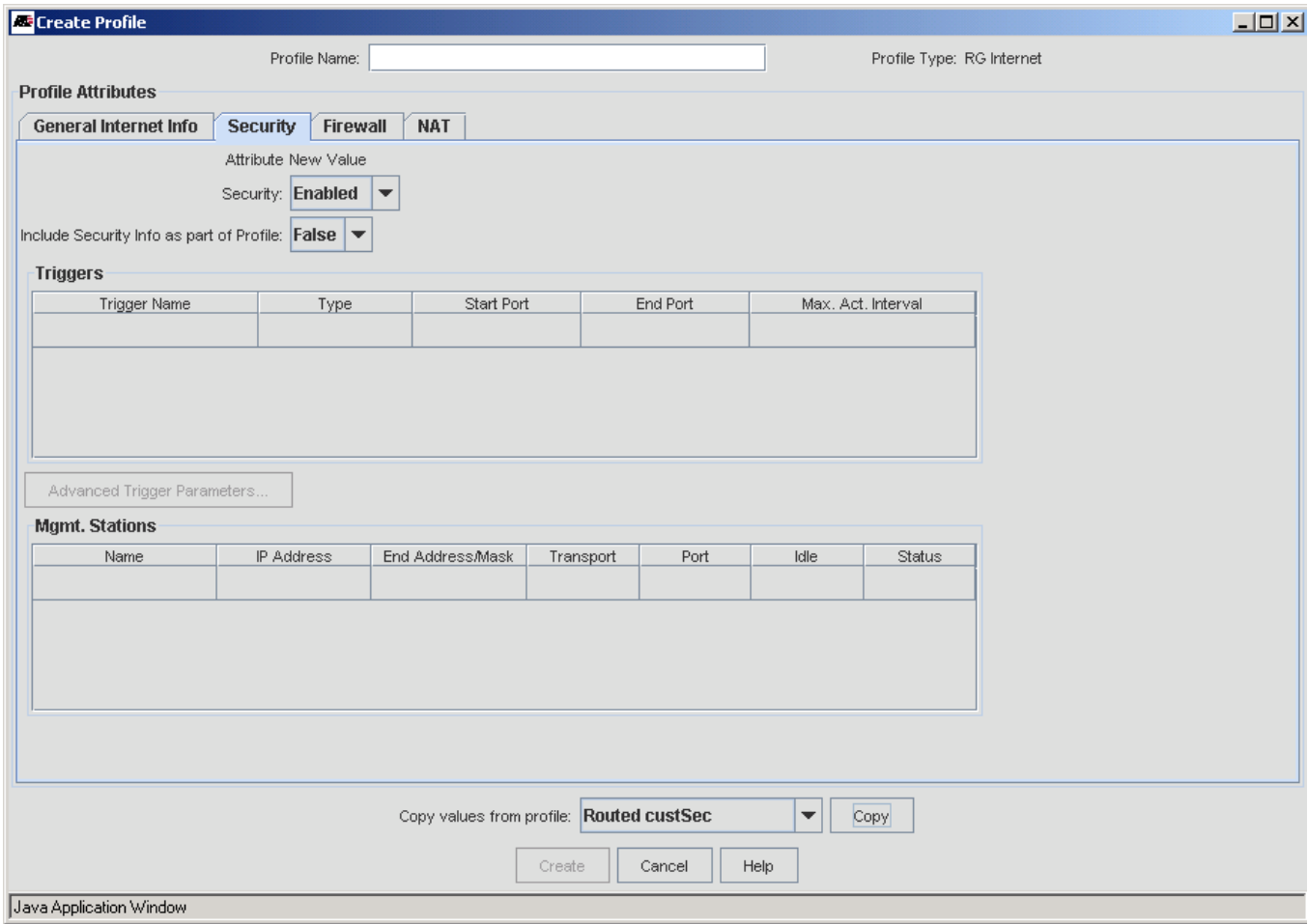

FIGURE 7-37 Internet Routed Service - Profile “Routed custSec” - Security Tab

7.5.5 Internet - Routed - NAT

In Internet - Routed NAT service is similar to the Routed service, with the key difference that IP numbering is local; the ISP sends packets to an RG IP address that is defined on a VLAN that is not local to the RG. A local VLAN is defined for the local IP numbering. Refer to Figure 7-38.

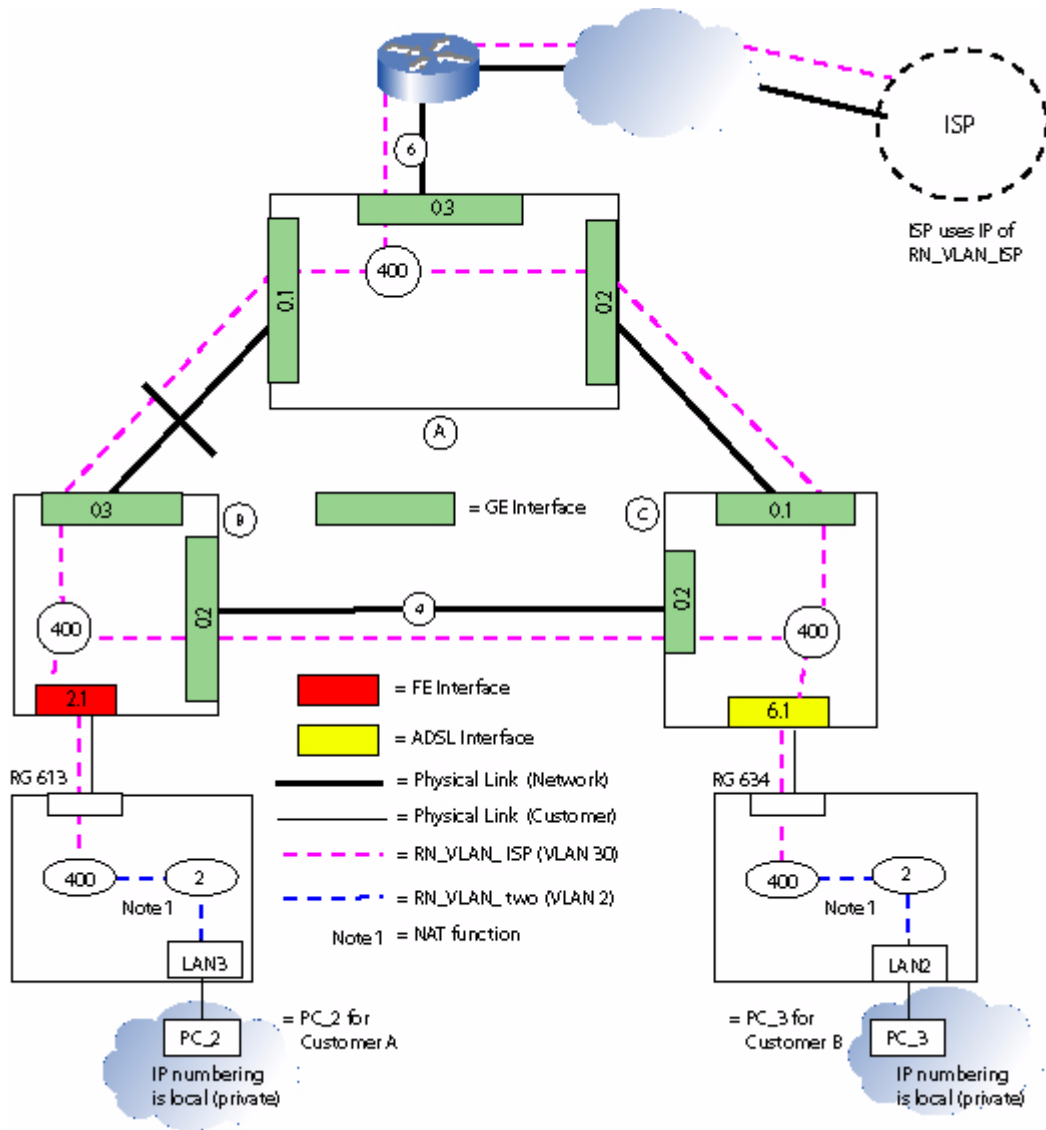

FIGURE 7-38 Internet - Routed NAT Configuration

The following table lists the sample profiles included with the AlliedView NMS and what they contain.

TABLE 7-21 Example Profiles for Internet - Routed - NAT

Profile Type	Example Profile Name	Description
RG General Profile	“Internet_Routed_or_NAT”	In Mgmt. Info tab, Internet VLAN (400) filled in. Port Assignment tab has only one port filled, as Internet No IP routes used
Routed Service NAT	“Routed/all security”	General Internet Info Tab - Internet Service Type is Routed Service - Need iMG/RG Local Customer VLAN Security Tab - Security Enabled - Security Info as part of Profile is True - Triggers and Mgmt. Stations set

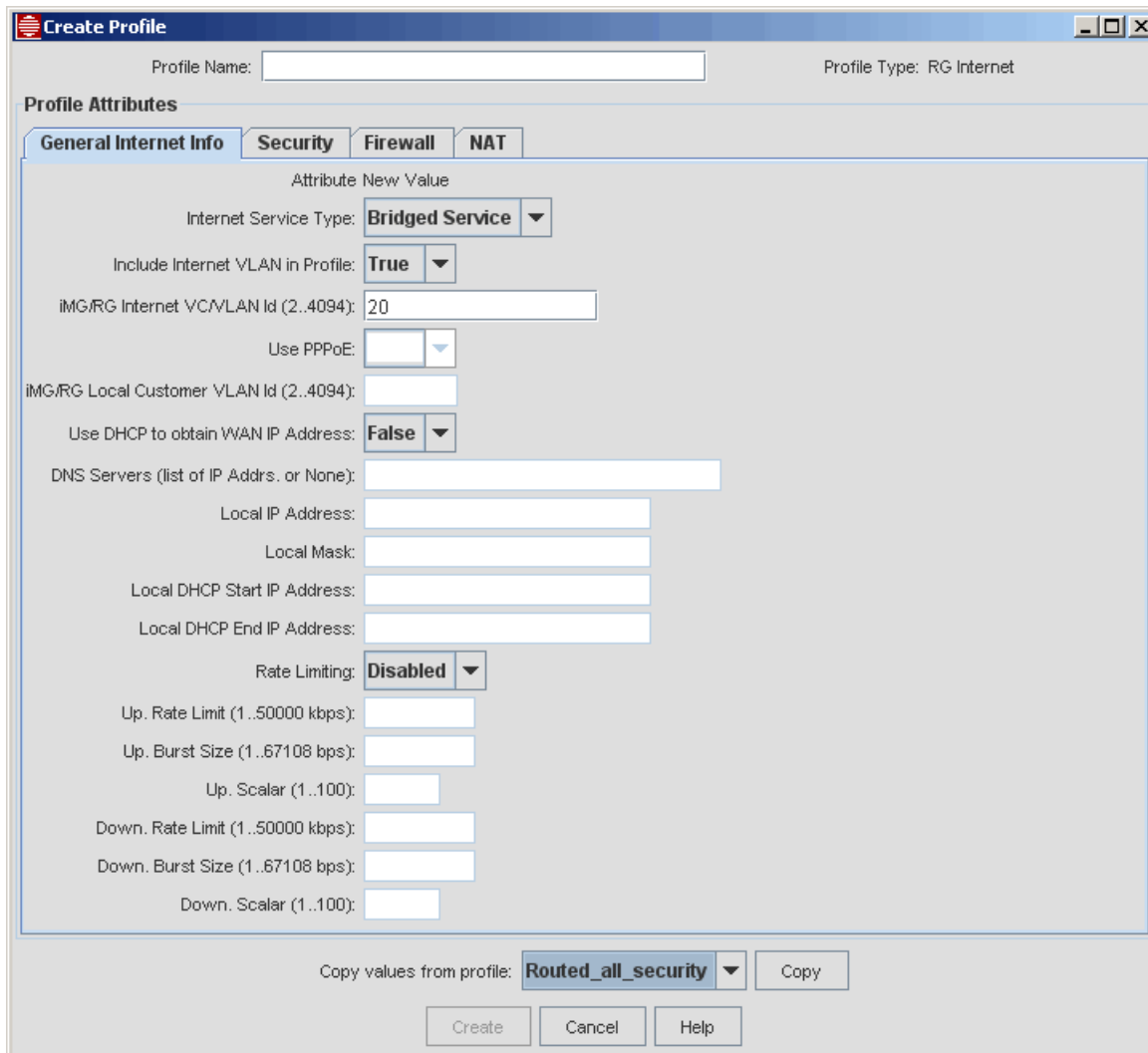

FIGURE 7-39 Internet Routed NAT Service - Profile “Routed/all security” - General Tab

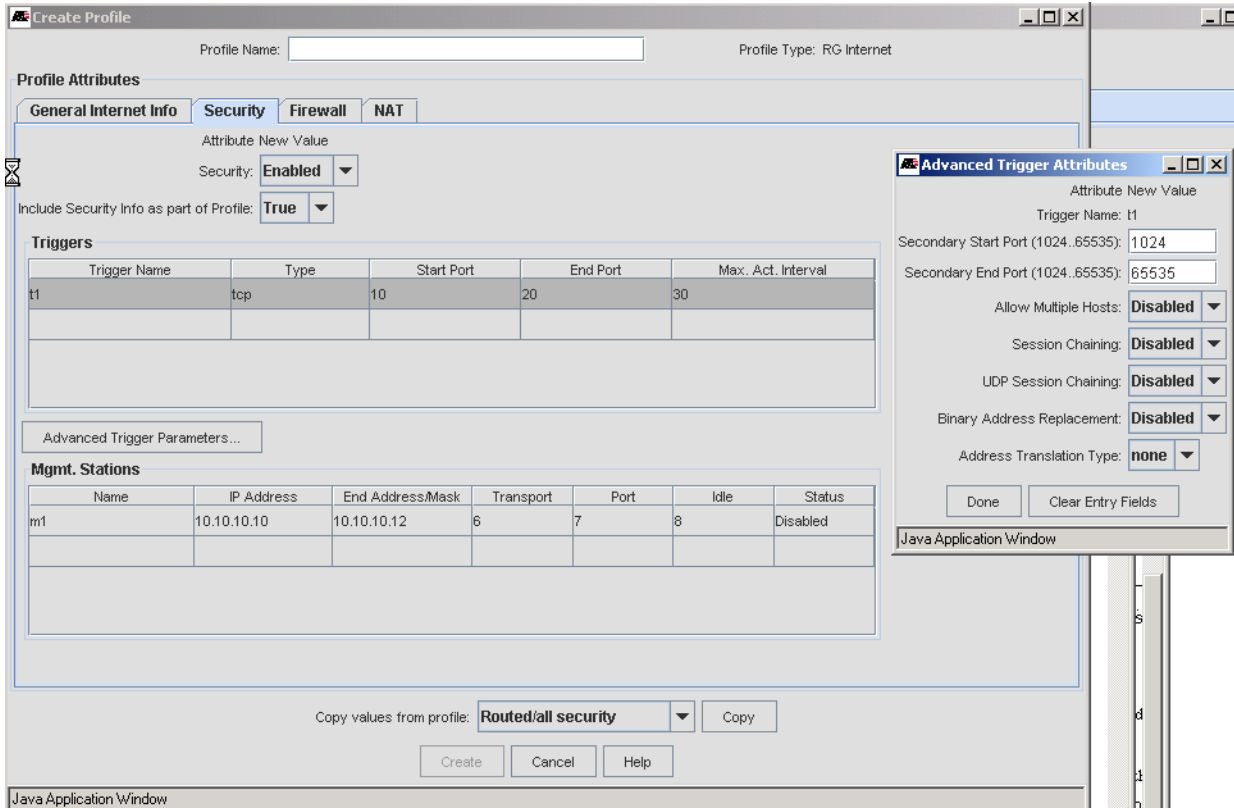

FIGURE 7-40 Internet Routed NAT Service - Profile “Routed/all security” - Security Tab

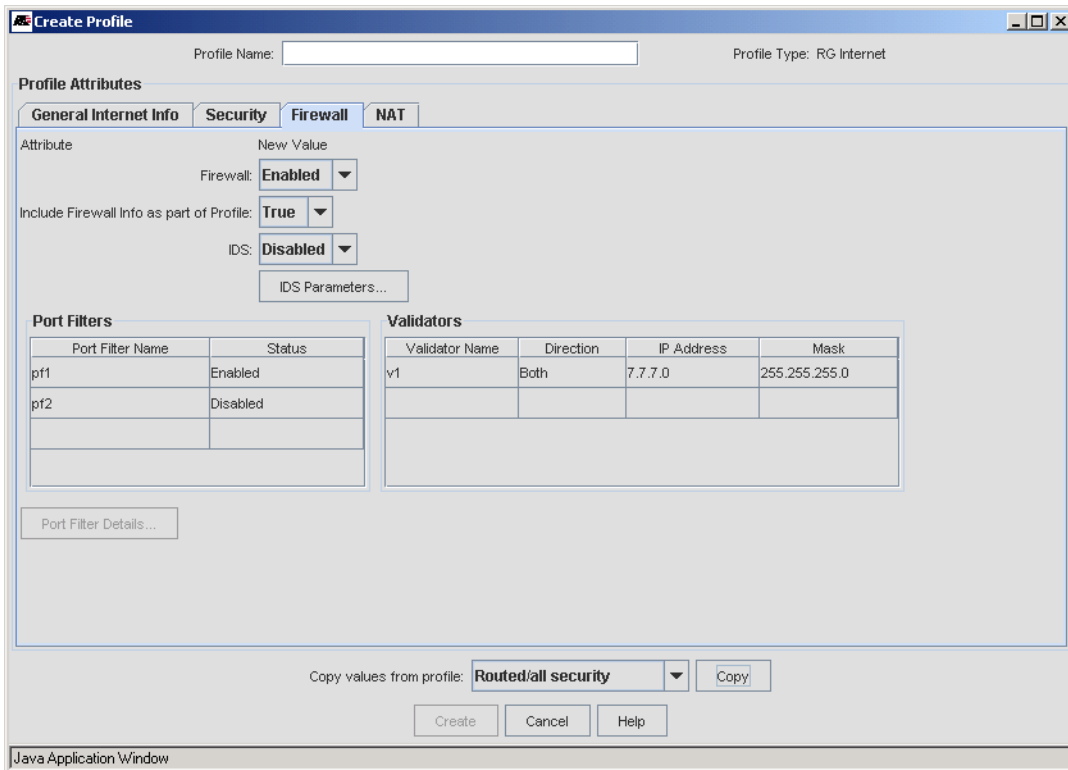

FIGURE 7-41 Internet Routed NAT Service - Profile “Routed/all security” - Security Tab

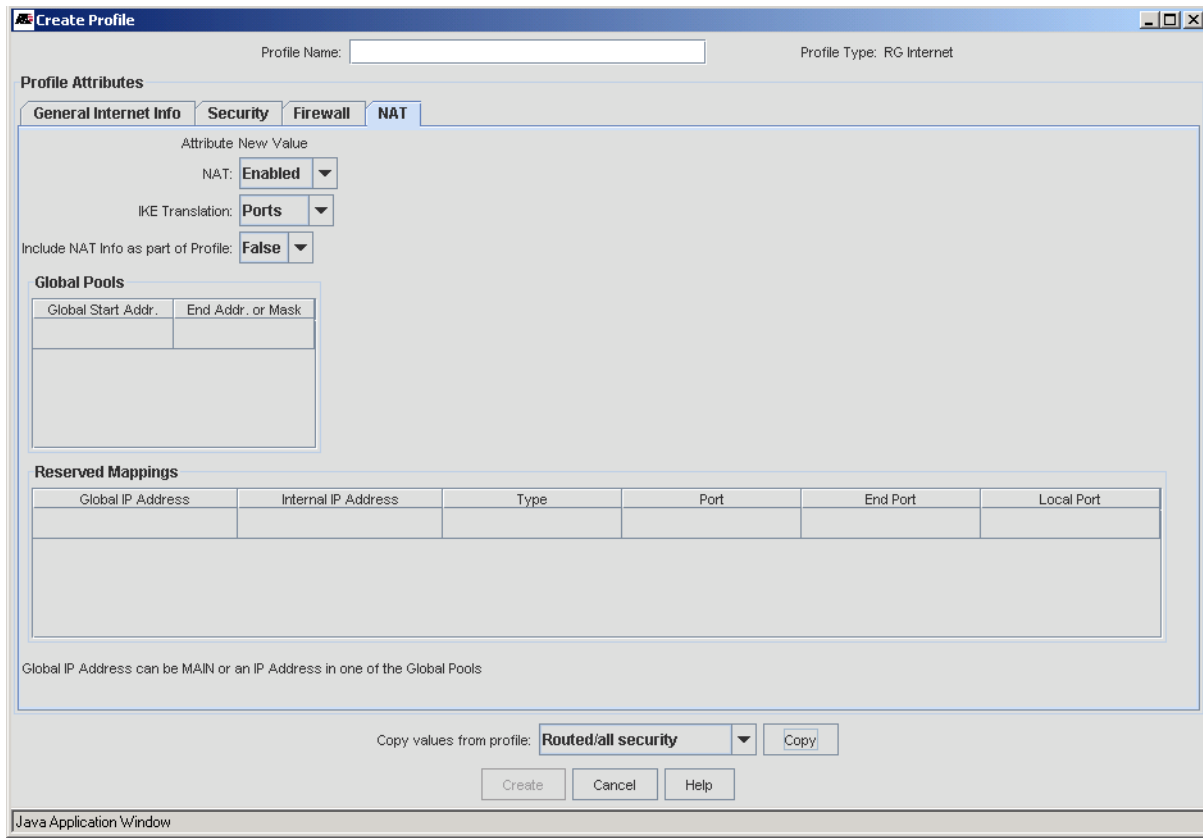

FIGURE 7-42 Internet Routed NAT Service - Profile “Routed/all security” - NAT Tab

7.5.6 Video - Snooping

In Video - Snooping service, the iMAP uses the STB/MAC locking feature, so the iMAP tracks the STB usage. IGMP is enabled in the iMAP so that it can track the joins/leaves via snooping.

Refer to Figure 7-39. Note that when video is set to NONE, all video streams go to all ports, so a 100 meg data stream must be used. With snooping, the STB only gets the video stream it is requesting, which helps prevent blocking. This is especially true when there are more than two STBs.

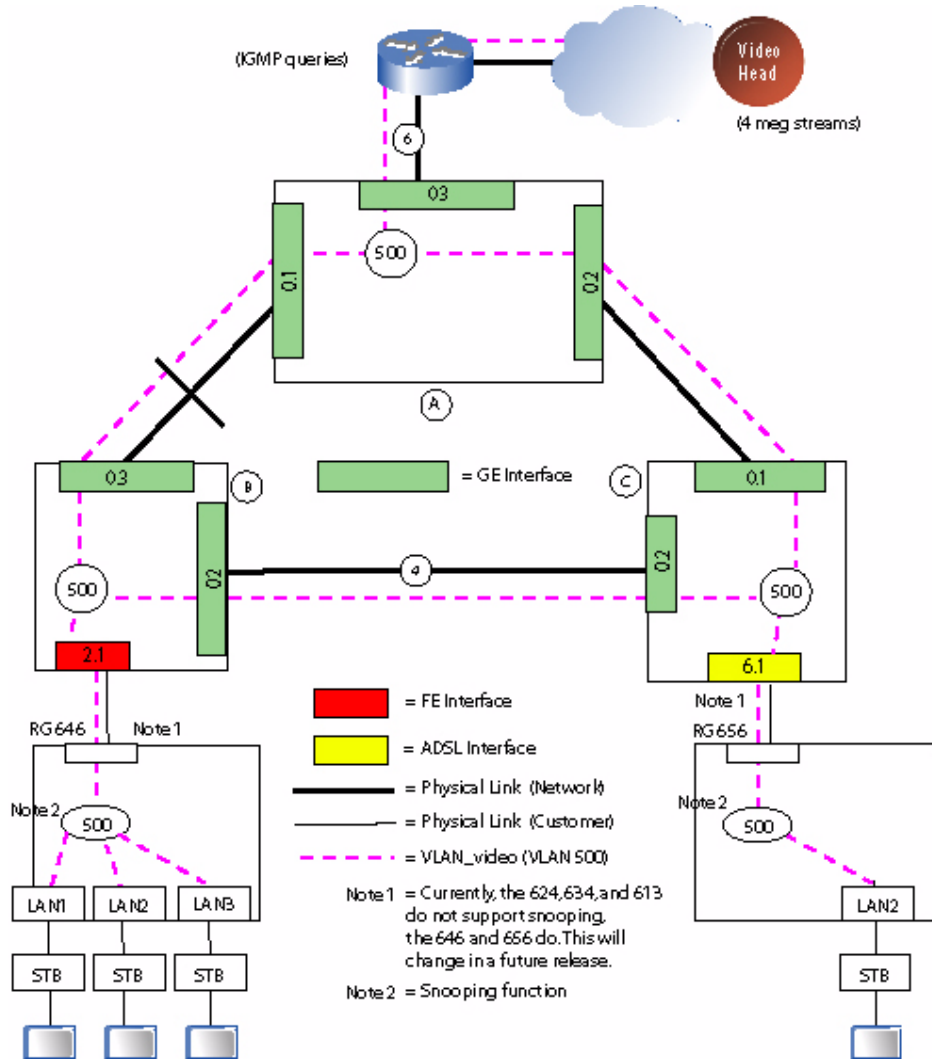

FIGURE 7-43 Video - Snooping Configuration

The following table lists the sample profiles included with the AlliedView NMS and what they contain.

TABLE 7-22 Example Profiles for Video - Snooping

Profile Type	Example Profile Name	Description
RG General Profile	“Video_only”	In Mgmt. Info tab, Video VLAN (500) filled in. Port Assignment tab has one or more ports filled, as Video IP Routes not used
RG Video	“Snooping”	IGMP Node is Snooping The IGMP time-out must be at least 10 seconds greater than the router queries, but not so much higher that it will time-out. IGMP Security, Autolearning, and Trusted Host Limit are currently valid for ADSL versions of RG only. Trusted Host Limit matches number of video ports used

Create Profile

Profile Name: Profile Type: RG Video

Profile Attributes

Attribute New Value

Include Video VLAN in Profile: **True** ▼

IMG/RG Video VC/VLAN Id (2..4094):

IGMP Mode: **Snooping** ▼

IGMP Timeout (1..65535 seconds):

IGMP Leave Time:

IGMP Security: **Disabled** ▼

IGMP Security Autolearning: **Disabled** ▼

Trusted Host Limit (1..6):

IGMP Default Fast Leave: **Enabled** ▼

Copy values from profile: ▼

FIGURE 7-44 Video Snooping Service - Profile “Snooping”

7.5.7 Video - Proxy

In Video - Proxy service, the joins/leaves are performed by the RG and so IGMP is disabled on the iMAP. The iMAP supports eight Multicast groups per MAC (up to six). With proxy, the iMAP sees only one MAC, that of the RG, and up to eight MC groups. Refer to Figure 7-45.

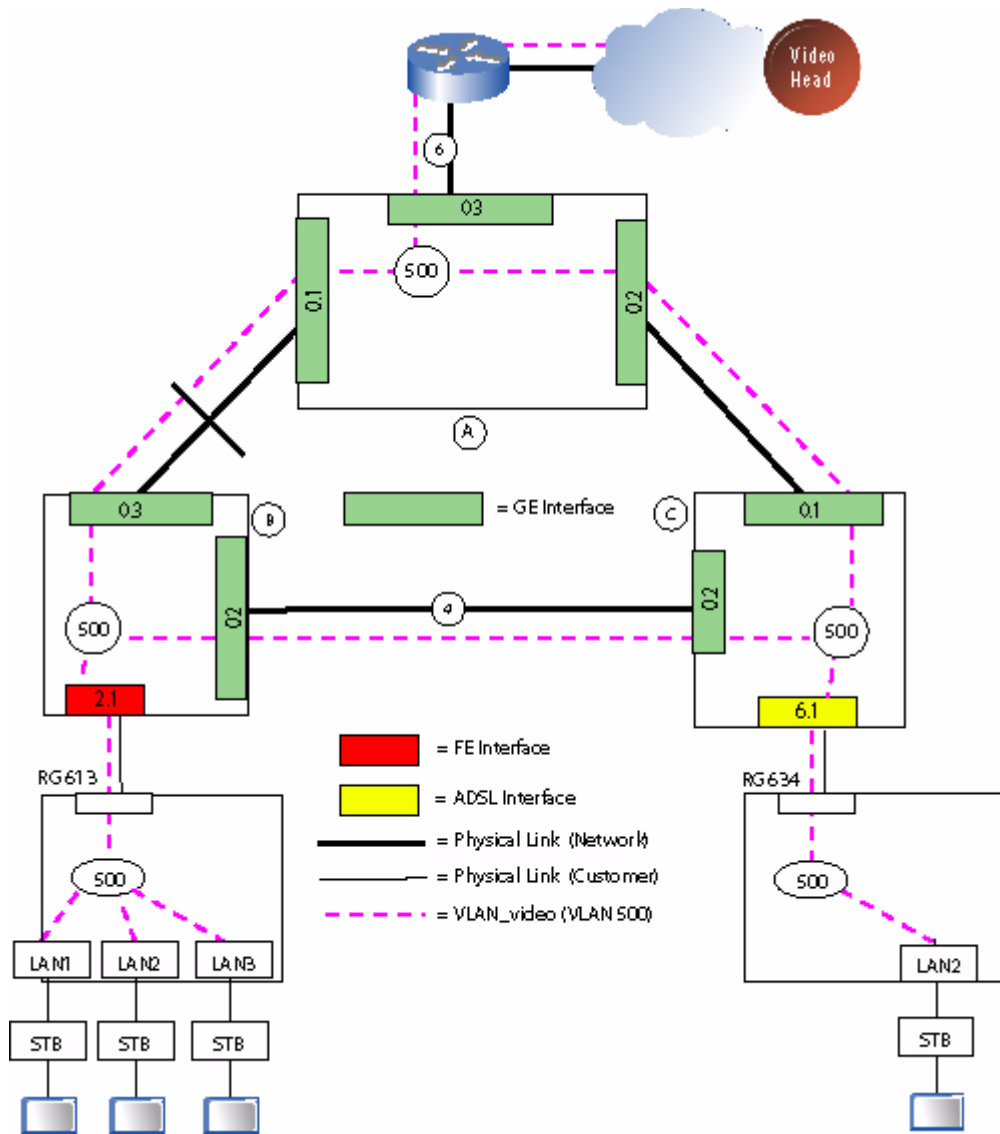

FIGURE 7-45 Video - Proxy Configuration

The following table lists the sample profiles included with the AlliedView NMS and what they contain.

TABLE 7-23 Example Profiles for Video - Proxy

Profile Type	Example Profile Name	Description
RG General Profile	“Video_only”	In Mgmt. Info tab, Video VLAN (500) filled in. Port Assignment tab has one or more ports filled, as Video IP Routes tab has no entries.
RG Video	“Proxy” (These are for ADSL only) <ul style="list-style-type: none"> • ManualSec2/Proxy • ManualSec3/Proxy • AutoSec2/Proxy • AutoSec3/Proxy 	IGMP Node is Proxy For the others, trusted Host Limit should match number of video ports used

The screenshot shows the 'Create Profile' dialog box with the following configuration:

- Profile Name: Proxy
- Profile Type: RG Video
- Attribute New Value:
 - Include Video VLAN in Profile: True
 - iMG/RG Video VC/VLAN Id (2..4094): 40
 - IGMP Mode: Proxy
 - IGMP Timeout (1..65535 seconds): 250
 - IGMP Leave Time: 5
 - IGMP Security: Disabled
 - IGMP Security Autolearning: Enabled
 - Trusted Host Limit (1..6): 4
 - IGMP Default Fast Leave: Enabled
- Copy values from profile: VideoProxy
- Buttons: Create, Cancel, Help

FIGURE 7-46 Video Proxy Service - Profile “Proxy”

7.5.8 Voice - Public and Private

For voice service, a major choice is whether to include voice service on an internet VLAN (Public) or to use a separate VLAN for voice (Private). This choice, as well as whether IP addresses will be allocated statically or dynamically, are attributes for each type of Voice service. Moreover, each of these services is on an RG basis; the specific service types cannot be shared on the same RG. (In most cases, an ISP has one main strategy for providing voice service and so applies the same service to all RGs.) Refer to Figure 7-47.

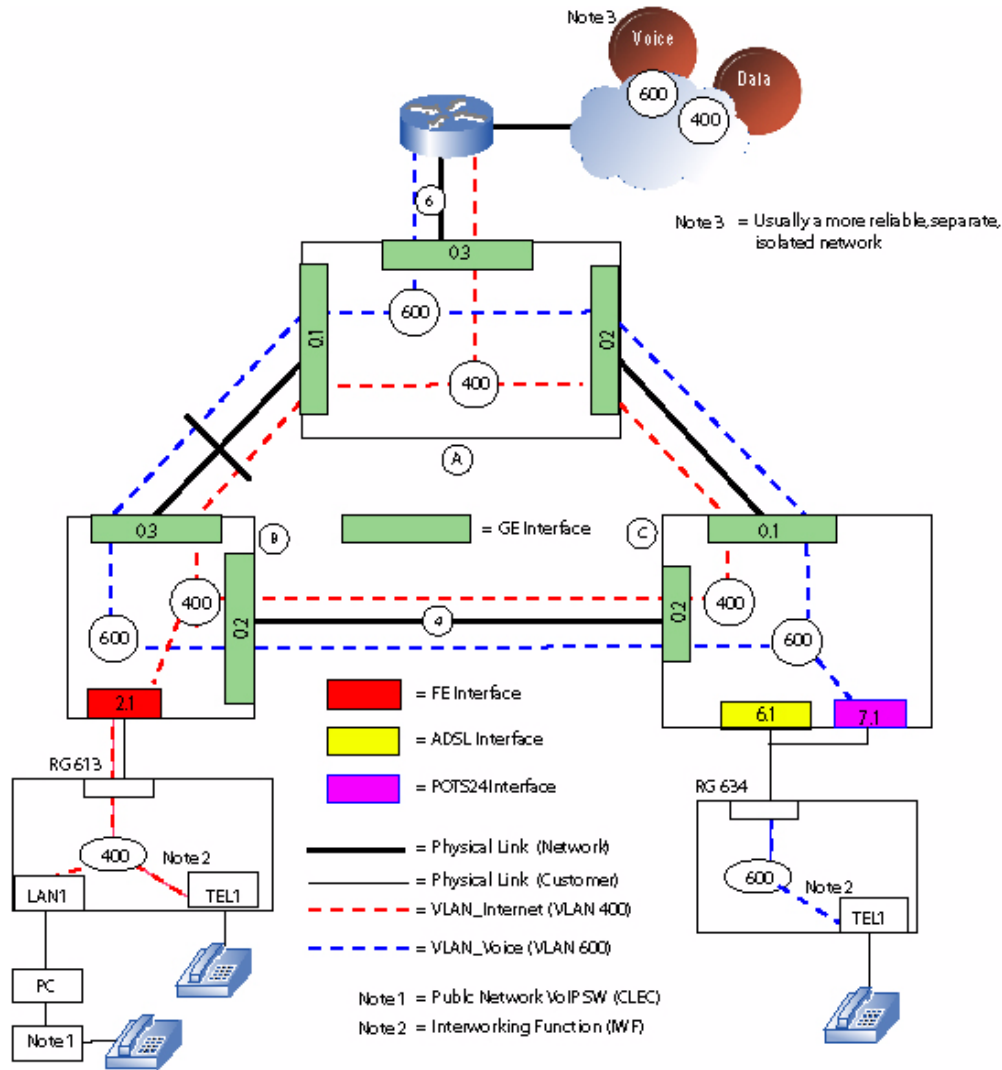

FIGURE 7-47 Voice - Public and Private Configuration

The following table lists the sample profiles included with the AlliedView NMS and what they contain.

TABLE 7-24 Example Profiles for Voice

Profile Type	Example Profile Name	Description
RG General Profile	“Voice_only”	In Mgmt. Info tab, Voice VLAN (600) filled in. Port Assignment tab has no ports datafilled. IP Routes tab has Route 1 enabled, and then subnet and subnet mask of Media Gateway Controller, and Gateway address that connects to the Media Gateway Controller
RG Voice	“RG-POTS-4Line”	Profile Scoping is None VOIP Type is MGCP GBG6 Service path is Private Path, since a separate Voice VLAN iMG/RG Domain used in voip subnet configuration. Refer to 7.2.6.4.
	“SIP1”	This provides most of the attributes for the SIP configuration. Note that there is the “Advanced Line Params” where additional parameters are entered. This button is activated when at least one of the lines is Enabled.

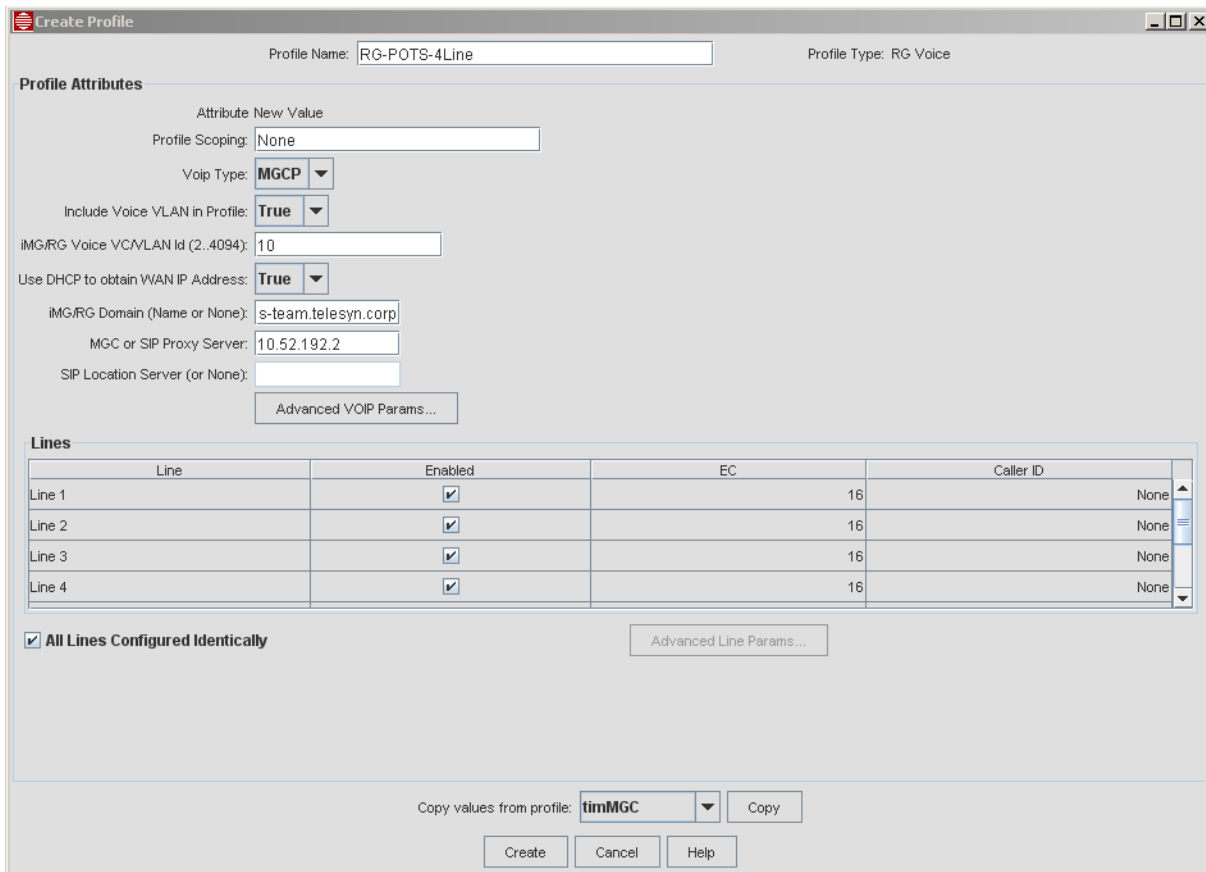

FIGURE 7-48 Voice Service - Profile “RG-POTS-4Line”

The screenshot shows two overlapping configuration windows. The 'Create Profile' window is in the foreground, and the 'Advanced VOIP Attributes' window is in the background.

Create Profile Window:

- Profile Name: SIP1
- Profile Attributes:
 - Attribute New Value: (empty)
 - Profile Scoping: None
 - Voip Type: SIP
 - Include Voice VLAN in Profile: True
 - IMG/RG Voice VCA/VLAN Id (2..4094): 10
 - Use DHCP to obtain WAN IP Address: True
 - IMG/RG Domain (Name or None): (empty)
 - MGC or SIP Proxy Server: 192.52.192.3
 - SIP Location Server (or None): None
 - Advanced VOIP Params... (button)
- Lines Table:

Line	Enabled	EC	Caller ID
Line 1	<input checked="" type="checkbox"/>		16
Line 2	<input checked="" type="checkbox"/>		16
Line 3	<input checked="" type="checkbox"/>		16
Line 4	<input checked="" type="checkbox"/>		16
- All Lines Configured Identically
- Advanced Line Params... (button)
- Copy values from profile: timSIP (dropdown) Copy (button)
- Create, Cancel, Help (buttons)

Advanced VOIP Attributes Window:

- Attribute New Value: (empty)
- Voip Provider Interface: SIP
- IMG/RG MGCP Profile: (dropdown)
- IMG/RG MGCP Piggy-back: (dropdown)
- LCFO: Enabled
- Port Range (1026..65532/2..32): 50600/32
- Packet Length (msec): 20
- RTCP: OFF
- RTP Session Time-out (0..1440 min.): 0
- IMG/RG Admin. Profile: None
- E.164 Country Code (code or None): None
- International Call Prefix (prefix or None): None
- SIP Authentication: proxy,www
- SIP Registration Ring Splash: Disabled
- SIP Subscriber Event Message Summary: Disabled
- DTMF Relay Mode: Auto
- Done, Clear Entry Fields (buttons)

FIGURE 7-49 RG Voice Profile - "SIP1"

7.5.9 ADSL iMG with multiple VCs

The user can provision the iMG/RG General Profile and ADSL Port Profile so that the ADSL-based iMG/RG can support service VLANs with different VC configurations. The format used to specify a specific VLAN/VC combination is <vlanid>vc:<vpi>.<vci>:<tagged or untagged>. In the following figure, the RG General Profile has the internet VLAN configured on a different VC with VPI=0 and VCI=36. An ADSL port profile is then created to match that setting, as well as the transmit rates.

The figure consists of two screenshots of the 'Create Profile' configuration window. The top screenshot is for a 'RG General' profile. It shows various configuration options under tabs like 'Mgmt. Info', 'Wireless', 'Port Assignment', and 'IP Routes'. Key settings include 'Profile Scoping: None', 'Loop Detection: Disabled', and 'System Power Management: Disabled'. A table for 'Mgmt. Subnets' is also visible. The bottom screenshot is for an 'ADSL' profile. It shows tabs for 'General', 'Rate Settings', 'VC/VLAN info', 'STP', and 'ADSL Thresholds'. The 'VC/VLAN info' tab contains a table for configuring VCs and VLANs.

VC	Exists	VPI	VCI	Untagged VLAN ID	Tagged VLAN IDs	Transmit PCR
0	<input checked="" type="checkbox"/>	0	35	1	7,10,40	MAX
1	<input checked="" type="checkbox"/>	0	36	20		3000
2	<input type="checkbox"/>					
3	<input type="checkbox"/>					

FIGURE 7-50 The RG General and ADSL Port Profile to Support VLAN/VC Configuration

When the user then fills out the Triple-Play form for the ADSL-based iMG/RG, and uses these profiles, the VLAN/VC settings will be set immediately on the iMAP, and on the iMG/RG when it placed into service (connected and powered on). The following figure shows a Triple-Play form that uses the profiles that will have the iMG/RG come up with the internet VLAN having a different VC and transmit rate, as shown in Figure 7-50.

Note: *The attributes on the iMG/RG General Profile, Port Profile, and Service Profile must match. Otherwise, when the user fills out and submits the Triple Play form, it will fail with the error message that the profiles don't match. (If these profiles were to be applied, traffic would not pass on the internet VLAN.) This is shown next.*

Provision New Triple Play Customer

Description (Customer ID):

iMG/RG General Configuration

iMG/RG General Profile:

Video/Data Configuration

Access Device: Slot Port: (ADSL) (ADSL)

Allowed IP Addr. Ranges: IP Addr/# Bits (e.g. 192.4.1.0/24)

Range #1: Range #2: Range #3:
 Range #4: Range #5: Range #6:

Data Svcs. Config: Internet Svc. Profile:

Video Service Config: Video Svc. Profile:

Allowed STB MAC Addr:

STB #1: STB #2: STB #3:
 STB #4: STB #5: STB #6:

Voice Configuration

POTS: Access Device: Slot Port: POTS Port Profile:

POTS Call Agent: Line Profile: Interface Group: CRV:

Derived Voice: Derived Voice Svc. Profile:

CPE GenBand Configuration:

Port #1: Line Profile: Interface Group: CRV:

Schedule

Java Application Window

FIGURE 7-51 Triple Play Form with Profiles to Configure VLAN/VC for Internet Service

The user also must be aware that when provisioning an ADSL iMG/RG, the profiles must be aligned so that the services can be provisioned. The main guidelines are:

- When specifying the VC in an iMG/RG profile, and the profile is applied to a non-DSL iMG/RG, the VPI, VCI, and Framing attributes are ignored.
- If the user fills out the Triple-Play form and uses profiles that do not match up with each other for VLAN/service configuration, the NMS will not allow the subscriber to be provisioned and will display an error message. Refer to the following figure.

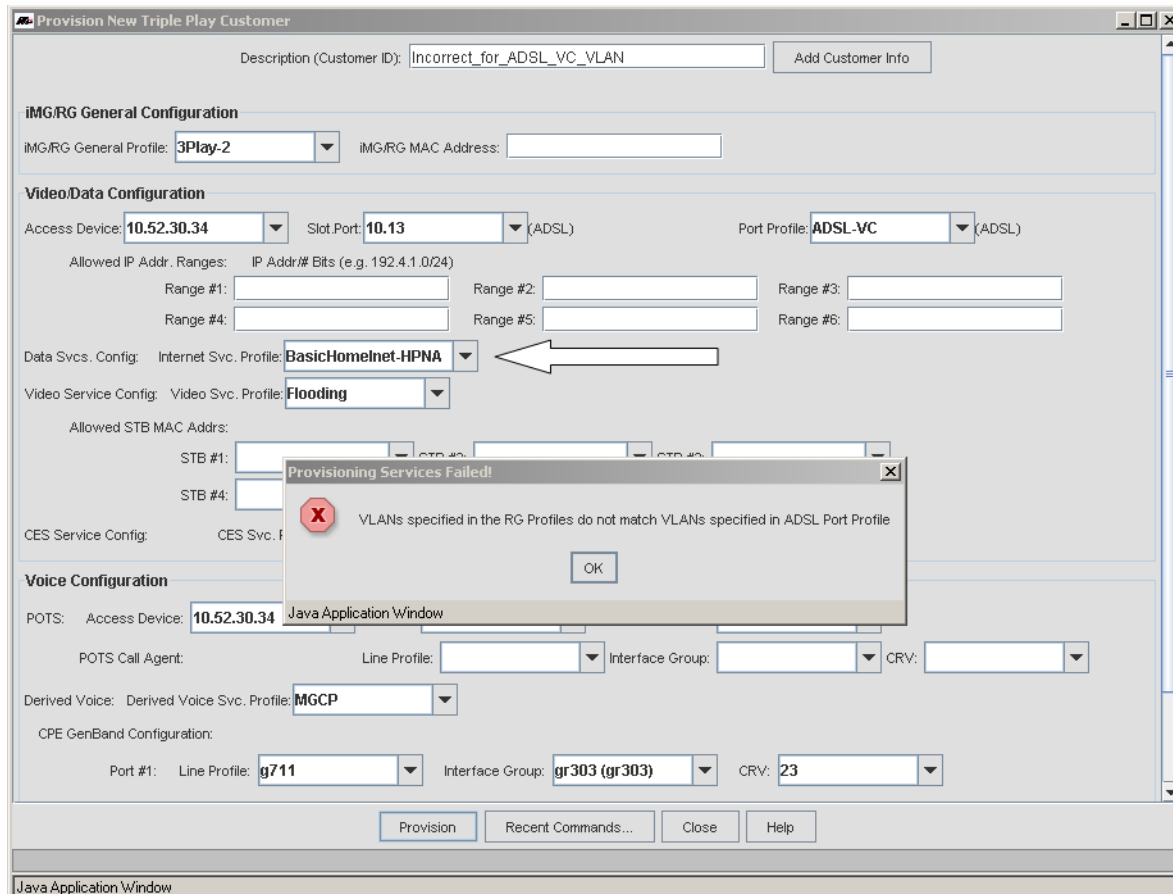

FIGURE 7-52 Provisioning Error for DSL-based iMG/RG

Once the iMG/RG is provisioned and in service, the user has the option to change the settings in the Triple Play Service Management window. Moreover, once this is updated, the NMS will update the iMAP port configuration if necessary.

In the following figure, the user has decided to change the internet VLAN so that it is on VLAN 21 (rather than 20), and has VPI=1, VCI=45. The user can go to the Service Management window and in the *iMG/RG->Internet Service* tab change the iMG/RG Internet VC/VLAN to 21 VC:1.45:Tagged. Refer to the following figure.

Note: The user should avoid making changes on the Service Management Form when possible, since if the value entered here is different than what is in the iMG/RG General or Service Profile, the device will be marked as out-of-sync.

The screenshot displays the configuration interface for an iMG/RG device. The top navigation bar includes tabs for Status, iMG/RG, Ether-like Configuration, Voice Configuration, Statistics, and Port Log. Below this, a secondary set of tabs includes Mgmt. Info, Port Assignments, IP Routes, Internet Service (selected), Security, Firewall, NAT, Video Service, Voice Service, CES Service, and Diagnostics. The main configuration area is divided into two columns: 'Current Value' and 'New Value'. The 'iMG/RG Internet VC/VLAN' field is the focus, with a white arrow pointing to the 'New Value' input box containing '21 VC:1.45:Tagged'. Other fields include 'Internet Service Profile' (None), 'Internet Service Type' (Routed Service), 'Use PPPoE' (False), 'PPPoE User Name', 'PPPoE Password', 'TCP MSS Clamp' (Disabled), 'Internet MTU' (1500), 'iMG/RG Local Customer VLAN ID' (2), 'Use DHCP to obtain WAN IP Address' (True), 'DNS Servers', 'Internet IP Address' (10.52.31.212), 'Internet Mask' (255.255.255.224), 'Local IP Address' (192.168.1.6), 'Local Mask' (255.255.255.0), 'Local DHCP Start IP Address' (192.168.1.10), and 'Local DHCP End IP Address' (192.168.1.20). At the bottom, there are buttons for 'Modify', 'Clear Entry Fields', 'Save iMG/RG Configuration', 'Recent Commands...', 'Close', and 'Help'. A status bar at the very bottom indicates 'Tue Jul 19 13:50:18 EDT 2011 - Polling of RG_1305141805578 successful.'

FIGURE 7-53 Changing an existing VLAN/VC Configuration

After choosing Save iMG/RG Configuration, the user will see that the NMS will make the necessary changes, and in the *ADSL Configuration -> VCs/VLANs* tab the changes are reflected. Refer to the following figure.

Triple Play Service Management

Customer ID: MemTest2 iMG/RG IP Addr: 10.52.31.105 Video/Data Device: 10.52.30.34 Port: 10.4 POTS Device/Port: Unconfigured

Status iMG/RG ADSL Configuration Voice Configuration Statistics Port Log

General VCs/VLANs Video DHCP FDB PMON Thresholds RMON Thresholds Device Data Coll. IP Filters Diagnostics

Current VC Configuration

VC	Exists	VPI	VCI	Untagged VLAN ID	Tagged VLAN IDs	Transmit PCR
0	<input checked="" type="checkbox"/>	0	35		7,10,40	65536
1	<input type="checkbox"/>					
2	<input checked="" type="checkbox"/>	1	45		21	65536
3	<input type="checkbox"/>					

New VC Configuration

VC	Exists	VPI	VCI	Untagged VLAN ID	Tagged VLAN IDs	Transmit PCR
0	<input checked="" type="checkbox"/>	0	35		7,10,40	65536
1	<input type="checkbox"/>					
2	<input checked="" type="checkbox"/>	1	45		21	65536
3	<input type="checkbox"/>					

Valid Attribute Values:
 Untagged VLAN ID: 1..4094
 Tagged VLAN IDs: Empty or comma separated list of numbers from 1..4094
 Transmit PCR (Peak Cell Rate): "MAX" or # cells per second

Modify Reset Entry Fields

Recent Commands... Close Help

Fri Oct 05 16:39:39 EDT 2007 - Polling of 10.52.30.34 successful.
 Java Application Window

FIGURE 7-54 Result of changing VLAN/VC for Internet Service

Note: *If all four VCs are being used and the user wishes to change a VPI/VCI attributes for one of the existing VCs, this cannot be done; the user must delete one of the VCs and then add the new VPI/VCI combination to a new VC.*

7.6 Datafilling the Triple Play Form - Examples

7.6.1 Overview

Note: Before the Triple-Play form is filled out, the following has already been performed:

- The relevant RG profiles have been created
- The relevant iMAP port profiles have been created.
- If voice service is being provided, the initial voice handling configuration (such as G6) is done.

Refer to 5.6.3 for an overview of the Triple Play form and its fields. Once the profiles have been defined, they are included in datafilling the triple play form. The form includes a pull-down where the administrator chooses which RG General profile will be applied to the RG that interfaces the iMAP port. The fields that appear depend on the RG General Profile chosen and the services that are going to be configured on the RG.

The Provision New Triple Play Customer Form is used to provision on one form most of the attributes needed for one Triple Play customer. The fields of the Provision New Triple Play Customer Form are described in 5.6.3.

The form is divided into four main panels: RG, Video/Data Configuration, Video/Data Configuration and Derived Voice.

Using this form is an efficient and error-free method to data fill a customer, and this becomes even more true when used in conjunction with Profiles and the use of Scoping. Following are examples:

1. An iMG624A with the following services and components: (7.6.2)
 - A pc with internet service
 - Two video LAN ports for video service (two STBs)
 - A Transparent LAN Service (TLS that provides a secure and isolated VLAN for customers (802.3).
 - Two levels of phone service
 - POTS24 based phone
 - Derived phone service
2. An RG646 with the following services and components: (7.6.3)
 - Five videos for video service (five STBs)
 - A pc with internet service
 - A phone that is provisioned but not configured, so it can be easily done later.
3. A statically configured RG, usually for demonstration only. (7.6.4)
4. An EPON/ONU interface connected with the iMG646PX-ON. (7.6.5)
5. An RG634 similar to example 1, but with SIP being used for Voice Service. (7.6.6)
6. A multi-service VLAN (more than one service on one VLAN). (7.6.7)
7. An iMG6x6MOD configuration (7.6.8)
8. An AlliedWare Plus Device (7.6.9)
9. Microsoft© Mediaroom™ with the iMG/RG (7.6.10)
10. Video with static IP Address (7.6.11)

Following each figure is the **Provision New Triple Play Customer** Form filled out for each configuration.

7.6.2 Configuration 1 Example - POTS, Derived Voice, Internet, Video, TLS

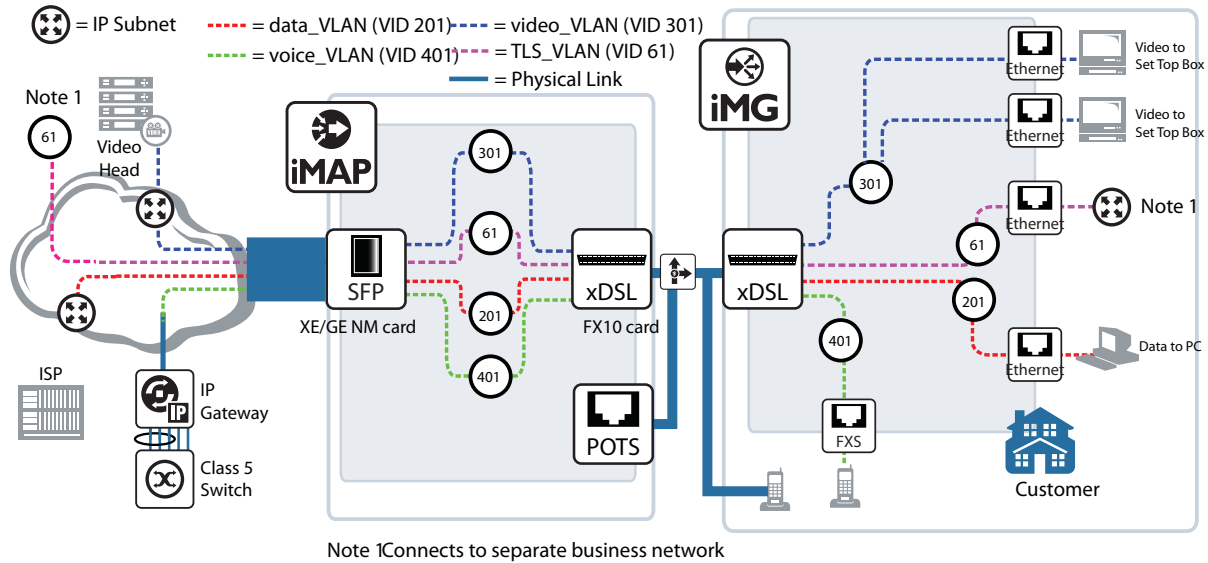

FIGURE 7-55 Example Configuration 1 - Internet Routed/NAT, Video Proxy, Lifeline POTS, TLS

TABLE 7-25 Example Profiles for Configuration 1 - with RG 624

Profile Type	Example Profile Name	Description
Upstream Port Profile	“Auto2+ w/NoFA”	Profile name provides description: Auto2+ = ADSL mode used w/NoFA = with No Filtering and No Ageing
RG General Profile	“DVLKND-AI01-P-1I_2V_1T”	Profile name provides description: DVLKND-AI01- = Access Island 01 P = Phone (Derived Voice) 1I = 1 internet 2V = 2 Video 1T = 1 TLS
RG Internet Profile	“Bridged Int Srv”	
RG Video Profile	“Video-Flood”	A way to highlight the NONE type service, since with no snooping there is flood forwarding. Since there are less than three STBs, this is supported.
RG Voice Profile	“DVLKND-AI01-UpTo4Line”	This is generic for derived voice for Access Island 01; with this profile there is no risk of deprovisioning a derived voice line Using the battery is not reflected in the Profile
Line Profile	g726_mulaw_10	Provides specific attributes for G6 voice channel for POTS and Derived Voice. (These were part of the initial G6 setup.) This field determines the Interface Groups available which in term determines the CRVs available. These values are usually part of a work order

The following figure shows how the Triple Play form is filled out to reflect these profiles, since most of the values are automatically datafilled when the Profiles are included.

Note the use of Scoping for both the RG General and the RG Voice Profiles, as shown in Figure 7-57 and Figure 7-58. The Profile Scoping field is set to the Access Island Prefix (AI01) with the wildcard (*). When the user brings up the Triple Play form and chooses a device, the available General and Voice profiles are based on the scope set. Conversely, if the user chooses a General or Derived Voice Profile with the scope set, only Access Devices that are within that scope are available.

Note: If the user is deploying (or re-deploying) an RG General Profile that includes TLS to an RG that has not been configured for TLS, there will be a prompt for the user to enter the TLS VLAN, which must be previously created.

Provision New Triple Play Customer

Description (Customer ID): 916-555-1212 Add Customer Info

iMG/RG General Configuration

iMG/RG General Profile: DVLKND-AI01-T_11-2 iMG/RG MAC Address:

Video/Data Configuration

Access Device: DVLKND-AI01-HT Slot Port: 10.8 Port Profile: Auto2+ w/NoFA

Data Svcs. Config: Internet Svc. Profile: Bridged Int Srv TLS VLAN: 60

Video Service Config: Video Svc. Profile: Video-Flood

Allowed STB MAC Adrs:

STB #1: STB #2: STB #3:

STB #4: STB #5: STB #6:

Voice Configuration

POTS: Access Device: 172.16.33.18 Slot Port: 8.8 POTS Port Profile:

POTS Call Agent: 172.16.64.27 Line Profile: g726_mulaw_10 Interface Group: gr303_1 CRV: 244

Derived Voice: Derived Voice Svc. Profile: DVLKND-AI01-UpTo4

GenBand Configuration:

Port #1: Line Profile: g726_mulaw_10 Interface Group: gr303_1 CRV: 248

Port #2: Line Profile: Interface Group: CRV:

Port #3: Line Profile: Interface Group: CRV:

Port #4: Line Profile: Interface Group: CRV:

Schedule

Now Hold Schedule: Oct 28, 2005 2 45 PM

Provision Recent Commands... Close Help

FIGURE 7-56 Triple Play Customer Form for RG 634 - Two Voice, Two Video, TLS, and One Internet

Create Profile
 Profile Name: DVLKND-AI01-11_2V_3T Profile Type: RG General

Profile Attributes

Mgmt. Info | Wireless | Port Assignment | IP Routes

Attribute New Value

Profile Scoping: None

IMG/RG Bootstrap VLAN Id (1..4094 or None): 201

IMG/RG Mgmt VCVLAN Id (2..4094): 301

Include Service VLANs in Profile: True

IMG/RG Internet VCVLAN Id (2..4094 or None): 401

IMG/RG Video VCVLAN Id (2..4094 or None): 501

IMG/RG Voice VCVLAN Id (2..4094 or None): 601

IMG/RG CES VCVLAN Id (2..4094 or None):

System Power Management: Disabled

Loop Detection: Enabled

SNTP Server (IP Addr. or None): None

Daylight Saving: Disabled

Time Zone: EST

Limited User Login (login or None): None

New Limited User Password:

New Manager Password:

Super User Login (login or None): None

New Super User Password:

Split Management: Disabled

Subscriber User Login: admin

New Subscriber User Password: admin

Mgmt. Subnets

Name	Subnet Addr.	Mask	Start Addr.	End Addr.

Copy values from profile: NoPortAssign Copy

Create Cancel Help

FIGURE 7-57 RG General Profile for Configuration 1

Create Profile
 Profile Name: DVLKNT-A001_UpTo4Line Profile Type: RG Voice

Profile Attributes

Mgmt. Info | Wireless | Port Assignment | IP Routes

Attribute New Value

Profile Scoping: DVLKNT-AI01*

Voip Type: MGCP GBG6

Include Voice VLAN in Profile: False

IMG/RG Voice VLAN Id (2..4094):

Use DHCP to obtain WAN IP Address: False

IMG/RG Domain (Name or None): rg.corp.int

MGC or SIP Proxy Server: 10.2.1.9

SIP Location Server (or None):

Advanced VOIP Params...

Lines

Line	Enabled	EC
Line 1	<input checked="" type="checkbox"/>	8
Line 2	<input checked="" type="checkbox"/>	8
Line 3	<input checked="" type="checkbox"/>	8
Line 4	<input checked="" type="checkbox"/>	8

All Lines Configured Identical Advanced Line Params...

Copy values from profile: MGCP Copy

Create Cancel Help

FIGURE 7-58 RG Voice Profile for Configuration 1

7.6.3 Configuration 2 - Multiple Video, Data, Derived Voice

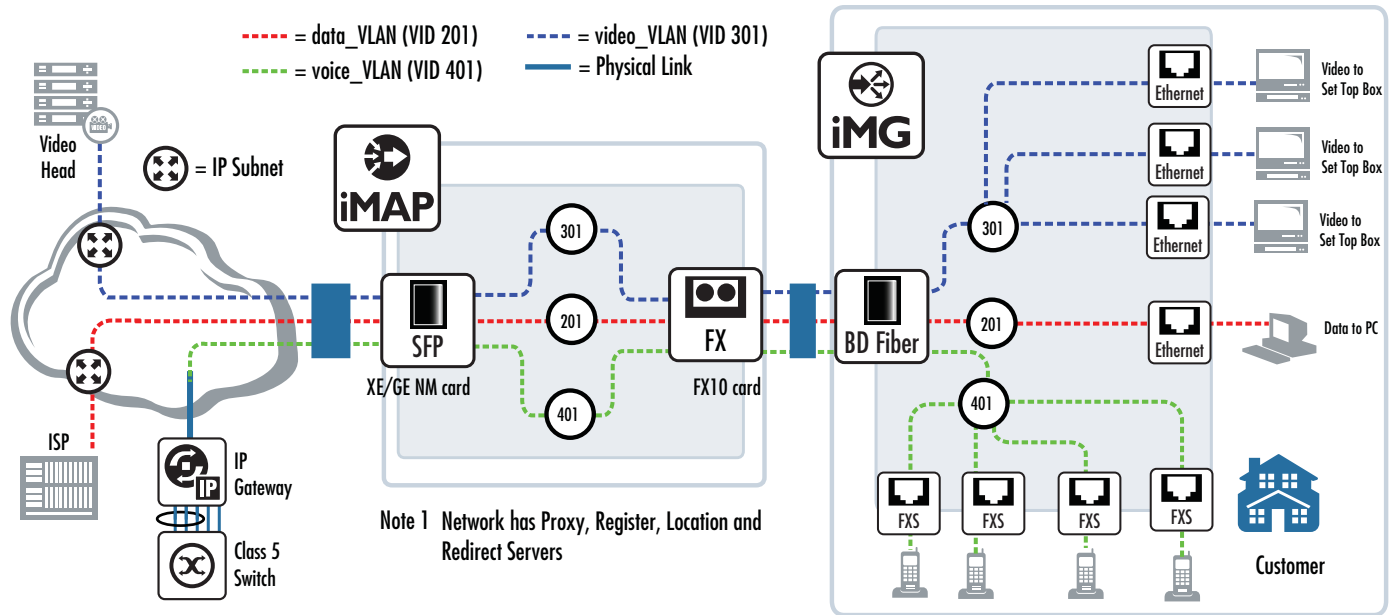

FIGURE 7-59 Configuration 2 - Three Video and One Internet Connection

In this configuration, there are three video devices and one PC with a bridged service. The iMAP customer interface supports up to eight DHCP Auto-filters. With the three STBs and one PC, this is easily supported, although for any changes the administrator should consider the following:

- There should be no “nesting” of STBs behind a local switch.
- If more than one port is used for internet service, using internet NAT service should be considered since the iMAP would only see one DHCP object.

Finally, if more than one port is used for internet service, each port should have a rate limiting rate set in the Profile to prevent possible blocking/pixel loss for the video service ports.

TABLE 7-26 Example Profiles for Configuration 2

Profile Type	Example Profile Name	Description
Upstream Port Profile	“100Mbps”	Stands for Ethernet to the Customer Premises with no Filtering and No Ageing, on an Ethernet 100Mbps.
RG General Profile	“DVLKND-AI01-Plus”	Stands for Access Island AI01
RG Internet Profile	“InternetBridged”	Stands for Routed NAT service with the firewall enabled
RG Video Profile	“Video-3_STBs_SNOOP”	With three STBs, snooping will help with controlling bandwidth to each STB
RG Voice Profile	“Voice-4_Phones”	Generic, to always allow up to four derived voice

The following figure shows how the Triple Play form is filled out to reflect these profiles, since most of the values are automatically datafilled when the Profiles are included.

Note the use of Scoping for both the RG General and the RG Voice Profiles, as shown in Figure 7-61. The Profile Scoping field is set to the Access Island Prefix (AI01) with the wildcard (*). When the user brings up the Triple Play form and chooses a device, the available General and Voice profiles are based on the scope set.

Provision New Triple Play Customer

Description (Customer ID): Triple_Play_Test_6 Hide Customer Info

Customer Info
 Mr. Test Customer
 123 East Sunshine Dr.
 708-555-1221

iMG/RG General Configuration
 iMG/RG General Profile: DVLK-AI01-Plus iMG/RG MAC Address:

Video/Data Configuration
 Access Device: dvlknd-ai01-ht1x71.map Slot Port: 5.6 (FX) Port Profile: DVLK-AI01-100Mbps (Etherlike Port)
 Data Svcs. Config: Internet Svc. Profile: InternetBridged
 Video Service Config: Video Svc. Profile: Video-3_STBs
 Allowed STB MAC Adrs:
 STB #1: 00:02:02 STB #2: 00:0D:DA STB #3:
 STB #4: STB #5: STB #6:

Voice Configuration
 Derived Voice: Derived Voice Svc. Profile: Voice-4_Phones
 GenBand Configuration:
 Port #1: Line Profile: toll-grade-voice Interface Group: FTP1-0-0-0 (gr303) CRV: 10
 Port #2: Line Profile: Interface Group: CRV:

Schedule
 Now Hold Schedule: Jan 23, 2006 8 36 AM

Provision Recent Commands... Close Help

FIGURE 7-60 Triple Play Customer Form for RG 646 - Configuration 2

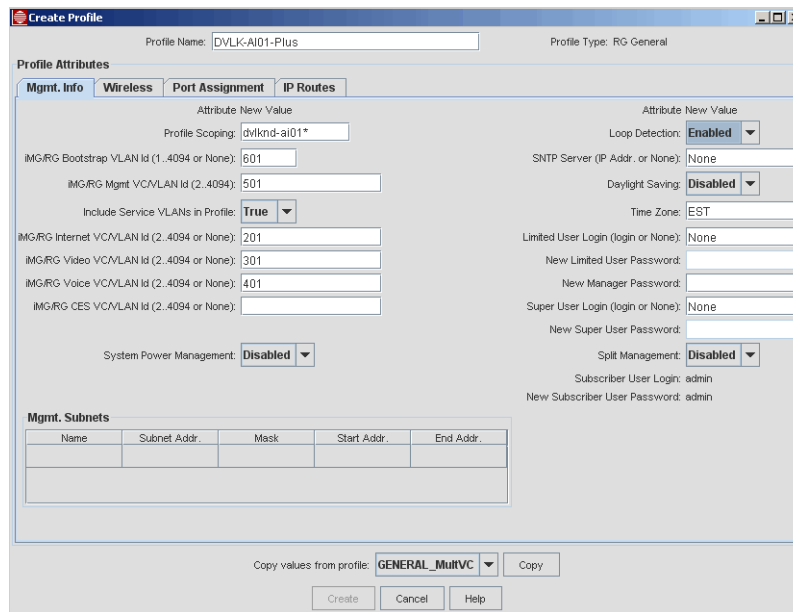

FIGURE 7-61 RG General Profile for Configuration 2 - Mgmt. Info

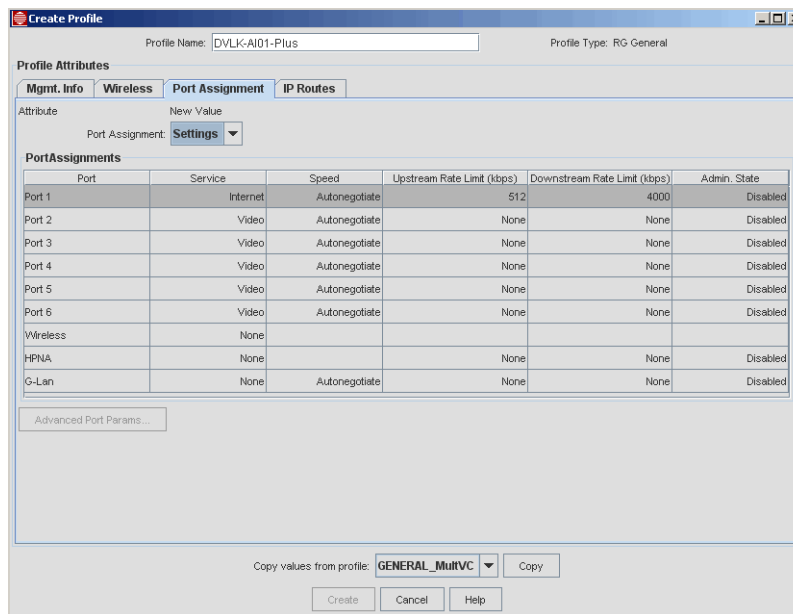

FIGURE 7-62 RG General Profile for Configuration 2 - Port Assignment

Once the RG is pre-provisioned, it appears in the Network Inventory View under iMG/RGs. Right clicking on the device and selecting View/Modify Details brings up the tabbed form that includes all of the device attributes. Subsection 7.7 goes through these tabs and highlights important attributes.

Note: Refer to 5.6.12 for an overview of the Triple Play Service Management Form and how it can be used to change the configuration.

7.6.4 Configuration 3 - Static Provisioning (no DHCP)

For a quick demonstration, an RG can be configured (providing all services and management addresses) using static provisioning; once some profiles are set up, hard-coded values are filled in for the forms.

7.6.4.1 Prerequisites (Profiles and Hard-coded Values)

Before setting up a static model, the user should create some profiles that in critical ways do **not** have certain values filled in. This will control the Triple Play form when these Profiles are chosen.

The following figures show two profiles:

- HomeNetworkInet-StaticIP - Note that the Use DHCP to Obtain IP Address is set to False.
- VOIPPhone - StaticIP - Note that the Use DHCP to Obtain IP Address is set to False and the iMG/RG Domain is set to None.

Create Profile

Profile Name: Profile Type: RG Internet

Profile Attributes

General Internet Info | Security | Firewall | NAT

Attribute New Value

Internet Service Type: **Routed Service** ▼

Include Internet VLAN in Profile: **True** ▼

iMG/RG Internet VC/VLAN Id (2..4094):

Use PPPoE: **False** ▼

iMG/RG Local Customer VLAN Id (2..4094):

Use DHCP to obtain WAN IP Address: **False** ▼

DNS Servers (list of IP Adrs. or None):

Local IP Address:

Local Mask:

Local DHCP Start IP Address:

Local DHCP End IP Address:

Rate Limiting: **Disabled** ▼

Up. Rate Limit (1..50000 kbps):

Up. Burst Size (1..67108 bps):

Up. Scalar (1..100):

Down. Rate Limit (1..50000 kbps):

Down. Burst Size (1..67108 bps):

Down. Scalar (1..100):

Copy values from profile: ▼

FIGURE 7-63 Internet Profile - no DHCP

Create Profile

Profile Name: VOIPPhone-StaticIP Profile Type: RG Voice

Profile Attributes

Attribute New Value

Profile Scoping: None

Voip Type: MGCP

Include Voice VLAN in Profile: False

iMG/RG Voice VC/VLAN Id (2.4094):

Use DHCP to obtain WAN IP Address: False

iMG/RG Domain (Name or None): None

MGC or SIP Proxy Server: 10.2.1.9

SIP Location Server (or None):

Advanced VOIP Params...

Lines

Line	Enabled	EC	Caller ID
Line 1	<input checked="" type="checkbox"/>	8	None
Line 2	<input checked="" type="checkbox"/>	8	None
Line 3	<input checked="" type="checkbox"/>	8	None
Line 4	<input checked="" type="checkbox"/>	8	None

All Lines Configured Identically

Advanced Line Params...

Copy values from profile: Copy

Create Cancel Help

FIGURE 7-64 RG Voice Profile - Static Configuration

Moreover, some hard-coded values must be known before beginning the procedure, since these static Profiles will make certain fields appear that must be filled in on the Triple Play form:

- RGMgmt IP Address - This does not need to be known if the user sets up discovery so that the IP address is included in the Discovery process. In most cases, however, the user must have a unique IP address and will associate this with the RGMgmt VLAN. This is highlighted in the next subsection.
- Internet service IP Address
- Voice Service IP Address
- Masks for the IP Addresses
- MAC address for the iMG/RG

7.6.4.2 Setting Up the IP Address for the iMG/RG

To give the iMG/RG a manual IP address, and to associate this address with the RGMgmt VLAN, the user should perform the following, noting that the procedure is different for Ethernet vs. ADSL types.

1. Choose the method of giving the iMG/RG the unique IP address depending on the type.
 - For Ethernet:
 1. Connect an iMG/RG ethernet console port to the console port of a PC.

Note: The console cable is sold separately by ATI. Use n-8-1-38400 for the console port setting.

2. Log in to the iMG/RG and set up the unique IP address
- For ADSL
 1. Connect the PC ethernet port to a LAN port on an iMG/RG.
 2. Power cycle the ADSL modem.
 3. While the modem is powering up/reconnecting, hold the reset button of the RG for ~30 seconds.
 4. The ADSL modem now has the following:
 - IP Interface of ip0

- VLAN=1 untagged
 - IP address = 192.168.1.1
 - DHCP=Off
5. telnet into the ADSL modem using the 192.168.1.1 address.
 6. Change the IP address to the unique IP address.
 7. Save the configuration and set this as the default - You can now take the RG to the customer site if not already there.

7.6.4.3 Filling out the Triple-Play Form

Using the Profiles described above and the hard-coded values, the user can fill out the Triple-Play form, as shown in the following figure. Key fields are in the table below.

TABLE 7-27 Triple-Play Form Values for Example Static Configuration

Field	Value	Notes
Description	Static Customer	Since this is usually a for demonstration, should describe type of configuration
iMG/RG MAC Address	00:0D:DA:00:02:D9	
Access Device Name Slot.Port	192.168.42.39 10.2	Not required if the iMG/RG is not connected to the iMAP.
Internet Svc. Profile	HomeNetworkInet-StaticIP	Refer to 7.6.4.1. When this profile is entered, values that are normally created by DHCP are now editable.
Internet IP Addr Mask	10.10.2.39 255.255.255.192	Internet Subnet
Local IP Addr. Mask	192.168.0.1 255.255.255.252	IP address for the RG
DHCP Start Addr. DHCP End Addr.	192.168.0.2 192.168.0.2	for customer side addresses when RG acts as DHCP server
Derived Voice Svc. Profile	VOIPPhone-StaticIP	Refer to 7.6.4.1.
IP Addr Mask	10.10.144.123 255.255.255.0	Voice Subnet
GenBand Configuration	Line Profile: g711 Interface Group: gr303 (gr303) CRV: 1	format is: name (type)

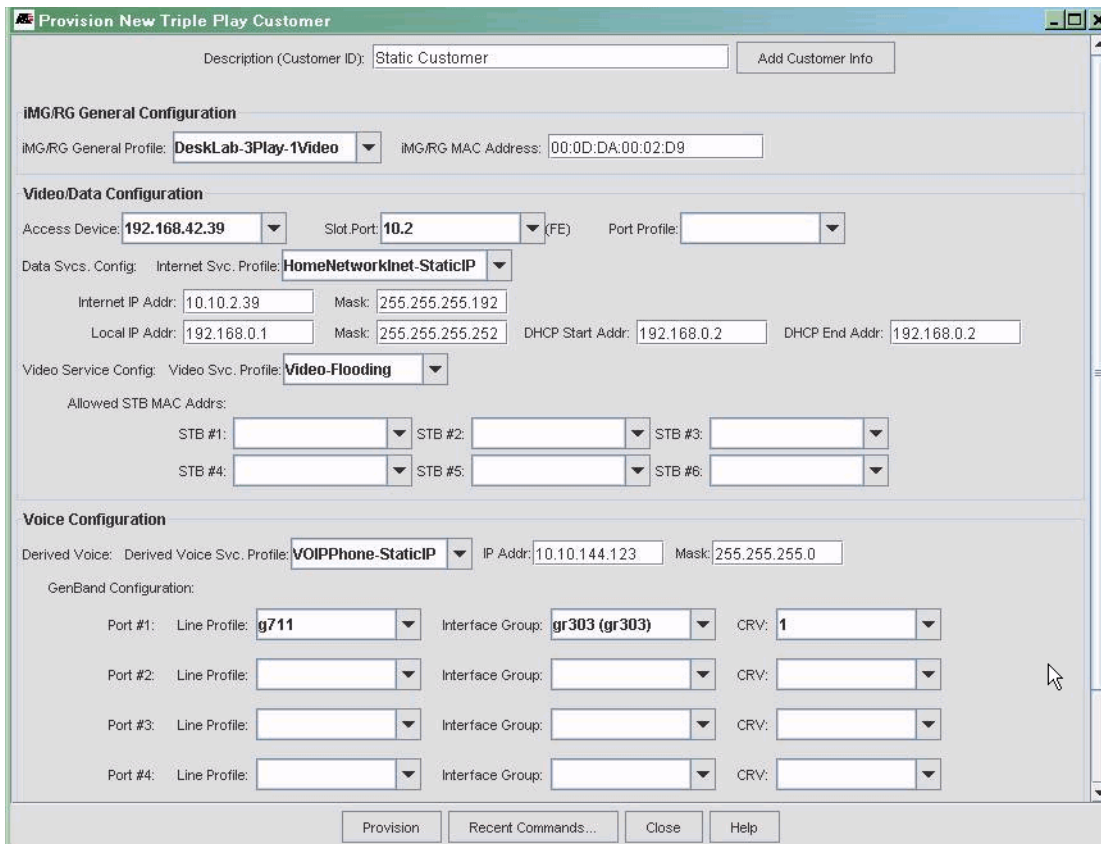

FIGURE 7-65 Triple Play Form for Static Provisioning

After clicking on Provision, the AlliedView NMS stores all of the values.

If the RG has previously been discovered, the values in the Triple-Play form are applied. If the RG has not been discovered, discovery can be done in two ways:

- Wait for the 24-hour discovery cycle to discover the RG. The AlliedView NMS will perform an SNMP ping and eventually ping using the address given to the RG (assuming the AlliedView NMS has discovery set up for the subnet that the manually given IP address belongs to).

Note: The default Discovery period is 24 hours, assuming there are few enough devices so that in 24 hours all devices can be discovered. If there are a large number of devices, the period will extend beyond 24 hours.

- Manually add the RG using Add Node, as explained next.

7.6.4.4 Add the RG to the Network

Selecting *Edit -> Add Node* brings up the Add Node window, as shown in the following figure.

FIGURE 7-66 Adding the RG to the Network Manually (Add Node Form)

When the user clicks on **Add Node**, the AlliedView NMS immediately begins configuring the RG. In the iMG/RG table (under Network Inventory), the RG with the ID “Static Customer” at first has no columns filled in since it has not been discovered. Once discovered, the columns begin to fill in. The IP address value from the Add Node form appears, and finally the Profiles appear. Refer to the following figure.

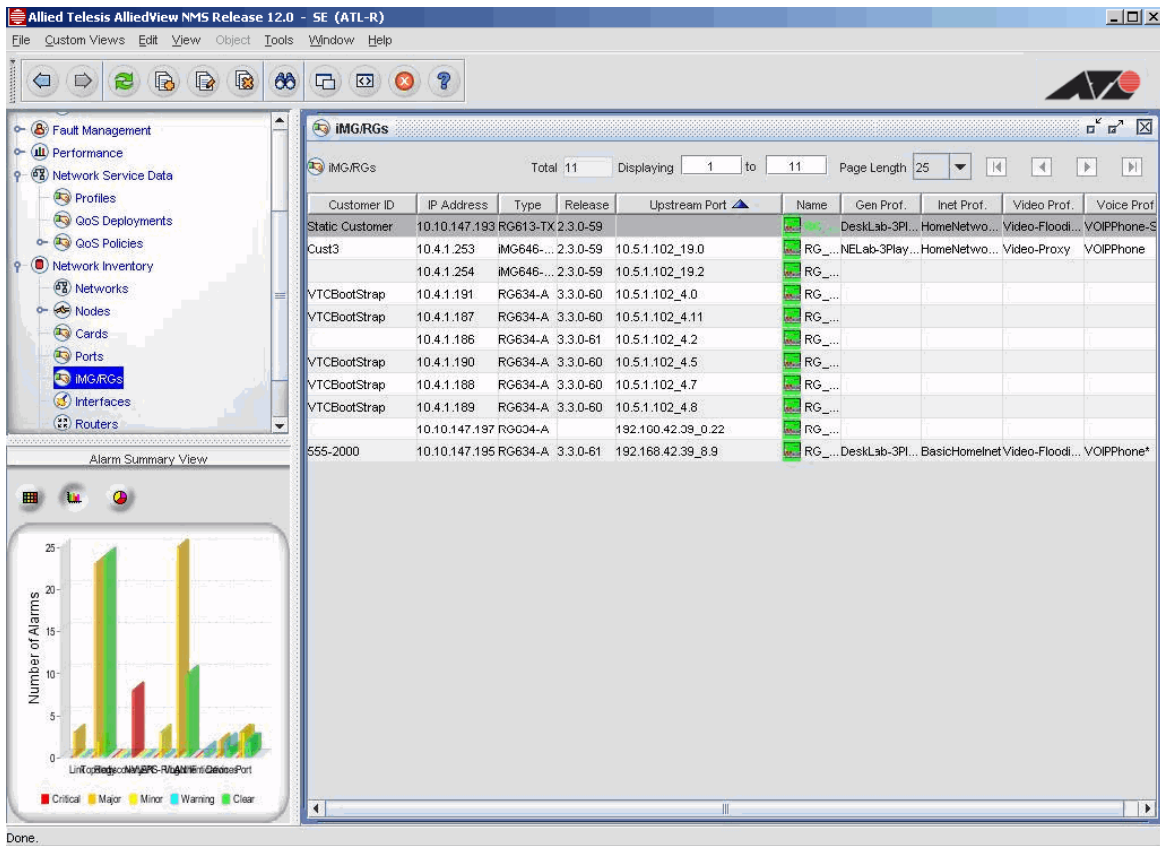

FIGURE 7-67 Adding RG with Static Values - Discovery Complete

Note that the Upstream Port field is not filled in, since DHCP discovery was not used.

7.6.4.5 Viewing Static Configuration

Viewing the status windows shows the differences between the statically and dynamically configured iMG/RG. The following figures list the tabbed windows that show these differences.

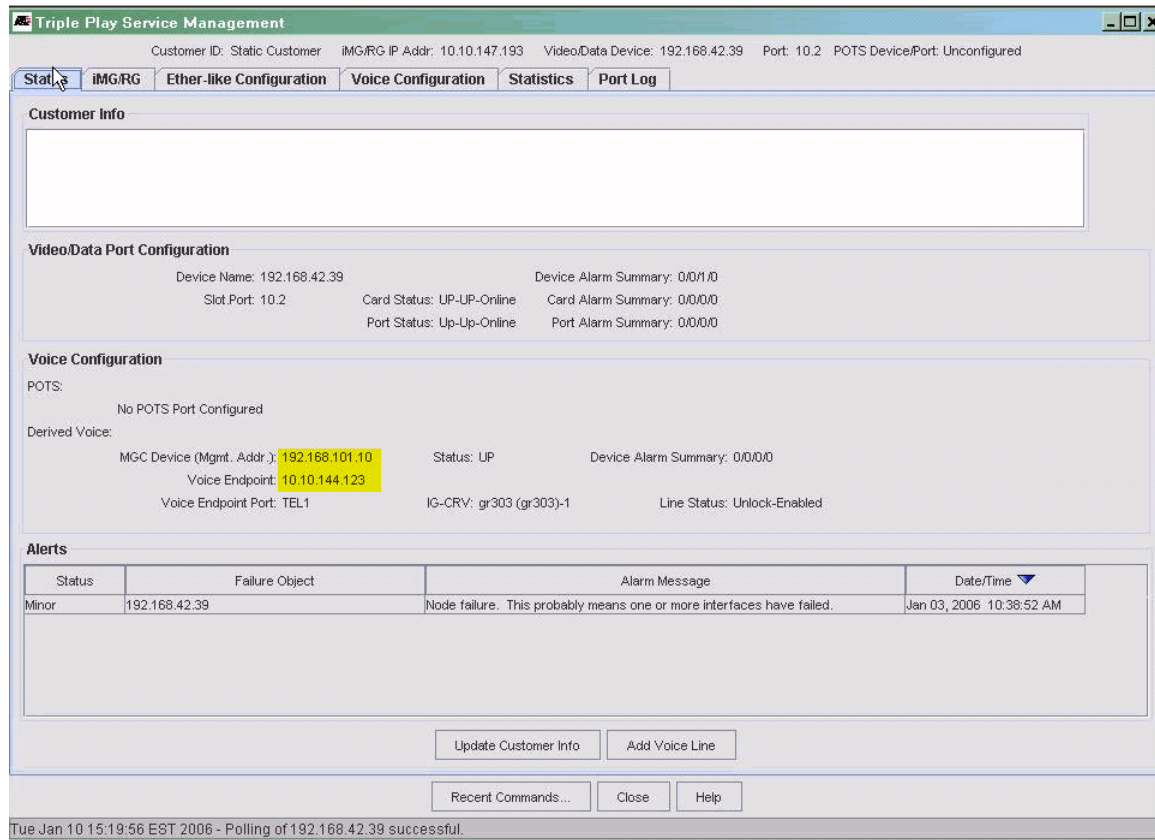

FIGURE 7-68 Static iMG/RG Configuration - Status Tab

Customer ID: Static iMG/RG IP Addr: 10.52.31.121 Video/Data Device: 10.52.30.35 Port: 5.5 POTS Device/Port: Unconfigured

Internet Service | Security | Firewall | NAT | Video Service | Voice Service

Current Value	Current Value	New Value
iMG/RG Mgmt VLAN: 7	Internet Service Profile: None	<input type="text"/>
TLS VLAN: None	Internet Service Type: Routed Service	<input type="text"/>
Video VLAN: 40	iMG/RG Internet VLAN (2..4094 or None): 20	<input type="text"/>
Voice VLAN: 10	Use PPPoE: False	<input type="text"/>
PPPoE Connection State: N/A	PPPoE User Name:	<input type="text"/>
	PPPoE Password:	<input type="text"/>
	TCP MSS Clamp: Disabled	<input type="text"/>
	Internet MTU (600..1500): 1500	<input type="text"/>
	iMG/RG Local Customer VLAN ID (2..4094): 2	<input type="text"/>
	Use DHCP to obtain WAN IP Address: False	<input type="text"/>
	DNS Servers (list of IP Addr. or None): None	<input type="text"/>
	Internet IP Address: 10.52.31.213	<input type="text"/>
	Internet Mask: 255.255.255.224	<input type="text"/>
	Local IP Address: 192.168.1.6	<input type="text"/>
	Local Mask: 255.255.255.0	<input type="text"/>
	Local DHCP Start IP Address: 192.168.1.10	<input type="text"/>
	Local DHCP End IP Address: 192.168.1.10	<input type="text"/>

Editable Fields ⇔

Buttons: Modify, Clear Entry Fields, Save iMG/RG Configuration, Recent Commands..., Close, Help

Tue Jul 19 14:04:15 EDT 2011 - Polling of RG_1305141810187 successful.

FIGURE 7-69 Static iMG/RG Configuration - Internet Service Tab

The screenshot shows the 'Triple Play Service Management' window with the 'Voice Service' tab selected. The interface is divided into several sections:

- Customer Information:** Customer ID: Static Customer, iMG/RG IP Addr: 10.10.147.193, Video/Data Device: 192.168.42.39, Port: 10.2, POTS Device/Port: Unconfigured.
- Navigation Tabs:** Status, iMG/RG, Ether-like Configuration, Voice Configuration, Statistics, Port Log.
- Sub-Tabs:** Mgmt. Info, Port Assignments, IP Routes, Internet Service, Video Service, Voice Service.
- Configuration Fields:**
 - Current Value: Internet Svc. VLAN: 1003, Voice VLAN: 803, Service Path: Private Path, Use DHCP to obtain WAN IP Address: False, VOIP IP Address: 10.10.144.123, VOIP Mask: 255.255.255.0, iMG/RG Domain (Name or None): None.
 - New Value: Voice Service Profile: VOIPPhone-StaticIP, VOIP Provider Interface: MGCP GBG6, MGC or SIP Proxy Server (IP Addr[:Port]): 10.2.1.9, SIP Location Server (IP Addr[:Port] or None): None.
- Line Configuration Tables:**
 - Current Line Configuration:**

Line	Enabled	CNG	VAD	EC
Line 1	<input checked="" type="checkbox"/>	<input type="checkbox"/>	<input type="checkbox"/>	8
Line 2	<input checked="" type="checkbox"/>	<input type="checkbox"/>	<input type="checkbox"/>	8
 - New Line Configuration:**

Line	Enabled	CNG	VAD	EC
Line 1	<input checked="" type="checkbox"/>	<input type="checkbox"/>	<input type="checkbox"/>	8
Line 2	<input checked="" type="checkbox"/>	<input type="checkbox"/>	<input type="checkbox"/>	8
- Buttons:** Modify, Clear Entry Fields, Reset Changes, Save iMG/RG Configuration, Recent Commands..., Close, Help.

FIGURE 7-70 Static iMG/RG Configuration - Voice Service Tab

7.6.5 Configuration 4 - EPON/ONU Interface Connected with iMG646PX-ON

This example is similar to the first two examples, but the use of Profiles is highlighted because of the use of EPON/ONU specific QoS policies, as explained in 6.11.11.

Provision New Triple Play Customer

Description (Customer ID):

iMG/RG General Configuration

iMG/RG General Profile: iMG/RG MAC Address:

Video/Data Configuration

Access Device: Slot.Port: (ONU) ONU MAC Addr.: Port Profile: (ONU)

Data Svcs. Config: Internet Svc. Profile:

Video Service Config: Video Svc. Profile:

Allowed STB MAC Adrs:

STB #1: STB #2: STB #3:

STB #4: STB #5: STB #6:

Voice Configuration

Derived Voice: Derived Voice Svc. Profile:

GenBand Configuration:

Port #1:	Line Profile: <input type="text" value="g711"/>	Interface Group: <input type="text" value="gr303 (gr303)"/>	CRV: <input type="text" value="7"/>
Port #2:	Line Profile: <input type="text"/>	Interface Group: <input type="text"/>	CRV: <input type="text"/>
Port #3:	Line Profile: <input type="text"/>	Interface Group: <input type="text"/>	CRV: <input type="text"/>
Port #4:	Line Profile: <input type="text"/>	Interface Group: <input type="text"/>	CRV: <input type="text"/>

Schedule

FIGURE 7-71 Triple-Play for the EPON/ONU

Figure 7-71 shows the Triple-Play form when filled out for the ONU interface. The main differences are the ONU interface format (the EPON slot.port and ONU logical ID) and the MAC address for the ONU.

FIGURE 7-72 Service Management Window -> iMG/RG Tab for EPON/ONU

Figure 7-72 shows the Service Management Form once the iMG/RG is configured. The iMG/RG-> Mgmt. Info tab provides a summary of all the main attributes.

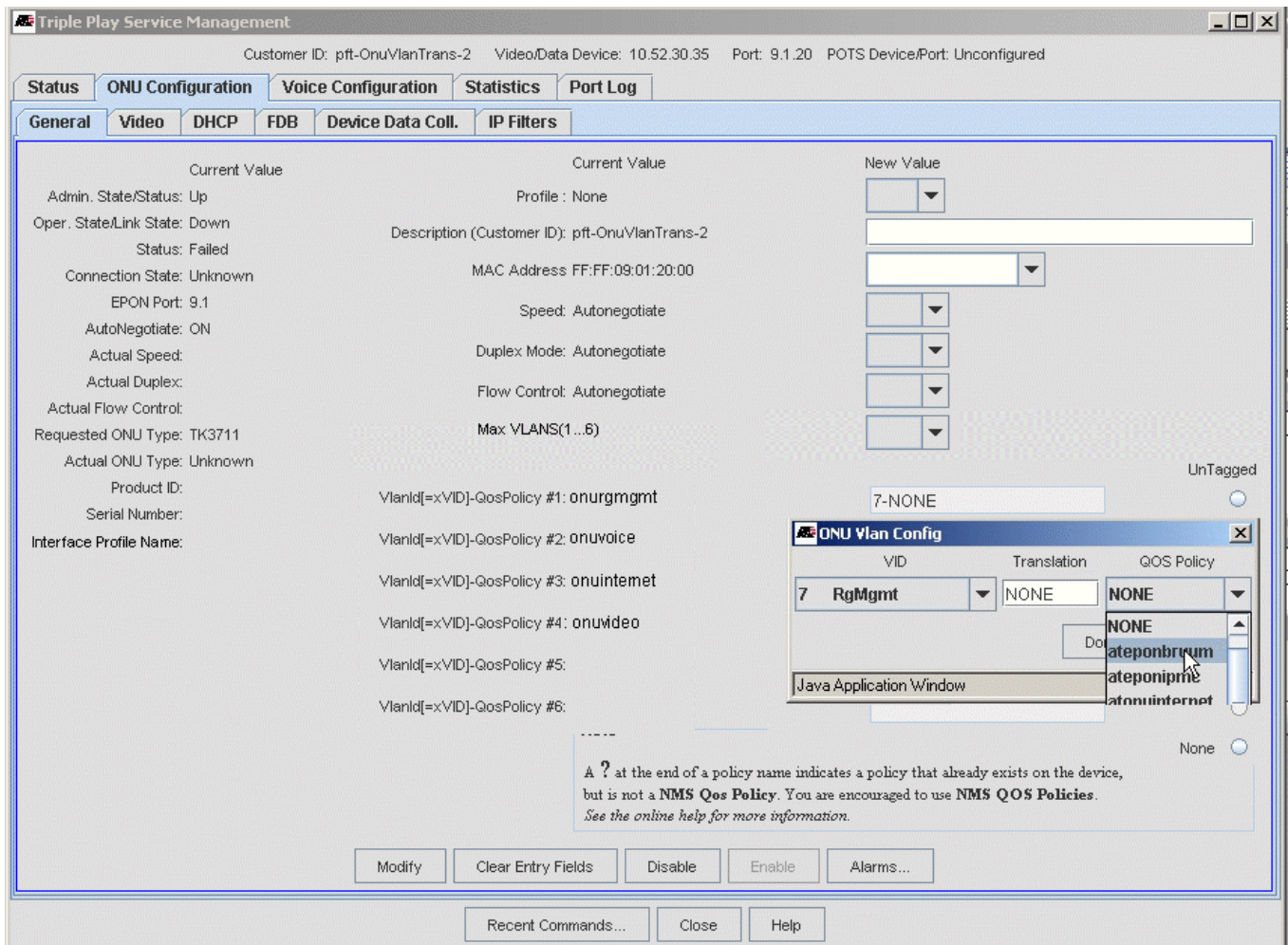

FIGURE 7-73 Service Management Window -> ONU Configuration Tab for EPON/ONU

Figure 7-73 shows the Service Management Form with the ONU Configuration tab. On this form the user can change the VLAN-QoS policy association. The available VLANs and policies are included in the pull-down menus.

Note: The EPON supports translations. When the user clicks on the New Value field for the VLAN Info, a pop-up includes the VID, translation, and QOS Policy that are to be associated. These are the same values that can be datafilled with the ONU profile. As with other profiles, the user should be aware that if the ONU was configured with a profile and changes are made here, the ONU will be out of sync with the Profile.

7.6.6 Configuration 5 - Voice Service Provided by SIP

Configuration 5 is similar to Configuration 1, but in this example the voice service is provided by SIP. Refer to the following figure.

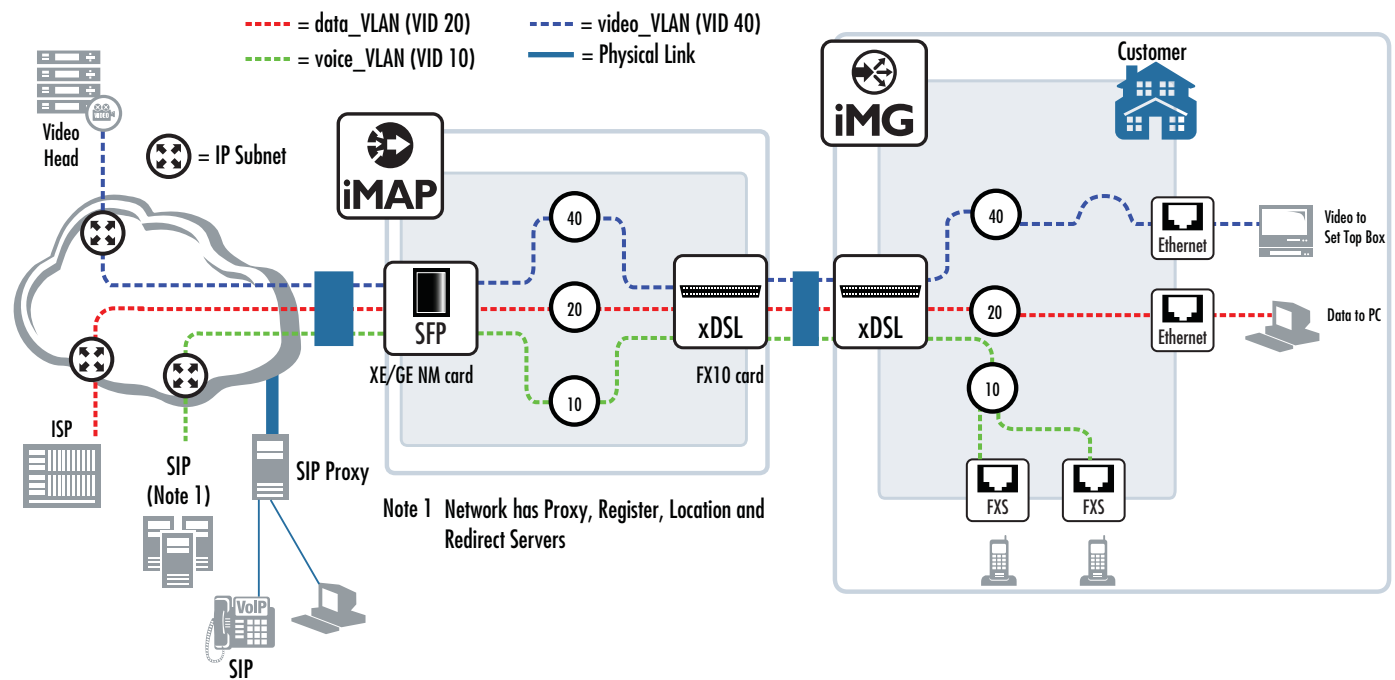

FIGURE 7-74 Configuration 5 - VoIP using SIP

Note: This example is included because a phone is included that connects to the SIP network using the POTS24 that has been configured to support SIP.

Refer to the following figure to show how the Triple Play form is filled out to support SIP.

The screenshot shows a web-based configuration interface titled "Provision New Triple Play Customer". The form is organized into several sections:

- Description:** Customer ID is "Data_Video_SIP".
- iMG/RG General Configuration:** Profile is "Triple Play".
- Video/Data Configuration:** Access Device is "10.52.30.33", Slot.Port is "0.2" (ADSL). It includes fields for Allowed IP Addr. Ranges (Range #1-6) and Allowed STB MAC Adrs (STB #1-6).
- Voice Configuration:** POTS Access Device is "10.52.30.34", Slot.Port is "6.1", and POTS Port Profile is "POTS1". It includes fields for POTS Call Agent, Line Profile, Interface Group, CRV, and Derived Voice (SIP_Example). SIP Configuration includes Port #1, Number (9197472100), Login (login), and Password (password).
- Schedule:** Radio buttons for "Now", "Hold", and "Schedule". The "Schedule" option is selected with date "Dec 12, 2006", time "12:44 PM".

Buttons at the bottom include "Provision", "Recent Commands...", "Close", and "Help".

FIGURE 7-75 Triple Play Form with SIP for Voice

7.6.7 Configuration 6 - Multi-Service VLAN

Configuration 6 involves placing more than one service on a VLAN.

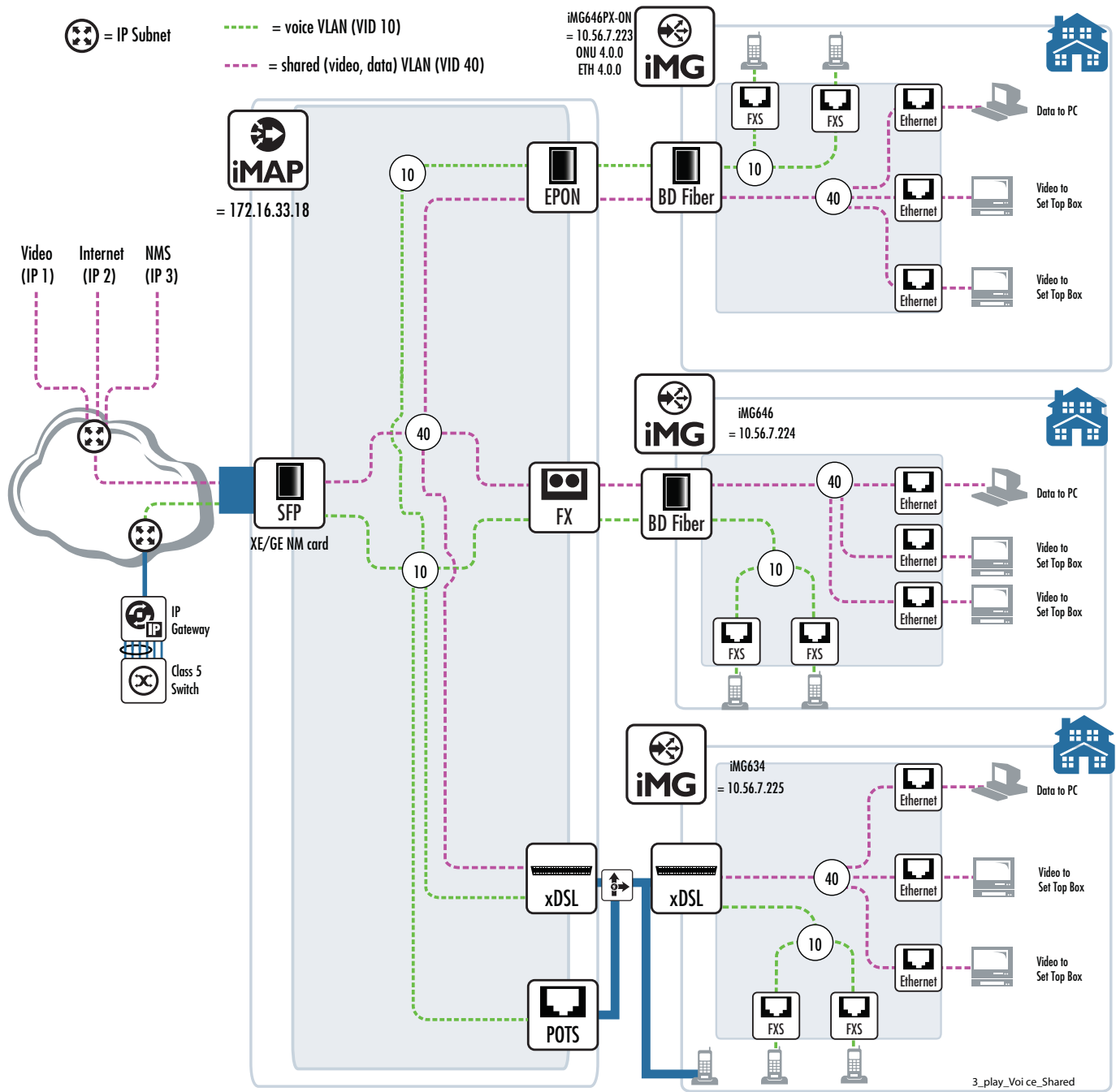

FIGURE 7-76 Configuration 6 - Multi-Service VLAN

7.6.7.1 RG Forms

Create Profile

Profile Name: Profile Type: RG General

Profile Attributes

Mgmt. Info | Wireless | Port Assignment | IP Routes

Attribute New Value

Profile Scoping:

IMG/RG Bootstrap VLAN ID (1..4094 or None): Persist

IMG/RG Mgmt VC/VLAN ID (2..4094):

Include Service VLANs in Profile: ▼

IMG/RG Internet VC/VLAN ID (2..4094 or None):

IMG/RG Video VC/VLAN ID (2..4094 or None):

IMG/RG Voice VC/VLAN ID (2..4094 or None):

IMG/RG CES VC/VLAN ID (2..4094 or None):

IMG/RG Additional VLAN IDs:

System Power Management: ▼

Attribute New Value

Loop Detection: ▼

SNTP Server (IP Addr. or None):

Daylight Saving: ▼

Time Zone:

Limited User Login (login or None):

New Limited User Password:

New Manager Password:

Super User Login (login or None):

New Super User Password:

Split Management: ▼

Subscriber User Login: admin

New Subscriber User Password: admin

Mgmt. Subnets

Name	Subnet Addr.	Mask	Start Addr.	End Addr.

Copy values from profile: ▼

FIGURE 7-77 Shared VLAN - RG General - Mgmt. Info

Create Profile
Profile Name:
Profile Type: RG Internet

Profile Attributes

General Internet Info

Security

Firewall

NAT

Attribute New Value

Internet Service Type: Routed Service ▼

Include Internet VLAN in Profile: True ▼

iMG/RG Internet VC/VLAN Id (2..4094):

Use PPPoE: False ▼

iMG/RG Local Customer VLAN Id (2..4094):

Use DHCP to obtain WAN IP Address: True ▼

DNS Servers (list of IP Addr. or None):

Local IP Address:

Local Mask:

Local DHCP Start IP Address:

Local DHCP End IP Address:

Rate Limiting: Disabled ▼

Up. Rate Limit (1..50000 kbps):

Up. Burst Size (1..67108 bps):

Up. Scalar (1..100):

Down. Rate Limit (1..50000 kbps):

Down. Burst Size (1..67108 bps):

Down. Scalar (1..100):

Copy values from profile: ▼

Copy

Create

Cancel

Help

FIGURE 7-78 Multi-service VLAN - Internet - General Profile

Create Profile

Profile Name: Multi_serv_VLAN Profile Type: RG Video

Profile Attributes

General Video Info

Attribute	New Value
Include Video VLAN in Profile:	True
iMG/RG Video VC/VLAN ID (2..4094):	40
Use DHCP to obtain WAN IP Address:	
IGMP Mode:	Snooping
Multicast Acceleration:	Disabled
IGMP Timeout (1..65535 seconds):	250
IGMP Leave Time:	
IGMP Security:	Enabled
IGMP Security Autolearning:	Enabled
Trusted Host Limit (1..6):	2
IGMP Default Fast Leave:	Enabled

Copy values from profile: VIDEO_MultVC Copy

Create Cancel Help

FIGURE 7-79 Multi-service VLAN - Video Profile

Create Profile Profile Name: Profile Type: RG Voice

Profile Attributes

Attribute New Value

Profile Scoping:

Voip Type:

Include Voice VLAN in Profile:

IMG/RG Voice VC/VLAN Id (2..4094):

Use DHCP to obtain WAN IP Address:

IMG/RG Domain (Name or None):

MGC or SIP Proxy Server:

SIP Location Server (or None):

Lines

Line	Enabled	EC	Caller ID
Line 1	<input checked="" type="checkbox"/>	8	None
Line 2	<input checked="" type="checkbox"/>	8	None
Line 3	<input type="checkbox"/>		
Line 4	<input type="checkbox"/>		

All Lines Configured Identically

Copy values from profile:

FIGURE 7-80 Multi-service VLAN - Voice Profile

7.6.8 Configuration 7 - iMG7x6MOD with HPNA

The iMG7x6MOD can be configured using the RG forms. Moreover, VLAN translation may be needed to ensure the iMG can be integrated into the network.

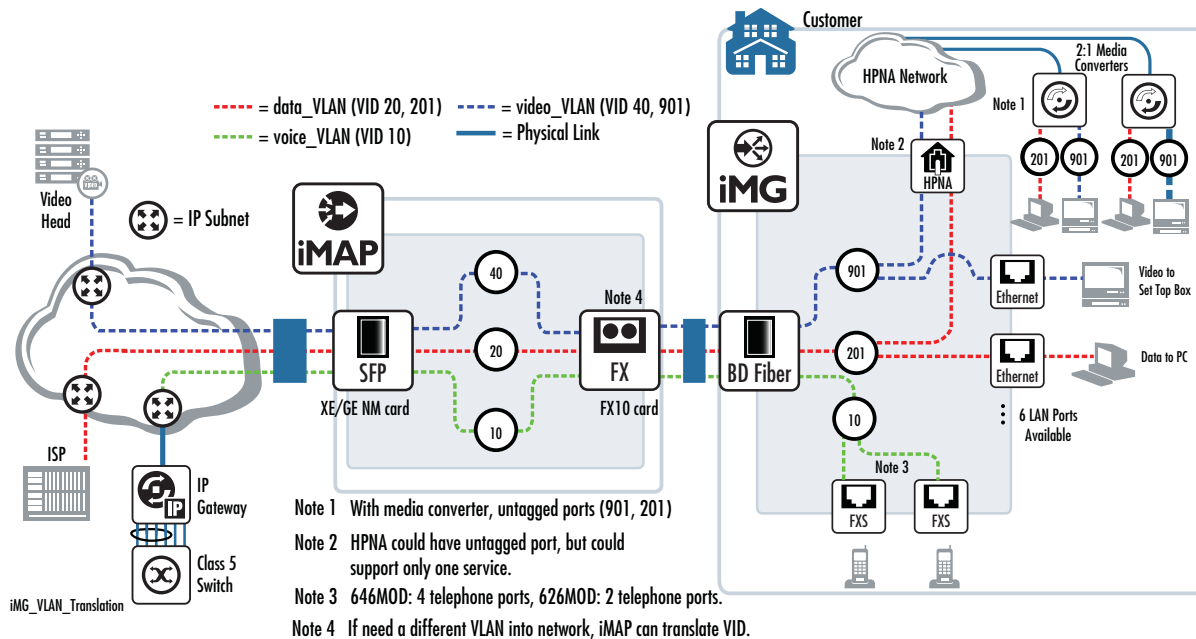

FIGURE 7-81 Configuration 7 - iMG6x6MOD

7.6.8.1 RG Forms

The iMG6x6MOD product, when using the HPNA LAN interface card, can have devices connected to the residence coax network. Since there is now a set of devices associated with the HPNA as well as the LAN ports, the user must ensure that the VLAN configuration matches the system configuration. Moreover, the media converter used between the coax and ethernet interfaces has untagged VLANs on the ethernet interfaces, numbered 201 and 901. The VLANs used on the LAN ports must also have these two VIDs configured.

Note: The HPNA could also be configured to support an untagged VLAN, but this needs to be configured on the default VLAN (1), and the HPNA could support only one service.

Since the upstream network might not be using VLANs 201 and 901 as their VLANs for data and video, the VLAN must be translated to another VID that matches what the network is using. In release 10.0, this translation feature for iMAP interfaces is available on the Port Profile Form. Refer to Figure 7-82.

FIGURE 7-82 Ethernet Port Profile for VLAN Translation (20=201,40=901,10)

Note that when provisioning the iMG Profiles, the user does **not** include any translation information. For example, the RG General profile could be filled out as in Figure 7-83.

The screenshot shows the 'Create Profile' window for 'iMG646MOD'. The 'Profile Type' is 'RG General'. The 'Mgmt. Info' tab is active, showing various configuration options. The 'Attribute New Value' section includes fields for Profile Scoping (None), IMG/RG Bootstrap VLAN Id (1), IMG/RG Mgmt VCVLAN Id (7), Include Service VLANs in Profile (True), IMG/RG Internet VCVLAN Id (201), IMG/RG Video VCVLAN Id (901), IMG/RG Voice VCVLAN Id (10), IMG/RG CES VCVLAN Id, IMG/RG Additional VLAN IDs (None), and System Power Management (Disabled). The right side of the window includes fields for Loop Detection (Disabled), SNTP Server (IP Addr. or None), Daylight Saving (Disabled), Time Zone (EST), Limited User Login (login or None), New Limited User Password, New Manager Password, Super User Login (login or None), New Super User Password, Split Management (Disabled), Subscriber User Login (admin), and New Subscriber User Password (admin). At the bottom, there is a 'Mgmt. Subnets' table with columns for Name, Subnet Addr., Mask, Start Addr., and End Addr., and a 'Copy values from profile' dropdown set to 'GENERAL_MultVC' with a 'Copy' button. 'Create', 'Cancel', and 'Help' buttons are also present.

FIGURE 7-83 RG General Profile for iMG646MOD (No translations datafilled)

For the HPNA, the Port Assignment tab includes the HPNA port, with the options as shown in Figure 7-84 and Table 7-28.

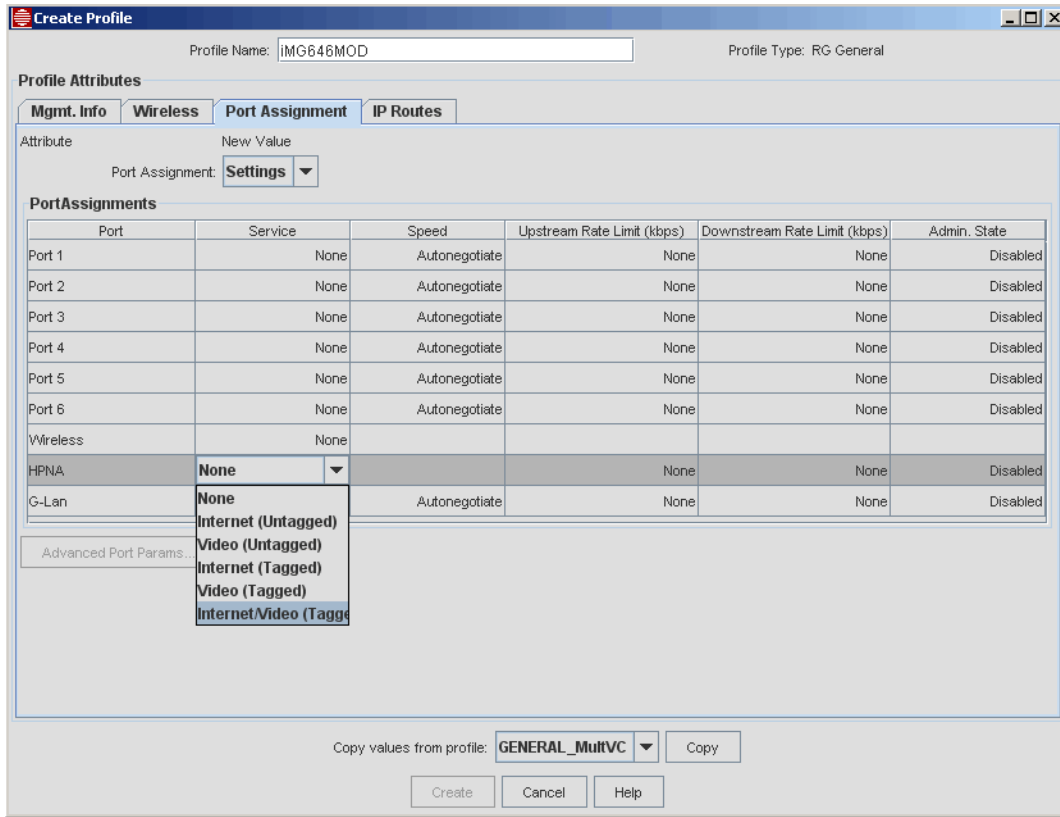

FIGURE 7-84 RG Profile - Port Assignment for HPNA

TABLE 7-28 Provisioning the iMG/RG in Release 10.0

Pull-down Option	Description
Internet (Untagged)	The HPNA can support only internet service
Video (Untagged)	The HPNA can support only video service
Internet (Tagged)	The HPNA supports internet service, but could support video service as well.
Video (Tagged)	The HPNA supports video service, but could support internet service as well.
Internet/Video (Tagged)	The HPNA supports both services.

7.6.9 Configuration 8 - AlliedWare Plus Device

The iMG/RG can be configured with AlliedWare Plus upstream devices (x908, x600, x900) in the same way as iMAP ports (all components provisionable, pre-provisioning so that iMG/RG comes into service automatically).

Following is an example configuration.

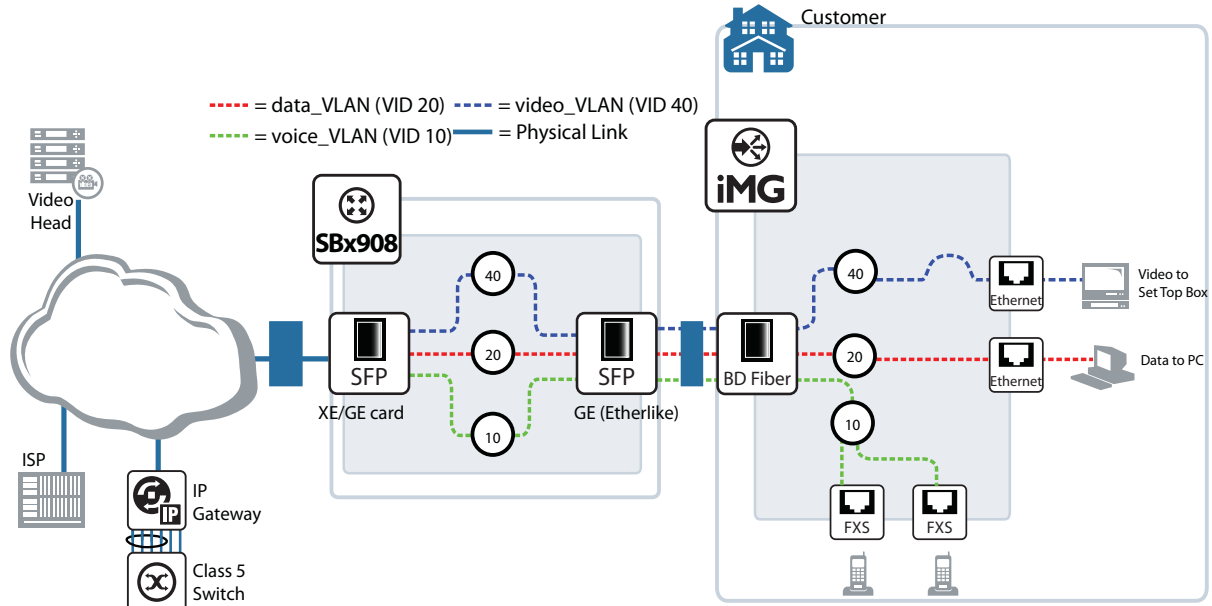

FIGURE 7-85 iMG/RG Connected to x908 Upstream Device.

The Triple-Play form can be used to pre-provision the iMG/RG using the already created Profiles. The Triple-Play form is filled out as with other upstream devices, as shown Figure 7-87.

The few points to note in configuring iMG/RGs to AlliedWare Plus devices are:

- In 12.1, when an AW+ product is first installed, you must use NMS to deprovision the ports before provisioning the ports. This is because they have default descriptions (CustomerID) such as port1.2.4, as shown in the following figure.

Device Name: ai00-dr2.spsi.lab.telesyn.corp

Ports

Port ▼	Type	Customer ID	Status
1.1.1	Ether-like	"to cr2"	Up
1.2.1	Ether-like	"to imap3"	Up
1.2.2	Ether-like	"to dr1"	Up
1.2.3	Ether-like	dr2 port1.2.3	Down
1.2.4	Ether-like	port1.2.4	Down
1.2.5	Ether-like	port1.2.5	Down
1.2.6	Ether-like	port1.2.6	Down
1.2.7	Ether-like	port1.2.7	Down
1.2.8	Ether-like	port1.2.8	Down
1.2.9	Ether-like	port1.2.9	Down
1.2.10	Ether-like	port1.2.10	Down
1.2.11	Ether-like	port1.2.11	Down
1.2.12	Ether-like	port1.2.12	Down
1.3.1	Ether-like	port1.3.1	Down
1.3.2	Ether-like	port1.3.2	Down
1.3.3	Ether-like	port1.3.3	Down
1.3.4	Ether-like	port1.3.4	Down
1.3.5	Ether-like	port1.3.5	Down
1.3.6	Ether-like	port1.3.6	Down
1.3.7	Ether-like	port1.3.7	Down

Provision New Customer/Port... De-provision Customer/Port View/Modify Details... Cut-Over Customer

Recent Commands... Close Help

Fri Jul 02 09:39:39 EDT 2010 - Polling of ai00-dr2.spsi.lab.telesyn.corp successful.

FIGURE 7-86 Provisioning Ports on AlliedWare Plus Devices

Note: After the ports have been provisioned with the NMS, then de-provisioned, their customer ids remain blank. Over time all non-provisioned ports will be blank. It's only when the device is newly installed that they have default descriptions and require this extra de-provisioning step.

- Upstream port numbering - These use the 3-number format (for stack.module.port)
- Each AlliedWare Plus device must function as an L3 Router.
- Customers on each switch must be in non-shared subnets, because these AlliedWare Plus devices do standard DHCP Relay with option 82 as circuit ID only (no remote ID) and do not perform DHCP Snooping.

FIGURE 7-87 Triple Play Form with x908 Upstream Device

Once the form is filled in and the NMS has performed provisioning in software, the iMG will begin its provisioning either immediately (if the iMG/RG is already connected and powered on), or later (when the iMG /RG is connected and powered on). When complete, the iMG is listed and includes its IP address, upstream port, and the associated profiles. Refer to the following figure.

Customer ID	IP Address	Type	Release	Upstream Port	Name	Gen Prof.	Inet Prof.	Video Prof.	Voice Prof.
PX_ON_test	10.52.31.123	IMG646-PX-ON	3.7.4-30	10.52.30.35_9.0.2	RG_1276534272479				
	10.52.31.115	RG600Family		10.52.30.35_8.5	RG_1276534273507				
915onX900	10.52.33.29	iBG915-FX	3.8.0-90	10.52.32.2_1.0.11	RG_1276534274267				
irod	10.52.31.126	IMG626-MOD	3.8.0-90	10.52.30.35_5.9	RG_1276534274542				
IMG634A	10.52.31.120	IMG634-A	3.8.0-90	10.52.30.35_11.3	RG_1276534275581				timSIP*
#613-TX	10.52.31.116	RG613-TX	3.7.3-18	10.52.30.35_11.1	RG_1276534276621				
IMG616W	10.52.31.103	IMG616-W	3.8.0-81	10.52.30.35_5.11	RG_1276534277662				
#06-BD	10.52.31.104	IMG606-BD	3.8.0-81	10.52.30.35_5.7	RG_1276534278703				
	10.52.31.121	IMG646-BD	2.5.0-55	10.52.30.35_5.5	RG_1276534279741				
IMG613RF	10.52.31.113	IMG613-RF	3.8.0-90	10.52.30.35_5.6	RG_1276534280783				
RG656BD	10.52.31.122	RG656-BD	3.8.0-90	10.52.30.35_5.3	RG_1276534281822				timMGC*
IMG613LH	10.52.31.111	RG613-LH	3.8.0-90	10.52.30.35_5.4	RG_1276534282880				
#648MOD	10.52.31.109	IMG646-MOD	3.8.0-90	10.52.30.35_5.1	RG_1276534283962				
MOD5.0	10.52.31.102	IMG646-MOD	3.8.0-90	10.52.30.35_5.0	RG_1276534285003				
IMG634WAR2	10.52.31.118	IMG634-WA-R2	3.8.0-90	10.52.30.37_10.1	RG_1276534276122				
x908_634	10.52.33.126	IMG634-A-R2	3.8.0-90	10.52.32.3_1.4.1	RG_1276623811591	x908General	timINTERNET	timVIDEO	timMGC

FIGURE 7-88 iMG/RG Provisioned - Complete

7.6.10 Configuration 9 - Microsoft® Mediaroom™ with the iMG/RG

The Media Room configuration is sometimes referred to as a “Whole Home” configuration which means configuring the iMG/RG device to allow all media room devices that are connected to the iMG to communicate to each other and share content as needed. In this configuration all media room devices such as PCs, printer, DVR, STB, etc. can share content because they are connected to the same local network. (Additional configuration may be required in STB, PC or other media room devices to setup a fully connected media room environment.)

Sharing a local network also allows connecting any video or data devices to LAN ports configured for media room with the iMG. This is possible because the iMG is configured to assign IP addresses to connected devices using DHCP and allows data sharing through the local network with connections to upstream services as requested by media room devices.

Examples where this type of communication is useful include:

- Sharing a networked printer in the home where there are multiple PCs
- Recording TV broadcast to DVR and viewing on demand content from DVR to PC or STB
- Viewing video, pictures and music library stored in PC to TV
- Future applications may also include networked appliances (e.g. smart refrigerator, etc.)

The iMG/RG can support three configurations:

1. Separate upstream VLANs - This model uses a separate upstream VLAN for each service and also requires a separate management VLAN. This is a model already supported by the NMS.
2. Single upstream VLAN with multiple virtual IP interfaces - This model uses one upstream VLAN and separate virtual interfaces for management, data and voice. A single VLAN simplifies WAN VLAN setup but adds configuration for new virtual interfaces (Virtual interface configuration support is new in iMGs 3-8).
3. Single upstream VLAN with single IP interface - This model uses a single upstream VLAN and also a single IP address for iMG. Network configuration is simplified using one VLAN for all services but is less secure because video, data (Internet) and management traffic are using the same VLAN.

The NMS initially supports Model 1, which is already supported by the NMS. Therefore, the overall steps do not change, but there are additions to the profiles to provision the iMG.

The following figure shows the basic configuration.

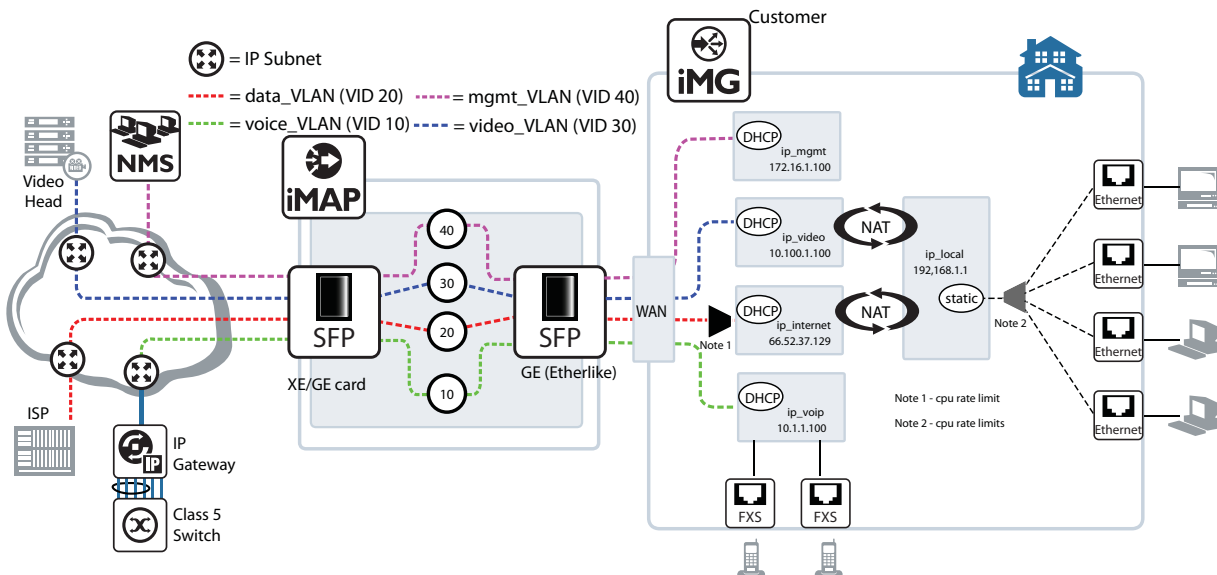

FIGURE 7-89 Media Room Configuration

The figure shows the separate upstream VLANs model to support the media room configuration with the iMG. On the upstream side the VLANs follow the existing model, but on the iMG all LAN ports used for media room are added to the local VLAN, with the local network shared with multiple NAT instances that route local traffic to the VLANs configured to provide service to the connected media room device. In this model the management and voice VLANs are unchanged because these are not attached to LAN ports. All data and video traffic is routed at the CPE from the local VLAN to upstream VLAN (no bridged Internet), and the local VLAN will be configured to assign IP addresses to all media devices using DHCP.

Since the basic provision mechanism is the same as provisioning services without media room, the provisioning flow will not change but several configuration fields required to support media room are added to General, Internet and Video and profiles.

7.6.10.1 RG General Profile

When the iMG is configured for media room, the LAN ports that participate are expected to be shared where local media devices can be connected to any of the LAN ports and get service as normal. In this configuration a new service is configured for a LAN port called “Internet/Video” to indicate that the port can be used for video or data traffic. Refer to the following figure.

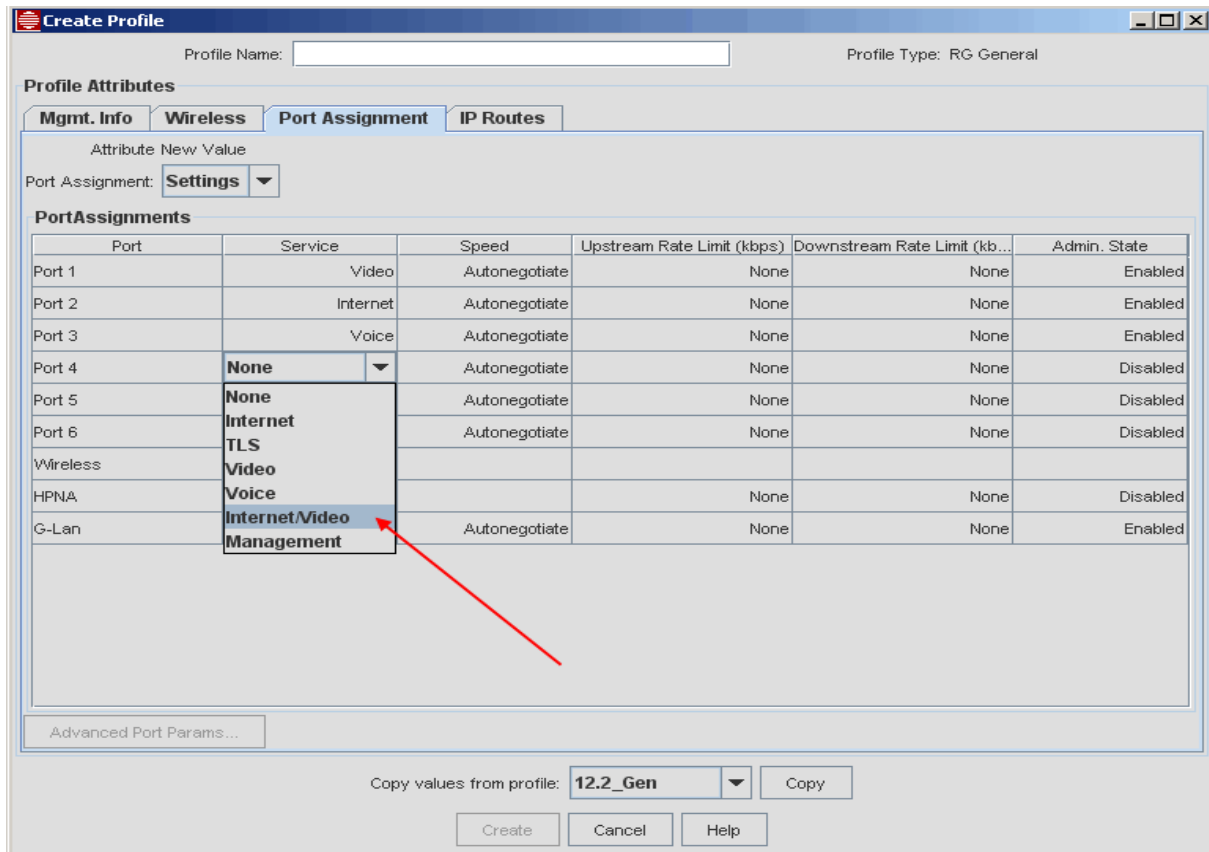

FIGURE 7-90 Port Configuration for Media Room - Internet/Video Service

Using this shared service also configures multicast acceleration for the port so that multicast traffic can be sent to the upstream VLAN that is configured for multicast acceleration.

Note: The Internet/Video service does not change Internet/Video (Tagged) service available on HPNA ports

The routes table in General profile allows up to 10 different routes in the iMG because media room devices connected to the iMG may request services configured in separate subnets on the upstream network. Refer to the following figure.

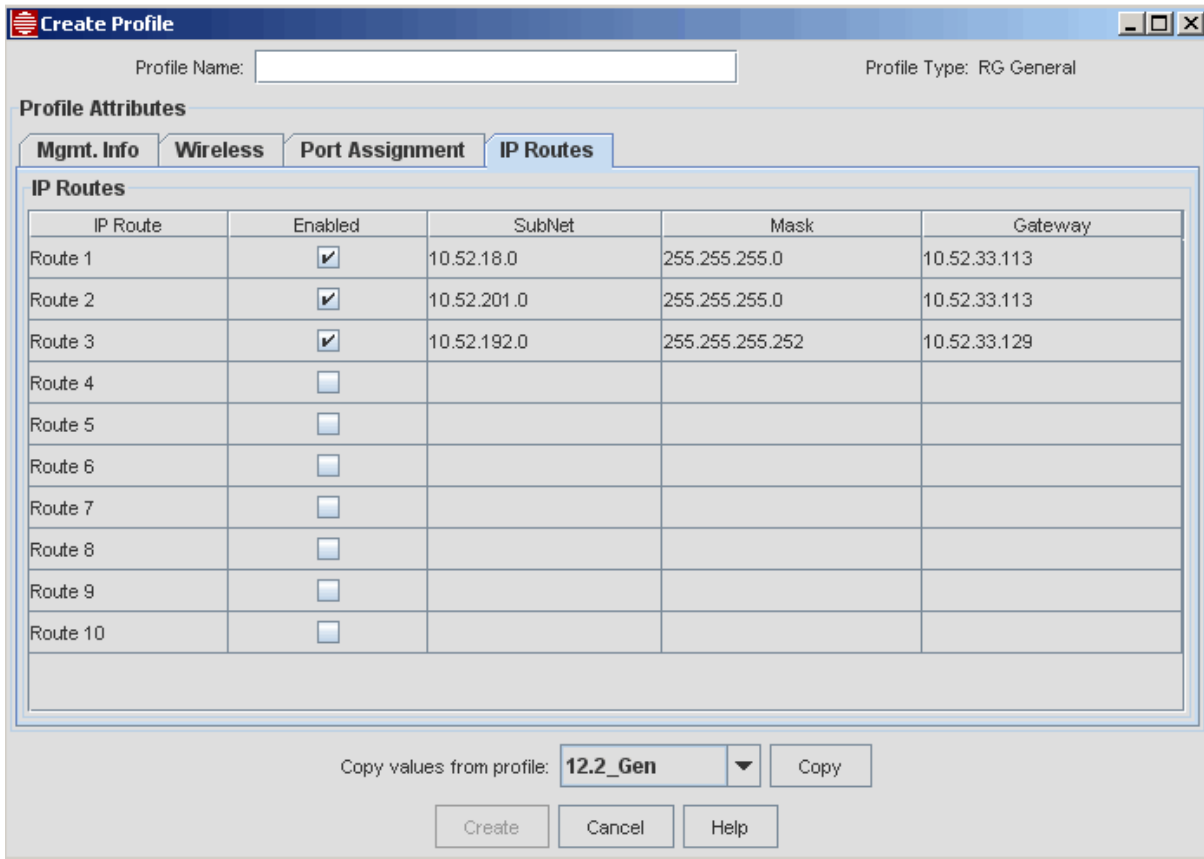

FIGURE 7-91 IP Routes for Media Room - Routes

7.6.10.2 RG Internet Profile

On the Internet Profile with the Security tab there is the field “Rapid Route” that is used to configure the iMG for media room support. This enhances NAT routing functionality in CPE for better throughput of routed traffic. Refer to the following figure.

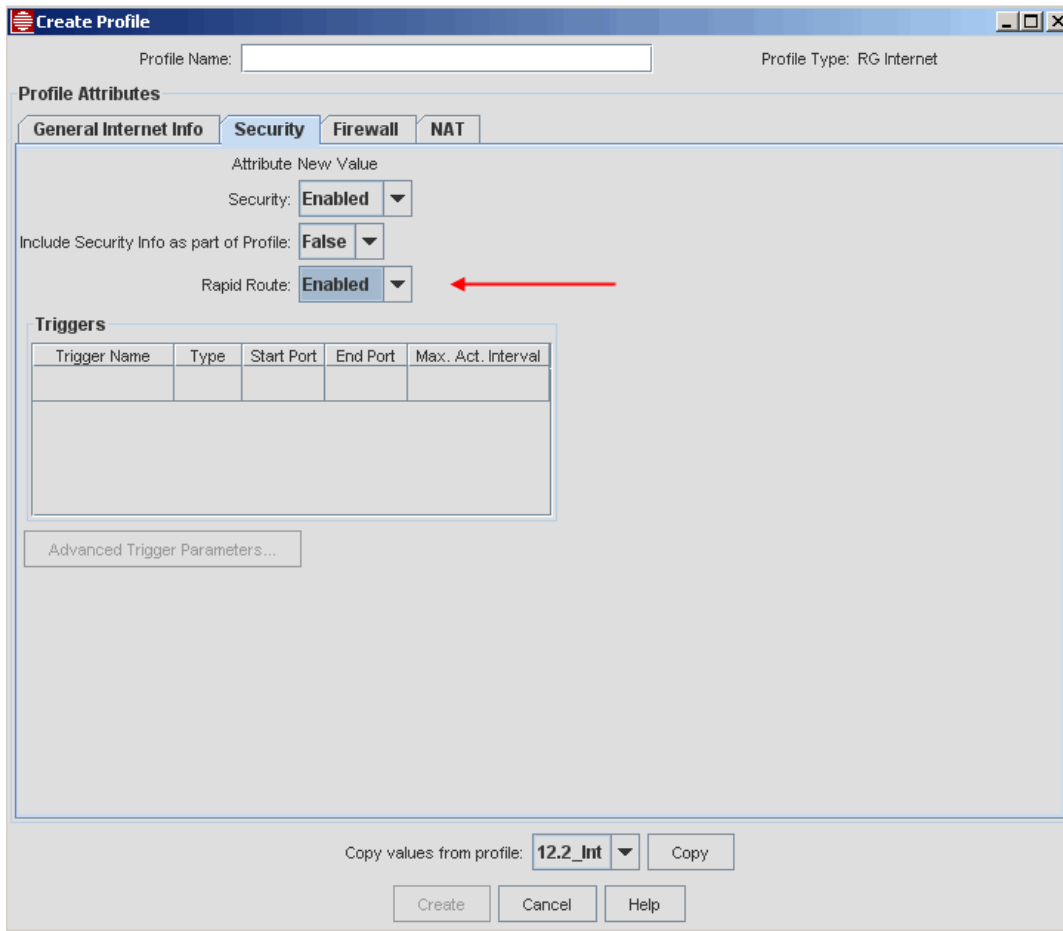

FIGURE 7-92 RG Internet Profile - Rapid Route for Media Room

7.6.10.3 RG Video Profile

The video profile includes two fields needed to support the media room configuration. Since Media Room services are routed, the video profile allows obtaining the IP address for video service using DHCP since this must be a valid reachable IP address. The IP addresses for video interface can also be set on the Triple Play Provision window or after provisioning using the View/Modify Details window.

Note: The IGMP Mode must be set to Proxy to set the Use DHCP to obtain WAN IP address.

The Multicast acceleration field is added to the video profile; when enabled this will configure the upstream VLAN so that multicast traffic can travel across multiple VLANs (the Local VLAN and upstream Video VLAN).

Note: This only enables multicast acceleration to the VLAN. The LAN ports association to multicast acceleration is done when the LAN ports are configured to use 'Internet/Video' shared service, because using a shared port for multiple services indicates intention to use the Media Room configuration.

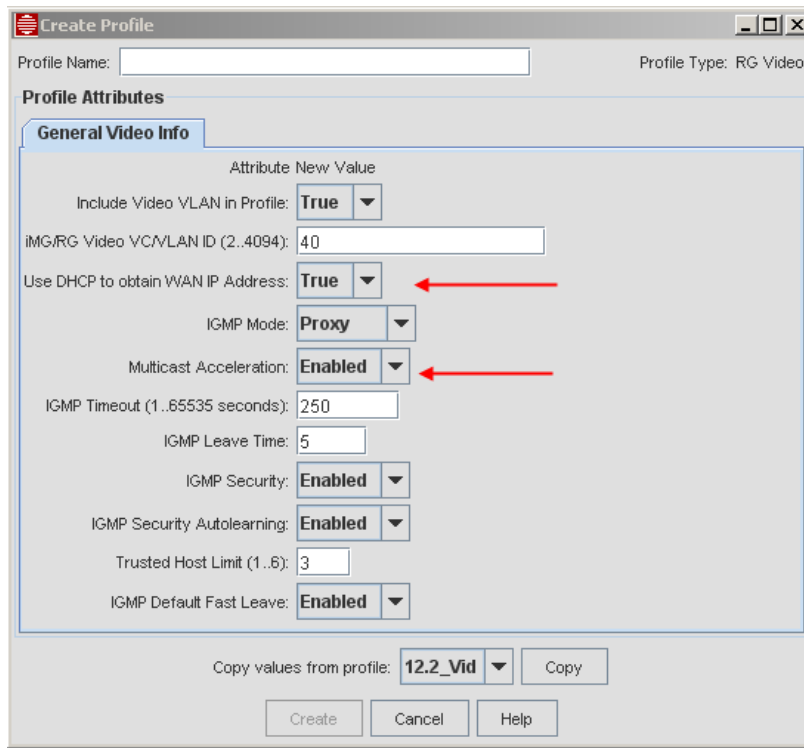

FIGURE 7-93 RG Video Profile for Media Room

7.6.10.4 Summary of Main Steps

Following are the changes grouped by profile.

- General Profile
 - Select Internet/Video service for all LAN ports that are to be used for media room devices
 - Add routes to all services that aren't assigned through DHCP to upstream router as needed
- Internet Profile
 - Select Routed Service and set VLAN IDs and other required information.
 - Enable Security setting under Security tab.
 - Enable Rapid Route setting under Security tab.
 - Enable NAT configuration under the NAT tab.

- Set local IP addresses in General Internet Info tab.
- Video Profile
 - Set IGMP mode to Proxy.
 - Enable Use DHCP for Video IP interface so that it is not necessary to always specify a valid IP address.
 - Enable Multicast Acceleration parameter.

After configuring all profiles, the user provisions the iMG using the Triple Play form and profiles are included as with other configurations. Since media room features are used in iMG 3-8 and above only, if these profiles are used on old iMGs/RGs or on those that do not support media room, the non-supported configuration will not be applied and LAN ports will be configured for routed Internet service.

The following iMGs do not support Media Room:

- RG613-TX/TXJ/BD/SH/LH
- RG623-TX/BD/SH/LH
- iMG613-RF
- iMG616-BD/SH/LH/RF/RF+/SRF+
- iMG624-A/B
- iMG634-A/B
- iMG634-WA/WB

7.6.11 Configuration 10 - Video with static IP Address (iMG1000 and 2000 Series)

In most networks, routers for security reasons will not accept source ip addresses of all zeros or will ensure that the igmp traffic (including joins/leaves) has a proper IP address. When setting up video service, the NMS administrator can set the IGMP Mode to Proxy, but must then either:

- Set the “Use DHCP to obtain WAN IP Address” to True
- Set the “Use DHCP to obtain WAN IP Address” to False, but include a static IP address and mask.

Note: For the iMGs with 3-8 loads, the IP address used is the iMG Mgmt IP.

Refer to the following figure for the Video Profile attributes.

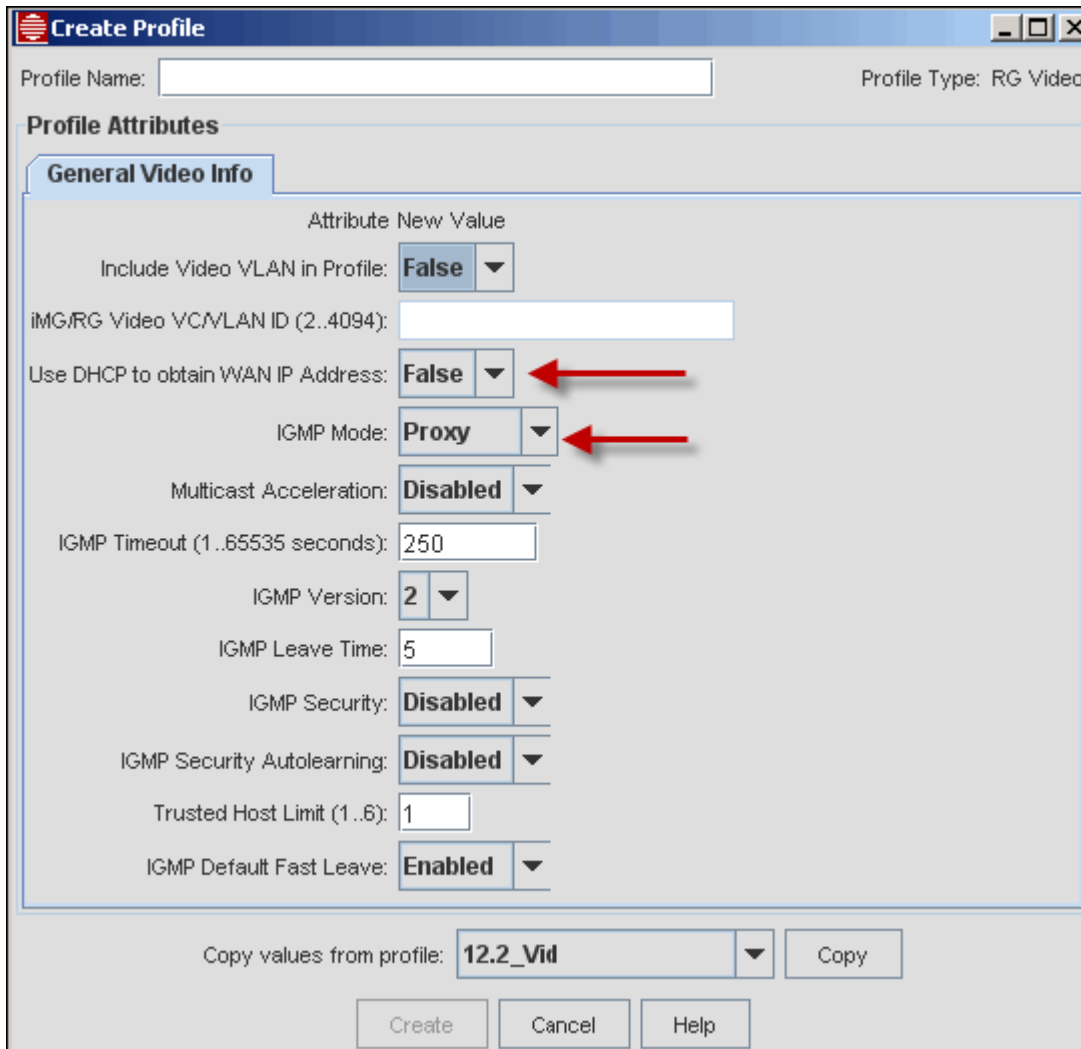

FIGURE 7-94 Video Profile for Proxy Mode (Use DHCP Option = False)

When filling out the Triple-Play form, the administrator should select Display Preferences and select the tic-box VideoIP Address Panel. The user can then fill in a static Video IP Address and Mask, which allows video to work. Refer to the following figure.

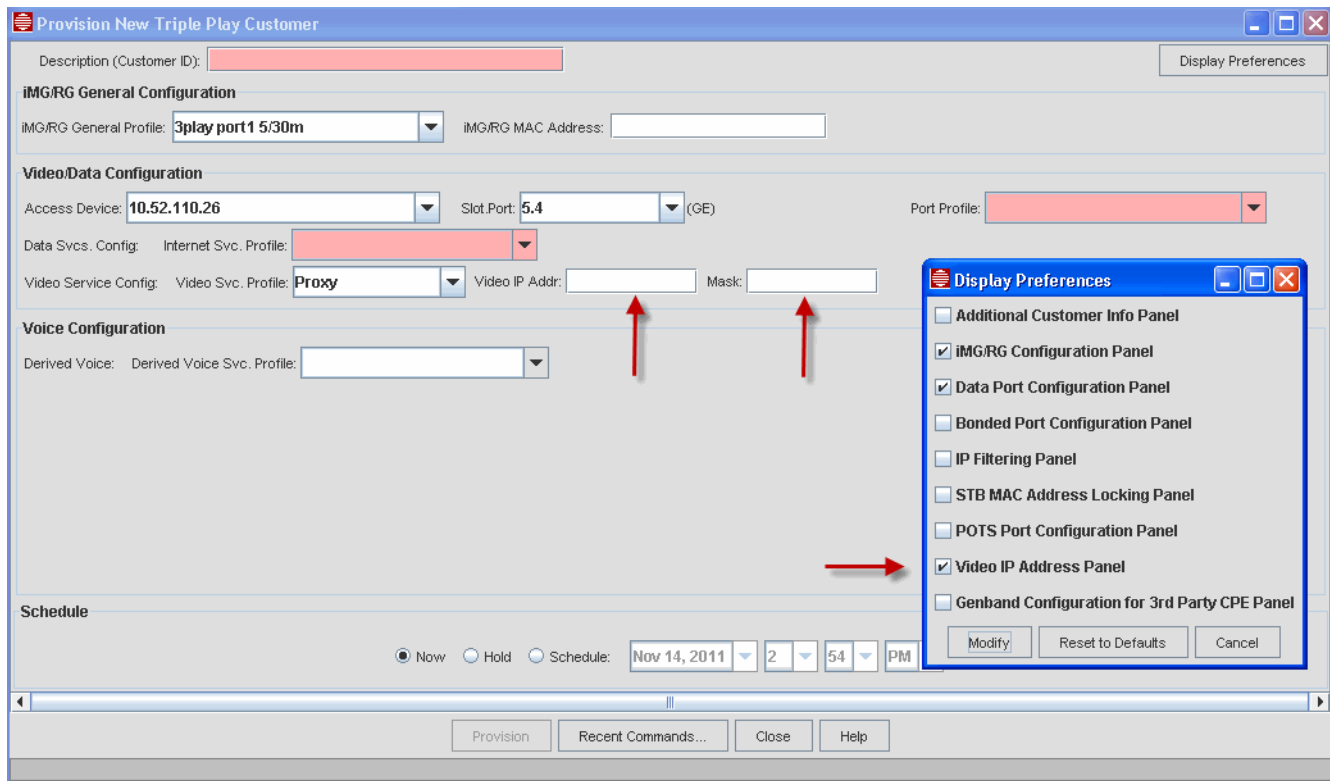

FIGURE 7-95 Showing the Video IP Address Panel (Display Preferences Option)

Once configured, the *iMG/RG* -> *Video Service* tab shows the Video IP Address and Video IP Mask, as shown below.

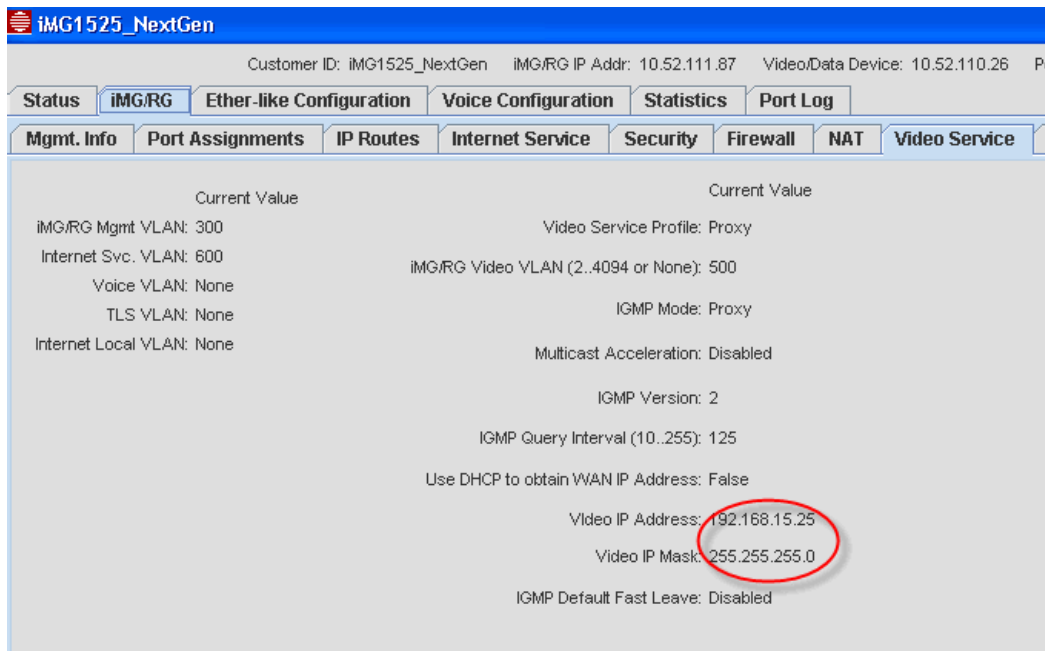

FIGURE 7-96 Configure iMG with Static Video IP Address

7.7 Provisioning the iMG/RG (Managed Object Properties)

7.7.1 Overview

- Managed Object Properties for the iMG/RG

Section 8 of the AlliedView NMS User Guide describes all the relevant managed objects and their properties so that the user can control how the MO is provisioned. This is especially helpful in understanding how MO properties can be filtered in Custom Views.

- Custom Views

As explained in 7.2.2, an Access Island is a group of up to eight iMAPs (with one hub) that are used for a Service Location. In most cases, being able to identify the components specific to an Access Island helps in provisioning current and future subscribers as well as troubleshooting problems.

The example Custom Views in 7.7.3 should be created for each Access Island.

7.7.2 Managed Object Properties for the iMG/RG

As mentioned above, Section 9 lists the properties for the MOs. The following figure and table explain the properties for iMG/RGs and is useful in both provisioning and the iMG/RG and creating Custom Views.

Note: For SysName, SysLocation, and SysContact, NMS checks for up to 255 characters, and outputs a specific error message if more than 255 characters are input. If the device allows a maximum of less than 255 characters, NMS will still flag the mistake but the error message is a more generic “webserver: Value too long”.

Customer ID	IP Address	Type	Release	Upstream Port
SpiderMan	172.16.33.187	RG634-A	3.3.0-61	dot18.nms.telesyn.corp_10.5
	172.16.33.184	RG624-A	3.4.0-27	dot18.nms.telesyn.corp_10.1
UltraLord	172.16.33.181	RG656-BD	2.3.0-59	dot18.nms.telesyn.corp_6.0
CaptainAmerica	172.16.33.180	RG634-A	3.3.0-61	dot18.nms.telesyn.corp_10.14
Multiman	172.16.33.186	RG613-LH	2.3.0-59	dot18.nms.telesyn.corp_6.1

AlliedView Managed Object Properties

BASE PROPERTIES

Name:

Type:

Classname:

Status:

Managed:

IP RELATED PROPERTIES

IpAddress:

Netmask:

ParentNet:

InterfaceList:

STATUS RELATED PROPERTIES

StatusUpdateTime:

StatusPollEnabled:

StatusChangeTime:

PollInterval:

FailureCount:

UserClass:

Tester:

FailureThreshold:

FIGURE 7-97 Managed Object Properties Form for an iMG/RG

TABLE 7-29 Managed Object Properties for Nodes

MO Form Property	Description for Nodes	Custom Map View Property	Example
Name	The device name, which is a unique name that is used as the key in the database. This name cannot be changed.	name	172.16.33.11 or DVLKND-AI01* (sets scope for Access Island 01)
Type	The type of the object, such as whether it is a network, node, or an interface object, or something user specified, like router, switch, etc.	type	9700 9400 Rapier* (all Rapier devices) RG* (all RG devices)
Managed	A checkbox that indicates whether the managed object is managed by the NMS. When checked, the object is being managed by the NMS. Otherwise, it is not.	managed	true (would not include devices that were discovered and unmanaged)
IpAddress	The unique address assigned to each and every object.	ipAddress	172.16.33.11
Netmask	The netmask that is specified for this managed object. Network masking is a methodology by which the elements in a network can be meaningfully categorized.	netmask	255.255.255.0
ParentNet	The ID of the network that contains this node or a list of network numbers if this is a router connecting two or more networks.	parentNet	172.16.33.0
InterfaceList	A non modifiable drop-down list of all interfaces on this device.	InterfaceList	172.16.33.20 172.16.33.21 (The value all would select all nodes.)
Tester	The type of testing to run when checking the status of the device. Refer to the AlliedView NMS Admin Guide, section 9.8.		
Community	The community string of the corresponding SNMP agent associated with the link	community	
SysName (Internal)	The system name as reported by the SNMP agent		
SysDescr	The value of the system description associated with the type of managed object to be filtered.	sysDesc	Telesis 9700 all
SysOID	The system object identifier of the device as reported by the SNMP agent of the device.	sysOID	.1.3.6.1.4.1.207.1.15.3
Login	The CLI username to use when NMS executes CLI commands on the device. It is defaulted but it should be changed.	login	officer
Password	The password to use when NMS logs in with the CLI username.		klk3kdr3

TABLE 7-29 Managed Object Properties for Nodes (Continued)

MO Form Property	Description for Nodes	Custom Map View Property	Example
SysLocation	A string value to identify where the device is located	sysLocation	Building_A (This would assume the device was located in Building_A)
Category	The family of the device	category	Telesis (includes all MAP devices) Rapier* (all Rapier devices) RG* (all RG devices)
Release	The release ID of the device software.	release	
InetProfileMOName	The unique DB names of the Internet profiles associated with this RG		
RgGenProfileMOName	The unique DB names of the General profiles associated with this RG		
VoipProfileMOName	The unique DB names of the voice profiles associated with this RG		
VoipProfileName	Display names of the RG Voice profiles currently associated with this RG		
RgGenProfileName	Display names of the RG General profiles currently associated with this RG		
VideoProfileName	Display names of the RG Video profiles currently associated with this RG		
InetProfileName	Display names of the RG Internet profiles currently associated with this RG		
SysContact	A string to identify the owner of the device	sysContact	Company_A
ConfigChanged	The time that a change to the device's configuration has been detected by the Device Backup operation. Config changes will be detected automatically when recurring backups are scheduled. This property is included in the Nodes custom view under the Network Inventory by default.	configChanged	
LastBackupTime	The time of the last backup performed for this device via the Device Backup/Restore MDTI Operation.	lastBackupTime	Wed Aug18 2004*
MacAddr	The MAC Address of the RG		
RgCustomerID	The unique customer ID for the RG		
Source			DVLKND-mgc1* (G6)

Note: The attributes ending in ProfileName are the display names of the profiles currently associated with this RG. The attributes ending in ProfileMOName are the unique DB names of the profiles associated with this RG.

TABLE 7-30 Managed Object Properties for Ports

MO Form Property	Description for Ports	Custom Map View Property	Example
Name	The device name, which is a unique name that is used as the key in the database. This name cannot be changed.	name	172.16.33.11 or DVLKND-AI01* (sets scope for Access Island 01)
Type	The type of the object, such as whether it is a network, node, or an interface object, or something user specified, like router, switch, etc.	type	7700 (Only 7700 would be included) Other values are: 9700 9400 (all Rapier devices) RG* (all RG devices)
UpstreamDevicePort	The <Map Name>_slot.port of the port that the RG is connected to.		
SubType			*Gigabit*

7.7.3 Creating Custom Views for an Access Island

When the iMG/RG is first provisioned, it is not included on the Physical Map, but in the RG’s subnetwork. The RG is also placed in the Network Inventory view under iMG/RGs, and includes the slot.port of its upstream iMAP.

As shown in Figure 7-1, the network should be divided into Access Islands, each with its Hub iMAP and Node iMAPS with their subtending iMG/RGs. Starting from the initial views of the iMG/RGs, the network administrator should create Custom Views that highlight the components of an Island. This makes provisioning and monitoring of the Island much easier.

Note: Refer to Section 9 of the AlliedView NMS User Guide for a listing of all managed object properties that can be used to create custom views and examples.

Note: Do not to use special characters in a view name, or an error will result

Following are the main rules when defining criteria (a more complete list is in Section 9 of the AlliedView NMS User Guide).

- For string-based properties, the string value is absolutely matched. For example, the string “Router” matches the exact word only.
- The wildcard '*' (asterisk) is supported to replace one or more characters. For example, if you want to view objects whose names start with 'sa', then you have to specify it as 'sa*'. Similarly, if you want to view objects whose names end with 'com', then you have to specify as '*com'.
- Wildcard, '?' is not supported and is treated just as an ordinary character.
- For specifying multiple criteria for the same property, separate them with a comma. For example, if you want to view objects named nms-server1, nms-server2 and nms-server3 then specify as nms-server1, nms-server2, nms-server3.
- To exclude certain items, as part of the filtering criteria, append a '!' before it. The exclamation mark should be used to ignore those values. For example, if you want to view objects, which do not start with 's', then specify the property as '!sa*' or if you want to see all Alarms, except those with severity other than warning and clear, then any of the following will work:
 - !war*, !cle*
 - !warning, !clear
 - cr*, maj*, mino*

- critical, major, minor

Click on the **More** button and then **Select Additional Criteria** to include more attributes that will filter this form. Use the exact name for the criteria and follow the rules above. You can also choose Select Props to View to select which fields will appear in the view. (This is different than defining the criteria to filter a view.)

Figure 7-98 shows the AlliedView NMS as it is configured for an Access Island (called AccessIsland_1)

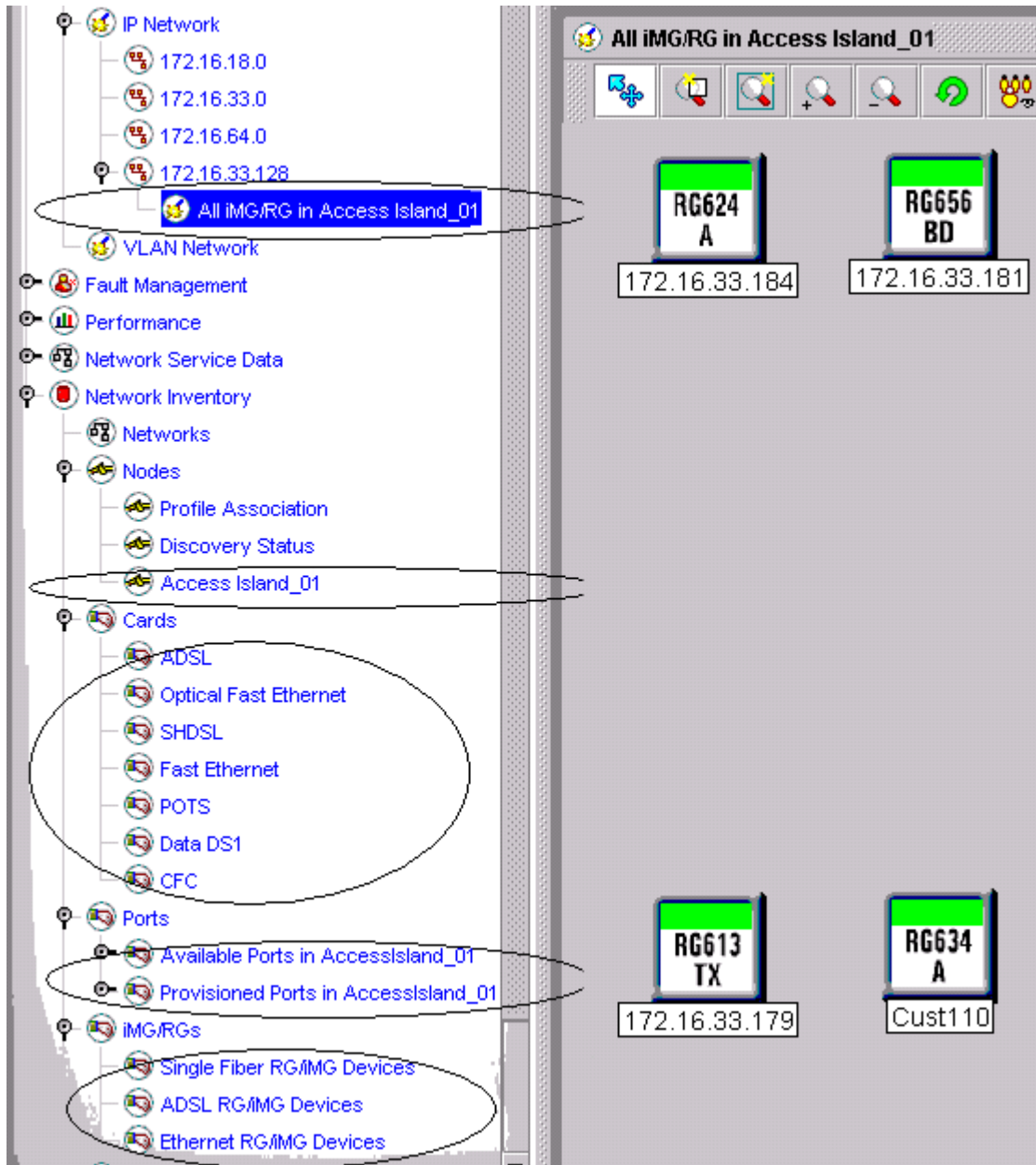

FIGURE 7-98 Custom Views for iMG/RG Management (Access Island 01)

7.7.3.1 All iMG/RGs in an Access Island (in IP Network Map)

As shown in Figure 7-98, there is a Custom Map View for all iMG/RGs for Access Island 1 that shows all iMG/RGs that are part of this Access Island. To create this Custom View, perform the following steps:

1. Select the Network Node that will have the Custom View as a sub-node (this can also be done later).
2. Right click on this Node and select *Custom Views -> Add Custom Map* (or Control-N)
3. On the Map Properties form, fill in the Name you wish to give this Custom Map. (You can also choose the parent node here if you wish to change this.)
4. Click on the **More** button and the Select Additional Criteria to include more attributes that will filter this form. The following figure shows which attributes are used, **ClassName** (RgMO), and **UpstreamDevicePort**, with a criteria that selects all the subtending nodes in the Access Island.

Note: You must create or “manage” all rgmgmt IP subnets beforehand; The NMS learns of RG's via “DHCP” or “Discover Attached iMG/RG” otherwise they will not show up in the any IP subnet MAP.

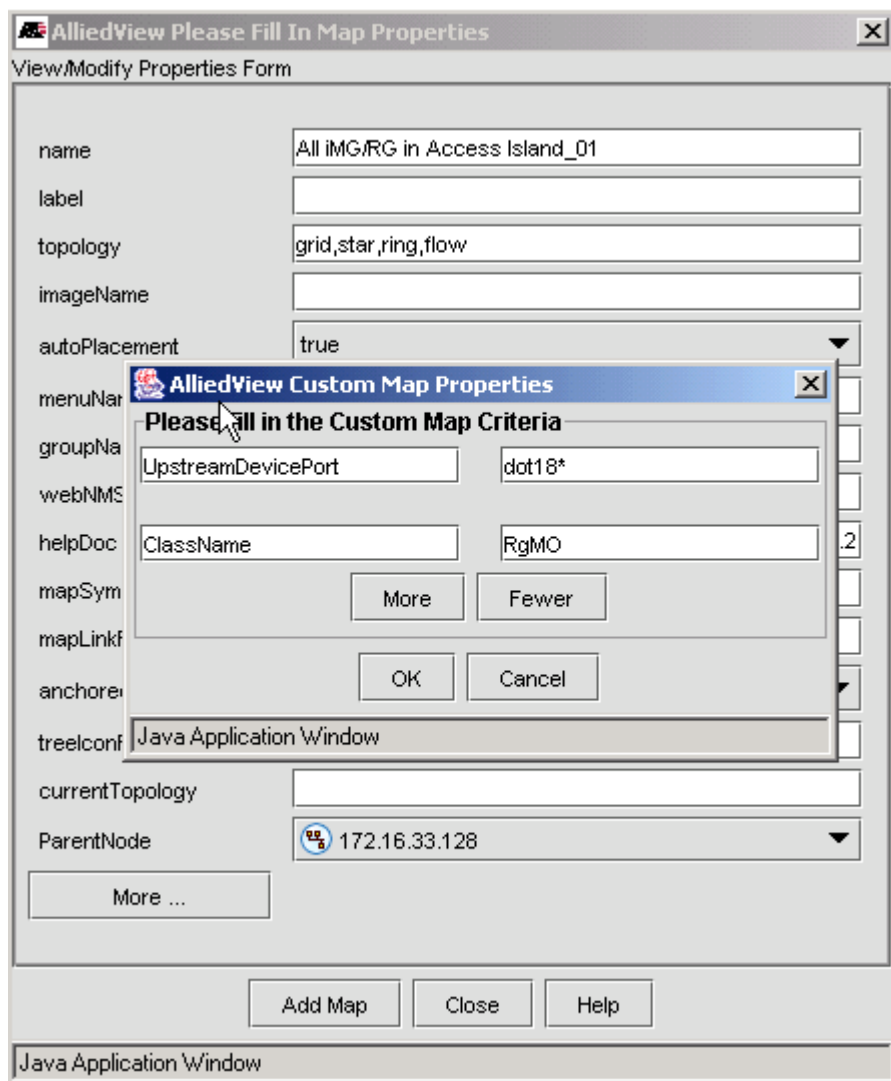

FIGURE 7-99 Custom Map for iMG/RGs in an Access Island

7.7.3.2 All iMAP Nodes in an Access Island

In the Nodes view of Network Directory tree, a Custom View can be created that includes all the iMAPs for an Access Island. To create this Custom View, perform the following steps:

1. Select Nodes under Network Inventory.
2. Right click and select *Custom Views -> Add Custom View* (or Control-V)

- On the Object Properties form, fill in the Name you wish to give this Custom View. (Note that in this case you cannot choose the parent node.)

Click on the **More** button to include the attributes that will filter this form. The following figure shows which attributes are used, not **classname** (!RgMO), and **ipAddress** (if all iMAPs for the Access Island are in the same subnet), with a criteria that selects all the iMAPs in the Access Island.

Note: You can click on Name as well, using a name such as DVLKND-AI01* if using the naming convention suggested in this Section.

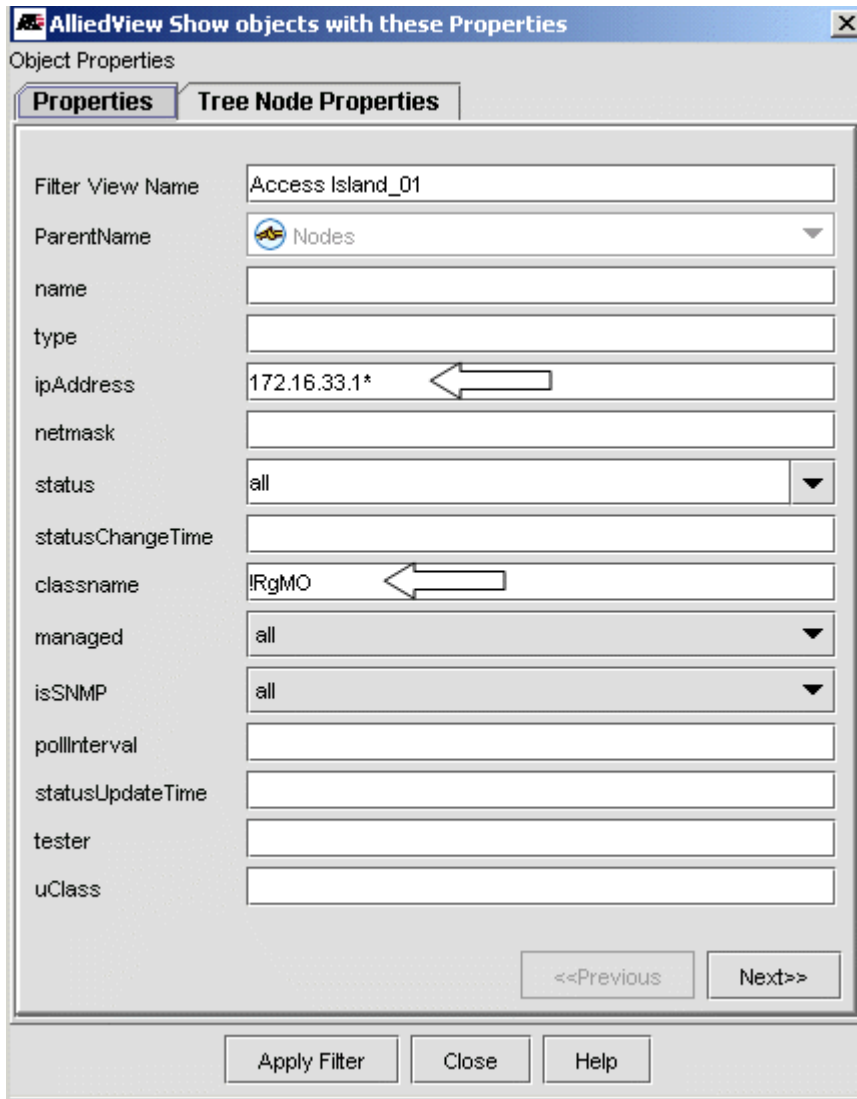

FIGURE 7-100 Creating a Custom View for all iMAPs in an Access Island

7.7.3.3 iMAP Cards Grouped by Type

To create Custom Views for each card type, create Custom Views with the following filtering criteria.

- ADSL - cardType=ADSL*, type=Card
- Optical Fast Ethernet - cardType = FX*, type=Card
- SHDSL - cardType=SHDSL*, type=Card

- Fast Ethernet - cardType=FE*, type=Card
- POTS - cardType=POTS*, type=Cardtype=Card
- VDSL - cardType=VDSL*, type=Card

Note: For a complete list, refer to the AlliedView NMS User Guide.

The screenshot shows a dialog box titled "AlliedView Show objects with these Properties". It has two tabs: "Properties" and "Tree Node Properties". The "Properties" tab is selected. The dialog contains the following fields and controls:

- Filter View Name: Text box containing "ADSL"
- ParentName: Dropdown menu showing "Cards"
- cardType: Text box containing "ADSL*" with a left-pointing arrow
- name: Empty text box
- type: Text box containing "Card" with a left-pointing arrow
- ipAddress: Empty text box
- netmask: Empty text box
- status: Dropdown menu showing "all"
- statusChangeTime: Empty text box
- classname: Empty text box
- managed: Dropdown menu showing "all"
- isSNMP: Dropdown menu showing "all"
- pollInterval: Empty text box
- statusUpdateTime: Empty text box
- tester: Empty text box

At the bottom right, there are two buttons: "<<Previous" and "Next>>". At the bottom center, there are three buttons: "Apply Filter", "Close", and "Help".

FIGURE 7-101 Example Custom View for Card Types

7.7.3.4 Provisioned / Available Ports in an Access Island

In the Ports node, it is useful to create a Custom View for provisioned and unprovisioned ports, since the administrator could then quickly see the pool of unprovisioned ports that could be used for adding subscribers.

For provisioned ports, the filtering criteria is as follows: (names are for an example customer):

- customerID = ! (logical not, since a provisioned port must have a customer ID)
- type = CustPort
- parentKey = dot18*

For available ports, the filtering criteria is as follows:

- ethIfIndex = <> (null, since an available port does not have an Ethernet index value)
- customerID = <> (null, since an available port does not have a customer ID)
- type = CustPort
- parentKey = dot18* (This narrows the view down to the Access Island.)

An example would be a Custom View that showed all GE ports on Access Island 01. The criteria would be:

- name = DVLKND-AI01*
- SubType = *Gigabit*

Note: Sorting or ordering of these views is not supported, so the creation order is important.

1. create a view of all unprovisioned ports
2. Create two views (unprovisioned/provisioned) per Access Island.

7.7.3.5 iMG/RGs Grouped by Type

Custom Views should also be created for the iMG/RG type, allowing the administrator to isolate an iMG/RG and the services it can provide, as well as which RGs have not been provisioned yet. Example criteria is as follows:

- ADSL - className=RgMO, type=iMG6*4*
- Ethernet - className=RgMO, type=!iMG6*4*
- MOD - className=RgMO, type=*MOD*
- Unprovisioned - className=RgMO, rgCustomerID=<> (null, since a provisioned RG must have a Customer ID)
- Voice - className=RgMO, voipProfileName=!

7.7.3.6 Fault Management

Custom Views should also be created for fault conditions or output. The filtering criteria is as follows:

- Syslog CLI Events - Category = SYSLOG-CLI*

Note: An alarm category of Battery is available, so these battery-related alarms can easily be viewed in the Alarm Summary View in the main AlliedView NMS screen.

- G6 events in last time period (i.e. 24 hours) - refer to the following figure

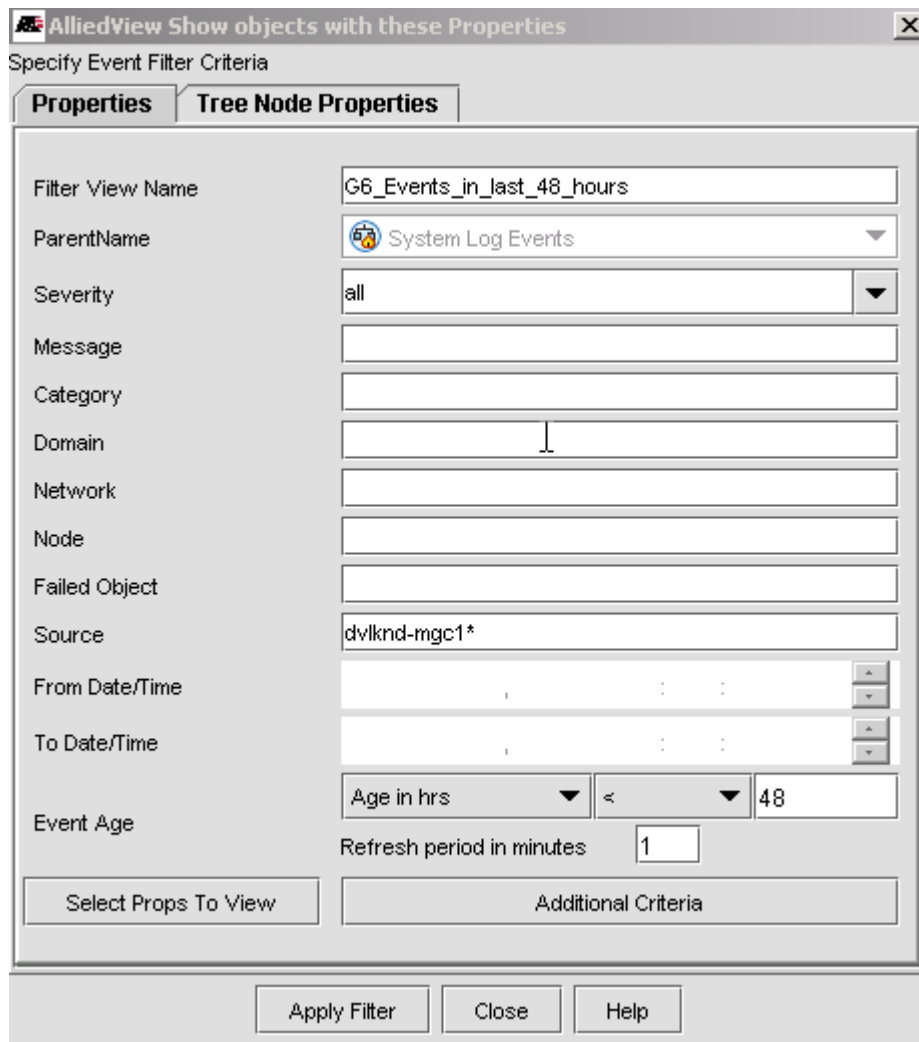

FIGURE 7-102 Custom View for G6 Events in last 48 hours

- All RG/iMG events in the network - Refer to the following figure.

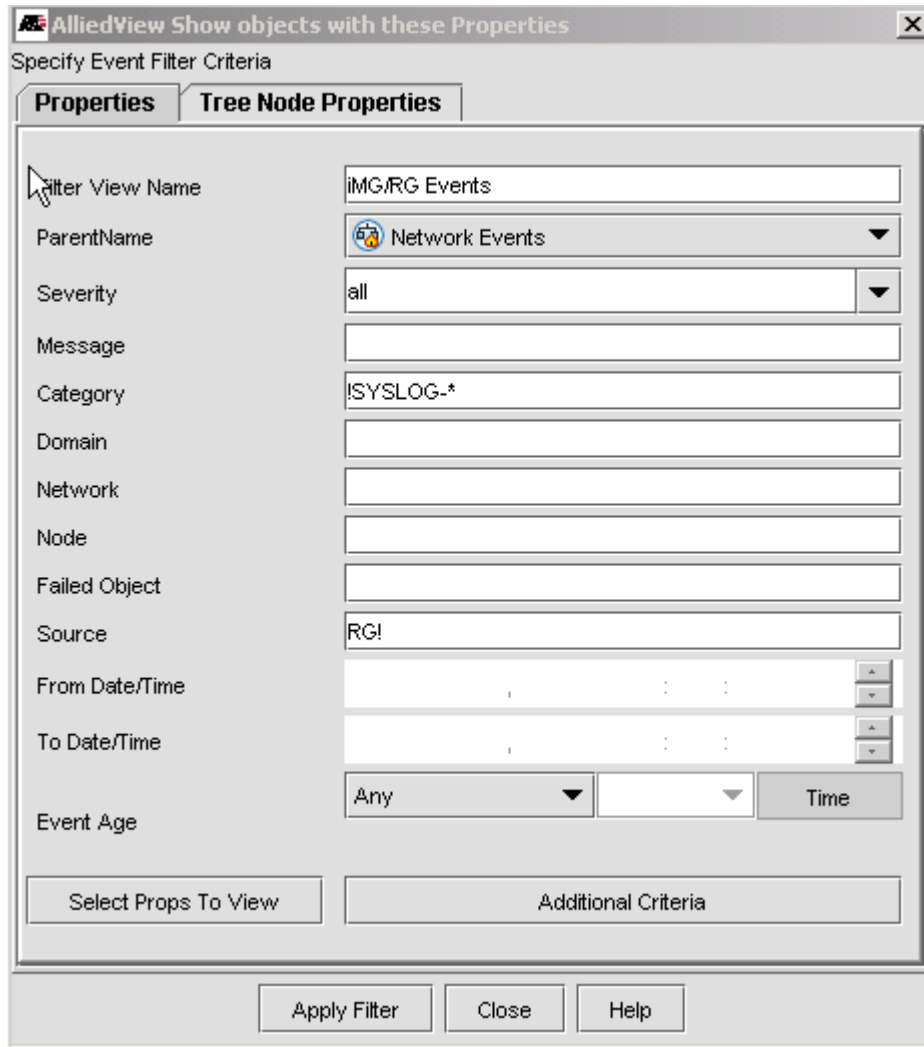

FIGURE 7-103 Custom View for RG/iMG Events

7.8 Provisioning the iMG/RG (Application Manager)

7.8.1 Overview

Caution: If AlliedView NMS users are accessing applications via an IP route that includes Network Address Translation (NAT), certain AlliedView NMS modules may not work correctly as the server may send information to the clients over different ports than those initiated by the clients. Users should therefore set up a FE on the back side of the NAT or remove the NAT process to prevent this.

As described in 5.3, the Provisioning Application for Allied Telesis devices allows the administrator to control software related tasks (backup/restore, command scripting, SNMP, file management, etc.). This same provisioning GUI can be used for the iMGs/RGs as follows:

- The tasks available are Device Backup/Restore, Device Configuration, and Software Configuration
- The GUI has a device type selection button, **NETWORK** and **CPE**, that allows the administrator to choose one type of device or another. This allows the administrator to focus on only one type of device at a time, an important capability since there may be thousands of iMG/RGs and a much smaller number of Allied Telesis devices.

The way to access the Application Manager is unchanged

- Right-click on a device (as an icon or table row), and select **Provision -> (Provisioning Task)**.
- From the main menu, select **Tools -> Application Manager**.

The following figure shows the result when the user selects **Tools -> Application Manager**.

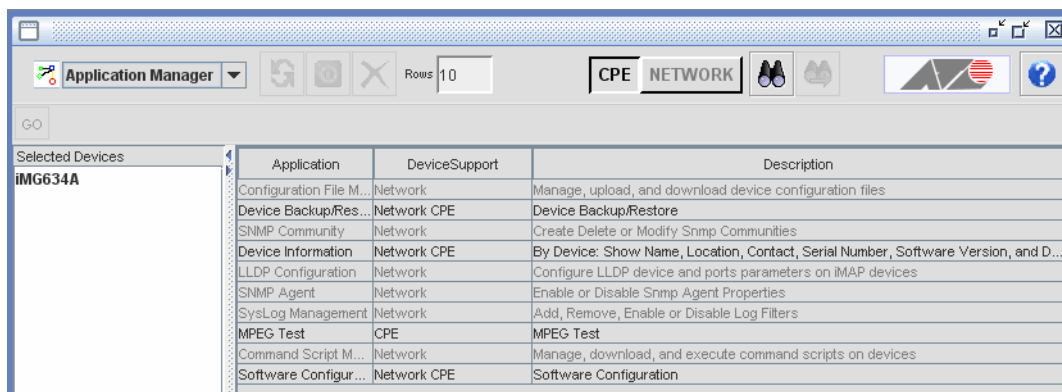

FIGURE 7-104 Application Manager GUI for CPE (iMG/RG)

Note that the user can select the CPE button and only the tasks available are highlighted; the others are grayed out. (The others would be available if the user had chosen **NETWORK**.)

The options available are similar to those for network devices. The user can double-click on one of the Applications in the table (or select the application, and then click **GO**) and it will invoke the specific application window.

If the user clicks **Add/Remove Devices**, which is at the bottom of every application window, the set of (CPE) devices that are to be included in the application can be controlled, as shown in the following figure. Refer to 5.3.1 for details on using the buttons and options.

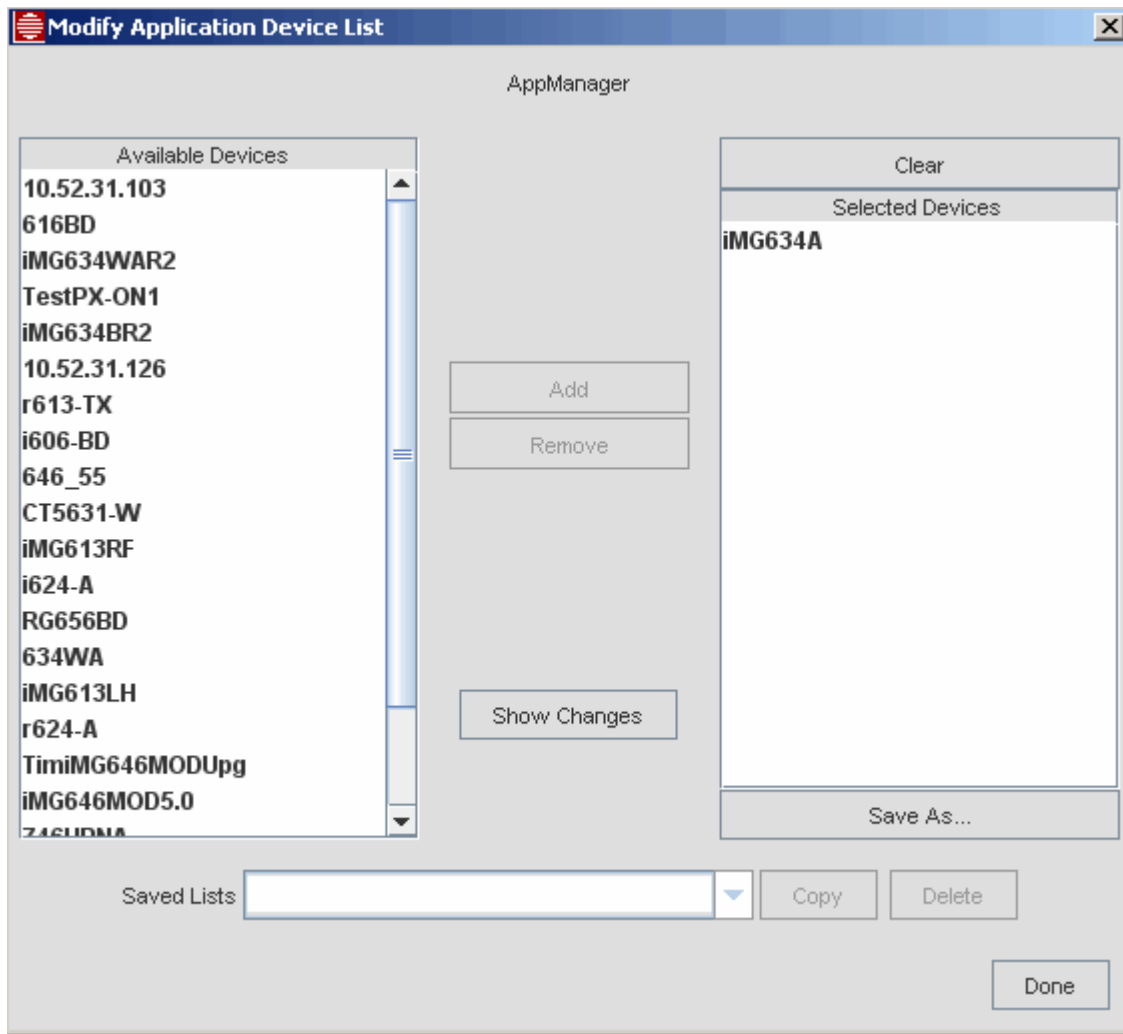

FIGURE 7-105 List of CPE Devices available for an Application

7.8.2 Backup/Restore

This follows the same steps as for Allied Telesis Devices. Refer to Section 5.

7.8.3 Device Configuration

This follows the same steps as for Allied Telesis Devices. Refer to Section 5.

7.8.4 Software Configuration

This follows the same steps as for Allied Telesis Devices. Refer to Section 5.

7.9 Provisioning Guidelines for Models

7.9.1 Open Access

Figure 7-106 shows an example configuration in which there are nine Service Providers, three for each type of service. As a result, there are nine VLANs that exist for these services, and changing a service provider for a service requires a different VLAN to be used.

With the updated iMG/RG profile GUIs in 9.0, the following is done to provision the Open Access model:

- Mgmt. Profile - Set the 'Include VLANs in Profile' to False - The service VLAN fields are de-activated, since these VLANs are now filled in individual service profiles
- Service Profiles - In the Voice, Video, and Internet profiles, set the 'Include <service type> VLAN in Profile' field to True. The service VLANs are activated and can be filled in.

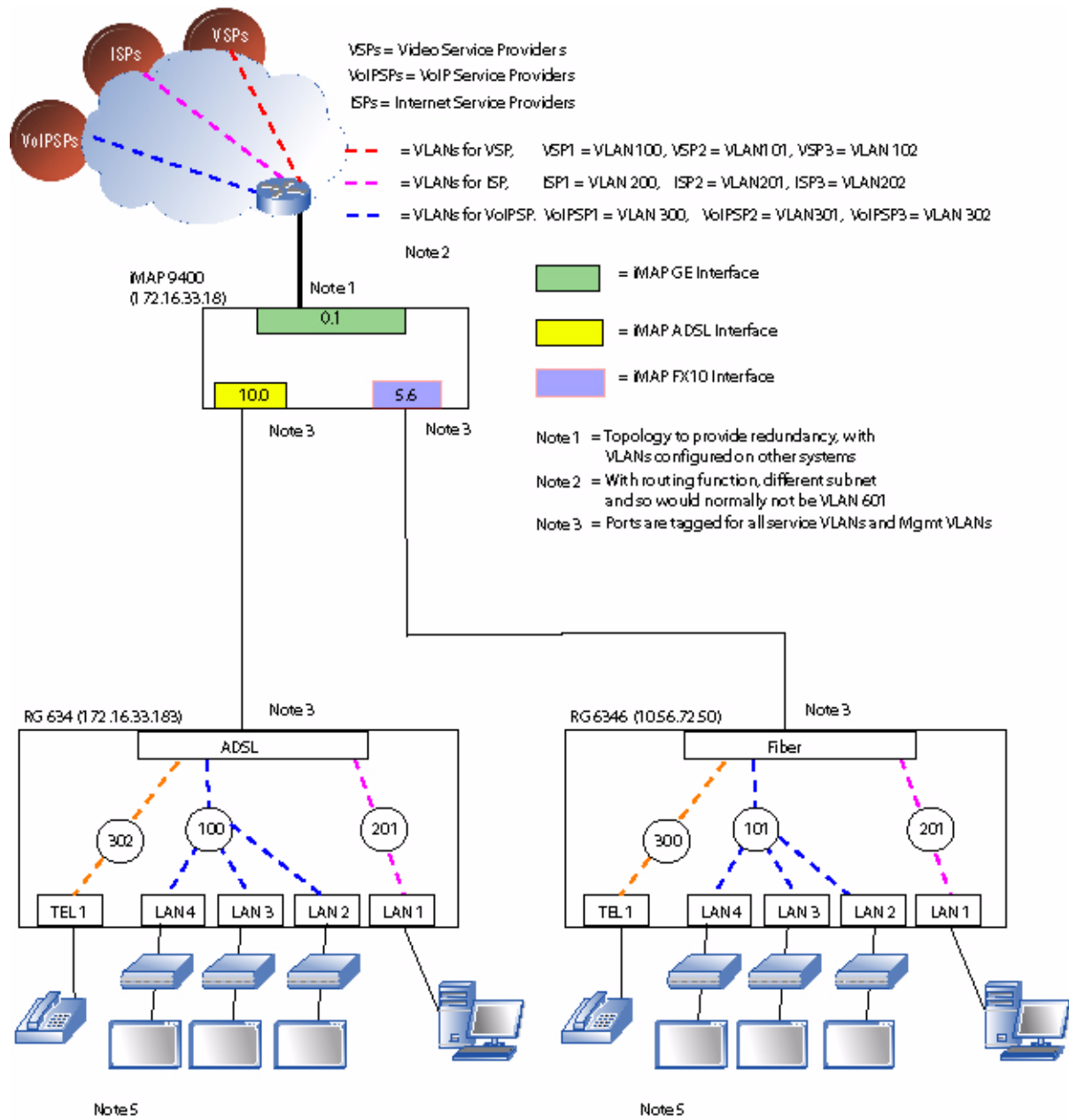

FIGURE 7-106 iMG/RGs in a Network with Multiple Providers for each Service

Once the Open Access model is configured, the Service Management Form is similar to the Access Island model; on the Mgmt. Info tab, the service VLANs are read only, and so the user must go to the individual service tabs to change a VLAN. Refer to the following figure.

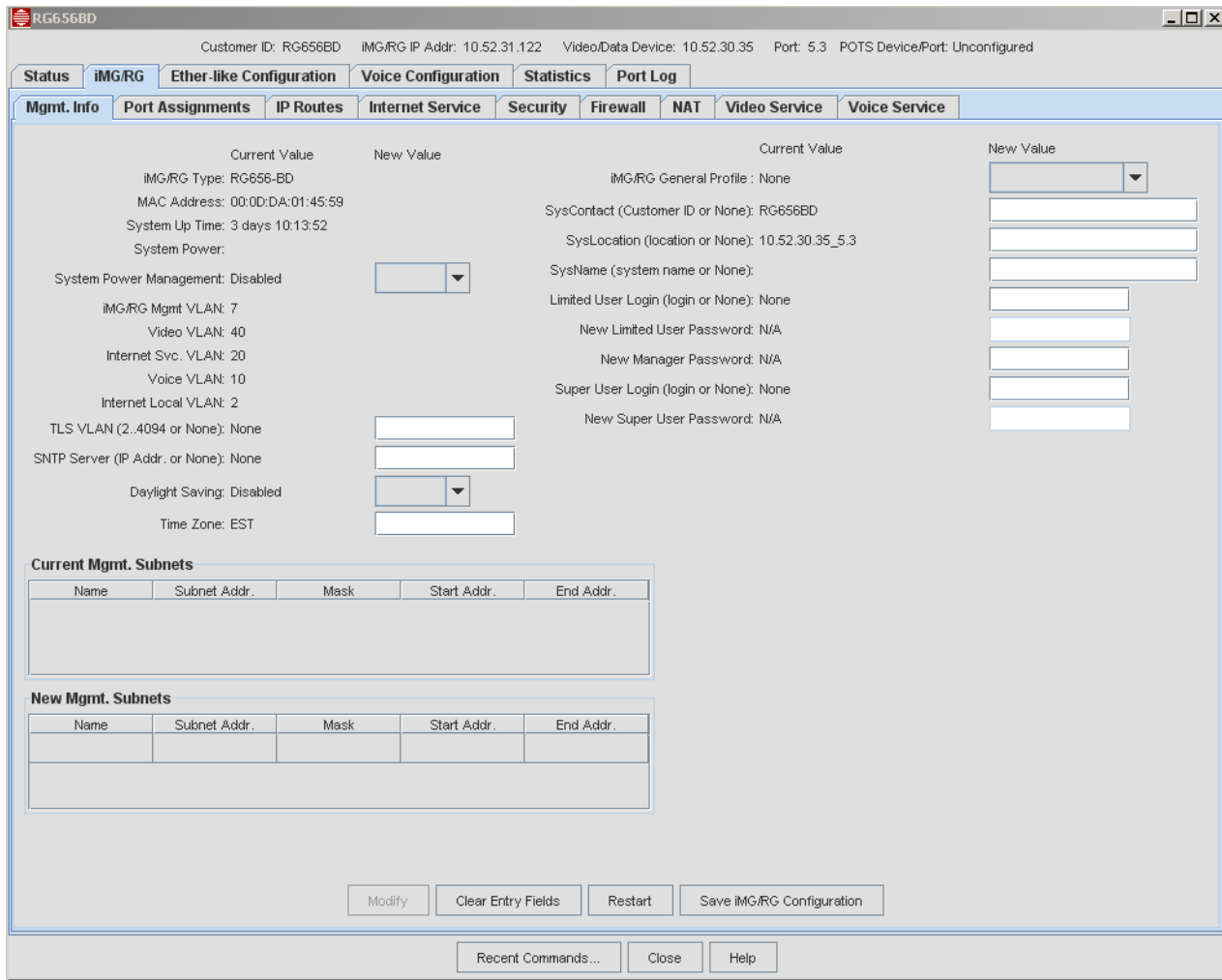

FIGURE 7-107 Service Management - iMG/RG -> Mgmt. Info Tab

7.9.2 Multi-service VLANs

Note the following when provisioning a multi-service VLAN configuration:

- If the internet service is Routed NAT and on the same VLAN as the RG Mgmt VLAN, you must have the Firewall=ON and two port filters to allow TCP and ICMP traffic. Otherwise the NMS will lose connectivity and cannot discover the iMG.
- When moving a service from one shared VLAN to another VLAN, the LAN ports move with the service, so a port for a service for video may, for example, end up with a port as Internet. In the port assignment tab of the RG General Form, the user must look at the configuration and decide which port will have the video. Refer to 7.10.13.
- If you are adding internet service to a working VLAN (which already has DHCP and IP addresses), note the following:
 - If in the internet profile there is a mismatch, you will get an error message.
 - Once the internet service is joined, you can change the DHCP settings.
- If taking internet service out of a shared service VLAN, internet service could be lost. Refer to 7.10.13
- TLS service must always have its own VLAN.
- The local RG VLAN is separate.
- Prior to release 10.0, if Bridged Internet service was configured, the DHCP and IP address/mask fields were grayed out, now they are not, since you may want to add another service such as voice.

7.9.3 iMG6x6MOD/iMG7x6MOD - Translation and HPNA Diagnostics

7.9.3.1 Need for Translation of VLAN Numbering for iMG6x6MOD

With the iMG6x6MOD product, the media converter used between the coax and ethernet interfaces has untagged VLANs on the ethernet interfaces, numbered 201 and 901. The VLANs used on the LAN ports must also have these two VIDs configured.

Note: The HPNA could also be configured to support an untagged VLAN, but this needs to be configured on the default VLAN (1), and the HPNA could support only one service.

Since the upstream network might not be using VLANs 201 and 901 as their VLANs for data and video, the VLAN must be translated to another VID that matches what the network is using. Using this translation feature for iMAP interfaces is available on the Port Profile Form.

7.9.3.2 HPNA Testing Feature

The HPNA card allows the end-user to use the existing Coax cables in the home as part of the home network. One of the problems with this model is the varying quality of the Coax cable and connectors. To help the service provider diagnose problems inside the home, the iMG6x6MOD/iMG7x6MOD provides data on the HPNA network. This feature allows the service provider use the NMS to diagnose problems in their customer's HPNA network.

The feature allows the user to perform the following:

- View the information about the master station (iMG) of the HPNA Network.
- View the information about each of the stations in the HPNA network. This includes the list of hosts (MAC Addr) behind each of the stations.
- View the HPNA statistics for each of the stations in the HPNA network.
- Reset the HPNA statistics for the stations in the HPNA network.
- Request the collection of the HPNA network performance metrics and view the result of the test.
- When requesting the collection of HPNA network performance metrics, the user is warned that this request is service affecting. In addition, user can cancel the request upon seeing the warning before the service is affected.

Note: The performance metrics collection will not be polled. The user must specifically request the metrics collection to be taken.

This feature consists of using four tabs:

1. HPNA network master information - The user can access this tab as follows:
 - The iMG/RG Network Inventory or the IP Network Map, the user can select an iMG6x6MOD/iMG7x6MOD and select the "View/Modify Details" button.
 - From the Triple Management window that is brought up, the user can select the "iMG/RG" tab. This will bring up the General information about the iMG. The user then selects the HPNA sub-tab. This will display the Master Tab containing the information on the master of the HPNA Network.

Refer to the following figure

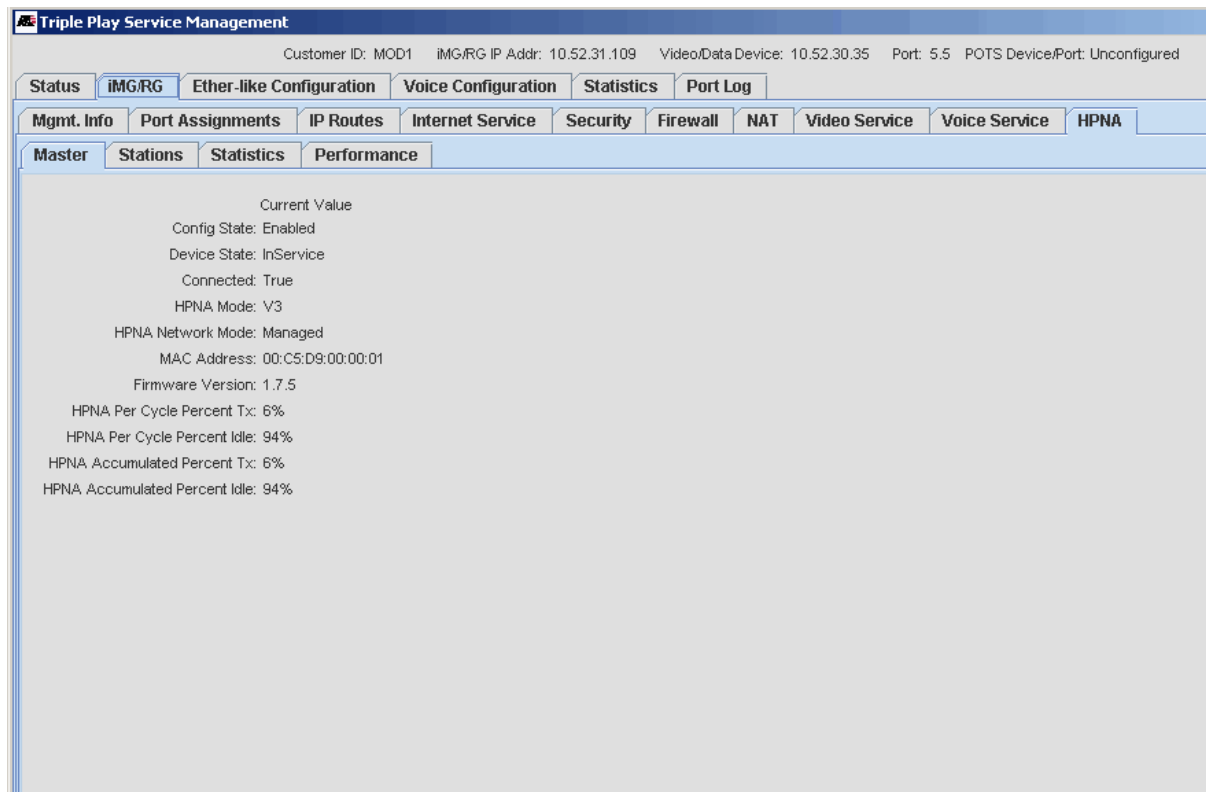

FIGURE 7-108 HPNA Testing - Master Tab

2. View the HPNA network stations information - The user can view the information about the stations in the HPNA network. The information to be displayed is shown in the diagram.

The Stations sub-tab contains the HPNA Network station information. The tab will show a table where each row contains information on a different station including the Station MAC Address, the Link State, the Sync State, the HPNA Mode, the software level, and a list of the hosts attached to that station. Refer to the following figure.

Triple Play Service Management

Customer ID: MOD1 iMG/RG IP Addr: 10.52.31.109 Video/Data Device: 10.52.30.35 Port: 5.5 POTS Device/Port: Unconfigured

Status **iMG/RG** Ether-like Configuration Voice Configuration Statistics Port Log

Mgmt. Info Port Assignments IP Routes Internet Service Security Firewall NAT Video Service Voice Service **HPNA**

Master Stations **Statistics** Performance

Stations: 2 # Devices: 5

Station	Link	Sync	HPNA Mode	Software	Hosts
iMG	Up	True	V3	1.7.5	00:0C:25:15:00:12,00:0D:DA:00:02:B2
00:03:DA:01:0F:1D	Up	True	V3	1.7.4	00:02:02:00:AC:82

FIGURE 7-109 HPNA Testing - Stations Tab

3. View the HPNA network statistics - The user can view the statistics for each of the stations in the HPNA network.

The Statistics Tab contains the HPNA Network station statistics. The tab will show a table where each row is a different statistic and each column is a station in the HPNA Network. The user can press the “Reset Statistics” button, and the HPNA statistics on the iMG are set back to 0. Refer to the following figure.

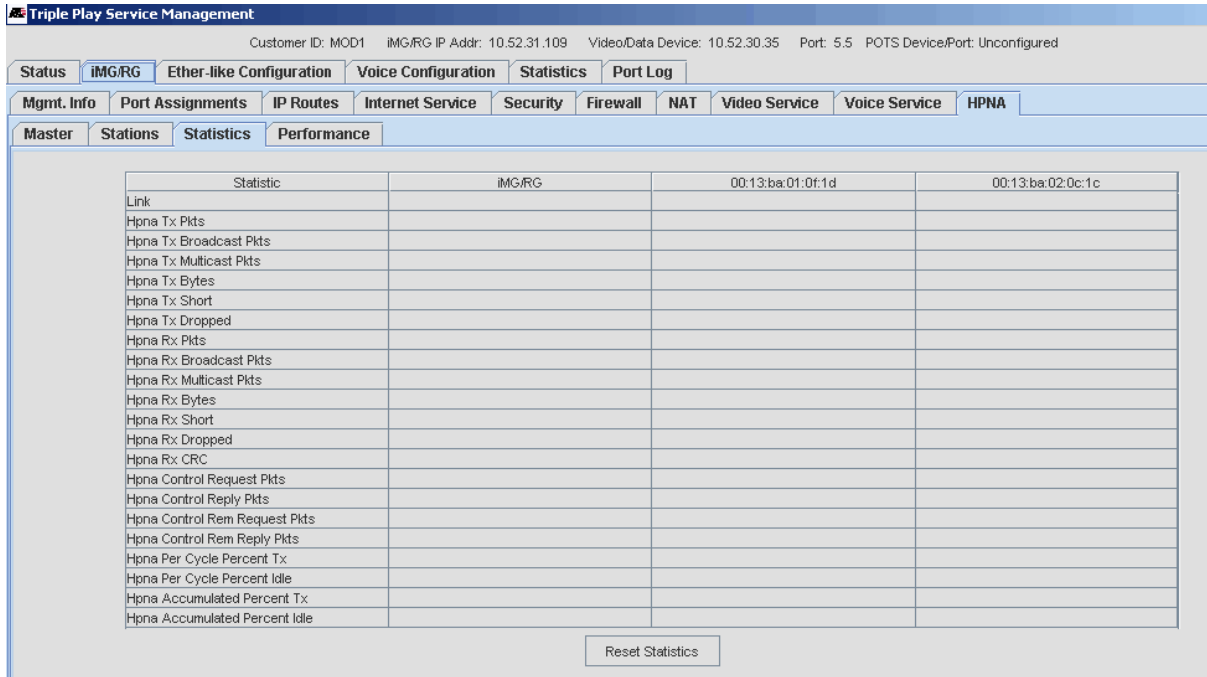

FIGURE 7-110 HPNA Testing - Statistics Tab

4. View the HPNA performance metrics

The user can view the performance metrics between each pair of stations in the HPNA network. The tab will show a table where each row is a different from-station/to-station pair and each column is a metric. The user then presses the “Collect Performance Metrics” buttons to start the data collection. Refer to the following figure.

Endpoints	Packets	Per	SNR(db)	Rate(Mbps)	Rx Power(dBm)
iMG->00:13:BA:01:0F:1D	1000/1000	0	43.06	128 16/8	-2.564
00:13:BA:01:0F:1D->iMG	1000/1000	0	44.8	128 16/8	-5453

FIGURE 7-111 HPNA - Performance Tab

5. Collect Performance Metrics

The user selects the Performance sub-tab and presses the “Collect Performance Metrics” button. This will display confirmation dialog as shown in the following figure.

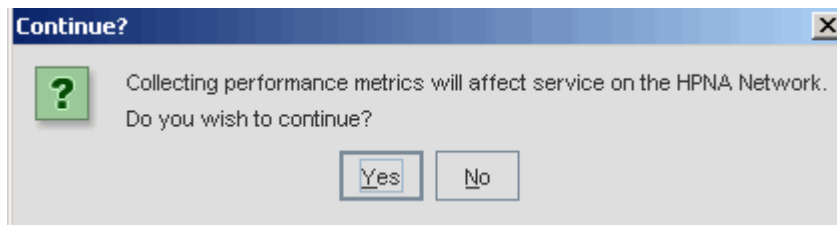

FIGURE 7-112 HPNA Testing - Confirmation Window since will affect Service

6. The user then presses the No button to cancel the operation before service is affected.

7.9.4 iBG915-FX

7.9.4.1 Overview

With the iBG915-FX, the main difference between this CPE and CPE already supported is that the iBG915-FX supports 8 VoIP lines, four more than any previous iMG/RGs. Also, the iBG915-FX supports 5 LAN ports, rather than 3, 4 or 6 LAN ports.

The NMS provides the same support as other iMG/RGs (discovery support, triple play provisioning/de-provisioning and management support, iMG/RG profile support, GenBand interworking support, backup/restore support, software download support, and “Device Info” support).

Note: CPU-based rate limiting is supported, as with the iMG MOD devices. This feature is included in the following subsections.

7.9.4.2 Changes to the GUI

- iMG/RG Voice Profile Windows

The iMG/RG Voice Profile screen is modified to allow the user to specify the configuration to be applied to lines 5 through 8. Refer to the following figures.

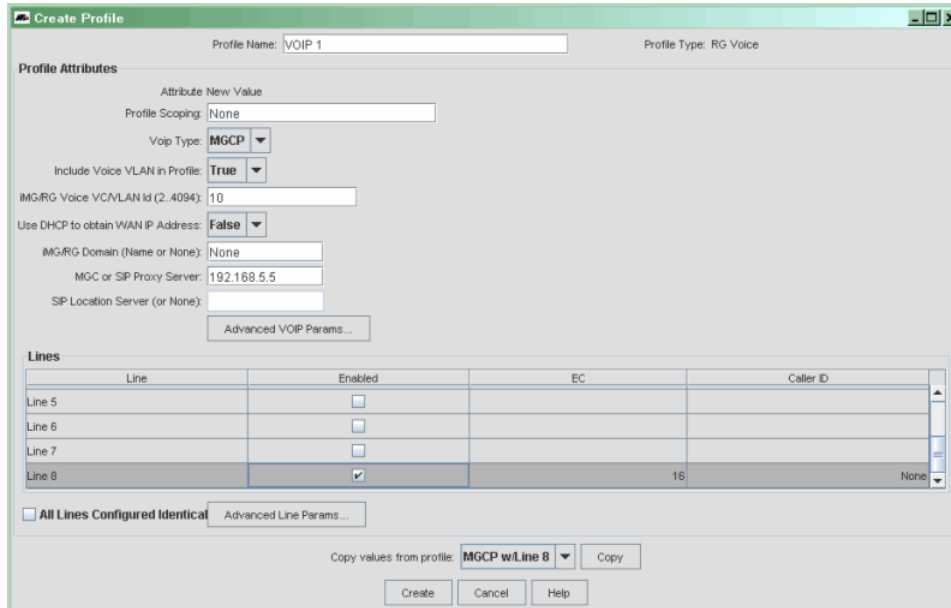

FIGURE 7-113 Voice Profile for iBG915-FX

Modify Profile Profile Name: SIPwLine8 Profile Type: RG Voice

Profile Attributes

Attribute	Current Value	New Value
Profile Scoping:	None	<input type="text"/>
Voip Type:	SIP	
Include Voice VLAN in Profile:	True	<input type="checkbox"/>
iMG/RG Voice VCN/VLAN Id (2, 4094):	10	<input type="text"/>
Use DHCP to obtain WAN IP Address:	True	<input type="checkbox"/>
iMG/RG Domain (Name or None):		<input type="text"/>
MGC or SIP Proxy Server:	10.52.192.2	<input type="text"/>
SIP Location Server (or None):	None	<input type="text"/>

Current Line Configuration

Line	Enabled	EC	Caller ID	SIP Domain
Line 3	<input type="checkbox"/>			
Line 4	<input type="checkbox"/>			
Line 5	<input type="checkbox"/>			
Line 6	<input type="checkbox"/>			

New Line Configuration

Line	Enabled	EC	Caller ID	SIP Domain
Line 5	<input type="checkbox"/>			
Line 6	<input type="checkbox"/>			
Line 7	<input type="checkbox"/>			
Line 8	<input checked="" type="checkbox"/>	16	None	

FIGURE 7-114 Modify iMG/RG Voice Profile for iBG915-FX

- iMG/RG Voice Service Tab on the Triple Play Service Management Window

The iMG/RG Voice Service Tab of the Triple Play Service Management window is updated to show the current configuration of all eight voice lines on the iBG915-FX. In addition, the user can make updates to those additional lines. Refer to the following figure.

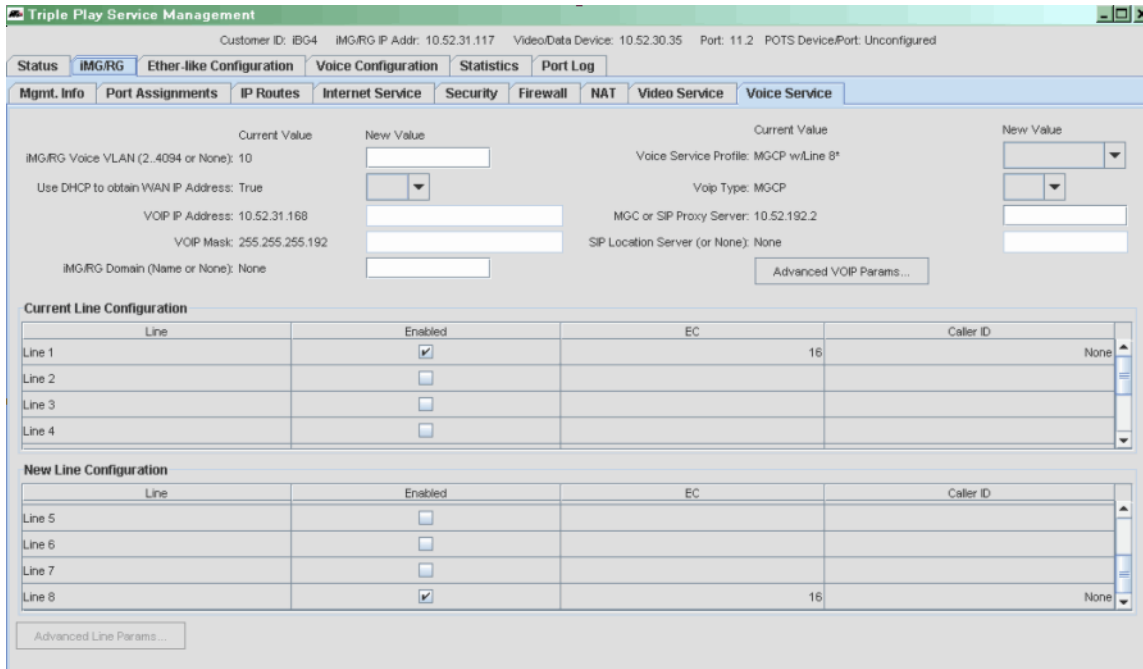

FIGURE 7-115 Service Management for iBG915-FX

- iMG/RG General Tab on the Triple Play Service Management Window

The iMG/RG General Tab of the Triple Play Service Management window is updated to **not** display the RG Loopback detection field when viewing an iBG915-FX.

- iMG/RG Internet Service Tab on the Triple Play Service Management Window

The iMG/RG Service Tab of the Triple Play Service Management window shows the Service Rate Limiting fields. (PPPoE continues not to be shown.). Refer to the following figure.

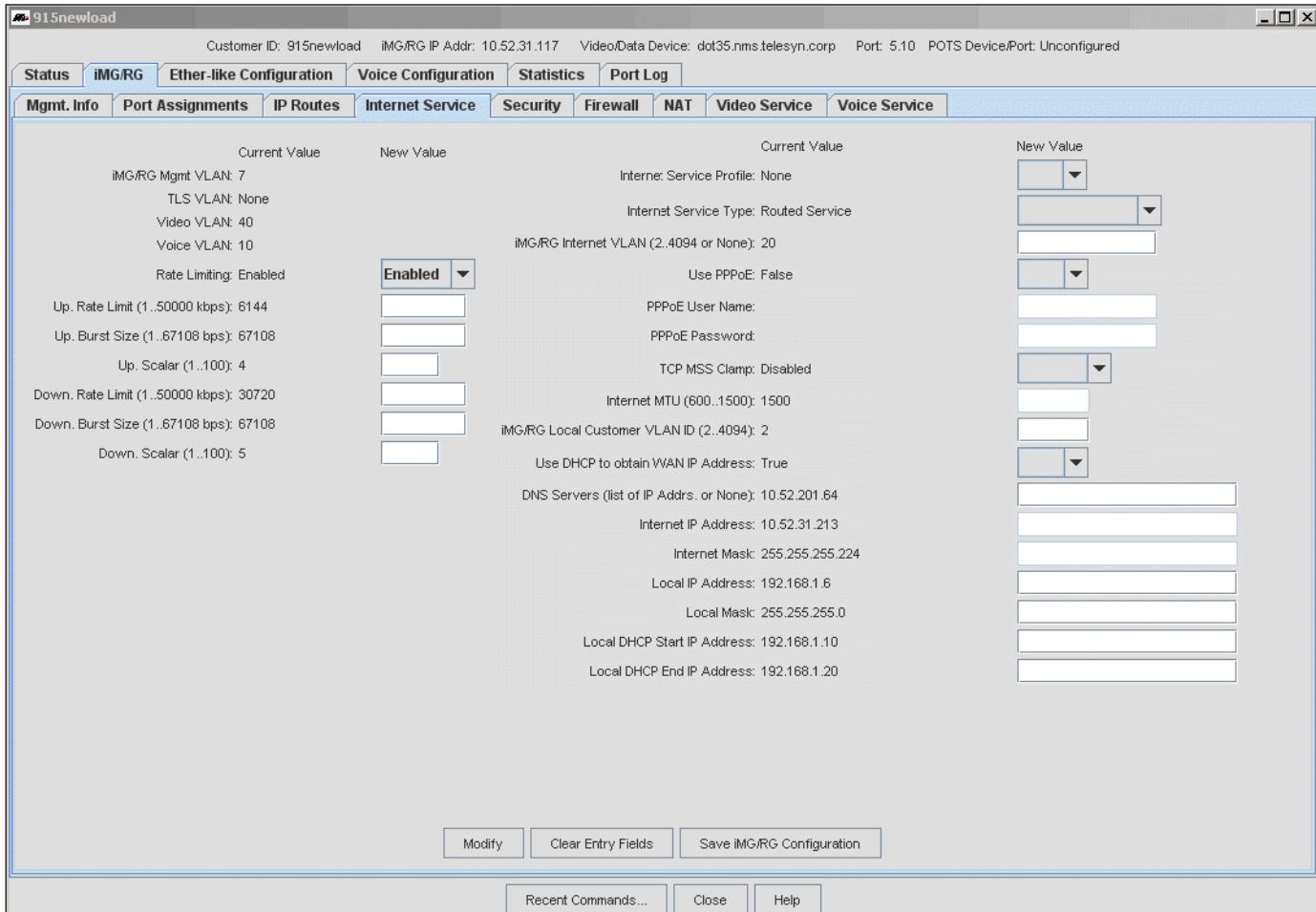

FIGURE 7-116 iBG915-FX - Internet tab includes CPU-based Rate Limiting

- iMG/RG Port Assignment Tab on the Triple Play Service Management Window

The iMG/RG Port Assignment Tab of the Triple Play Service Management window is updated to show the current configuration of the five LAN ports on the iBG915-FX. In addition, the user can make updates to those ports. Refer to the following figure.

Customer ID: iBG4 iMG/RG IP Addr: 10.52.31.117 Video/Data Device: 10.52.30.35 Port: 11.2 POTS Device/Port: Unconfigured

Management Info | **Port Assignments** | IP Routes | Internet Service | Security | Firewall | NAT | Video Service | Voice Service

Current Port Assignments

Port	Service	Speed	Upstream Rate Limit (kbps)	Downstream Rate Limit (kbps)	Admin. State	Oper. State
Port 1	Internet	Autonegotiate	None	None	Disabled	Down
Port 2	Video	Autonegotiate	None	None	Disabled	Down
Port 3	None	Autonegotiate	None	None	Disabled	Down
Port 4	None	Autonegotiate	None	None	Disabled	Down
Port 5	None	Autonegotiate	None	None	Disabled	Down

New Port Assignments

Port	Service	Speed	Upstream Rate Limit (kbps)	Downstream Rate Limit (kbps)	Admin. State	Oper. State
Port 1	Internet	Autonegotiate	None	None	Disabled	Down
Port 2	Video	Autonegotiate	None	None	Disabled	Down
Port 3	None	Autonegotiate	None	None	Disabled	Down
Port 4	None	Autonegotiate	None	None	Disabled	Down
Port 5	None	Autonegotiate	None	None	Disabled	Down

Valid Attribute Values:
Rates: "None" or 32-131040 kbps

FIGURE 7-117 iBG915-FX Port Assignments

- iMG/RG Video Tab on the Triple Play Service Management Window

Like the iMG6x6-MOD CPEs, the iBG915-FX does not support the IGMP security feature present on some of the other iMG/RGs. Because of this, the IGMP Security, IGMP Security Autolearning, and Trusted Host Limit fields, along with the Locked STD MAC Addresses table are **not** displayed on the Video Tab.

- Provision New Triple Play Customer Window

The Provision New Triple Play Customer Window is updated to allow the user to enter the configuration of up to eight voice lines (depending on the number of voice line configured in the selected iMG/RG voice profile). Refer to the following figure.

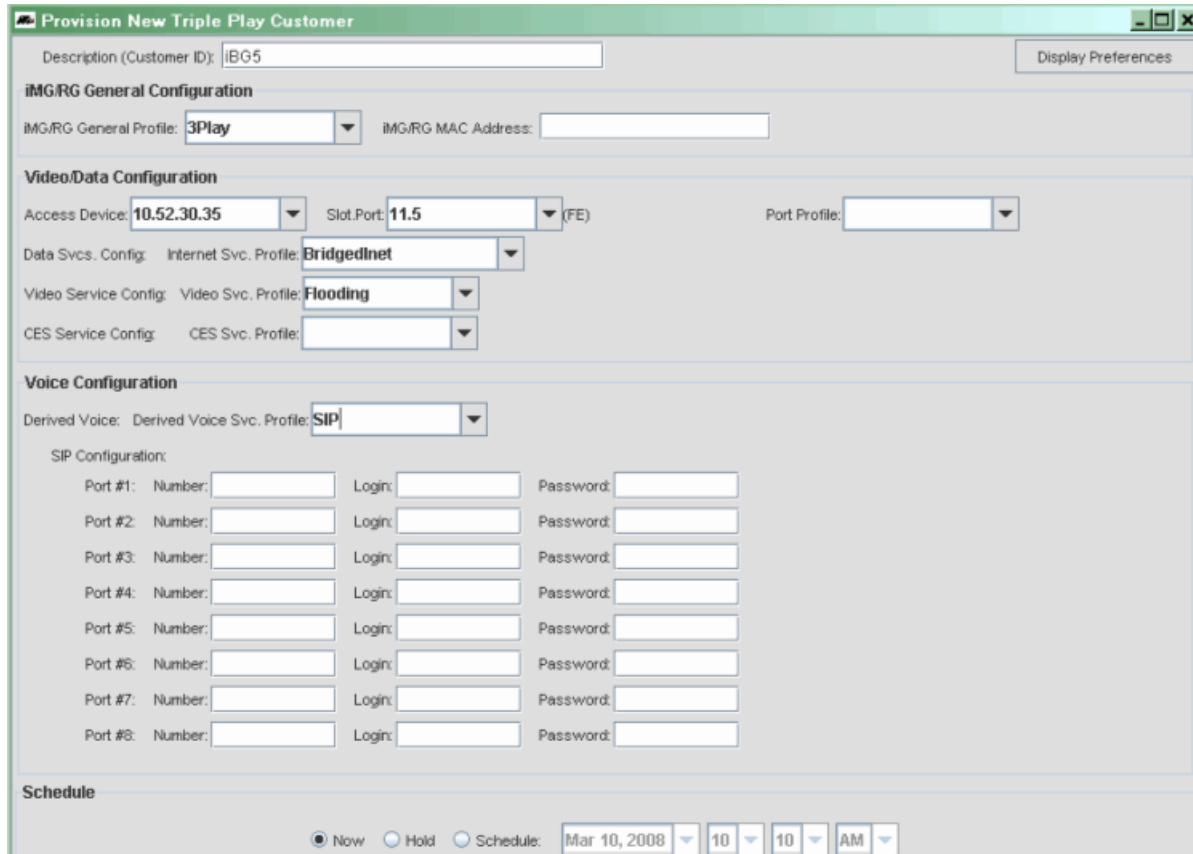

FIGURE 7-118 Provisioning New Customer for iBG915-FX

- GenBand G2/G6 - Add Voice Line Window

The window that allows that user to configure a voice line for an iBG915-FX on the GenBand G6 is modified to allow the user to specify telephone ports 5-8. Refer to the following figure.

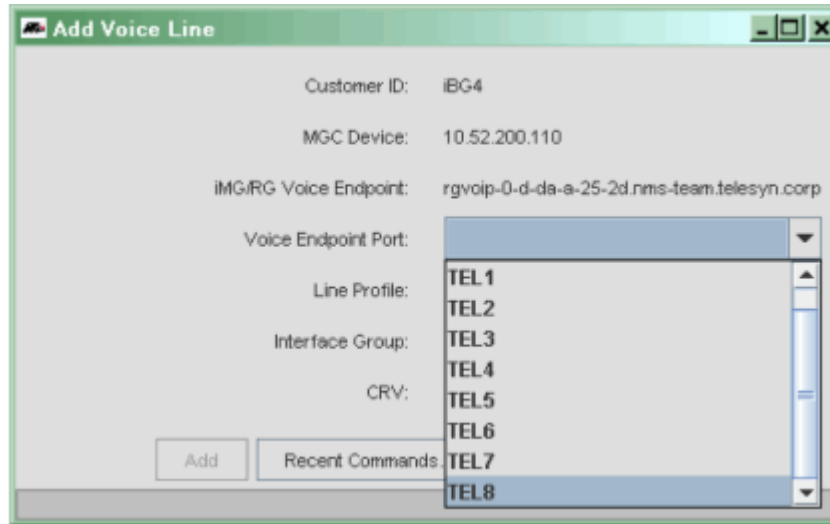

FIGURE 7-119 Adding a Voice Line to the iBG915-FX

7.9.5 iMG with WAN 1G Module

7.9.5.1 Overview

Products such as the AT-iMG7x6MOD can support the same card configuration as the AT-iMG6x6MOD, described in 7.6.8. In addition, it can support the following:

- 1 Gigabit Bidirectional WAN Module
- 1 Gigabit Bidirectional WAN Module with a Gigabit LANRJ-45 connection, allowing both the LAN and WAN ports to be configured on one module. (See notes)

Note: When provisioning using the NMS, the user will configure the LAN connection on the WAN module as G-Lan.

Note: Inserting the WAN card with the copper LAN interface disables the interface to the DS1/T1 card, and so the DS1/E1 card cannot be used.

Note: When either of the 1 Gigabit WAN cards is configured, the connection to the iMAP can only be with certain GE interfaces, as follows. Refer to 7.9.5.2.

Note: To provision the iMG/RG off the GE interface and have DHCP forwarding work, the Etherlike port Profile now includes the field Direction (either Network or Customer), in which the Direction is set to Customer. Refer to 7.9.5.2.

- Support of the HPNA 320 Module

The following figure shows a sample configuration. This is a simplified figure, since the VLAN configuration is the same as the iMG6x6MOD, as shown in Figure 7-81.

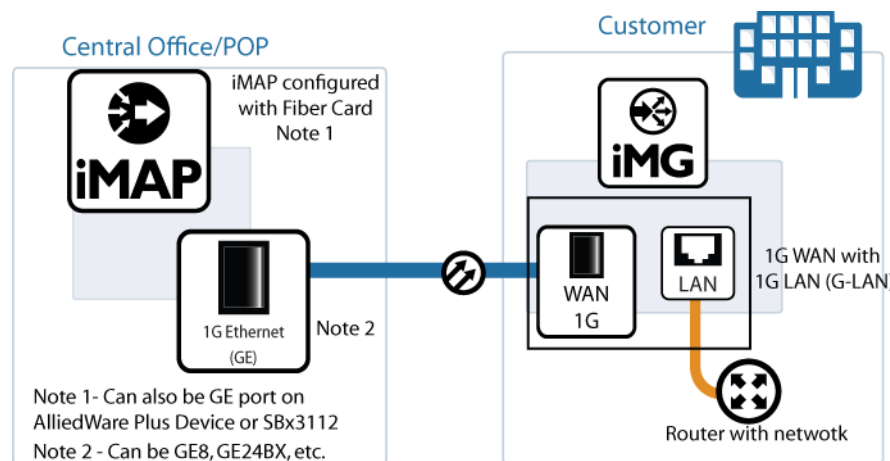

FIGURE 7-120 Example iMG7x6MOD Configuration (Simplified)

7.9.5.2 Provisioning Changes

When the iMG (such as the iMG7x6MOD or iMG726BD-ON) is configured with a 1G WAN card, the associated iMAP card must support a direction of Customer, so the GE port **must** be configured with a direction of customer (rather than network.). To allow for this, there are the following changes in provisioning:

- The provisioning of a GE port brings up the Triple-Play provisioning to allow for the configuration of an iMG/RG on that port.
- Previously, a GE port was by default set to “Network”. To provision an iMG/RG off the port and have DHCP forwarding work, the Etherlike port Profile now includes the field Direction (either Network or Customer). Moreover, the default for this field is now Customer (rather than the implicit Network).

For existing Ethernet port profiles these changes are not an issue, because they will not have the port direction field explicitly set. However, **new port profiles should be created with the port direction set to match the provisioning scenario in which they will be used**, as follows:

The following iMAP GE ports should have new profiles set with the direction of Customer when connecting with with a 1G WAN card

- GE8 on the 9x00 iMAP
- GE4 (5.0-5.3) on the iMAP 910x
- GE24BX on 9000 series iMAP
- GE24SFP on SBx3112

Caution: Modifying an existing ethernet port profile is possible but carries risks, since you will now set the port direction. Setting it to 'Customer' for an existing Ethernet port may stop service. Setting it to 'Network' on an FE/FX port with an iMG/RG (where the administrator could set the port direction to 'Customer' at the CLI) will cause the DHCP to no longer function.

Refer to the following figures.

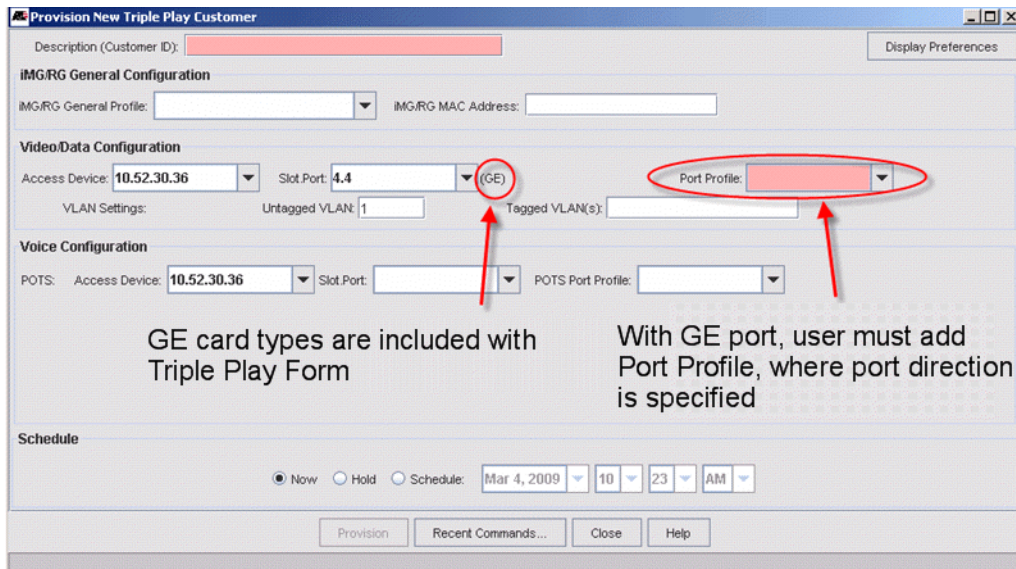

FIGURE 7-121 Provision New Triple Play Form for GE8/GE24BX/AW+/GE24SFP Port

Create Profile

Profile Name: Profile Type: Etherlike Port

Profile Attributes

Common Product Type STP POE Port Authentication

Attribute New Value

Profile Scoping:

Speed:

Duplex:

Flow Control:

Max. # of Learned MAC Adrs. (None or 0..256):

Include VLAN Configuration in Profile:

Untagged VLAN (1..4094 or None):

Tagged VLANs (comma separated list or None):

QOS Policy:

If specify VLANs in Profile, ensure they match network setup

Copy values from profile:

FIGURE 7-122 Setting the GE Port profile to Provision the VLANs

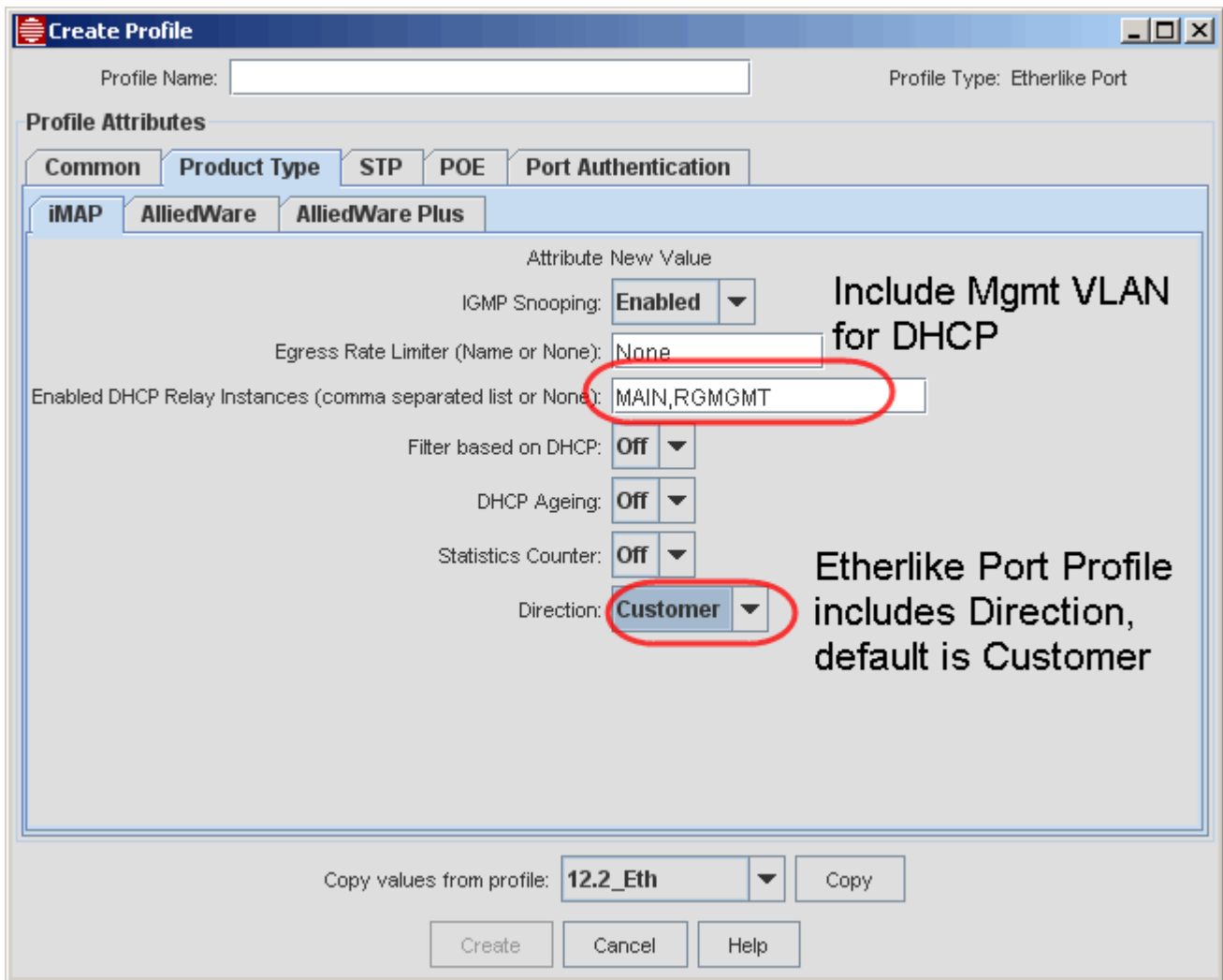

FIGURE 7-123 Setting the GE Port profile to set Port Direction

As with other profile settings, the port direction can be (re)set on the Customer Management Form, under the Ether-like Configuration tab. Refer to the following figure.

Caution: With the IMG7x6MOD, do not change the port direction once it has been set for Customer. To change the direction will mean a loss of service.

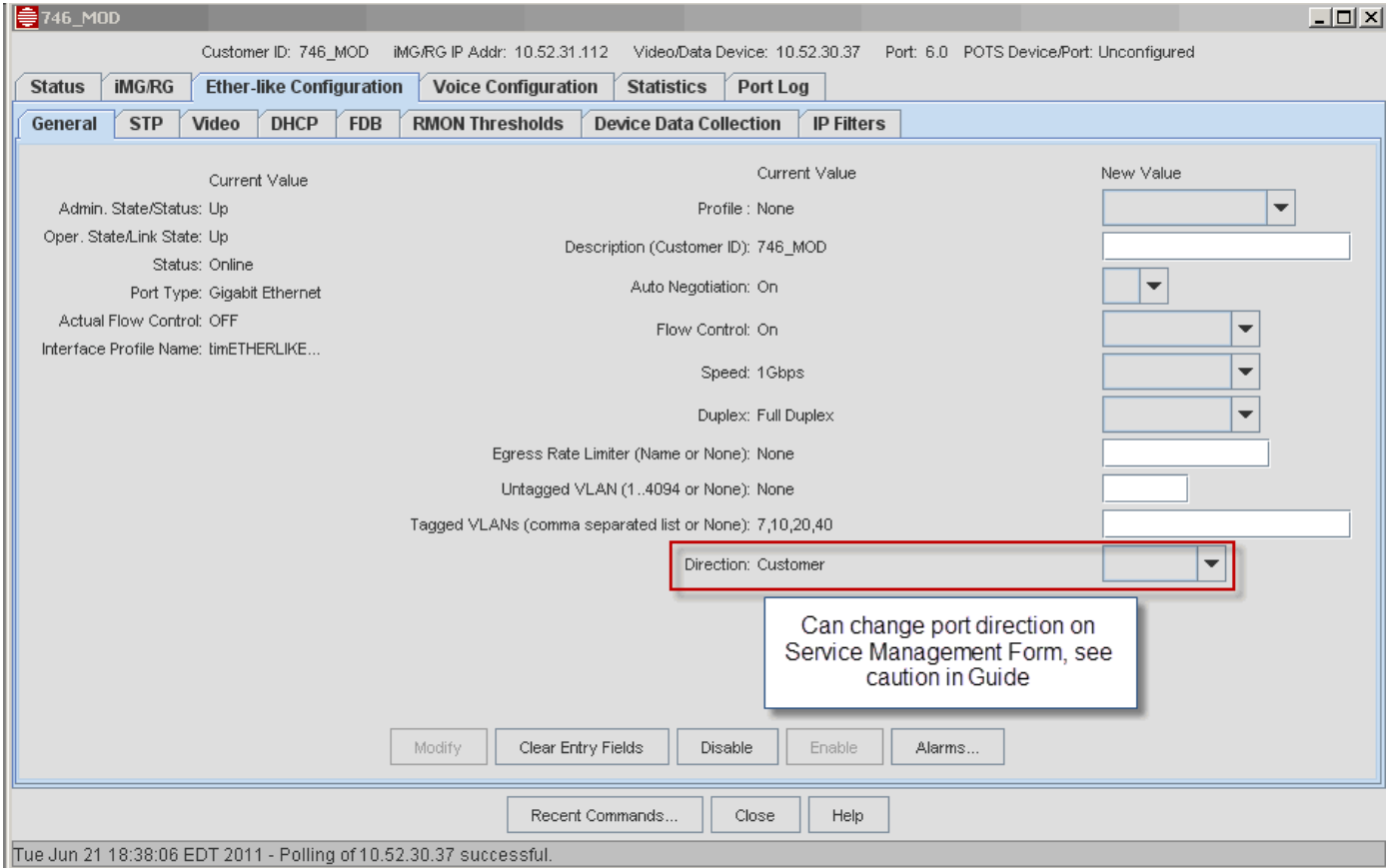

FIGURE 7-124 Customer Management, showing Port Direction

The RG General Profile is changed to include the G-Lan port (the port available when the 1 Gigabit WAN with RJ-45 LAN card is used). When this card is used, the General Profile includes the altered Port Assignments to allow the customer to provision services on the G-Lan port.

Note: For the iMG726BD-ON, there are 2 G-Lan ports. The settings for the G-Lan will apply to both ports when the profile is applied.

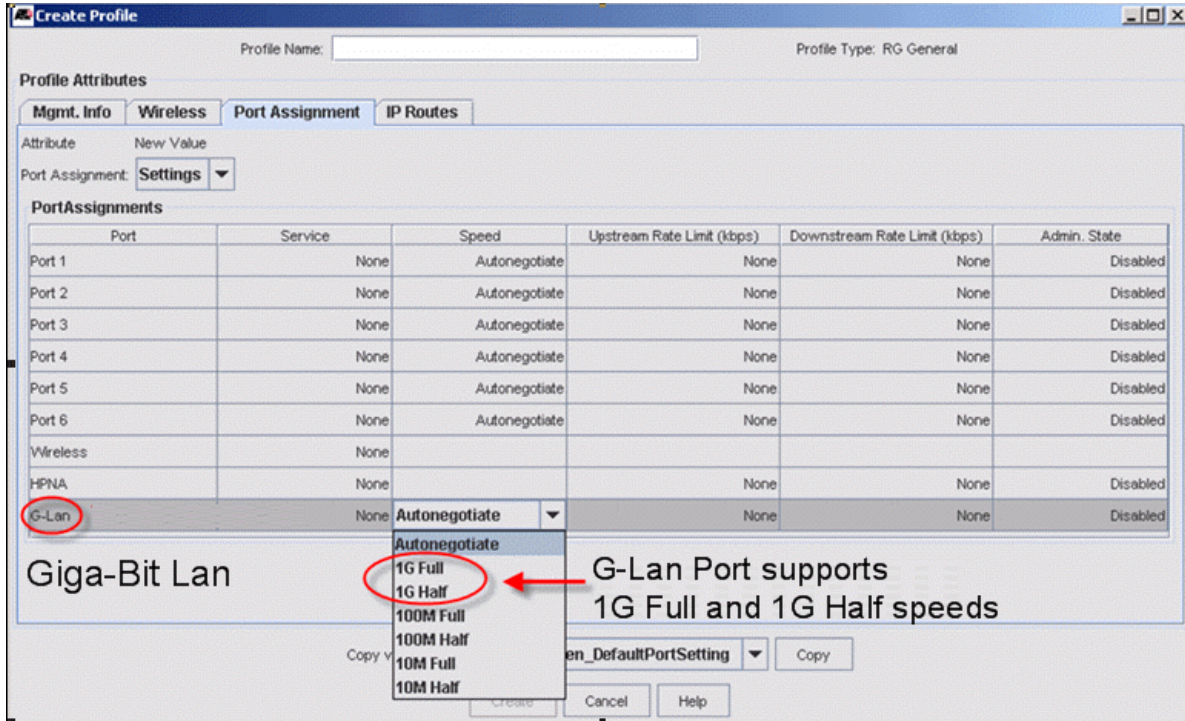

FIGURE 7-125 RG General Profile and LAN Port

7.9.6 Split Management for Wireless iMG

7.9.6.1 Overview

This feature allows a subscriber (rather than an NMS administrator) to configure wireless parameters on wireless iMG devices. This is done by accessing the web GUI that can be accessed on the device with a user ID / password.

The following devices work with this feature at iMG release 3-7_04 or above:

- iMG634WA/B
- iMG634WA/B-R2
- iMG616W

To access the wireless iMG, the subscriber will need a subscriber user ID and password; the user ID is provided, and the subscriber will change the password from the default once the feature is activated.

As shown in the example, there are provisioning rules:

- On the General Profile, on the Port Assignments tab, the wireless port must be set to “Internet” services.
- On the Internet Services Profile, the internet service type must be set to “Routed Service”
- There is Rate Limiting (upstream only) on wireless devices that are 3-8 and above. It is controlled by the Internet Services tab, Rate Limiting settings. Refer to 7.4.3.
- Part of provisioning includes the addition of management subnets the nms and split management subnets. For routed service, after the first management subnet is added (such as sub1), two subnets are created automatically, nms and split_management. If the internet service is bridged, only the nms subnet is created, and the management subnet must be added manually. For this subnet, the customer IP address (assigned by DHCP or with a static address) should be known by the NMS user.

7.9.6.2 Setting up Split Management - New CPE

The iMG/RG General Profile has the field **Split Management** and also shows the default user ID / password (admin / admin). Note that the user ID/ password are read-only. Refer to the following figure.

In the Internet Service Profile, with the internet service type set to "Routed Service", the local IP addresses are used to access the device.

In the Internet Service Profile, with the internet service type set to "Bridged service", the internet IP address is used to access the device.

Note that the mask for the management subnet should be 255.255.255.255.

After filling in the Triple Play form using the appropriate profiles, the feature is active, and the subscriber can access the device the device to change wireless parameters. Refer to 7.9.6.5.

The screenshot shows the 'Create Profile' dialog box for an 'RG General' profile. The profile name is 'iMG616W-NEW-SPLIT-ENABLE-2'. The 'Profile Attributes' section includes tabs for 'Mgmt. Info', 'Wireless', 'Port Assignment', and 'IP Routes'. Under 'Mgmt. Info', various fields are visible, including 'Profile Scoping' (None), 'Loop Detection' (Disabled), 'iMG/RG Bootstrap VLAN ID' (1), 'iMG/RG Mgmt VC/VLAN ID' (104), 'Include Service VLANs in Profile' (True), 'iMG/RG Internet VC/VLAN ID' (4000), 'iMG/RG Video VC/VLAN ID' (20), 'iMG/RG Voice VC/VLAN ID' (2000), 'iMG/RG CES VC/VLAN ID' (None), 'iMG/RG Additional VLAN IDs' (None), 'System Power Management' (Enabled), 'SNTP Server (IP Addr. or None)' (None), 'Daylight Saving' (Enabled), 'Time Zone' (EST), 'Limited User Login (login or None)' (None), 'New Limited User Password', 'New Manager Password', 'Super User Login (login or None)' (None), 'New Super User Password', 'Split Management' (Enabled), 'Subscriber User Login' (admin), and 'New Subscriber User Password' (admin). At the bottom, there is a 'Mgmt. Subnets' table with one entry: 'sub1' with Subnet Addr. '1.2.3.0', Mask '255.255.255.0', Start Addr. '1.2.3.1', and End Addr. '1.2.3.254'. Below the table are buttons for 'Copy values from profile: 12.2_Gen', 'Copy', 'Create', 'Cancel', and 'Help'.

Name	Subnet Addr.	Mask	Start Addr.	End Addr.
sub1	1.2.3.0	255.255.255.0	1.2.3.1	1.2.3.254

FIGURE 7-126 RG General Profile - Split Management

7.9.6.3 Setting up Split Management - Existing CPE

If a device is already provisioned, the feature is by default de-activated. This is shown by accessing the Service Management form for the iMG and going to the iMG/RG tab, Mgmt. Info subtab, as shown in the following figure.

The screenshot shows the Service Management form for a device with Customer ID 624AR2_11.6. The 'Mgmt. Info' tab is selected, and the 'Split Management' field is highlighted in yellow, showing it is currently set to 'Disabled'. The form includes various configuration fields for system information, network settings, and user management.

Current Value	New Value	Current Value	New Value
IMG/RG Type: iMG634-WA-R2		IMG/RG General Profile: None	<input type="text"/>
MAC Address: 00:0D:DA:0B:C2:93		SysContact (Customer ID or None): 624AR2_11.6	<input type="text"/>
System Up Time: 00:50:27		SysLocation (location or None): 10.52.30.35_11.6	<input type="text"/>
IMG/RG Mgmt VCVLAN: 7		SysName (system name or None):	<input type="text"/>
Video VCVLAN: 40		Limited User Login (login or None): None	<input type="text"/>
Internet Svc. VCVLAN: 20		New Limited User Password: N/A	<input type="text"/>
Voice VCVLAN: 10		New Manager Password: N/A	<input type="text"/>
Internet Local VLAN: 2		Super User Login (login or None): None	<input type="text"/>
TLS VCVLAN (2..4094 or None): None	<input type="text"/>	New Super User Password: N/A	<input type="text"/>
SNTP Server (IP Addr. or None): None	<input type="text"/>	Split Management: Disabled	<input type="text"/>
Daylight Saving: Disabled	<input type="text"/>	Subscriber User Login: None	<input type="text"/>
Time Zone: EST	<input type="text"/>	New Subscriber User Password: N/A	<input type="text"/>

Current Mgmt. Subnets

Name	Subnet Addr.	Mask	Start Addr.	End Addr.

FIGURE 7-127 Mgmt. Info tab for Existing Wireless Device - Disabled (Default)

To enable this feature, the administrator can do one of the following:

- On the Service Management form, change Split Management to Enabled. Click on **Modify** to activate the feature.
- Modify the iMG/RG General profile to set Split Management to Enabled and redeploy the profile to the device

Note: It is recommended to modify the iMG/RG General Profile and redeploy the Profile; otherwise you are changing an attribute that is part of the deployed profile, and so the iMG will show up as out of profile.

7.9.6.4 Viewing the Service Management Form

Once Split Management is enabled, the *iMG/RG* -> *Mgmt. Info* tab will show that Split Management is Enabled and Subscriber Login and Password. The subscriber should immediately change the password (refer to 7.9.6.5). Also, the Mgmt. Subnets are listed as follows:

For Routed internet service, nms and split_management are automatically added to the list.

For Bridged internet service, only the nms subnet is added. The NMS user must add a split_management subnet. The customer IP address (assigned by DHCP or with a static address) should be known by the NMS administrator. The subscriber should know the Service Set ID (SSID) and IP address for the wireless iMG (for routed service this is the Gateway). Refer to the following figures.

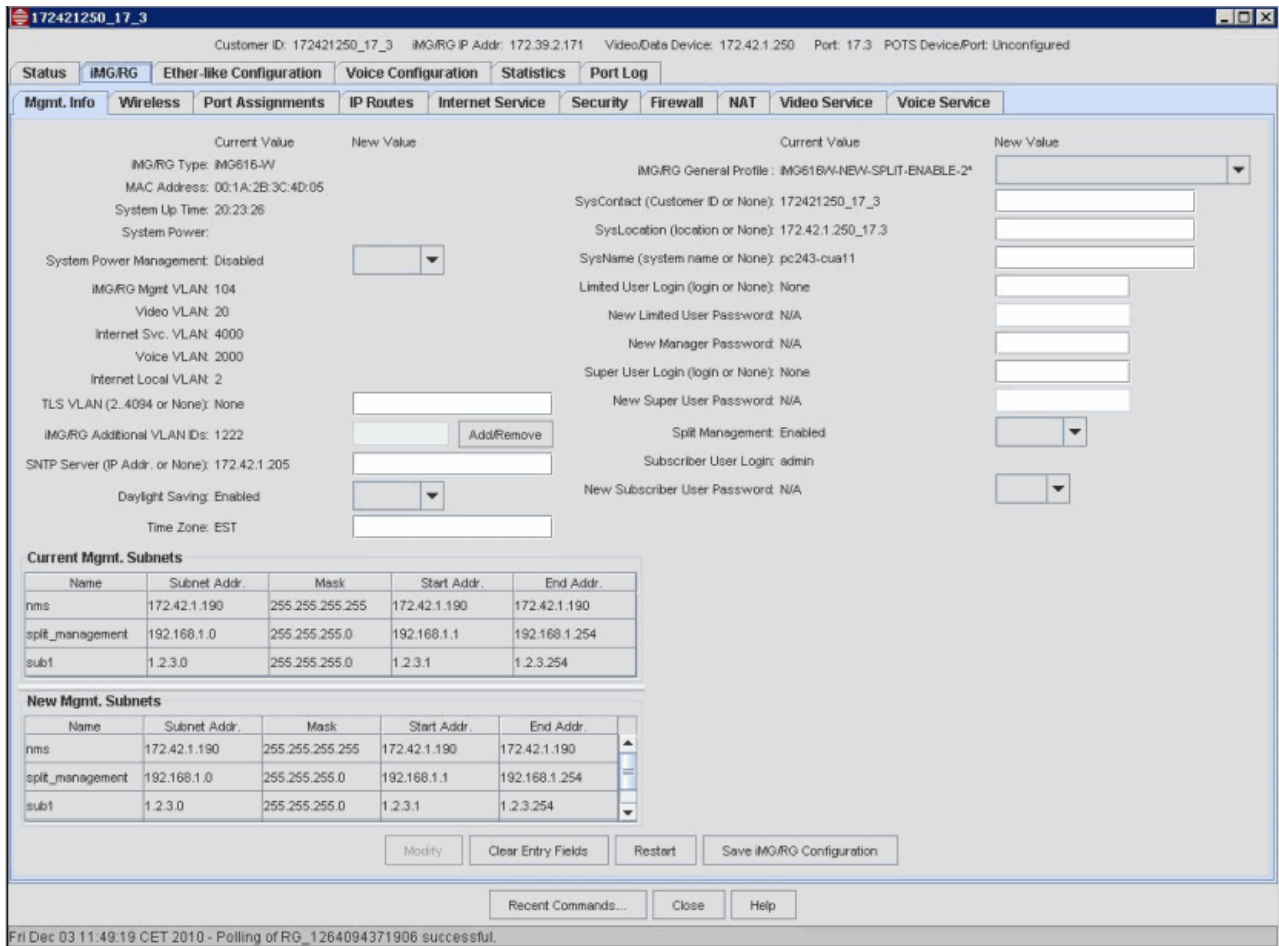

FIGURE 7-128 Service Management Form - Routed Service

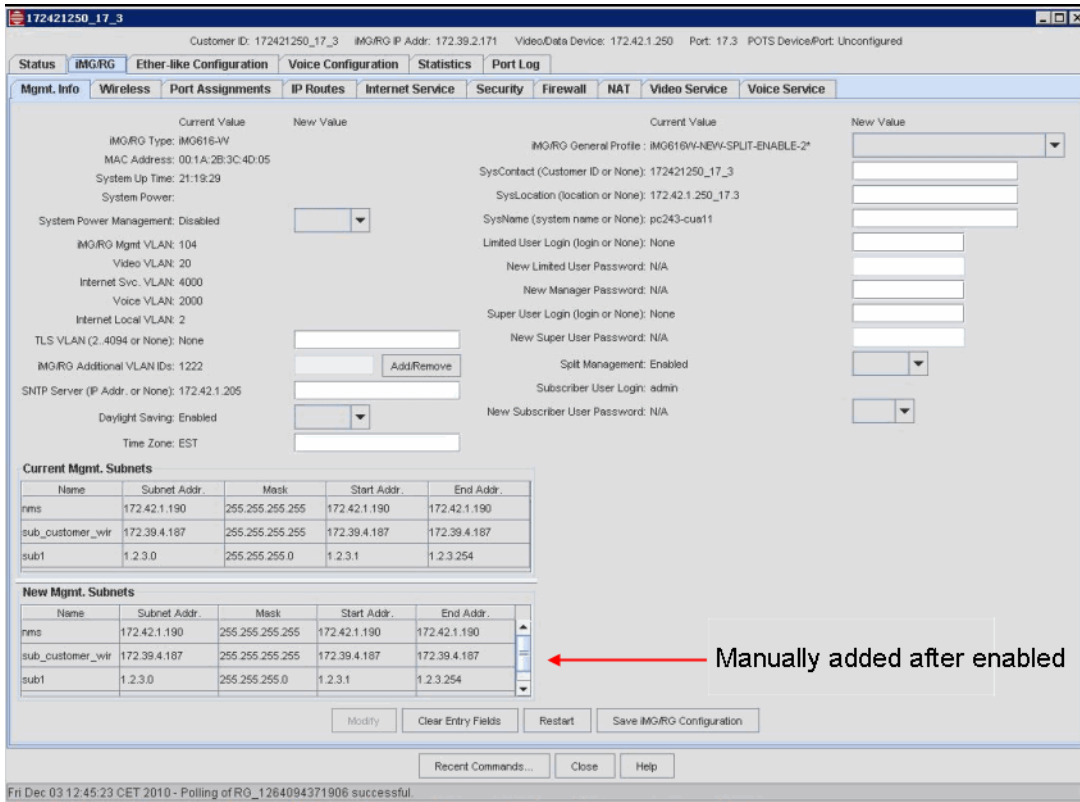

FIGURE 7-129 Service Management Form - Bridged Service

7.9.6.5 The Subscriber Using the Feature

Once the feature is activated, the subscriber can connect to the iMG over the web interface using the default id / password of admin / admin. Although the subscriber at this point can change wireless parameters, it is recommended that the subscriber first change the password for security.

Note: While the feature is activated, the NMS administrator cannot modify the wireless parameters. However, any parameters changed by the subscriber are written to the NMS database; any backups made by the NMS will therefore include the changed wireless parameters. This affects certain recovery scenarios as explained below.

The subscriber as admin with default privileges can do the following on the device:

- Change wireless configuration parameters
- **Admin > Change Password**
- **Admin > Save Configuration**
- **Security > MAC Filtering**
- **Admin > Reboot**

With the feature up and running, the subscriber may be helped in the following scenarios

- Subscriber has forgotten the password and requests to have the password reset to the default ('admin')

The NMS administrator can reset the subscriber password by using the Service Management form. On the Mgmt. Info tab, the New Subscriber User Password is set to admin, which is the only option.

It is not necessary to disable the feature to reset the password.

When this change is made, or any change is made by the subscriber, the subscriber will need to save the configuration so it can be redeployed if the iMG should reboot.

- Subscriber requests wireless parameters to be reset to default

If the subscriber has made changes to the wireless parameters, but the CPE needs to be reset to the default configuration, the NMS administrator can go to the iMG/RG -> Wireless tab, and click on Reset Wireless Parameters. This resets the wireless parameters and restarts the CPE, as shown in the warning message.

- CPE needs to be restored from the latest backup file

If there is a hardware replacement of the iMG, or there has been a maintenance recovery scenario, the iMG should be restored to the latest backup file.

7.9.7 Changing VoIP Endpoint Syntax

As described in 7.4.5, for MGCP configurations that do not use GenBand, there is the option in the RG Voice profile to enter the VoIP endpoint that will be used. On the service management form for the iMG (iMG/RG -> Voice Service) there is the option of entering the endpoint syntax by selecting the Syntax checkbox and then filling in the iMG/RG Domain using the @ for the specific settings for the voice endpoint (@\$IP, @\$MAC, @\$HOST, etc.). Refer to the following figure.

Note: The NMS supplies the "aaln/<telport number>" at the beginning of the string, and then the user continues the value with @. Therefore, values from vendors that do not follow this format are not supported, such as "\$MAC:aaln/0@\$IP". Modifying the end-point syntax is an advanced setting and should not be used unless required by the MGCP server.

Customer ID: 626MOD iMG/RG IP Addr: 10.52.31.126 Video/Data Device: 10.52.30.35 Port: 5.9 POTS D

Status **iMG/RG** Ether-like Configuration Voice Configuration Statistics Port Log

Mgmt. Info Port Assignments IP Routes Internet Service Security Firewall NAT Video Service **Voice Service** CE

Current Value	New Value	Current Value
iMG/RG Voice VLAN (2..4094 or None): 10	<input type="text"/>	Voice Service Profile: None
Use DHCP to obtain WAN IP Address: True	<input type="checkbox"/>	Voip Type: MGCP
VOIP IP Address: 10.52.31.151	<input type="text"/>	MGC or SIP Proxy Server: 10.52.192.2
VOIP Mask: 255.255.255.192	<input type="text"/>	SIP Location Server (or None): None
iMG/RG Domain (Name or None): @\$MAC	@\$MAC <input checked="" type="checkbox"/> Syntax	Advanced VOIP Pa

Current Line Configuration

Line	Enabled	EC
Line 1	<input checked="" type="checkbox"/>	
Line 2	<input type="checkbox"/>	

New Line Configuration

Line	Enabled	EC
Line 1	<input checked="" type="checkbox"/>	
Line 2	<input type="checkbox"/>	

FIGURE 7-130 Setting VoIP Endpoint Syntax

7.9.8 Provisioning Custom VLANs

Although the RG General Profile is used to define VLANs for specific services, the iMG can support up to 14 VLANs. Each port can be connected to any VLAN in any combination of tagged, untagged bridged and routed configurations.

Note: When modular devices (iMG 726, iMG746, etc.) are used, one VLAN is used to manage HPNA and CES. Therefore, when the HPNA or CES card is provisioned, there is one less VLAN available.

To allow for this, the RG General Profile can support these additional VLANs. Refer to the following figure.

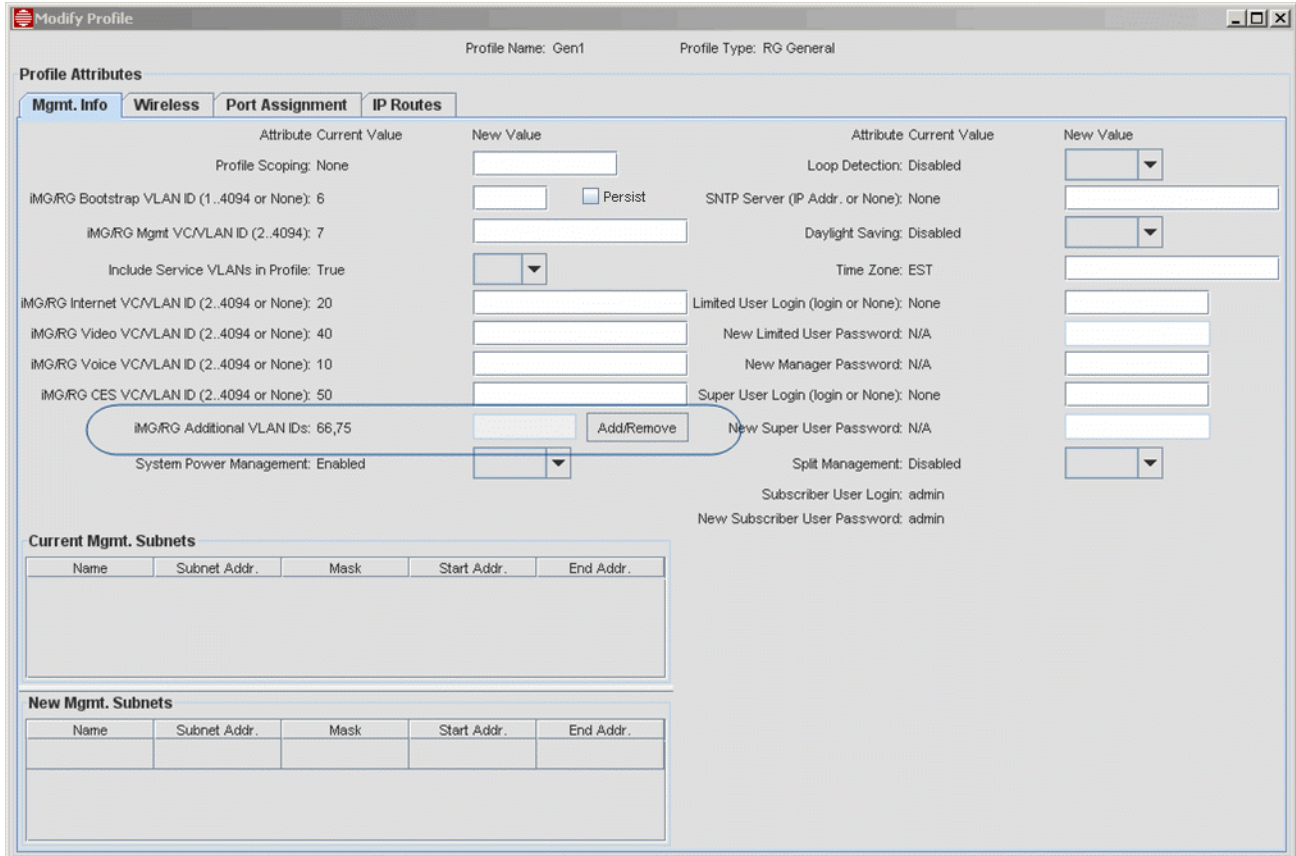

FIGURE 7-131 RG General Profile - Additional VLANs

The Add/Remove button allows the user to create or modify the additional VLANs in iMG. Refer to the following figure.

Additional Vlans

Current Vlan Table

VID	Name	WAN
66	Vlan66	
75	Vlan75	

New Vlan Table

VID	Name	WAN
66	Vlan66	
75	Vlan75	

Note: Vlans in device (including Service Vlans) cannot exceed 14

FIGURE 7-132 Panel to Add/Remove/Modify Custom VLANs (Once Profile is Created)

This panel includes the name and indication if the VLAN is tagged on WAN port. The table format used works similar to others in NMS where the top table shows current values and the bottom table is for editing. Since iMGs cannot have more than 14 VLANs, this will limit the number of VLANs in device to 14 (including Default and all service VLANs).

Also to support the custom VLANs, the Advanced parameters panel on the iMG/RG Service Management Panel (*iMG/RG->Port Assignments*) for LAN ports includes fields that allow the user to specify untagged VLAN ID or tagged VLAN IDs on the selected port. These VLANs specified must be those that were created as additional VLANs (not service VLANs) and are only allowed if the LAN port is not associated to any other service (set to None). This is done to protect existing services from being affected by configuration or traffic that may be sent through additional VLANs. Refer to the following figure.

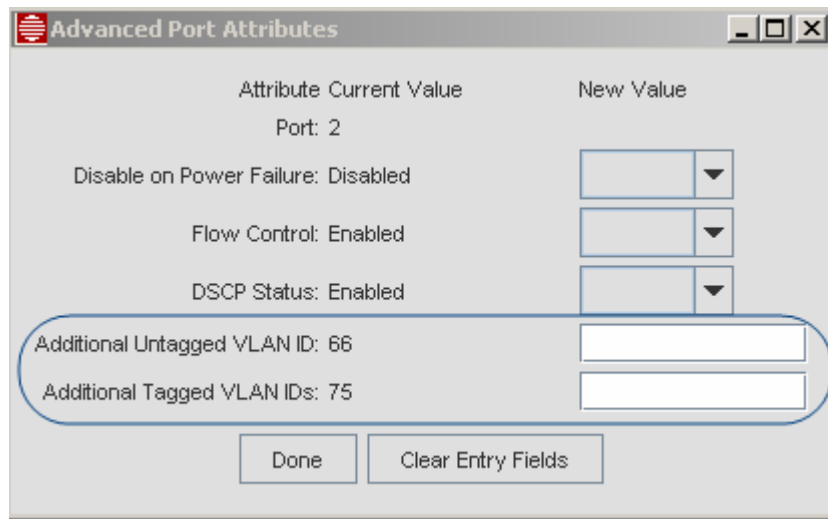

FIGURE 7-133 Advanced Port Attributes - Custom VLANs

7.9.9 Error Conditions when Provisioning

7.9.9.1 Access Island and Open Access

Since provisioning each model involves a different VLAN configuration, the following steps will produce an error message:

- In both the RG General Profile and Service Profiles no service VLANs are datafilled
- There is conflict between the VLAN configuration in the iMG/RG General Profile and in the Service Profiles
- The Profiles and provisioned VLANs don't match, and so the iMG/RG in the Inventory table will have a * under the appropriate Profile

7.10 Installation Procedures

7.10.1 Overview

With the use of the AlliedView NMS profiles and DHCP, the installation, reconfiguration, and de-installation of iMGs/RGs does not involve complex (and therefore error-prone) procedures. These procedures can be grouped into two main areas:

1. Installing, reconfiguring, and removing the iMG/RG using AlliedView NMS
2. Changing an iMG/RG that was not configured using the AlliedView NMS to one that does

In the first area, the initial installation of an iMG/RG (out of the box) includes most of the steps that are needed when reconfiguring or removing the iMG/RG, in a different sequence.

A special procedure is the changing of the Customer ID, since certain steps must be followed to ensure the ID has been changed. Refer to 7.10.10.

Note: The procedures here will assume that the user is performing these procedures for the Access Island. Whenever there is a change in a step needed to accommodate the open Access model, this change will be highlighted.

*Note: In release 10.0, NMS supports translations on the iMAP ports. For all of the following procedures, if the procedure includes adding a translation (or translations) to the iMG/RG configuration, the iMAP port profile that includes the translation must be applied **before** changes are made to the iMG/RG profiles.*

7.10.2 Installation Restrictions

7.10.2.1 Initial and Subsequent “push down” of Configuration Data

When provisioning the RG from the AlliedView NMS, there is the initial sequence of:

1. Pre-provisioning (ports, profiles)
2. Discovery (DHCP)
3. the “pushing down” of the initial configuration data.

It is important to note that once this data is pushed down, subsequent discoveries of the RG by the AlliedView NMS (usually every 24 hours) do not include a subsequent pushing down of this data if there has been a change in the iMG/RG configuration since the last discovery. If changes have been made to the iMG/RG configuration (such as a change in profile), the AlliedView NMS will make only the changes to the iMG/RG necessary to reflect the new configuration.

Note: This is in contrast to other methods (ZTC) where the configuration server stored the iMG/RG configuration. The iMG/RG would query the ZTC if there had been a change made on the ZTC server; if there had been a change, the ZTC would reconfigure the iMG/RG and upon reboot the changes would take effect.

Moreover, the behavior of the AlliedView NMS is that if the pushing down of **initial** configuration data fails (perhaps due to a network fault), the AlliedView NMS raises an alarm. The user can then:

- Wait 24 hours for the next discovery (or more if there are many devices)
- Perform a manual discovery

In either scenario, the AlliedView NMS will try to push down the configuration data.

The important concept is that **the AlliedView NMS does not try to push down the configuration data unless this is for new hardware**. This leads to the next subsection.

7.10.2.2 Moving the iMG/RG to another Port (Re-provisioning)

As explained in 7.1, an administratively efficient way to provision the iMG/RG is by using Access Islands, with each Access Island having its own unique set of VLANs. This makes moving an iMG/RG from one port to another behave as follows:

- If the user moves an already provisioned iMG/RG from one iMAP port to another in the **same** Access Island, the Allied-View will treat the iMG/RG as new hardware and will de provision and re-provision the RG, using data for that new port.
- If the user moves the already provisioned iMG/RG from one iMAP port to another in a **different** Access Island, the Allied-View NMS won't see the RG because it is not the correct RGMgmt VLAN (and IP address) for that Access Island. In this scenario, the user should telnet to the iMG/RG before removing the iMG/RG and set the iMG/RG back to its factory settings. Then, when moving the iMG/RG to the new port in the different Access Island, DHCP discovery will start with the RG's default VLAN and go through the process of finding and then using the RGMgmt VLAN for that new Access Island.

7.10.3 Pre-provision Future Customer (Provision iMAP Port, no Services)

7.10.3.1 When to use this Procedure

- The administrator wishes to provision the iMAP port with the iMG/RG, and not provision any specific services. (An example would be for a vacant residence.)
- Services will be added later.

7.10.3.2 Pre-requisite Procedures

Before performing this procedure, the administrator should have already done the following:

- Have an iMG/RG General Profile with a name such as "DVLK-AI01-Vacant" and include scoping so that when it is used only iMAPs from AI01 are accessible. Refer to Figure 7-134, Figure 7-135, and Figure 7-136.

Note: For Open Access, the Profile Name could be "DVLK-Vacant" since the Access Island number is not used as part of Scoping.

- Have a port profile available that reflects the type of port and the capabilities desired, such as "DVLK-AI01-100Mbps".

Note: In this profile, the VLAN Configuration is not included.

- Have a customer ID ready that reflects administrative naming conventions for this type of provisioning. An appropriate ID would be the residence address.

7.10.3.3 Pre-provision the Customer

Using the sample names listed above, the following steps are performed:

1. Bring up the Provision New Triple Play Customer Form using one of these methods:
 - From the main AlliedView NMS menu, select **Tools -> Customer Management -> Add New Triple Play Customer**.
 - For an iMAP icon, select **Provision -> Port Management**. From the Port Management Form select the port for the work order, which will have no Customer ID, and click **Provision New Customer/Port**. (An already provisioned port should always have a Customer ID.)
 - From the port table in Network Inventory, right-click the port from the work order and select **Provision New Customer/Port**.
2. In the Provision New Triple Play Customer Form, enter a Customer ID, in this example the residence address.
3. Click on **Add Customer Info** to add the additional text.
4. Select the iMG/RG General Profile, in this case "DVLK-AI01-Vacant". Because of scoping, only those devices from Access Island 1 are available.
5. Enter a port Profile. Only those port profiles relevant for the type of port selected are available.
6. Review the filled out form, as shown in Figure 7-137.

Create Profile
Profile Name:
Profile Type: RG General

Profile Attributes

Mgmt. Info
Wireless
Port Assignment
IP Routes

Attribute New Value

Profile Scoping:

iMG/RG Bootstrap VLAN Id (1..4094 or None): Persist

iMG/RG Mgmt VC/VLAN Id (2..4094):

Include Service VLANs in Profile:

iMG/RG Internet VC/VLAN Id (2..4094 or None):

iMG/RG Video VC/VLAN Id (2..4094 or None):

iMG/RG Voice VC/VLAN Id (2..4094 or None):

iMG/RG CES VC/VLAN Id (2..4094 or None):

System Power Management:

Attribute New Value

Loop Detection:

SNTP Server (IP Addr. or None):

Daylight Saving:

Time Zone:

Limited User Login (login or None):

New Limited User Password:

New Manager Password:

Super User Login (login or None):

New Super User Password:

Split Management:

Subscriber User Login: admin

New Subscriber User Password: admin

Mgmt. Subnets

Name	Subnet Addr.	Mask	Start Addr.	End Addr.

Copy values from profile:

FIGURE 7-134 Profile for DVLK-AI01-Vacant - Mgmt Info

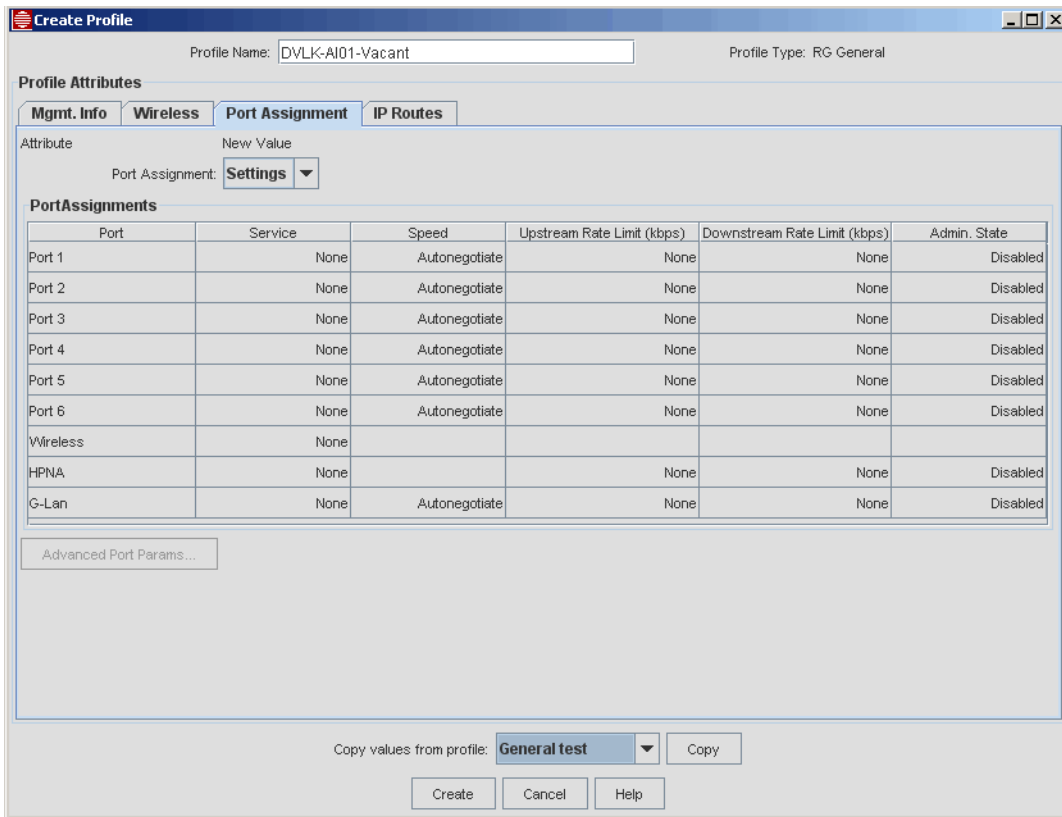

FIGURE 7-135 Profile for DVLK-AI01-Vacant - Port Assignment

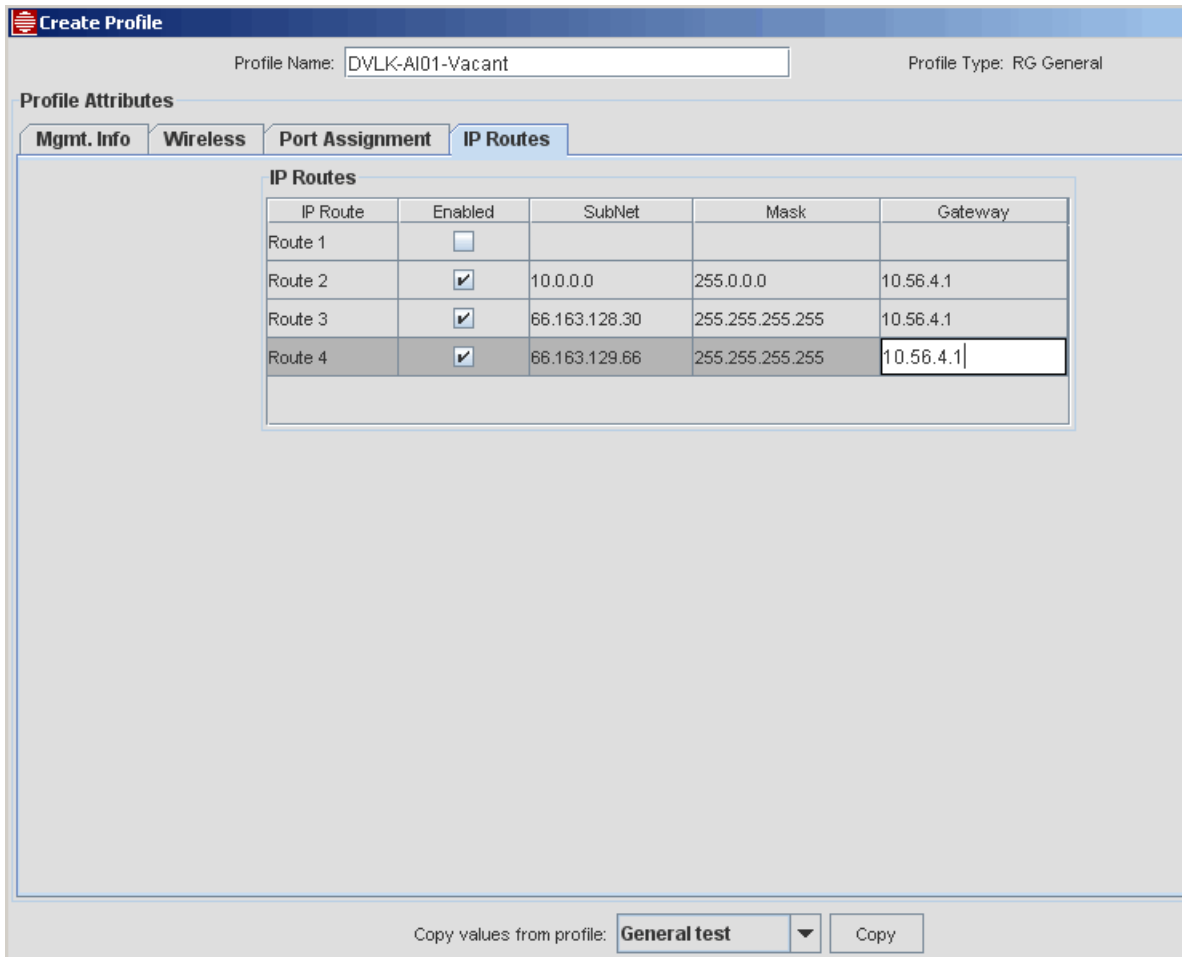

FIGURE 7-136 Profile for DVLK-AI01-Vacant - IP Routes

FIGURE 7-137 Provision Triple Play - No Services

7.10.3.4 Add Services to an Already Provisioned Port

When services must be added to the pre-provisioned port, the same steps are used when adding services to a port that already has some service(s) configured, using the View/Modify Customer window. Following is a summary of these steps. For details, refer to the procedures in the rest of this Subsection.

1. Select the appropriate new **general** profile that reflects the services desired and then **Modify**.
2. Select the appropriate **internet** profile then **Modify**. (if services required)
3. Select the appropriate **video** profile and **Modify**. (if services required)
4. Select the appropriate **voice** profile and **Modify**.
5. From the view/modify status tab **Add a derived voice line**
6. Select **Save the Config** and **Restart**.

7.10.4 Provision a new Customer (out of the box) - Triple Play

7.10.4.1 When to use this Procedure

- The iMAP port that interfaces the iMG/RG has not been created.
- Customer has purchased video, data, and derived voice service.
- The customer/installer will remove an iMG/RG from its packaging and so all settings are at factory defaults.

7.10.4.2 Pre-requisite Procedures

Before performing this procedure, the user should have already done the following:

1. At the iMAP, ensure the following are already configured:
 - VLANs for DHCP and services have been created.
 - The iMAP card/port that interfaces the iMG/RG has been installed and enabled.
2. User has work order that should include the following:
 - Attributes that will be used for GenBand configuration
3. All appropriate profiles are defined. The following profiles are used:

Note: For Open Access, the General Profile would not have service VLANs defined, while the service-specific Profiles would have VLANs.

TABLE 7-31 Example Profiles for Initial Configuration

Profile Type	Example Profile Name	Description
Upstream Port Profile	""	Used for Fast Ethernet Ports
RG General Profile	"DeskLab-3Play-1Video"	Example profile that has all three services and supports only one STB.
RG Internet Profile	"HomeNetworkInet"	
RG Video Profile	"Video-Proxy"	For video proxy service
RG Derived Voice Profile	"VOIPPhone"	For derived voice profile
Line Profile	g711_mulaw_10	Used in conjunction with G6

7.10.4.3 Provision the iMAP Port (Triple Play Form)

Datafilling the Triple Play form allows the user to create a unique Customer ID and to associate this with all the relevant profiles. Follow these steps:

1. Bring up the Provision New Triple Play Customer Form using one of these methods:
 - From the main AlliedView NMS menu, select **Tools -> Customer Management -> Add New Triple Play Customer**.
 - For an iMAP icon, select **Provision -> Port Management**. From the Port Management Form select the port for the work order, which will have no Customer ID, and click **Provision New Customer/Port**. (An already provisioned port should always have a Customer ID.)
 - From the port table in Network Inventory, right-click the port from the work order and select **Provision New Customer/Port**.
2. In the Provision New Triple Play Customer Form, enter a Customer ID
3. Click on Add Customer Info to add the additional text to define this customer.
Refer to 7.2.7 for suggestions on naming conventions for Customer ID and Customer Info.
4. Enter the iMG/RG General Profile **DeskLab-3Play-1Video** from the pull-down.
5. If necessary, enter the Access Device and Slot.Port. See the note below on scoping.

Note: With scoping, if the Triple-Play Form is brought up without an Access Device and Slot.port, only those devices that use the General Profile are available. Conversely, the user could choose a device first, and only those profiles available for that device are shown.

6. Enter a port Profile. Only those port profiles relevant for the type of port are available.
7. Select an Internet Svc. Profile, in this case **HomeNetworkInet**.
Note that the Local IP Addr, Mask, and DHCP Start/End addresses are datafilled.
8. Select an Video Svc. Profile, in this case **Video-Proxy**.
Note that the Local IP Addr, Mask, and DHCP Start/End addresses are datafilled.
9. Select a Derived Voice Svc. Profile, in this case **VOIPPhone**.
Note that the GenBand Configuration fields are now available.
10. Enter the GenBand Configuration attributes for Port #1, the Line Profile, the Interface Group, and CRV.
These values should be taken from the work order.
11. Review the filled out form, as shown in Figure 7-138.

FIGURE 7-138 Completed Triple Play Form - With Services

12. Invoke the Triple-Play form to provision the port.
 - To provision now, click on Provision. The Task Details screen appears and shows progress states. If there is a failure, double-click on the relevant sub-task for details.

- To provision, select Hold and then Provision.
- To provision at set time, click on Schedule, enter the date/time, and then Provision

Note: At this point, the user can provision other ports, since the iMG/RG has not been connected to the iMAP; all that is being provisioned is the iMAP port.

13. Review the Triple Play Service Management Form, as shown in Figure 7-139.

FIGURE 7-139 Service Management Form - iMAP Port Configured, no iMG/RG Configured

Note the following:

- The Video/Data Port Configuration Panel includes the upstream port and card/port status
- The Voice Configuration Panel includes the Voice Endpoint (needed for DNS lookup for DHCP) and the Voice Endpoint Port (TEL1, which is the port the customer will plug the phone into).
- The Alerts Panel has any alarms. There should be no alarms.

14. Review the iMG/RG table, as shown in Figure 7-140.

Custo...	IP Address	Type	Release	Upstream Port	Name	Gen Prof.	Inet Prof.	Video Prof.	Voice Prof.	CES Prof.
	10.52.31.103	IMG616-VV	3.8.0-90	10.52.30.35_5.11	R...					
	10.52.31.126	IMG626-MOD	3.8.0-90	10.52.30.35_5.9	R...					
	10.52.31.108	RG600Family		10.52.30.35_5.2	R...					
616BD	10.52.31.101	IMG616-BD	3.8.0-90	10.52.30.37_13.9	R...	timGENERAL	timINTERNET	timVIDEO		
634VA	10.52.31.95	IMG634-VVA	3.7.4-30	10.52.30.34_10.1	R...					
646_55	10.52.31.121	IMG646-BD	3.8.0-90	10.52.30.35_5.5	R...	timGENERAL	timINTERNET	timVIDEO		
Cust20	0.0.0.0	RG600Family		192.168.42.39_10.2	R...					

FIGURE 7-140 iMG/RG Table - iMAP Port Configured, no iMG/RG Configured

Note the following:

- The Customer ID, Type (Family level), and Upstream Port are identified.
- The iMG/RG IP address, software release, and associated profiles are not included. These are filled in as a result of plugging in the iMG/RG by the customer, which begins the DHCP configuration steps.

15. End of this part of the Procedure

7.10.4.4 Install the iMG/RG and Apply Power

Note: Installation instructions are included with the iMG/RG packaging, and these should be read before continuing with this part of the Procedure, since these instructions will include detailed pictures, a listing of cables that are used for the interface connections, and any updates to product information.

Note: If a technician is installing the Ethernet version of the iMG/RG, a PC (laptop) can be connected directly to monitor the progress of the iMG/RG configuration (mainly the successful allocation of addresses by DHCP). The console cable is sold separately by ATI. Use n-8-1-38400 for the console port setting.

For this part of the procedure, do the following:

1. Ensure the connection to the customer from the iMAP connection is active.
2. Remove the iMG/RG from its packaging.
3. Connect the WAN cable to the external interface port.
4. Apply power to the iMG/RG (usually by connecting the power cable to iMG/RG and then plugging it in).
5. Note the sequence of events that shows the iMG/RG as run through its initial and reboot sequence (for details refer to 7.2.6.5).

7.10.4.5 Connect Devices and wait for Services to Begin

1. Note which ports are being used:
 - LAN1 to a STB for video service
 - LAN2 to a PC for internet service
 - LAN3 - Unused
 - TEL1 - to a telephone for voice service
 - TEL2 - Unused
2. Connect the devices to the iMG/RG using the appropriate cables.
3. Once connected, devices will use DHCP and the provisioned components. When finished, all devices should be providing service. Test all devices to ensure they deliver the promised service(s).
4. END OF PROCEDURE

7.10.5 Provisioning / De-Provisioning Voice Service

7.10.5.1 Overview

When a customer has video and data service (double-play), and wishes to add voice service, the use of AlliedView NMS makes this possible, through the use of profiles, with a small number of steps. Moreover, adding or removing a second line for a service is accomplished using only a few GUI screens. Finally, removing the voice service and going (back) to double play involves (re)applying the profile for double-play.

7.10.5.2 Add Voice Service (Double-play to Triple-Play)

1. Ensure prerequisites are met:
 - Customer uses iMG/RG General Profile that enables double-play and has internet and video profiles
 - RG General - **DeskLab-1 Video-1 Data**
 - Internet - **HomeNetworkInet**
 - Video - **Video-Proxy**
 - There is an RG General Profile for Triple-Play that matches the customer attributes for double-play and adds the necessary attributes for voice (especially the voice VLAN and routes).
 - RG General - **DeskLab-3Play-1Video**
2. Find the iMG/RG for the customer in the iMG/RGs table using various methods:
 - Bring up the iMG/RGs node in the Network Inventory table and do a search (Ctrl-F) on the Customer ID.
 - Bring up the Ports node in the Network Inventory table and do a search (Ctrl-F) on the Customer ID.
3. Right click on the iMG/RG or Port and select **View/Modify Details**. This brings up the Triple Play Service Management screen.
4. Select the iMG/RG tab, which automatically shows the Mgmt. Info tab.

- In the RG General profile pull-down, select the Profile DeskLab-3Play-1 Video, as shown in Figure 7-

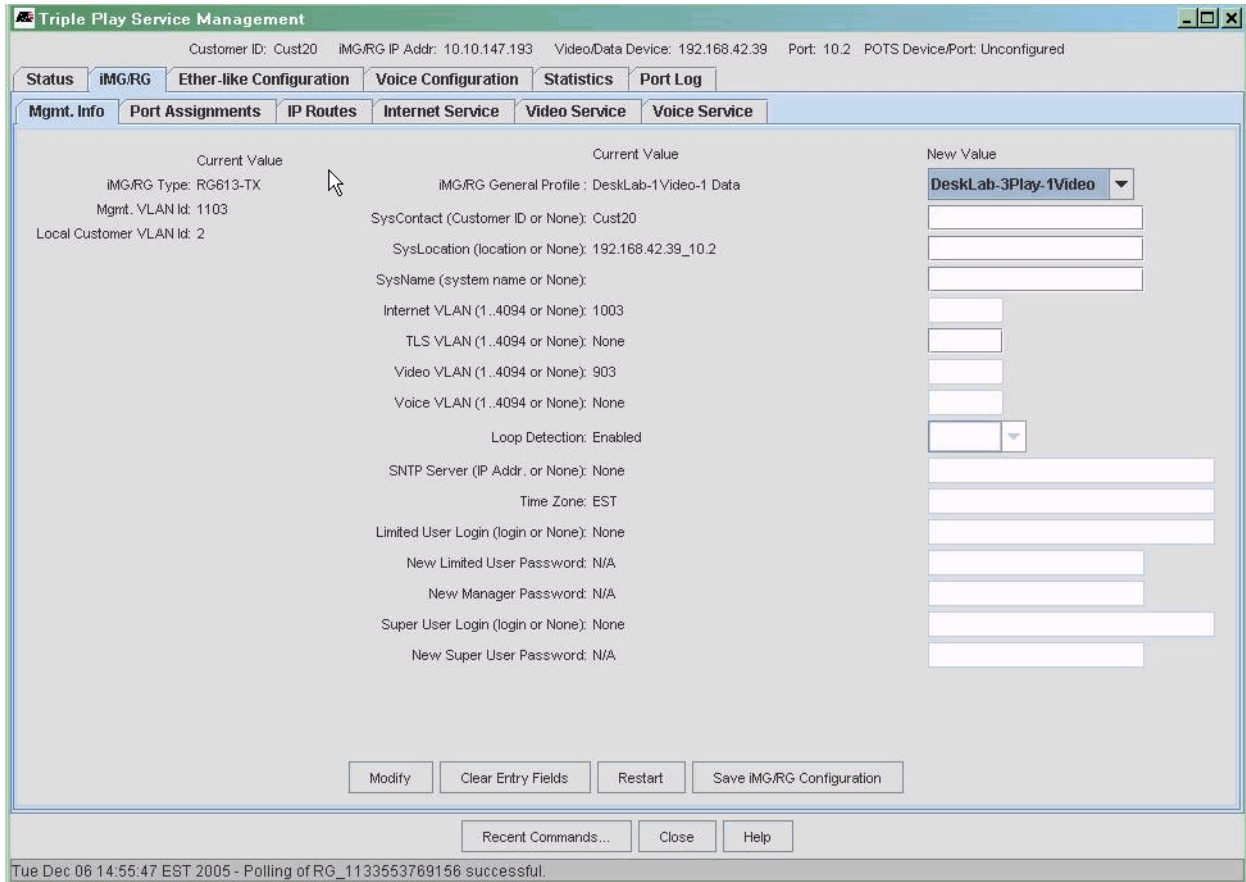

141.

FIGURE 7-141 Applying Different RG General Profile for Triple-Play

- Click on **Modify**.
- Note the results - The VLAN defined in the General Profile is added.
- Still in the Mgmt. Info tab, select the Voice Service tab
- For the Voice Service Profile pull-down, select VOIPPhone. Refer to Figure 7-142.

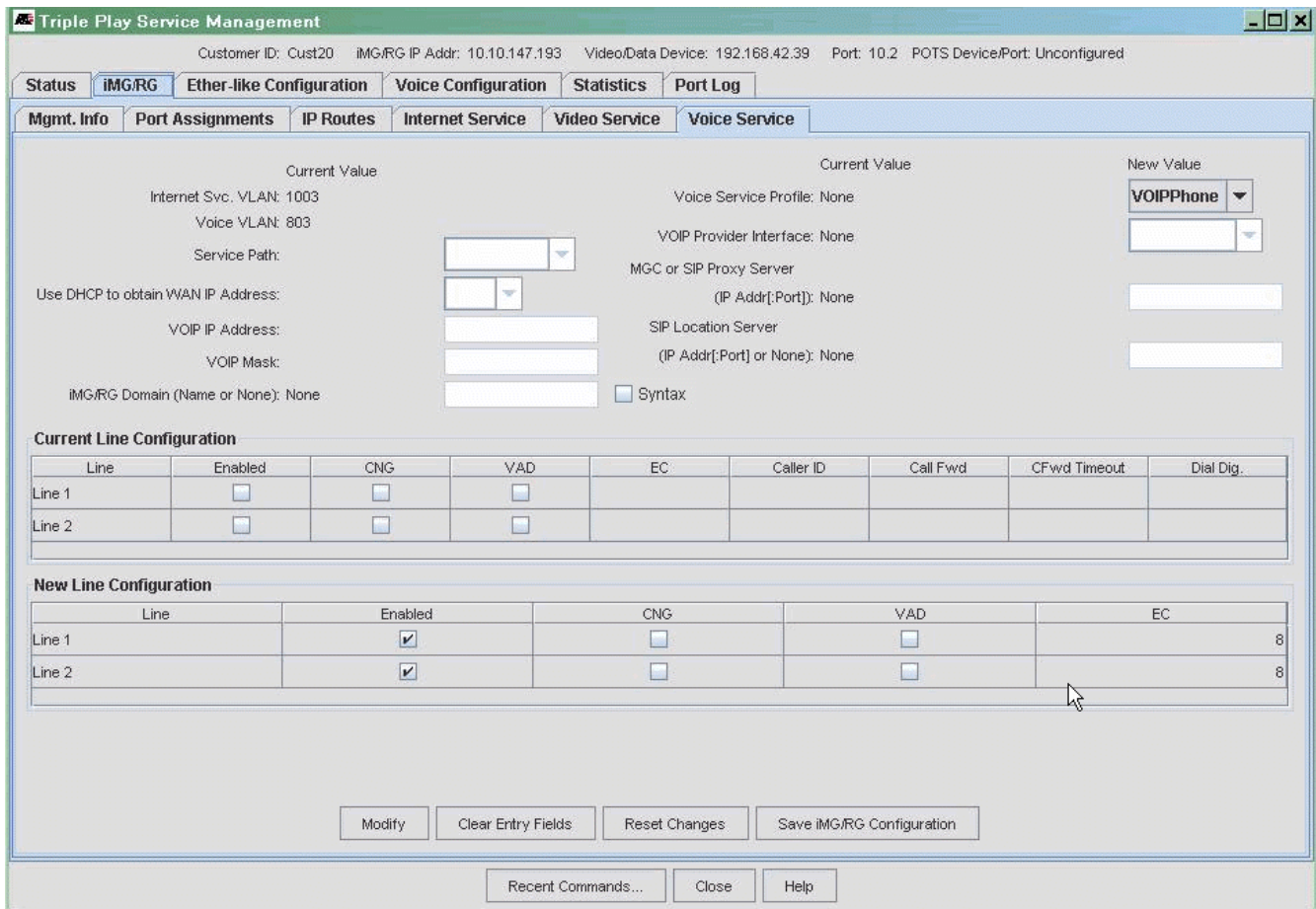

FIGURE 7-142 Applying Voice Profile

10. Click on **Modify**.
11. Select the Status tab (there are no sub-tabs).
12. Click on Add Voice Line. The **Add Voice Line** form appears.
13. In the Add Voice Line form, note that the Voice Endpoint (used for DNS) is already defined, as well as the interface group. These were defined in the Voice service profile.
14. Select from the pull-down the Voice Endpoint Port, the Line Profile, and the CRV. Refer to Figure 7-143.

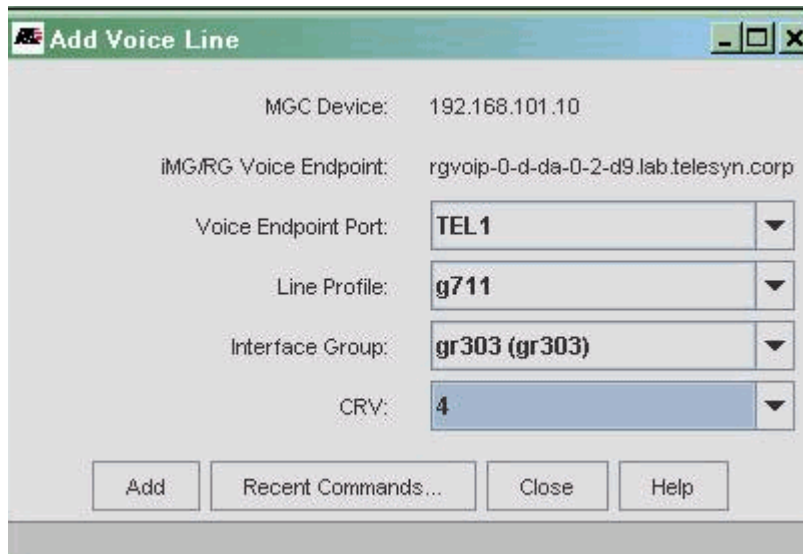

FIGURE 7-143 Add Voice Line (line 1)

15. Click on the now activated **Add**.
16. Back on the Status tab, click on Update Customer Info.
17. Note the results.
18. End of Procedure

Note: For the Open Access Model, the same procedure would be used, with the administrator ensuring that there was no conflict in VLAN configuration between the iMG/RG General Profile and the Voice Service Profile.

7.10.5.3 Add Second Voice Line

1. Ensure the prerequisites are met:
 - The Voice Profile already supports more than one voice line.
2. Find the iMG/RG for the customer in the iMG/RGs table using various methods:
 - Bring up the iMG/RGs node in the Network Inventory table and do a search (Ctrl-F) on the Customer ID.
 - Bring up the Ports node in the Network Inventory table and do a search (Ctrl-F) on the Customer ID.
3. Right click on the iMG/RG or Port and select **View/Modify Details**. This brings up the Triple Play Service Management screen.
4. The Select tab should appear by default.
5. Click on **Add Voice Line**. The **Add Voice Line** form appears.
6. In the Add Voice Line form, note that the Voice Endpoint (used for DNS) is already defined, as well as the interface group. These were defined in the Voice service profile.
7. Select from the pull-down the Voice Endpoint Port, the Line Profile, and the CRV. Refer to Figure 7-144.

Note: Since this is a second voice line, choose TEL2 for the Voice Endpoint Port; otherwise any new values chosen here will change the already existing voice endpoint.

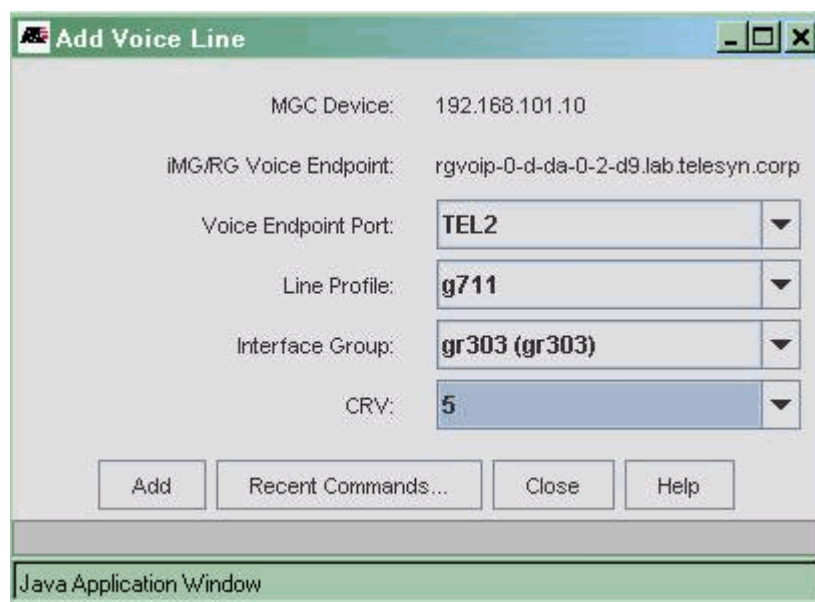

FIGURE 7-144 Add Voice Line (line 2)

8. Click on the now activated **Add**.
9. Back on the Status tab, click on **Update Customer Info**.
10. Note the results. Refer to Figure 7-145.
11. End of Procedure.

Triple Play Service Management

Customer ID: Cust20 iMG/RG IP Addr: 10.10.147.193 Video/Data Device: 192.168.42.39 Port: 10.2 POTS Device/Port: Unconfigured

Status iMG/RG Ether-like Configuration **Voice Configuration** Statistics Port Log

Customer Info

Video/Data Port Configuration

Device Name: 192.168.42.39 Device Alarm Summary: 0/0/1/1
 Slot.Port: 10.2 Card Status: UP-UP-Online Card Alarm Summary: 0/0/0/0
 Port Status: Up-Up-Online Port Alarm Summary: 0/0/0/0

Voice Configuration

POTS:
 No POTS Port Configured

Derived Voice:

MGC Device (Mgmt. Addr.): 192.168.101.10 Status: UP Device Alarm Summary: 0/0/0/0
 Voice Endpoint: rgvoip-0-d-da-0-2-d9.lab.telesyn.corp
 Voice Endpoint Port: TEL1 IG-CRV: gr303 (gr303)-10 Line Status: Unlock-Enabled
 Voice Endpoint Port: TEL2 IG-CRV: gr303 (gr303)-11 Line Status: Unlock-Enabled

Alerts

Status	Failure Object	Alarm Message	Date/Time

Update Customer Info Add Voice Line

Recent Commands... Close Help

Tue Dec 06 19:56:46 EST 2005 - Polling of 192.168.42.39 successful.

Java Application Window

FIGURE 7-145 Results of Second Voice Line Added

7.10.5.4 Remove Second Voice Line

- Find the iMG/RG for the customer in the iMG/RGs table using various methods:
 - Bring up the iMG/RGs node in the Network Inventory table and do a search (Ctrl-F) on the Customer ID.
 - Bring up the Ports node in the Network Inventory table and do a search (Ctrl-F) on the Customer ID.
- Right click on the iMG/RG or Port and select **View/Modify Details**. This brings up the Triple Play Service Management screen.
- The Select tab should appear by default.
- Select the Voice Configuration tab. Two MGC Info subtabs should appear, one for each voice line. Refer to Figure 7-146.

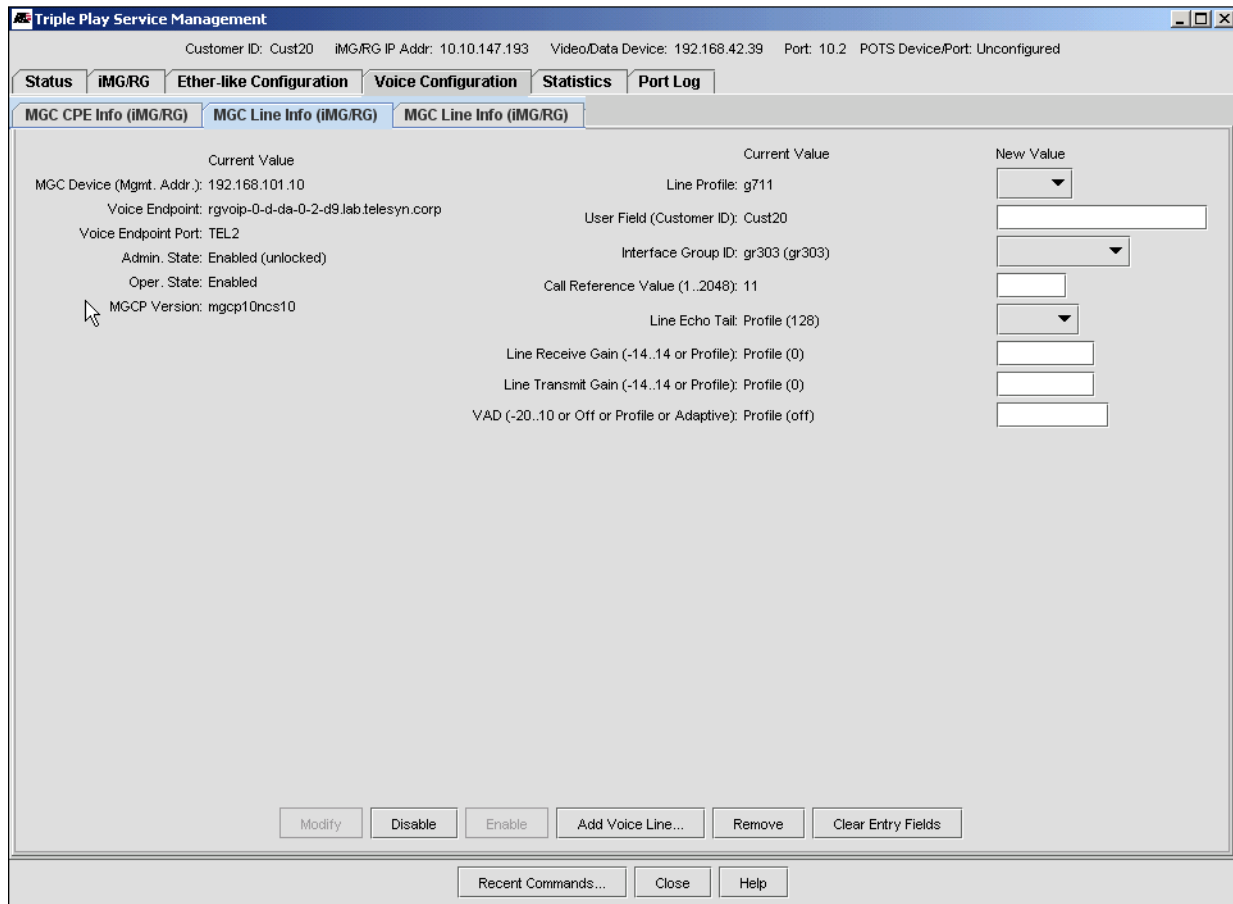

FIGURE 7-146 Two MGC Tabs (one for each Voice Line)

5. Click on **Remove**.
6. When the Confirmation window appears, click on Yes.
7. Note the results. The MGC tab is removed and only one MGC tab remains.
8. End of Procedure.

7.10.5.5 Remove Voice Service (Triple- to Double-Play)

1. Ensure the pre-requisites are met:
 - General Profile available to support the result of customer having no voice service (double play)
2. Right click on the iMG/RG or Port and select **View/Modify Details**. This brings up the Triple Play Service Management screen.
3. Select the iMG/RG - Voice Service tab.
4. For the Voice Service Profile and VOIP Provider Interface, select None, as shown in the following figure.

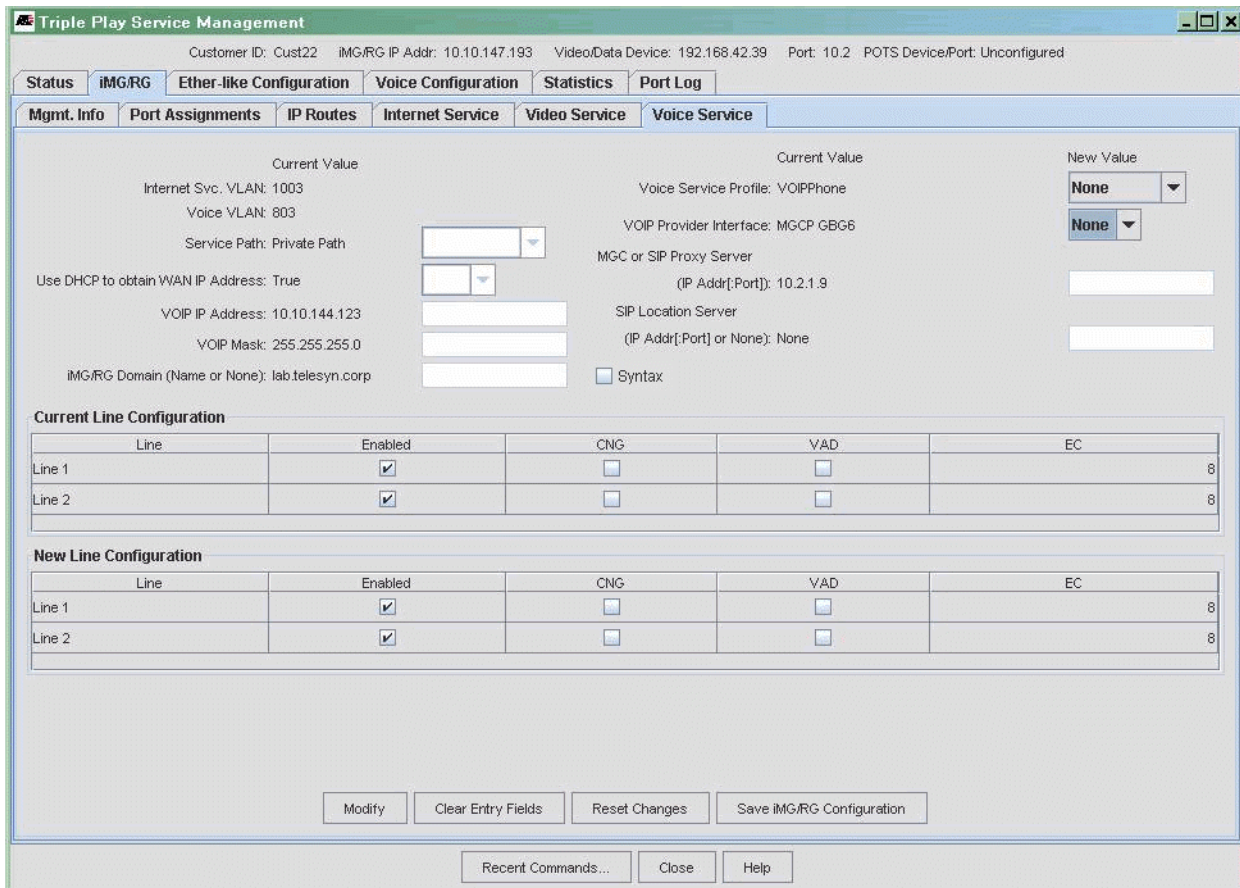

FIGURE 7-147 Deleting Voice Profile

5. Click on **Modify**.

Note: At this point you could select *Save iMG/RG Configuration*, and the customer would have no voice service but still have it configured on the RG.

6. Select the **Mgmt. Info** tab (still under the iMG/RG tab).

7. For the iMG/RG General Profile, select the double-play General Profile the customer will use. Refer to the following figure.

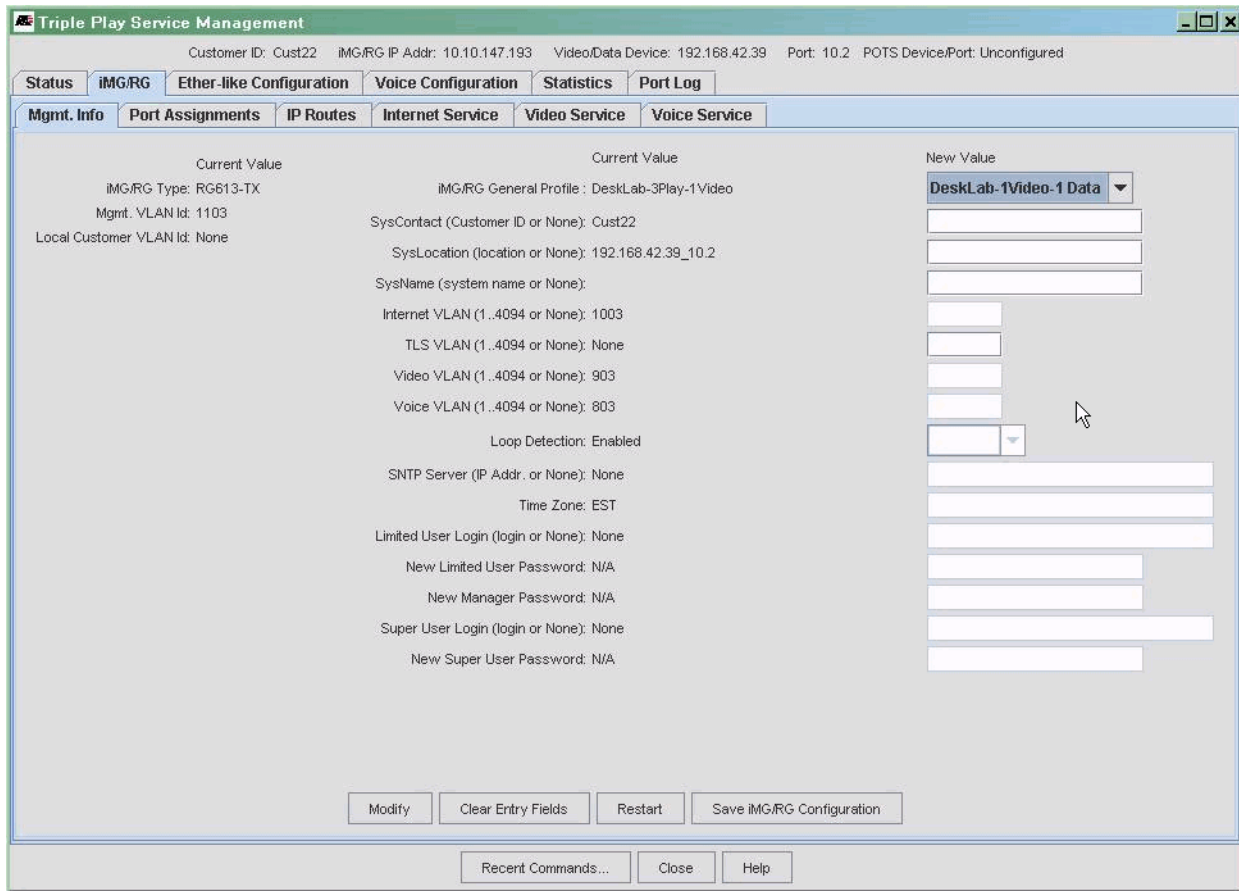

FIGURE 7-148 Customer Using Profile for Double Play (no Voice)

8. Select **Save iMG/RG Configuration**.
9. As the changes takes effect, any phone connected to the RG will no longer have dial tone.
10. END OF PROCEDURE

7.10.6 Provisioning / De-Provisioning Video Service

7.10.6.1 Overview

When a customer has voice and data service (double-play), and wishes to add video service, the use of AlliedView NMS makes this possible, through the use of profiles, with a small number of steps. Moreover, adding or removing a second line for a service is accomplished using only a few GUI screens. Finally, removing the voice service and going (back) to double play involves (re)applying the profile for double-play.

7.10.6.2 Add Video Service (Double-play to Triple-Play)

1. Ensure prerequisites are met:

- Customer uses RG General Profile that enables double-play and has internet and voice profiles
 - RG General - **DeskLab-Voice-1 Data**
 - Internet - **HomeNetworkInet**
 - Voice - **VOIPPhone**

Figure 7-149 shows this configuration. Note the name of the General Profile and that there is no video VLAN.

The screenshot displays the 'Triple Play Service Management' interface. At the top, it shows customer details: Customer ID: Cust22, IMG/RG IP Addr: 10.10.147.193, Video/Data Device: 192.168.42.39, Port: 10.2, and POTS Device/Port: Unconfigured. The 'Video Service' tab is selected, showing a configuration table with columns for 'Current Value' and 'New Value'. The 'IMG/RG General Profile' is set to 'DeskLab-Voice-1Data'. Other fields include 'SysContact' (Cust22), 'SysLocation' (192.168.42.39_10.2), 'SysName', 'Internet VLAN' (1003), 'TLS VLAN' (None), 'Video VLAN' (None), 'Voice VLAN' (803), 'Loop Detection' (Enabled), 'SNTP Server', 'Time Zone' (EST), 'Limited User Login', 'New Limited User Password' (N/A), 'New Manager Password' (N/A), 'Super User Login', and 'New Super User Password' (N/A). Buttons at the bottom include 'Modify', 'Clear Entry Fields', 'Restart', 'Save IMG/RG Configuration', 'Recent Commands...', 'Close', and 'Help'.

FIGURE 7-149 Customer without Video (Double Play)

- There is an RG General Profile for Triple-Play that matches the customer attributes for double-play and adds the necessary attributes for video (especially the video VLAN and routes).
 - RG General - **DeskLab-3Play-1Video**

2. Find the iMG/RG for the customer in the iMG/RGs table using various methods:

- Bring up the iMG/RGs node in the Network Inventory table and do a search (Ctrl-F) on the Customer ID.
 - Bring up the Ports node in the Network Inventory table and do a search (Ctrl-F) on the Customer ID.
3. Right click on the iMG/RG or Port and select **View/Modify Details**. This brings up the Triple Play Service Management screen.
 4. Select the iMG/RG tab, which automatically shows the Mgmt. Info tab.
 5. In the RG General profile pull-down, select the Profile **DeskLab-3Play-1Video**, as shown in Figure 7-150.

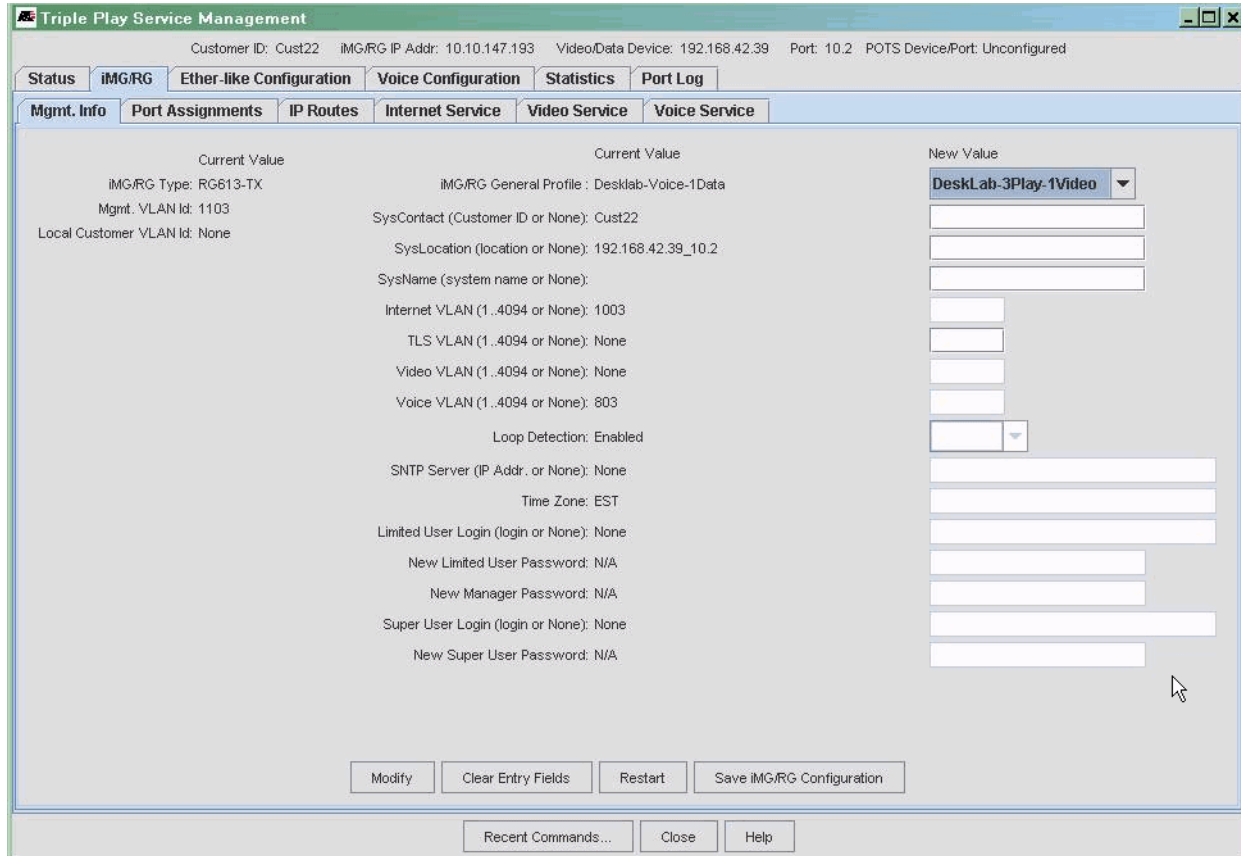

FIGURE 7-150 Applying Different RG General Profile for Triple-Play

6. Click on **Modify**.
7. Note the results - There is now a VLAN provisioned for one video.
8. Still in the Mgmt. Info tab, select the Video Service tab.
9. For the Video Service Profile pull-down, select **Video-Proxy**. Refer to Figure 7-151.

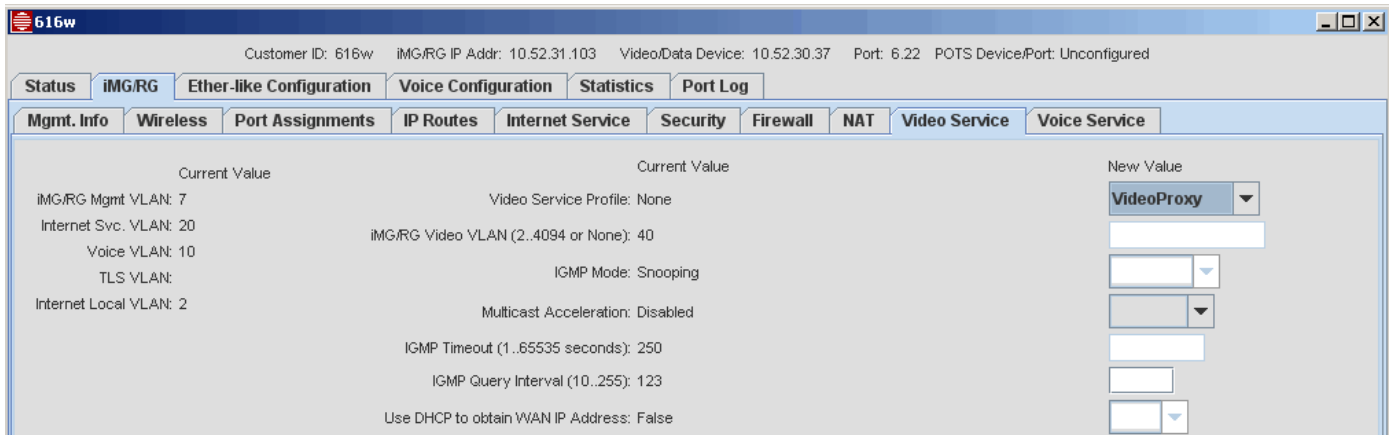

FIGURE 7-151 Applying Video Profile

10. Click on the now active **Modify**.
11. Note the results - The Video Service Profile changes from None to Video-Proxy with the Video Svc. VLAN from the RG GeneralMgmt profile

*Note: Do not make changes to the IGMP values, or the video service will be out of synch with the video profile. (If you do so, and * will appear next to the Profile Name.)*

12. Return to the Mgmt. Info sub-tab.
13. Click on **Save iMG/RG Configuration**.
14. Back on the Status tab, click on **Update Customer Info**.
15. Note the results. Video should no longer be available.
16. End of Procedure.

Note: For the Open Access Model, the same procedure would be used, with the administrator ensuring that there was no conflict in VLAN configuration between the iMG/RG General Profile and the Video Service Profile.

7.10.6.3 Add Second Video Line

1. Ensure the prerequisites are met:
 - An RG General Profile exists that supports more than one video, i.e. **DeskLab-3-play-2Video**.
2. Find the iMG/RG for the customer in the iMG/RGs table using various methods:
 - Bring up the iMG/RGs node in the Network Inventory table and do a search (Ctrl-F) on the Customer ID.
 - Bring up the Ports node in the Network Inventory table and do a search (Ctrl-F) on the Customer ID.
3. Right click on the iMG/RG or Port and select **View/Modify Details**. This brings up the Triple Play Service Management screen.
4. Select the iMG/RG tab, which automatically shows the Mgmt. Info tab.
5. In the RG General profile pull-down, select the Profile **DeskLab-3Play-2Video**, as shown in Figure 7-152.

Triple Play Service Management

Customer ID: Cust22 iMG/RG IP Addr: 10.10.147.193 Video/Data Device: 192.168.42.39 Port: 10.2 POTS Device/Port: Unconfigured

Status iMG/RG Ether-like Configuration Voice Configuration Statistics Port Log

Mgmt. Info Port Assignments IP Routes Internet Service Video Service Voice Service

Current Value	Current Value	New Value
iMG/RG Type: RG613-TX	iMG/RG General Profile: DeskLab-3Play-1Video	DeskLab-3Play-2Video
Mgmt. VLAN Id: 1103	SysContact (Customer ID or None): Cust22	
Local Customer VLAN Id: None	SysLocation (Location or None): 192.168.42.39_10.2	
	SysName (system name or None):	
	Internet VLAN (1..4094 or None): 1003	
	TLS VLAN (1..4094 or None): None	
	Video VLAN (1..4094 or None): 903	
	Voice VLAN (1..4094 or None): 803	
	Loop Detection: Enabled	
	SNTP Server (IP Addr. or None): None	
	Time Zone: EST	
	Limited User Login (login or None): None	
	New Limited User Password: N/A	
	New Manager Password: N/A	
	Super User Login (login or None): None	
	New Super User Password: N/A	

Modify Clear Entry Fields Restart Save iMG/RG Configuration

Recent Commands... Close Help

FIGURE 7-152 Applying Different RG General Profile for Triple-Play (Second Video)

6. Click on **Modify**.
7. Click on **Save iMG/RG Configuration**.
8. Back on the Status tab, click on **Update Customer Info**.
9. Note the results: On the iMG/RG Port Assignments tab, there are two ports for Video, 1 and 3, as shown in the following figure.
10. Restart cpe (iMG/RG).
11. End of Procedure.

The screenshot shows the configuration interface for iMG646MOD5.0. At the top, it displays customer information: Customer ID: iMG646MOD5.0, iMG/RG IP Addr: 10.52.31.102, Video/Data Device: 10.52.30.35, Port: 5.0, and POTS Device/Port: Unconfigured. Below this are navigation tabs for Status, iMG/RG, Ether-like Configuration, Voice Configuration, Statistics, and Port Log. A secondary set of tabs includes Mgmt. Info, Port Assignments, IP Routes, Internet Service, Security, Firewall, NAT, Video Service, Voice Service, CES Service, and Diagnostics. The 'Port Assignments' section is active, showing two tables: 'Current Port Assignments' and 'New Port Assignments'. Both tables list ports 1 through 6 with their respective services (Video, Internet, or None), speeds (Autonegotiate), and rate limits (None). An 'Advanced Port Params...' button is located at the bottom left.

Port	Service	Speed	Upstream Rate Limit (kbps)	Downstream Rate Limit (kbps)	Admin. State
Port 1	Video	Autonegotiate	None	None	E
Port 2	Internet	Autonegotiate	None	None	E
Port 3	Video	Autonegotiate	None	None	E
Port 4	None	Autonegotiate	None	None	E
Port 5	None	Autonegotiate	None	None	E
Port 6	None	Autonegotiate	None	None	E

FIGURE 7-153 Results of Second Video Line Added (Ports)

7.10.6.4 Remove Second Video Line

1. Ensure the prerequisites are met:
 - An RG General Profile exists that supports more than one video, i.e. **DeskLab-3-play-1Video**.
2. Find the iMG/RG for the customer in the iMG/RGs table using various methods:
 - Bring up the iMG/RGs node in the Network Inventory table and do a search (Ctrl-F) on the Customer ID.
 - Bring up the Ports node in the Network Inventory table and do a search (Ctrl-F) on the Customer ID.
3. Right click on the iMG/RG or Port and select **View/Modify Details**. This brings up the Triple Play Service Management screen.
4. Select the iMG/RG tab, which automatically shows the Mgmt. Info tab.
5. In the RG General profile pull-down, select the Profile **DeskLab-3Play-1Video**, as shown in Figure 7-154.

Triple Play Service Management

Customer ID: Cust22 iMG/RG IP Addr: 10.10.147.193 Video/Data Device: 192.168.42.39 Port: 10.2 POTS Device/Port: Unconfigured

Current Value	Current Value	New Value
iMG/RG Type: RG613-TX	iMG/RG General Profile : DeskLab-3Play-2Video	DeskLab-3Play-1Video
Mgmt. VLAN Id: 1103	SysContact (Customer ID or None): Cust22	<input type="text"/>
Local Customer VLAN Id: None	SysLocation (location or None): 192.168.42.39_10.2	<input type="text"/>
	SysName (system name or None):	<input type="text"/>
	Internet VLAN (1,4094 or None): 1003	<input type="text"/>
	TLS VLAN (1,4094 or None): None	<input type="text"/>
	Video VLAN (1,4094 or None): 903	<input type="text"/>
	Voice VLAN (1,4094 or None): 803	<input type="text"/>
	Loop Detection: Enabled	<input type="text"/>
	SNTP Server (IP Addr. or None): None	<input type="text"/>
	Time Zone: EST	<input type="text"/>
	Limited User Login (login or None): None	<input type="text"/>
	New Limited User Password: N/A	<input type="text"/>
	New Manager Password: N/A	<input type="text"/>
	Super User Login (login or None): None	<input type="text"/>
	New Super User Password: N/A	<input type="text"/>

FIGURE 7-154 Applying Different RG General Profile for Triple-Play (Remove Second Video)

6. Click on **Modify**.
7. Click on **Save iMG/RG Configuration**.
8. Back on the Status tab, click on **Update Customer Info**.
9. Note the results. In the Port Assignments tab, there is only one video port. Refer to the following figure.
10. At the iMG/RG/Mgmt. Info tab, select **Save iMG/RG Configuration**.
11. Restart the CPE (iMG/RG)
12. End of Procedure.

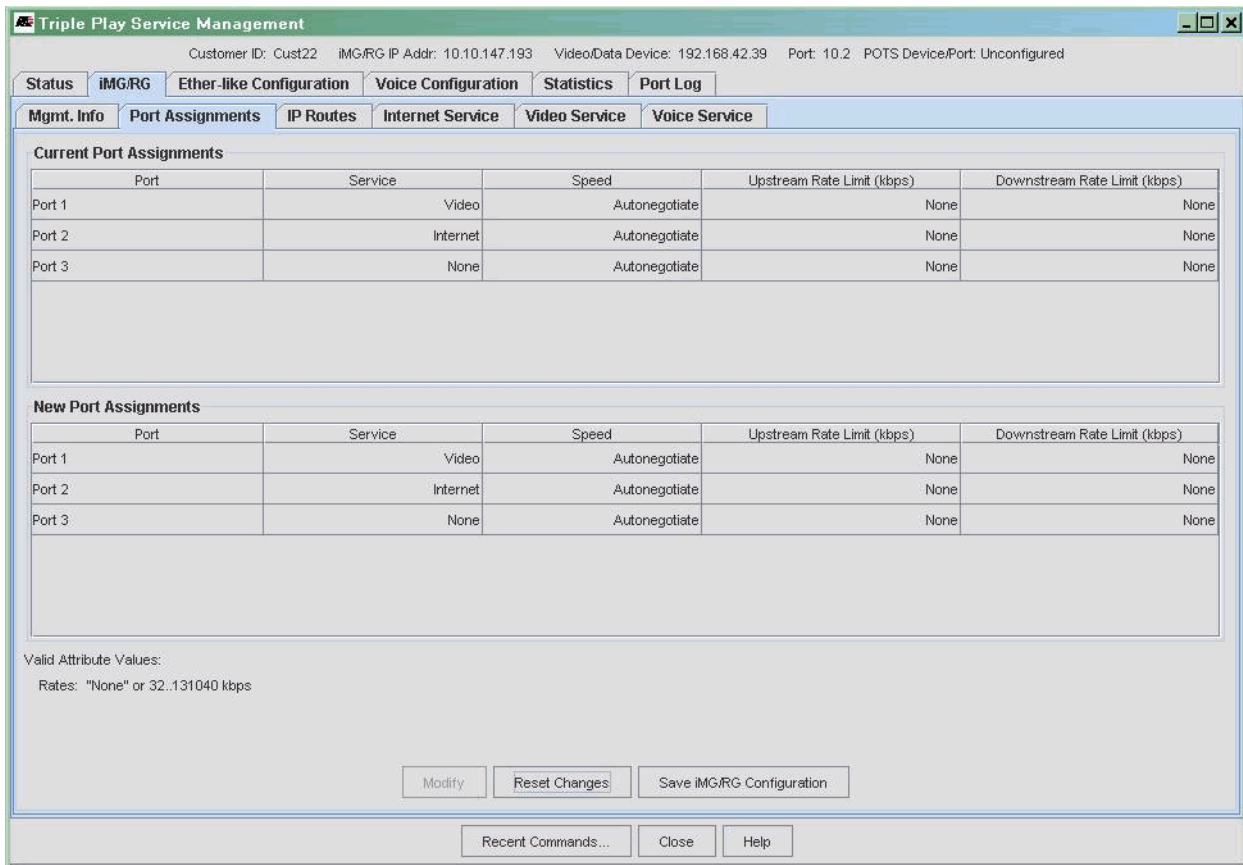

FIGURE 7-155 Results of Second Video Line Removed

7.10.6.5 Remove Video Service (Triple- to Double-Play)

1. Ensure the pre-requisites are met:
 - General Profile available to support the result of customer having no video service (double play)
2. Right click on the iMG/RG or Port and select **View/Modify Details**. This brings up the Triple Play Service Management screen.
3. Select the iMG/RG - Video Service tab.
4. For the Video Service Profile and IGMP Mode, select **None**, as shown in the following figure.

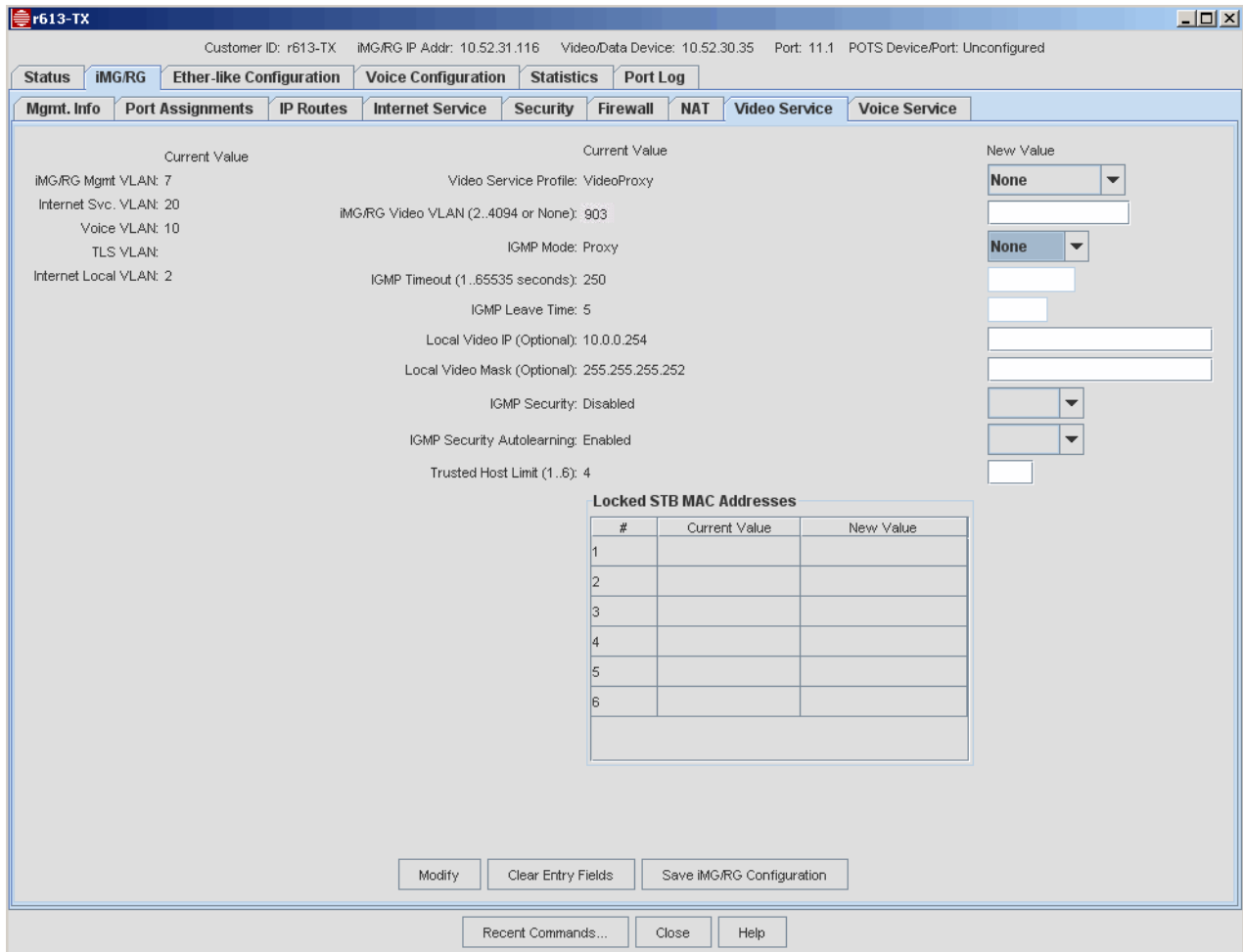

FIGURE 7-156 Deleting Video Profile

5. Click on **Modify**.

Note: At this point you could select **Save iMG/RG Configuration**, and the customer would have no video service but still have it configured on the RG.

6. Select the Mgmt. Info tab (still under the iMG/RG tab).

7. For the iMG/RG General Profile, select the double-play General Profile the customer will use. Refer to the following figure.

Triple Play Service Management

Customer ID: Cust22 iMG/RG IP Addr: 10.10.147.193 Video/Data Device: 192.168.42.39 Port: 10.2 POTS Device/Port: Unconfigured

Status | **iMG/RG** | Ether-like Configuration | Voice Configuration | Statistics | Port Log
 Mgmt. Info | Port Assignments | IP Routes | Internet Service | Video Service | Voice Service

Current Value	Current Value	New Value
iMG/RG Type: RG613-TX	iMG/RG General Profile : DeskLab-3Play-1Video	DeskLab-Voice-1Data
Mgmt. VLAN Id: 1103	SysContact (Customer ID or None): Cust22	
Local Customer VLAN Id: None	SysLocation (location or None): 192.168.42.39_10.2	
	SysName (system name or None):	
	Internet VLAN (1..4094 or None): 1003	
	TLS VLAN (1..4094 or None): None	
	Video VLAN (1..4094 or None): 903	
	Voice VLAN (1..4094 or None): 803	
	Loop Detection: Enabled	
	SNTP Server (IP Addr. or None): None	
	Time Zone: EST	
	Limited User Login (login or None): None	
	New Limited User Password: N/A	
	New Manager Password: N/A	
	Super User Login (login or None): None	
	New Super User Password: N/A	

Modify | Clear Entry Fields | Restart | Save iMG/RG Configuration
 Recent Commands... | Close | Help

FIGURE 7-157 Customer Using Profile for Double Play (no Video)

8. Select **Save iMG/RG Configuration**.
9. Back on the Status tab, click on **Update Customer Info**.
10. Note the results: any video connected to the RG will no longer work.
11. END OF PROCEDURE

7.10.7 Change Quality of Existing Data Service

This will be supplied in a future release.

7.10.8 Reprovision Existing iMG/RG so incorporated into AlliedView NMS

In this scenario, the iMG/RG has already been provisioned either locally or using the ZTC components. If the user wishes to take the existing iMG/RG and transfer control over to the NMS, the NMS will make a best effort and try to ensure that all of the features on the iMG/RG can be controlled by the NMS.

When transferring control over, the user should be aware of the following NMS features:

- The NMS shows only one service per LAN port.
- The NMS can't tell the difference between bridged internet service and video without snooping, unless the service is named "InternetIP" or "VideoIP".
- The NMS can't tell the difference between bridged internet service and TLS, unless the service is named "InternetIP" or "TLSIP".
- The NMS supports a single Internet service.
- The NMS only supports PPPoE on Internet service.
- The NMS only supports rate limiting on Internet service.
- All LAN ports are set as untagged.
- All service VLANs must be tagged on the WAN ports.
- Any parameters (especially voice) not supported by the NMS may or may not be preserved when changing over to the NMS.

7.10.9 De-Provision iMG/RG from AlliedView NMS

7.10.9.1 Overview (Access Island and Open Access Considerations)

When the user wishes to de-provision the iMG/RG, there are two options:

- From the port table, select the port and then *Port -> De-provision Customer/port*
- From the iMG/RG table, select the iMG/RG and then *Operations -> De-provision Customer iMG/RG*

Either choice brings up the **De-provision Ports** form, as shown in Figure 7-158.

Customer ID: Search

iMG/RGs

Customer ID	IP Address	Access Device/Port
Demo	10.4.1.253	10.5.1.102_19.0

Ports

Customer ID	Device	Port	Type
Demo	10.5.1.102	19.0	Ether-like(Optical Fast Ethernet)

Voice Lines

Customer ID	Call Agent	IG	CRV	Gateway	Port
Demo	192.168.101.10	1	3	rgvoip-0-dcl-da-3-99-2d.lab.tel...	0

Schedule

Now
 Hold
 Schedule:
 Dec 7, 2005
 4
 12
 PM

Java Application Window

FIGURE 7-158 De provision Ports Form

There are three options for deletion:

- iMG/RG - Deletes the Customer ID and all associated profiles. The user can now provision a new Customer ID for the iMG/RG and build a service set from profiles.
- Ports (iMAP) - De-provisions the iMG/RG, the associated profiles, and the associated ports. If a POTS24 was being used to provide voice service, the POTS24 port would appear here as well.
- Voice Line - If there is a connection to the GenBand, the attributes associated with it are shown here. If more than one voice line is being used, all would appear here.

Moreover, choosing these options depends on what the user is trying to do:

- The user wishes to de-provision the RG (put back in the box), and then be able to re-provision the RG on the same Access Island. In this case, the RG, when taken out of the box and re-provisioned, would be using the same RGMgmt VLAN.
- The user wishes to de-provision the RG (put back in the box), and then be able to re-provision the RG on a different Access Island. In this case, the RG, when taken out of the box and re-provisioned, would need to start with the default (bootstrap) VLAN for DHCP discovery.
- The user has an open access model, and so the strategy depends on whether the same RGMgmt VLAN is used for all iMG/RGs in the network.

7.10.9.2 De provision the iMG/RG (same Access Island)

To de-provision the iMG/RG, perform the following steps:

1. Find the RG you wish to de-provision (usually using the Customer ID from the iMG/RG table.).
2. Select the iMG/RG and then *Operations -> De-provision Customer iMG/RG*. The De-provision Port form appears.

3. Select the Customer ID option for all three panels, then click on **De-Provision**.
4. The RG will reboot.
5. In the iMG/RG table, the Customer ID is deleted and all profile information is deleted. Refer to Figure 7-159

Customer ID	IP Address	Type	Release	Upstream Port	Name	Gen Prof.	Inet Prof.	Video Prof.
VTCBootStrap	10.4.1.187	RG634-A	3.3.0-60	10.5.1.102_4.11	RG_113077...			
VTCBootStrap	10.4.1.189	RG634-A	3.3.0-60	10.5.1.102_4.8	RG_113077...			
VTCBootStrap	10.4.1.190	RG634-A	3.3.0-60	10.5.1.102_4.5	RG_113077...			
VTCBootStrap	10.4.1.188	RG634-A	3.3.0-60	10.5.1.102_4.7	RG_113077...			
VTCBootStrap	10.4.1.191	RG634-A	3.3.0-60	10.5.1.102_4.0	RG_113077...			
	10.4.1.186	RG634-A	3.3.0-61	10.5.1.102_4.2	RG_113108...			
	10.10.147.193	RG613-TX	2.3.0-59	192.168.42.39_10.2	RG_113355...			
	10.10.147.195	RG634-A	3.3.0-61	192.168.42.39_8.9	RG_113356...			
Demo	10.4.1.253	IMG646-BD-...	2.3.0-59	10.5.1.102_19.0	RG_113380...NELab-3Play-1V...BasicHomeInet			Video-Flooding

FIGURE 7-159 iMG/RG Table after Deleting RG

6. To remove the port-RG association, right click on the RG and select **Delete Object and Traces**. Refer to the following figure.

Note: If iMG/RG equipment is to remain unprovisioned on this port temporarily (waiting for new customer to move in etc...), then the deletion of the RG object and traces is optional.

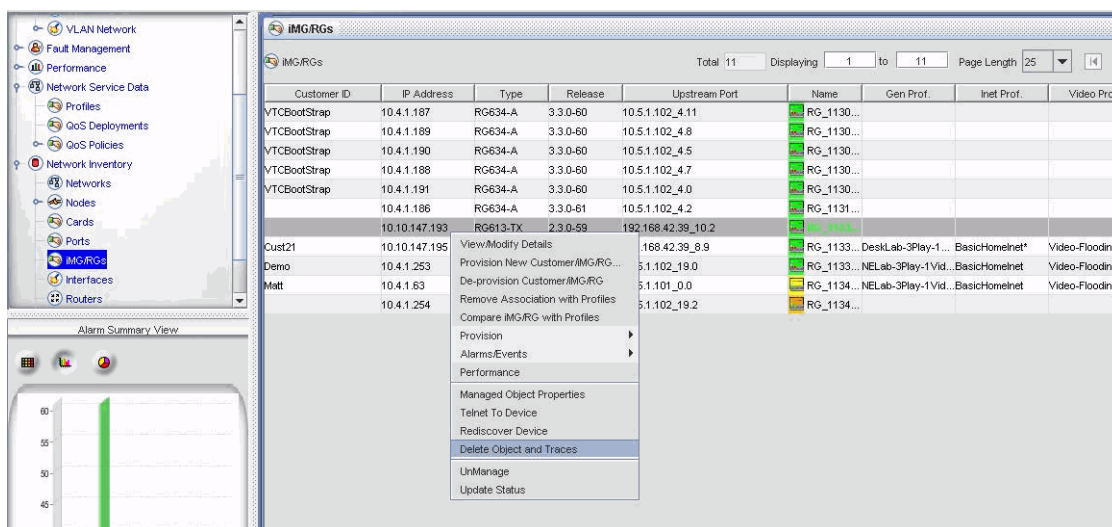

FIGURE 7-160 Delete RG-Port Association (Delete Object and Traces)

7. The user can now either:
 - Place the iMG/RG back in its box for storage. When the RG is reconnected, it must be to a port in the **same** Access Island.
 - Transfer the RG to another iMAP port in the same Access Island.
8. End of Procedure.

7.10.9.3 De provision the iMG/RG (Different Access Island)

1. Find the RG you wish to de-provision (usually using the Customer ID from the iMG/RG table).
2. Select the iMG/RG and then **Operations -> De-provision Customer iMG/RG**. The De-provision Port form appears.
3. Select the Customer ID option for the iMG/RGs and **Voice Lines** only, then click on **De-Provision**.

4. The RG will reboot.
5. In the iMG/RG table, the Customer ID is deleted and all profile information is deleted. Refer to Figure 7-161.

Customer ID	IP Address	Type	Release	Upstream Port	Name	Gen Prof.	Inet Prof.	Video Prof.
VTCBootStrap	10.4.1.187	RG634-A	3.3.0-60	10.5.1.102_4.11	RG_113077...			
VTCBootStrap	10.4.1.189	RG634-A	3.3.0-60	10.5.1.102_4.8	RG_113077...			
VTCBootStrap	10.4.1.190	RG634-A	3.3.0-60	10.5.1.102_4.5	RG_113077...			
VTCBootStrap	10.4.1.188	RG634-A	3.3.0-60	10.5.1.102_4.7	RG_113077...			
VTCBootStrap	10.4.1.191	RG634-A	3.3.0-60	10.5.1.102_4.0	RG_113077...			
	10.4.1.186	RG634-A	3.3.0-61	10.5.1.102_4.2	RG_113108...			
	10.10.147.193	RG613-TX	2.3.0-59	192.168.42.39_10.2	RG_113355...			
	10.10.147.195	RG634-A	3.3.0-61	192.168.42.39_8.9	RG_113356...			
Demo	10.4.1.253	IMG646-BD...	2.3.0-59	10.5.1.102_19.0	RG_113380...NELab-3Play-1V...BasicHomeNet			Video-Flooding

FIGURE 7-161 iMG/RG Table after Deleting RG

6. Access the device using telnet. Right click on the iMG/RG in the iMG/RG table and select **Telnet to Device**. Refer to the following figure.

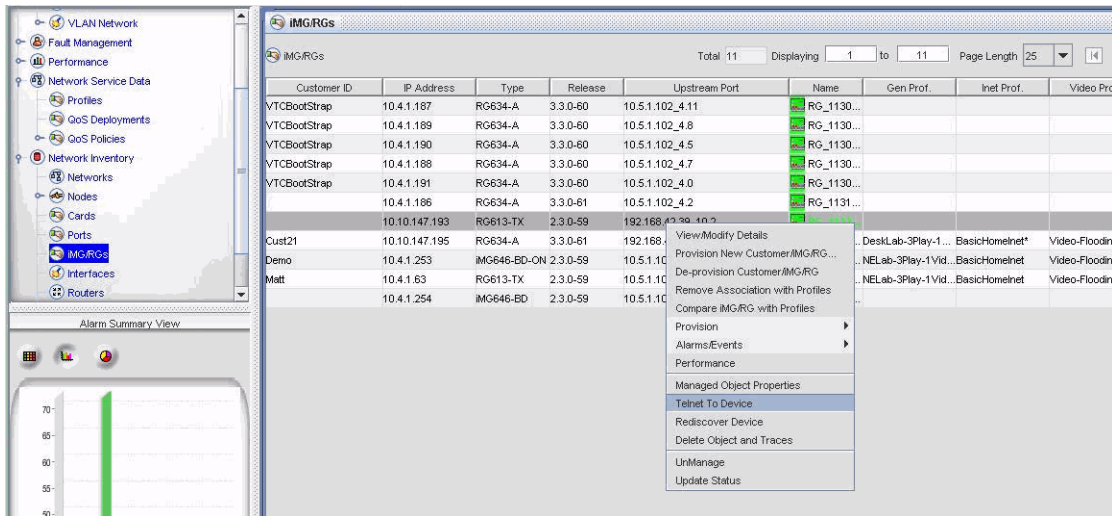

FIGURE 7-162 Using telnet to Access the RG

7. Login to the iMG/RG.
8. Set back to factory defaults (>sys config set factory)
9. You can now unplug the RG and place it back in its box.
10. Return to the De-Provision Ports Form.
11. This time select the Ports panel.
12. Right click on the iMG/RG and select **Delete Object and Traces**, as shown in the following figure.

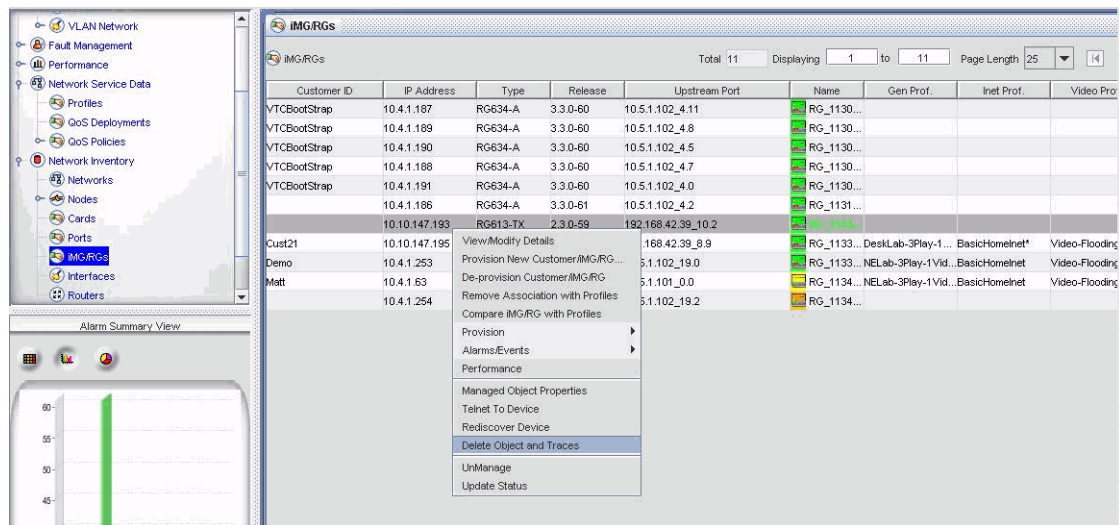

FIGURE 7-163 Delete RG-Port Association (Delete Object and Traces)

13. When the RG is reconnected, the default VLAN for the RG is used at the start for DHCP discovery. Therefore, this would most likely be for connecting the RG to an iMAP that is in **any** Access Island than where it was de-provisioned.

14. END OF PROCEDURE

7.10.9.4 De provision the iMG/RG (Open Access)

In the Open Access Model, it is the use of the RGMgmt VLAN that determines the strategy to follow:

- If the iMG/RG is to be reconfigured where the same RGMgmt VLAN is used, the iMG/RG would not be set back to its factory settings before re-provisioning, similar to 7.10.9.2.
- If the iMG/RG is to be reconfigured where a different RGMgmt VLAN is used, the iMG/RG would be set back to its factory settings before re-provisioning, similar to 7.10.9.3.

7.10.10 Changing a Customer ID

7.10.10.1 Overview

Section 7.2.7 listed the naming conventions to follow for Customer IDs. To change a Customer ID, the administrator must enter the changed ID for all three configuration areas (tabs) on the Triple Play Service Management form.

- Connection Type - Ether-like, ADSL, or ONU
- iMG/RG
- Voice

All three are filled in the Service Management form.

Caution: *The customer ID value must be filled in for all three areas before the form is closed, and the value must be the same for all three areas. Otherwise, the value will not be propagated to all three areas correctly.*

7.10.10.2 Procedure

1. Bring up the Triple Service Management Form for the Customer ID. To do this, select and right click on **View/Modify Details** with one of the following:
 - The row with the current Customer ID from the Ports Inventory table.
 - The row with the current Customer ID from the iMG/RG Inventory table
 - The iMG/RG icon from the relevant IP Network MAP
2. Select the connection type tab, such as **Ether-like Configuration -> General**, and fill in the changed Customer ID.
3. Select the **iMG/RG -> Mgmt. Info** tab, and fill in the changed Customer ID.
4. Select the **Voice Configuration -> protocol Info** tab, and fill in the changed Customer ID.

Note: The customer ID is not on the CPE sub-tab for the Voice Configuration.

5. Click on the **Modify** button to make the changes take effect.
6. You can now close the Form.

7.10.11 iMG/RG Recovery

This procedure is used when the iMG/RG has gone into Recovery Mode. This could happen, for example, if during the middle of an upgrade procedure the iMG/RG lost power and as a result went into Recovery mode.

Note: The iMG/RG will have a constant red light on when it has entered Recovery mode.

There are two procedures that can be used, depending on whether the existing RG is to be recovered or a new iMG.RG is to be swapped.

7.10.11.1 Recover Existing iMG/RG

1. Add the Bootstrap VLAN to the subscriber's iMAP port.
2. The iMG/RG should be able to contact a DHCP server and get an IP address
3. Using a tool called the Windows Loader, input the iMG/RG IP Address and the telnet password, default value "friend".

Note: For information on the Windows Loader, refer to the Software Reference Manual for the AT-RG600. This document can be found on the Allied Telesis web site.

4. The RG should then reboot and go back to Normal mode, with the bootstrap loading on the RG-mgmt VLAN.
5. Using the AlliedView NMS application (Device Backup/Restore), restore the last saved configuration file for the RG.
6. The bootstrap VLAN can now be removed from the subscriber's port.

7.10.12 Recover using new Hardware

Use this procedure to replace suspected bad iMG hardware unit.

7.10.12.1 Prerequisites

- Ensure iMG hardware model of new unit matches model of unit to be replaced (old unit).
- Ensure the new iMG unit has not been previously managed by the target NMS, to prevent possible complications.
- Ensure iMG software boot load release matches release of iMG to be replaced.
- Ensure the new iMG unit contains only the "factory" system configuration file.
- Ensure the old iMG configuration has been backed up recently. If a current backup is not available, do **not** use the procedure in 7.10.12.2. Instead, do the following:
 1. Record all subscriber configuration information
 2. Deprovision the subscriber (refer to 7.10.9).
 3. Provision using a new iMG hardware unit, and the recorded information (refer to 7.6).

7.10.12.2 Procedure

1. Add the Bootstrap VLAN to the subscriber's iMAP port.
2. Swap the existing iMG/RG with a new one.
 1. Power off the old iMG unit, and replace with new unit, connecting all cables.
 2. Power on the new unit.
3. The iMG/RG should be able to contact a DHCP server and get an IP address and go through the bootstrap process.
4. The AlliedView NMS should discover the new iMG/RG and restore the last saved config file automatically.
5. The AlliedView NMS should then remove the bootstrap VLAN automatically.
6. Verify iMG management and all provisioned services.

7.10.13 Configuring multi-service VLAN

For a description of a multi-service VLAN model, refer to 7.6.7. This subsection gives procedures that involve creating three possible configurations. For all of the procedures the following apply:

- The port configuration for each IMG is the same (two voice, two video, one data). This allows the same General profile to be used for all configurations, even if the type of iMG (EPON, FX, ADSL) is different.
- The VLANs involved should have already been created.
- The port Profile should have already been created, although it is not included here.

7.10.13.1 Creating a Voice and Video/Data VLAN (Configuration 1)

In this configuration, the Voice VLAN is on a separate VLAN, but video and data share a single VLAN. Refer to the following figure and notes in 7.10.13 before performing the procedure.

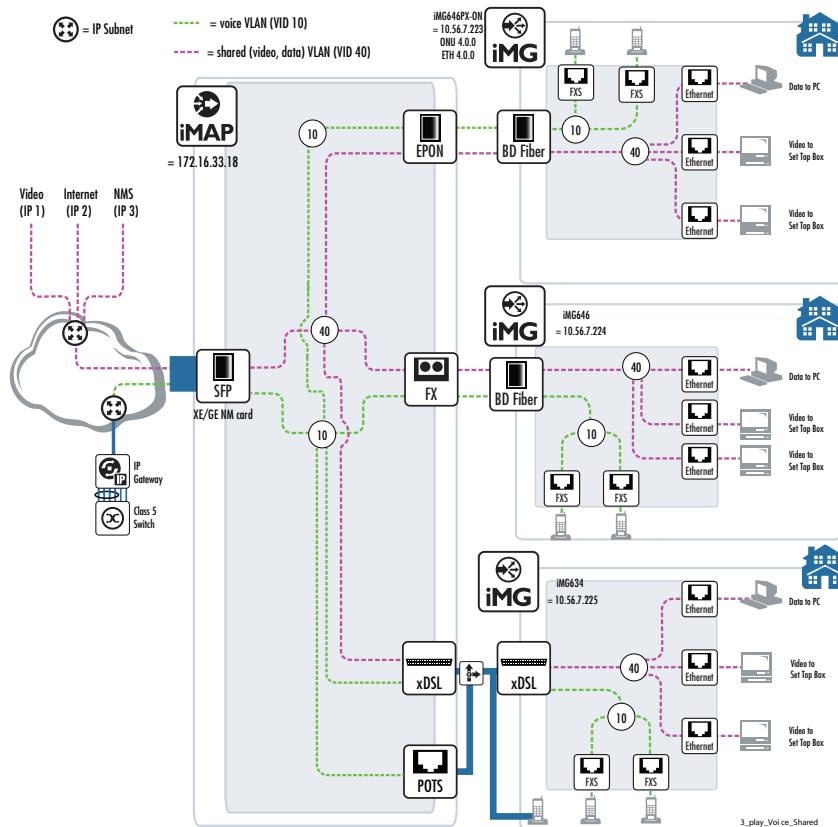

FIGURE 7-164 Multi-service (Video, Data) VLAN - Configuration 1

1. Create the appropriate iMG profiles. Refer to the following table and figures.

TABLE 7-32 iMG Forms for Voice, Video/Data VLAN Configuration

Form	Name	Attributes	Reference
General	iMG_one_data_two_video		Figure 7-165 - Mgmt. Info Figure 7-166 - Port Assignment
Internet	iMG_data_shared_VLAN_vidoe		Figure 7-167
Video	iMG_video_shared_data		Figure 7-168

TABLE 7-32 iMG Forms for Voice, Video/Data VLAN Configuration

Voice	iMG_MGCP_two_line	Since this is not a shared VLAN and uses MGCP, an existing form can be used	Figure 7-169
-------	-------------------	---	--------------

The screenshot shows the 'Create Profile' configuration window with the following details:

- Profile Name:** iMG_one_data_two_video
- Profile Type:** RG General
- Profile Attributes:**
 - Mgmt. Info Tab:**
 - Profile Scoping: None
 - IMG/RG Bootstrap VLAN Id (1..4094 or None): 1
 - IMG/RG Mgmt VC/VLAN Id (2..4094): 7
 - Include Service VLANs in Profile: False
 - IMG/RG Internet VC/VLAN Id (2..4094 or None):
 - IMG/RG Video VC/VLAN Id (2..4094 or None):
 - IMG/RG Voice VC/VLAN Id (2..4094 or None):
 - IMG/RG CES VC/VLAN Id (2..4094 or None):
 - System Power Management: Disabled
 - Wireless Tab:**
 - Loop Detection: Disabled
 - SNTP Server (IP Addr. or None): None
 - Daylight Saving: Disabled
 - Time Zone: EST
 - Limited User Login (login or None): None
 - New Limited User Password:
 - New Manager Password:
 - Super User Login (login or None): None
 - New Super User Password:
 - Split Management: Disabled
 - Subscriber User Login: admin
 - New Subscriber User Password: admin
- Mgmt. Subnets:**

Name	Subnet Addr.	Mask	Start Addr.	End Addr.

- Footer:**
- Copy values from profile: iMG_one_data_two_video
- Buttons: Create, Cancel, Help

FIGURE 7-165 General Form for Multi-service VLAN - Mgmt. Info Tab

Create Profile _ □ ×

Profile Name: Profile Type: RG-General

Profile Attributes

Mgmt. Info | **Wireless** | **Port Assignment** | IP Routes

Attribute New Value

Port Assignment: **Settings** ▼

PortAssignments

Port	Service	Speed	Upstream Rate Limit (kbps)	Downstream Rate Limit (kb...	Admin. State
Port 1	Internet	Autonegotiate	None	None	Disabled
Port 2	Video	Autonegotiate	None	None	Disabled
Port 3	Video	Autonegotiate	None	None	Disabled
Port 4	None	Autonegotiate	None	None	Disabled
Port 5	None	Autonegotiate	None	None	Disabled
Port 6	None	Autonegotiate	None	None	Disabled
Wireless	None				
HPNA	None		None	None	Disabled
G-Lan	None	Autonegotiate	None	None	Disabled

Advanced Port Params...

Copy values from profile: ▼

FIGURE 7-166 General Form for Multi-service VLAN - Port Assignment Tab

Create Profile

Profile Name: Profile Type: RG Internet

Profile Attributes

General Internet Info | Security | Firewall | NAT

Attribute	New Value
Internet Service Type:	Routed Service
Include Internet VLAN in Profile:	True
iMG/RG Internet VLAN Id (2..4094):	40
Use PPPoE:	False
iMG/RG Local Customer VLAN Id (2..4094):	2
Use DHCP to obtain WAN IP Address:	True
DNS Servers (list of IP Addr. or None):	172.16.72.55
Local IP Address:	<input type="text"/>
Local Mask:	<input type="text"/>
Local DHCP Start IP Address:	<input type="text"/>
Local DHCP End IP Address:	<input type="text"/>

Copy values from profile:

FIGURE 7-167 Internet Form for Multi-service VLAN - General Internet Info Tab - Configuration 1

Create Profile

Profile Name: Profile Type: RG Video

Profile Attributes

General Video Info

Attribute	New Value
Include Video VLAN in Profile:	True
iMG/RG Video VC/VLAN ID (2..4094):	40
Use DHCP to obtain WAN IP Address:	
IGMP Mode:	None
Multicast Acceleration:	Disabled
IGMP Timeout (1..65535 seconds):	
IGMP Leave Time:	
IGMP Security:	Enabled
IGMP Security Autolearning:	Enabled
Trusted Host Limit (1..6):	2
IGMP Default Fast Leave:	Enabled

Copy values from profile: VIDEO_MultVC Copy

Create Cancel Help

FIGURE 7-168 Video Form for Multi-service VLAN - Configuration 1

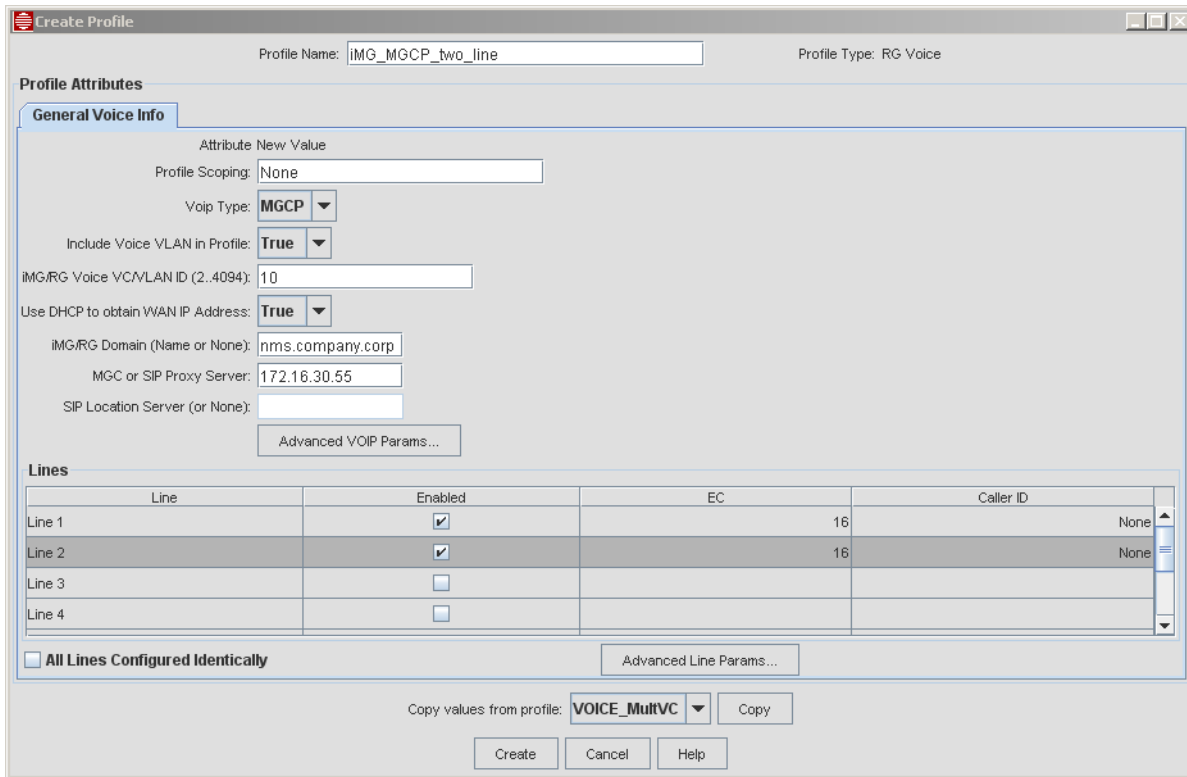

FIGURE 7-169 Voice Form for Multi-service VLAN - Configuration 1

2. Data fill the Triple-Play Form. Since there are three different customers and types of interfaces, the Customer ID for each must be unique, and the slot.Port will be different. (The iMAP could be the same if all of the interface cards were on the same iMAP. Refer to the following table.)

TABLE 7-33 Triple Play Forms for Voice, Video/Data VLAN Configuration

iMG Type	Attributes	Reference
EPON (iMG646PX-ON)		Figure 7-170 - Mgmt. Info
FX (iMG646)		Figure 7-171
ADSL (iMG634)		Figure 7-172

Provision New Triple Play Customer

Description (Customer ID):

iMG/RG General Configuration

iMG/RG General Profile: iMG/RG MAC Address:

Video/Data Configuration

Access Device: Slot Port: (ONU) ONU MAC Addr.: Port Profile:

Allowed IP Addr. Ranges: IP Addr.# Bits (e.g. 192.4.1.0/24)

Range #1: Range #2: Range #3:
 Range #4: Range #5: Range #6:

Data Svcs. Config: Internet Svc. Profile:

Video Service Config: Video Svc. Profile:

Voice Configuration

Derived Voice: Derived Voice Svc. Profile:

Schedule

Now Hold Schedule:

FIGURE 7-170 Triple-Play Form EPON Interface - Configuration 1

The screenshot shows the 'Provision New Triple Play Customer' window for an FX configuration. The Description (Customer ID) is 'Cust_shared_data_video_FX'. The iMG/RG General Profile is 'iMG_one_data_two_video'. Under Video/Data Configuration, the Access Device is '10.52.30.37' and Slot Port is '5.1'. There are six empty input fields for Allowed IP Addr. Ranges. The Internet Svc. Profile is 'iMG_data_shared_VLAN_video' and the Video Svc. Profile is 'iMG_video_shared_data'. There are six empty dropdown menus for Allowed STB MAC Adrs. Under Voice Configuration, the Derived Voice Svc. Profile is 'iMG_MGCP_two_line'. The Schedule section has radio buttons for 'Now', 'Hold', and 'Schedule', with 'Now' selected. The date is 'Jun 8, 2007', time is '2:41 PM'. Buttons at the bottom include 'Provision', 'Recent Commands...', 'Close', and 'Help'.

FIGURE 7-171 Triple-Play Form FX Interface - Configuration 1

The screenshot shows the 'Provision New Triple Play Customer' window for an ADSL configuration. The Description (Customer ID) is 'Cust_shared_data_video_ADSL'. The iMG/RG General Profile is 'iMG_one_data_two_video'. Under Video/Data Configuration, the Access Device is '10.52.30.36' and Slot Port is '17.2'. There are six empty input fields for Allowed IP Addr. Ranges. The Internet Svc. Profile is 'iMG_data_shared_VLAN_video' and the Video Svc. Profile is 'iMG_video_shared_data'. There are six empty dropdown menus for Allowed STB MAC Adrs. Under Voice Configuration, the POTS Access Device is '10.52.30.36' and Slot Port is '20.0'. The POTS Call Agent is 'Unconfigured'. The Derived Voice Svc. Profile is 'iMG_MGCP_two_line'. The Schedule section has radio buttons for 'Now', 'Hold', and 'Schedule', with 'Now' selected. The date is 'Jun 8, 2007', time is '2:41 PM'. Buttons at the bottom include 'Provision', 'Recent Commands...', 'Close', and 'Help'.

FIGURE 7-172 Triple-Play Form ADSL Interface - Configuration 1

7.10.13.2 Creating a Data and Video/Voice VLAN (Configuration 2)

In this configuration, the Data VLAN is on a separate VLAN, and video and voice share a single VLAN. Refer to the following figure and notes in 7.10.13 before performing the procedure.

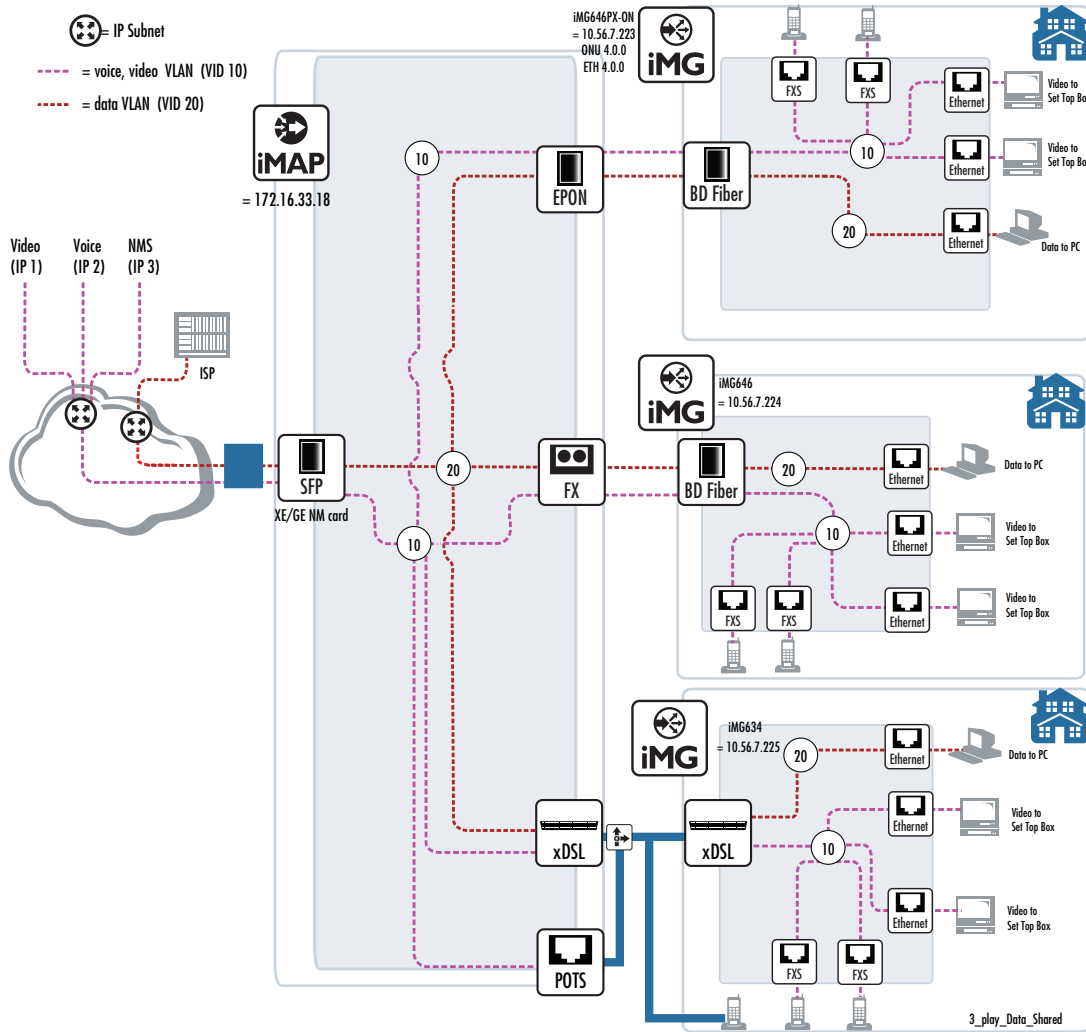

FIGURE 7-173 Multi-service (Video, Video) VLAN (Configuration 2)

1. Create the appropriate iMG profiles. Refer to the following table and figures.

TABLE 7-34 iMG Forms for Voice, Video/Data VLAN (Configuration) 2

Form	Name	Attributes	Reference
General	iMG_one_data_two_video	Since the port and VLAN configuration is the same for all iMGs, the same General Form is used in all configurations	Figure 7-165 - Mgmt. Info Figure 7-166 - Port Assignment
Internet	iMG_Data_only_VLAN20		Figure 7-174
Video	iMG_Video_shared_voice		Figure 7-175
Voice	iMG_voice_shared_video		Figure 7-176

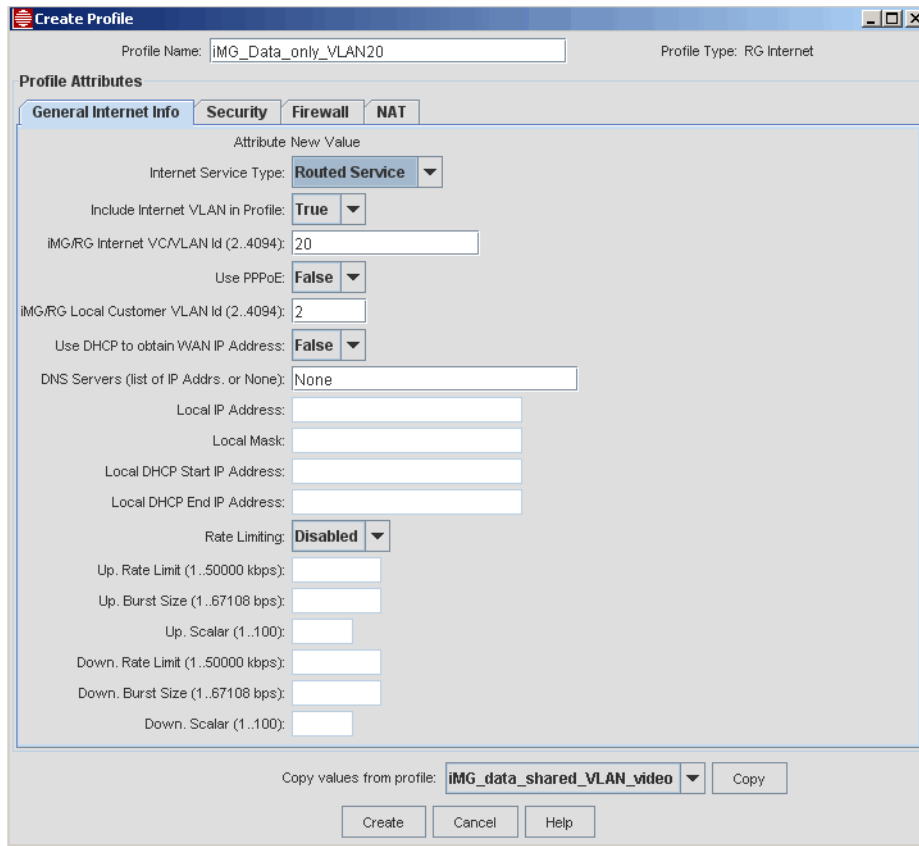

FIGURE 7-174 Internet Form for Multi-service VLAN General Internet Info Tab - Configuration 2

Create Profile

Profile Name: Profile Type: RG Video

Profile Attributes

General Video Info

Attribute	New Value
Include Video VLAN in Profile:	True
iMG/RG Video VC/VLAN ID (2..4094):	10
Use DHCP to obtain WAN IP Address:	
IGMP Mode:	None
Multicast Acceleration:	Disabled
IGMP Timeout (1..65535 seconds):	
IGMP Leave Time:	
IGMP Security:	Enabled
IGMP Security Autolearning:	Enabled
Trusted Host Limit (1..6):	2
IGMP Default Fast Leave:	Enabled

Copy values from profile: VIDEO_MultVC Copy

Create Cancel Help

FIGURE 7-175 Video Form for Multi-service VLAN - Configuration 2

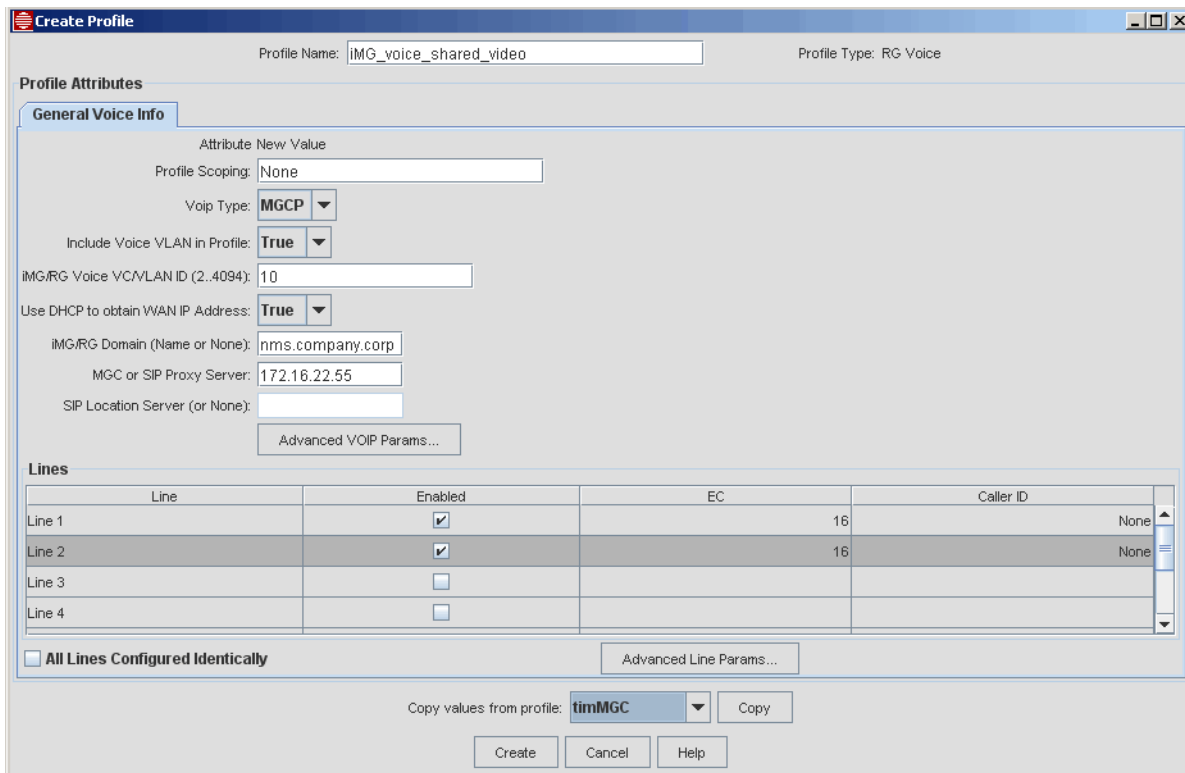

FIGURE 7-176 Voice Form for Multi-service VLAN - Configuration 2

2. Data fill the Triple-Play Form. Since there are three different customers and types of interfaces, the Customer ID for each must be unique, and the slot.Port will be different. (The iMAP could be the same if all of the interface cards were on the same iMAP. Refer to the following table.)

TABLE 7-35 Triple Play Forms for Voice, Video/Data VLAN Configuration

iMG Type	Attributes	Reference
EPON (iMG646PX-ON)		Figure 7-177
FX (iMG646)		Figure 7-178
ADSL (iMG634)		Figure 7-179

The screenshot shows the 'Provision New Triple Play Customer' window for an EPON interface. The description is 'Config2_EPON_interface'. The iMG/RG General Configuration section has 'iMG_one_data_two_video' selected. The Video/Data Configuration section shows 'Access Device' as 10.52.30.35 and 'Slot Port' as 9.0.3. The 'Allowed IP Addr. Ranges' section contains five empty input fields. The 'Data Svcs. Config' section has 'iMG_Data_only_VLAN20' selected. The 'Video Service Config' section has 'iMG_Video_shared_voice' selected. The 'Voice Configuration' section has 'iMG_voice_shared_video' selected. The 'Schedule' section has 'Now' selected. Buttons at the bottom include 'Provision', 'Recent Commands...', 'Close', and 'Help'.

FIGURE 7-177 Triple-Play Form EPON Interface - Configuration 2

The screenshot shows the 'Provision New Triple Play Customer' window for an FX interface. The description is 'Config2_FX_interface'. The iMG/RG General Configuration section has 'iMG_one_data_two_video' selected. The Video/Data Configuration section shows 'Access Device' as 10.52.30.37 and 'Slot Port' as 5.3. The 'Allowed IP Addr. Ranges' section contains six empty input fields. The 'Data Svcs. Config' section has 'iMG_Data_only_VLAN20' selected. The 'Video Service Config' section has 'iMG_Video_shared_voice' selected. The 'Voice Configuration' section has 'iMG_voice_shared_video' selected. The 'Allowed STB MAC Adrs' section contains six empty dropdown menus. The 'Schedule' section has 'Now' selected. Buttons at the bottom include 'Provision', 'Recent Commands...', 'Close', and 'Help'.

FIGURE 7-178 Triple-Play Form FX Interface - Configuration 2

FIGURE 7-179 Triple-Play Form ADSL Interface - Configuration 2

7.10.13.3 Creating a Video and Data/Voice VLAN (Configuration 3)

In this configuration, the Video VLAN is a separate VLAN, and data and voice share a single VLAN. Refer to the following figure and notes in 7.10.13 before performing the procedure.

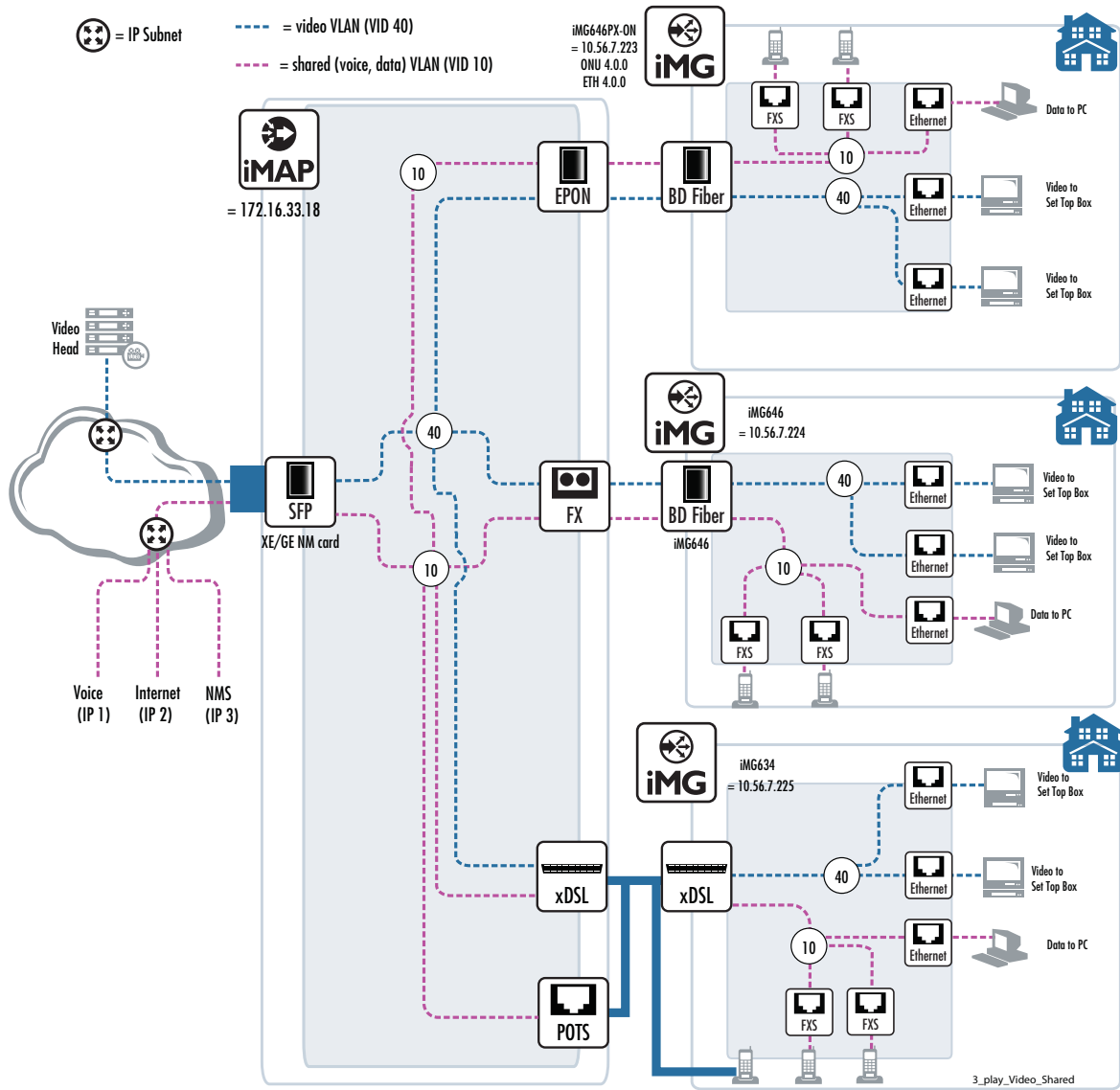

FIGURE 7-180 Multi-service (Data, Voice) VLAN (Configuration 3)

1. Create the appropriate iMG profiles. Refer to the following table and figures.

TABLE 7-36 iMG Forms for Voice, Video/Data VLAN (Configuration) 2

Form	Name	Attributes	Reference
General	iMG_one_data_two_video	Since the port and VLAN configuration is the same for all iMGs, the same General Form is used in all configurations	Figure 7-165 - Mgmt. Info Figure 7-166 - Port Assignment
Internet	iMG_Data_shared_voice		Figure 7-174
Video	iMG_Video_VLAN_40		Figure 7-175
Voice	iMG_Voice_shared_data		Figure 7-176

The screenshot shows the 'Create Profile' window with the following configuration details:

- Profile Name:** iMG_Data_shared_voice
- Profile Type:** RG Internet
- Profile Attributes:**
 - General Internet Info:**
 - Attribute New Value
 - Internet Service Type: Routed Service
 - Include Internet VLAN in Profile: True
 - iMG/RG Internet VLAN Id (2..4094): 10
 - Use PPPoE: False
 - iMG/RG Local Customer VLAN Id (2..4094): 2
 - Use DHCP to obtain WAN IP Address: True
 - DNS Servers (list of IP Adrs. or None): None
 - Local IP Address: [Empty]
 - Local Mask: [Empty]
 - Local DHCP Start IP Address: [Empty]
 - Local DHCP End IP Address: [Empty]
 - Copy values from profile: iMG_Data_only_VLAN20

FIGURE 7-181 Internet Form for Multi-service VLAN General Internet Info Tab - Configuration 3

The screenshot shows a 'Create Profile' window with the following configuration details:

Attribute	New Value
Profile Name	IMG_Video_VLAN_40
Profile Type	RG Video
Include Video VLAN in Profile	True
IMG/RG Video VC/VLAN ID (2..4094)	40
Use DHCP to obtain WAN IP Address	
IGMP Mode	None
Multicast Acceleration	Disabled
IGMP Timeout (1..65535 seconds)	
IGMP Leave Time	
IGMP Security	Enabled
IGMP Security Autolearning	Enabled
Trusted Host Limit (1..6)	2
IGMP Default Fast Leave	Enabled

Copy values from profile: timVIDEO [Copy]

[Create] [Cancel] [Help]

FIGURE 7-182 Video Form for Multi-service VLAN - Configuration 3

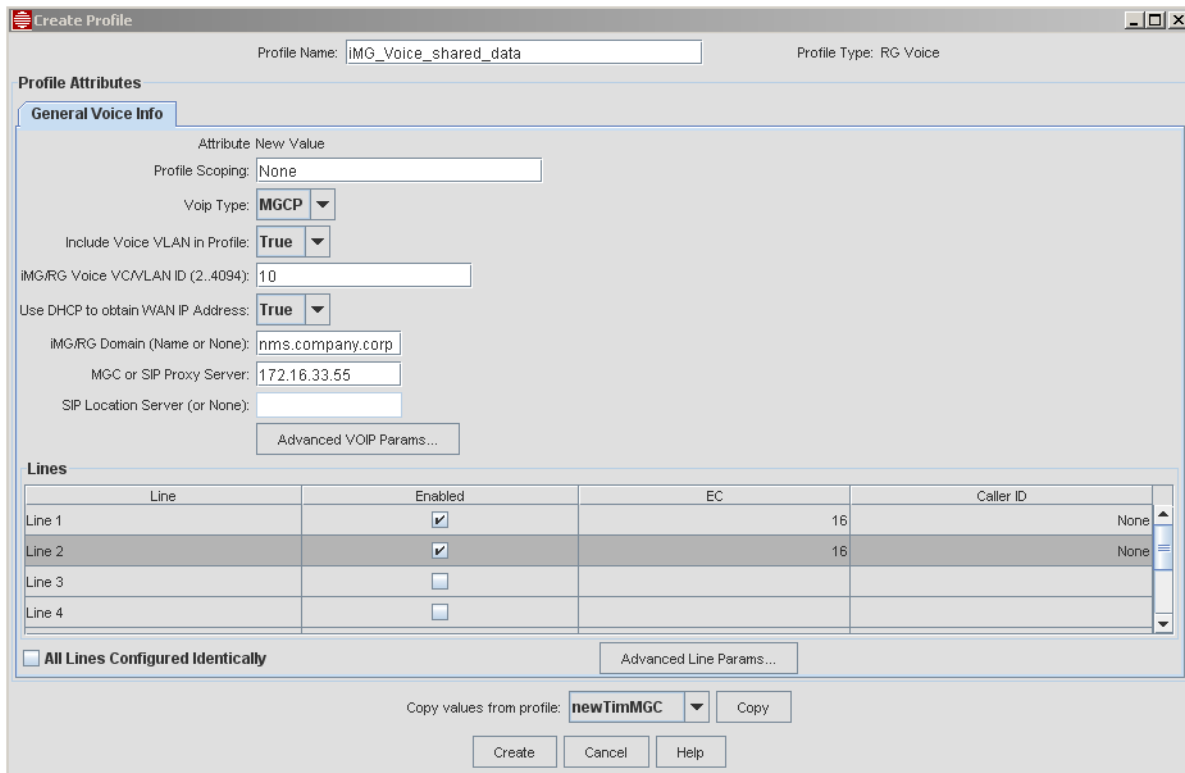

FIGURE 7-183 Voice Form for Multi-service VLAN - Configuration 3

2. Data fill the Triple-Play Form. Since there are three different customers and types of interfaces, the Customer ID for each must be unique, and the slot.Port will be different. (The iMAP could be the same if all of the interface cards were on the same iMAP. Refer to the following table.

TABLE 7-37 Triple Play Forms for Voice, Video/Data VLAN Configuration

iMG Type	Attributes	Reference
EPON (iMG646PX-ON)		Figure 7-184
FX (iMG646)		Figure 7-185
ADSL (iMG634)		Figure 7-186

Provision New Triple Play Customer

Description (Customer ID):

iMG/RG General Configuration

iMG/RG General Profile: iMG/RG MAC Address:

Video/Data Configuration

Access Device: Slot Port: (ONU) ONU MAC Addr.: Port Profile:

Allowed IP Addr. Ranges: IP Addr/# Bits (e.g. 192.4.1.0/24)

Range #1: Range #2: Range #3:
 Range #4: Range #5: Range #6:

Data Svcs. Config: Internet Svc. Profile:

Video Service Config: Video Svc. Profile:

Voice Configuration

Derived Voice: Derived Voice Svc. Profile:

Schedule

Now Hold Schedule:

FIGURE 7-184 Triple-Play Form EPON Interface - Configuration 2

Provision New Triple Play Customer

Description (Customer ID):

iMG/RG General Configuration

iMG/RG General Profile: iMG/RG MAC Address:

Video/Data Configuration

Access Device: Slot Port: (FX) Port Profile:

Allowed IP Addr. Ranges: IP Addr/# Bits (e.g. 192.4.1.0/24)

Range #1: Range #2: Range #3:
 Range #4: Range #5: Range #6:

Data Svcs. Config: Internet Svc. Profile:

Video Service Config: Video Svc. Profile:

Allowed STB MAC Addr:

STB #1: STB #2: STB #3:
 STB #4: STB #5: STB #6:

Voice Configuration

Derived Voice: Derived Voice Svc. Profile:

Schedule

Now Hold Schedule:

FIGURE 7-185 Triple-Play Form FX Interface - Configuration 3

Provision New Triple Play Customer

Description (Customer ID):

iMG/RG General Configuration

iMG/RG General Profile: iMG/RG MAC Address:

Video/Data Configuration

Access Device: Slot Port: (ADSL) Port Profile:

Allowed IP Addr. Ranges: IP Addr/# Bits (e.g. 192.4.1.0/24)

Range #1: Range #2: Range #3:

Range #4: Range #5: Range #6:

Data Svcs. Config: Internet Svc. Profile:

Video Service Config: Video Svc. Profile:

Allowed STB MAC Addr:

STB #1: STB #2: STB #3:

STB #4: STB #5: STB #6:

Voice Configuration

POTS: Access Device: Slot Port: POTS Port Profile:

POTS Call Agent: Unconfigured Line Profile: Interface Group: CRV:

Derived Voice: Derived Voice Svc. Profile:

Schedule

FIGURE 7-186 Triple-Play Form ADSL Interface - Configuration 3

7.11 Provisioning the iMG/RG (no iMAP or AW+)

7.11.1 Overview

Note: Section 7.6.9 provides an overview of provisioning the iMG/RG on AlliedWare Plus (AW+) devices, and how it has the same feature coordination as with iMAPs.

When both the iMG/RG and upstream port are controlled by the NMS, certain provisioning features can be coordinated, allowing the administrator to provision, query, and control one or more iMG/RGs quickly and efficiently.

However, this does not mean the iMG/RG can only be configured by the NMS when it is connected to an iMAP or AW+ port. If the correct steps are taken, the NMS can provision the iMG/RG so that it provides all of its supported services.

When the iMAP and its attributes are not included and are therefore not part of a provisioning/maintaining scenario, the following concepts are altered or not applicable.

- Port Profiles are not part of provisioning.
- DNS Entries for iMAPs (remote IDs) are not included. This is what controls the next item.
- Scoping in the iMG profiles is not part of provisioning.
- The Customer ID applies only to the iMG/RG (and optionally to GenBand).
- In the Triple Play Provisioning window, preferences should be set so that iMAP-related fields do not appear or are masked out.
- Only statistics related to the iMG/RG are displayed in the Triple Play Management window.
- DHCP is still used for provisioning, but the set-up and steps followed are different.
- Since there are no iMAPs in this scenario, the administrator is responsible for all network connections between the iMG/RG, DHCP server, NMS, and service providers. (The network is shown as only a cloud rather than a cloud that includes iMAP interfaces and specific service providers.)

These concepts are explained below.

7.11.2 DHCP Provisioning

7.11.2.1 iMGs/RGs at Release 3-x

As explained in 7.2.5, the iMG/RG, DHCP server, and AlliedView NMS use DHCP to provide provisioning information and to download files until the iMG/RG and its network connections are recognized so that services can be supported. This is still done, as shown in Figure 7-187, but the following is changed.

- Provisioning is tied to the MAC address of the iMG/RG, and must be known before provisioning.
- At the NMS, the RGbootConfigurator must be filled out with TFTP Discovery **Enabled**. When selected, after the RG reboots it sends a DHCP discovery message to the DHCP server (over the RGMgmt VLAN). The iMG/RG then sends a tftp request to the NMS, containing its MAC and IP address. The NMS uses its tftp listener to discover the iMG/RG with this MAC and IP Address. With the IP and MAC Address, the AlliedView NMS can proceed with discovery and provisioning.

Note: With the iMG/RG provisioned with a specific MAC address, the iMG/RG cannot simply be swapped with another one when performing provisioning or maintenance and having the NMS automatically provision the new iMG/RG. At the NMS, the administrator must delete all objects or traces so that the iMG is no longer known to the NMS. You would then start provisioning from the beginning, by knowing the MAC address of the new iMG.

- The dhcpd.conf file must include the NMS IP address.

Refer to Figure 7-187, which shows the steps that are followed

- Pre-provision:
- Fill out MAC Address of the iMG/RG on the Triple Play form
 - RGbootConfigurator set up with Download file with TFTP Enable
 - dhcpd.conf has NMS IP Address

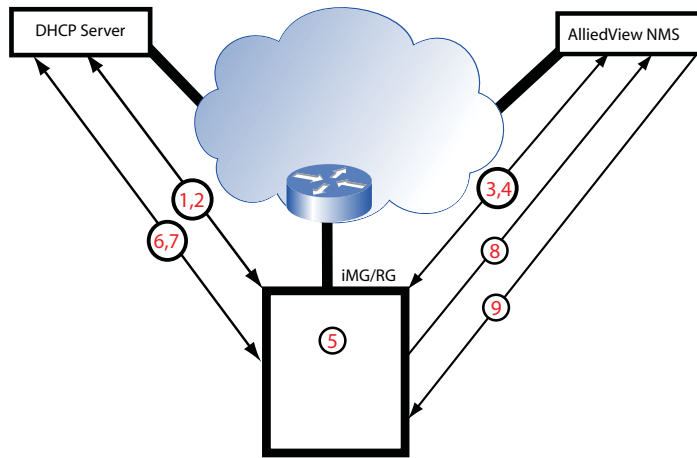

- Step 1** iMG/RG request for Boot IP Address and TFTP Server IP Address
- Step 2** DHCP Server returns information
- Step 3,4** iMG/RG downloads new software and base config file (includes ZTC Enabled and Mgmt VLAN configured)
- Step 5** iMG/RG reboots using new configuration
- Step 6** iMG/RG requests Mgmt IP Address and NMS IP Address (=ZTC Server Address) from DHCP Server
- Step 7** DHCP Server returns information
- Step 8** iMG/RG sends ZTC-like TFTP request to NMS (includes IP and MAC address)
- Step 9** NMS has IP/MAC Address mapping, begins provisioning

FIGURE 7-187 DHCP Provisioning for iMG/RG without an iMAP Interface

Figure 7-188 shows an example from a dhcpd.conf file. The option bootfile-name points to NMS IP address, to which the iMG/RG will send a tftp request.

```
C:\ Select Command Prompt - ssh 10.52.18.79
    match if <substring <option agent.remote-id,0,3>="DOT") and
<substring <option agent.circuit-id,2,2>="\x00\x06") and <option
vendor-class-identifier="RG656BD");
        option vendor-class-identifier "RG656BD";
        filename "ETH";
    }
class "nmsRG613" {
    match if <substring <option agent.remote-id,0,3>="DOT") and
<substring <option agent.circuit-id,2,2>="\x00\x07") and <option
vendor-class-identifier="RG613TX");
        option bootfile-name "10.52.18.68";
    }
class "nmsRG613lh" {
    match if <substring <option agent.remote-id,0,3>="DOT") and
<substring <option agent.circuit-id,2,2>="\x00\x07") and <option
vendor-class-identifier="RG613LH");
        option bootfile-name "10.52.18.68";
    }
class "nmsiMG613rf" {
```

FIGURE 7-188 dhcpd.conf File - Snippet

7.11.2.2 iMGs/RGs at Release 4 and above (NextGen)

As described above, the TFTP Discovery option is used to handle customer provisioning without an iMAP or AlliedWare Plus upstream device and without forwarding DHCP Relay messages to the NMS (option 82).

The iMGs at release 4 and above do not support TFTP discovery, and so the RGbootConfigurator does not have the TFTP Discovery option (tab 4; refer to 7.2.5). DHCP Discovery must be used, with the following rules:

- Ensure the DHCP Server File (dhcpd.conf) has the options associated with the specific VLAN in the DHCP message (refer to 7.2.5.3).
- The upstream devices must be configured to forward DHCP Relay messages to the NMS when it gives out RgMgmt IPs as in section 7.2.5.3.
- Use the vendor-specific option 82 value to define separate classes for the Boot and Mgmt VLANs.
- Configure the Boot class as in section 7.2.5.3.
- Configure the DHCP Mgmt class as in section 7.2.5.3, that is, option bootfile-name is not required.
- Enter the iMG MAC address in the "Provision New Triple Play Customer" dialog, as shown in Figure 7-190.

7.11.3 GUI Provisioning

With the Display Preferences feature (5.6.3), the administrator sees only the fields that are relevant for the provisioning scenario, and fields that need to be filled in are highlighted as the user fills out the fields. In the Display Preferences GUI, there is the iMG/RG Configuration Panel. When selected, the Triple Play form limits the shown fields to only those that are iMG/RG related. Refer to the following figures.

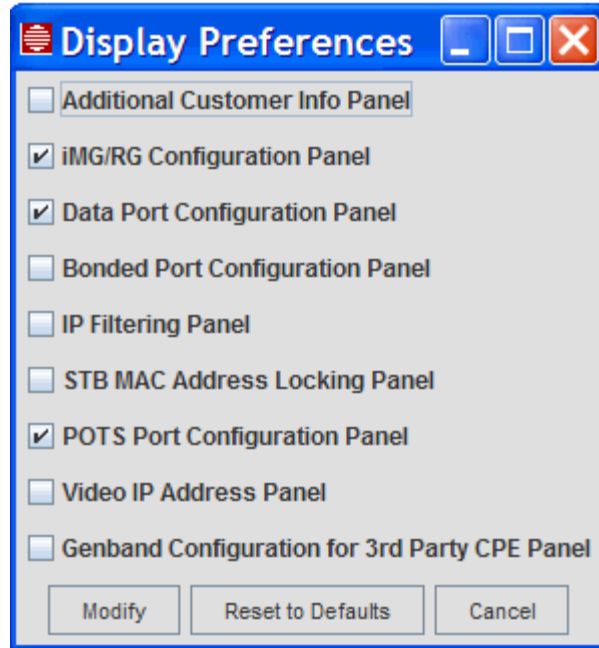

FIGURE 7-189 Display Preferences set for iMG/RG

Provision New Triple Play Customer

Description (Customer ID): Display Preferences

iMG/RG General Configuration

iMG/RG General Profile: iMG/RG MAC Address:

Video/Data Configuration

Data Svcs. Config: Internet Svc. Profile:

Video Service Config: Video Svc. Profile:

CES Service Config: CES Svc. Profile:

Voice Configuration

Derived Voice: Derived Voice Svc. Profile:

SIP Configuration:

Port #8: Number: Login: Password:

Schedule

Now Hold Schedule:

FIGURE 7-190 Triple Play Form without iMAP-related Fields

7.11.4 GUI Displays

Once the iMG/RG is provisioned, the Details Panels are changed as follows:

- There is no Eth/ADSL tab.
- The statistics tab doesn't have PMON or RMON stats
- The graph Stats Tab only lists iMG stats

Refer to the following figure.

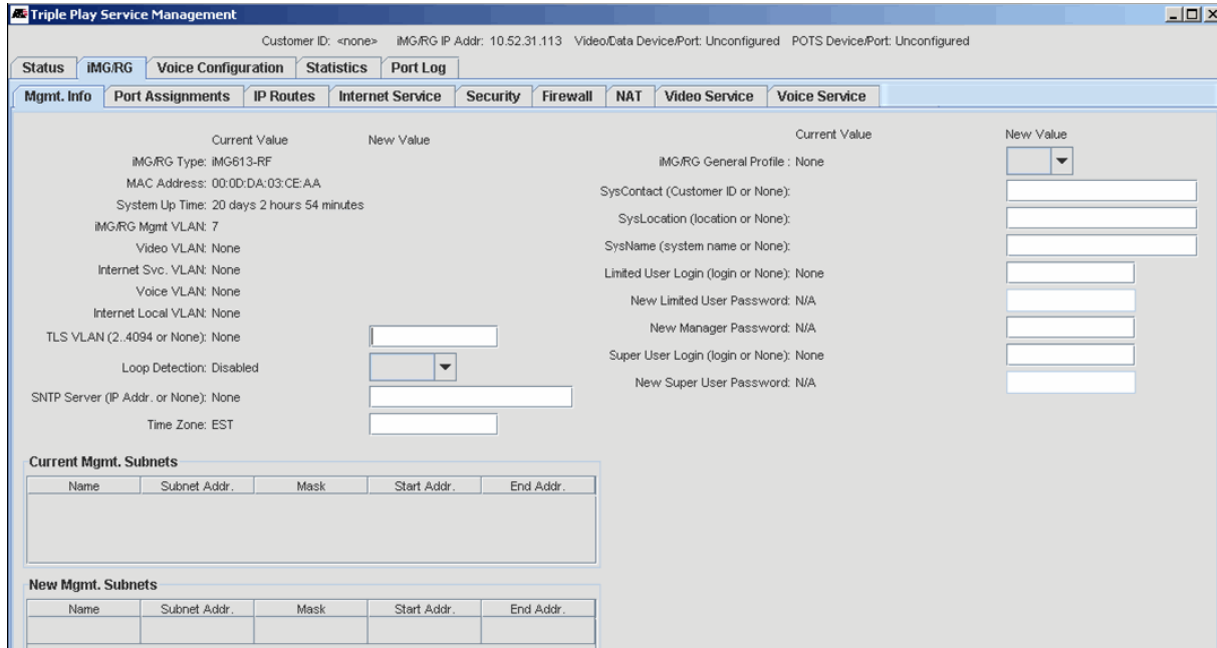

FIGURE 7-191 Service Details Display for iMG/RG without iMAP Interface

7.12 Provisioning an iMG/RG with the LAN4 Feature

7.12.1 Overview

The AlliedView NMS can manage the ADSL iMG 624/634 family over the Ethernet lan4 interface. Moreover, the iMG/RGs must be using the 3-7 release and up. Refer to the following figure.

Note: In this configuration the 624/634 becomes a replacement for the manufacture discontinued iMG-613TX. The new iMG6x4-R2 only supports iMG firmware version 3-7 and up.

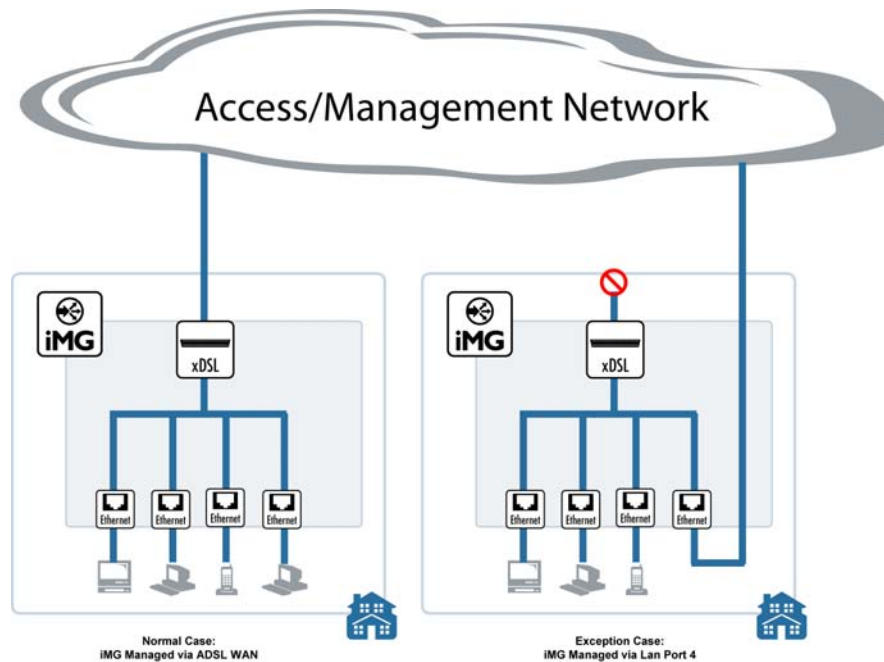

FIGURE 7-192 LAN4 Feature with iMG/RG 624/634 Family Devices

Other than their loss of lan4 port for subscriber services and appropriate changes in the GUIs, the management capabilities are the same. Moreover, this feature works as follows:

- The administrator can data fill profiles so that the NMS automatically determines during installation whether the iMG is managed over the LAN4 or WAN port and correctly configures the device.
- When the LAN4 port is used for the uplink, the ADSL WAN port is disabled. If the user wishes to restore the ADSL WAN port for management, the iMG must be rebooted from the factory configuration.

When an iMG/RG 624/634 is provisioned with LAN4 as the network port, the GUIs on the NMS identify the use of the LAN4 port. This is explained in the following subsections.

7.12.2 Profiles

The iMG/RG Create General Profile wizard has been modified to allow for the selection of “Management” service on the port in addition to the previously supported choices Internet, TLS, Video and Voice. This is a placeholder to ensure the port is not selected for any other service.

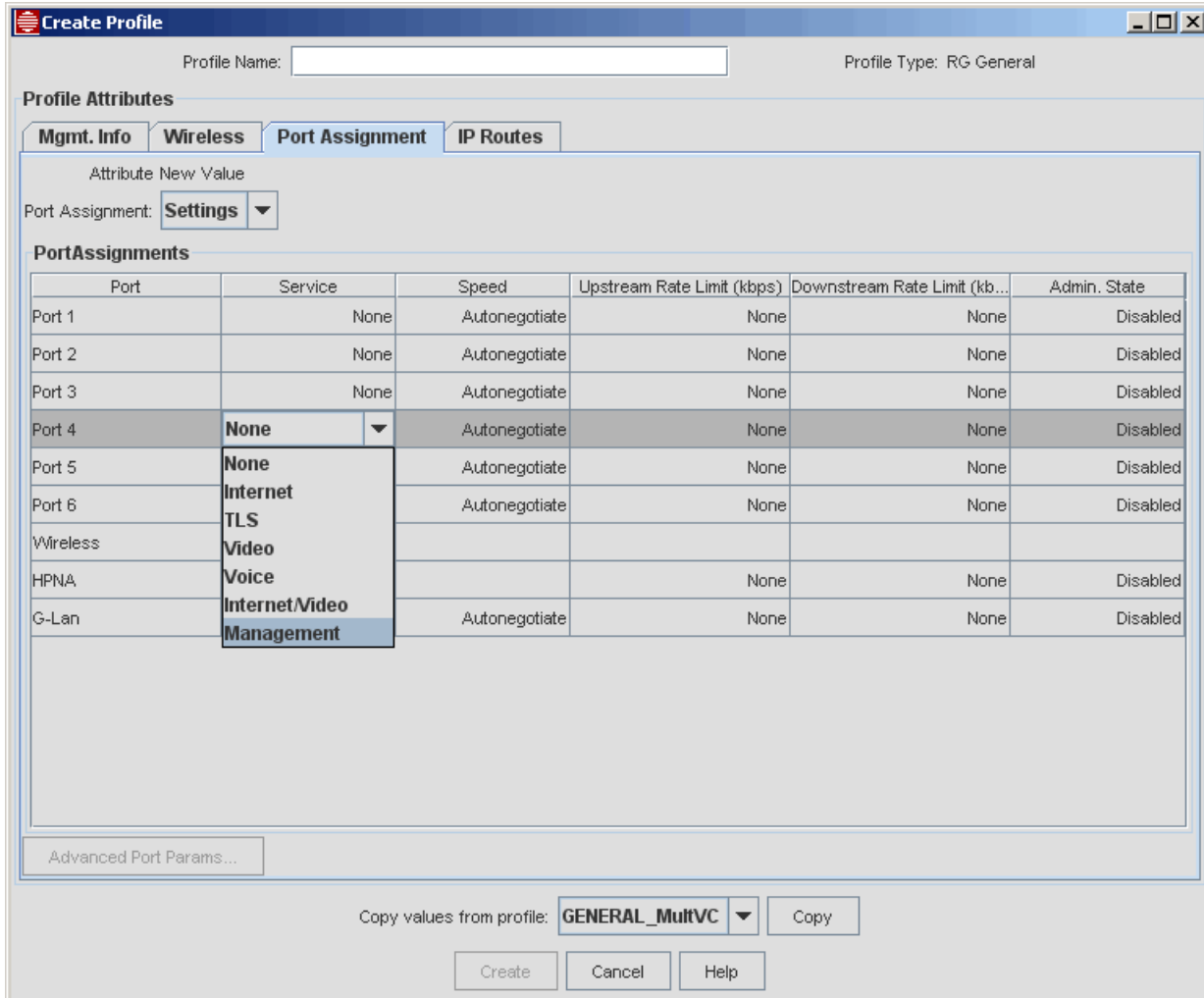

FIGURE 7-193 RG General Profile - Port 4 has Management Option

Also note that once “Management” is selected for a Port in the Create Profile wizard, the Admin State of the node is automatically set to “Enabled” and the user is not allowed to set it to “Disabled” as long as the service is set to “Management”. Refer to the following figure.

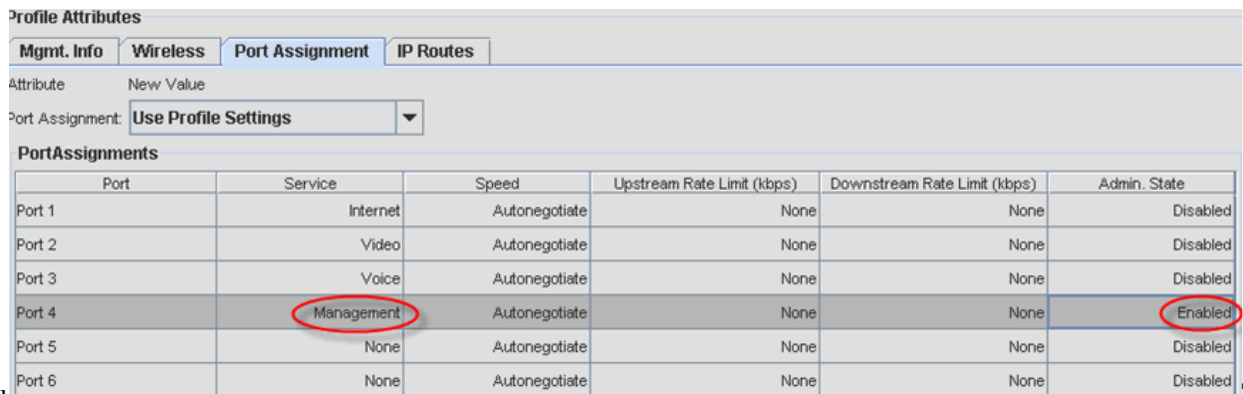

FIGURE 7-194 Port 4 selected for Management - Admin set to Enabled

7.12.3 Service Management GUI

Once the RG is discovered and configured by the NMS, the “Management” service is not used by the system. Once the NMS has discovered the node is managed via LAN 4 it no longer allows the customer to change the port 4 service in the View/Modify wizard. This is accomplished by removing the Port 4 entry in the “Port Assignments” table of the iMG/RG, as shown in the following figure.

Customer ID: KLL_Lan4_634 iMG/RG IP Addr: 10.52.31.106 Video/Data Device: 10.52.30.35 Port: 11.5 POTS Device/Port: Unconfigured

Status **iMG/RG** Ether-like Configuration Voice Configuration Statistics Port Log

Mgmt. Info **Port Assignments** IP Routes Internet Service Security Firewall NAT Video Service Voice Service

Current Port Assignments

Port	Service	Speed	Upstream Rate Limit (kbps)	Downstream Rate Limit (kbps)	Admin. State
Port 1	Internet	Autonegotiate	None	None	Enabled
Port 2	Video	Autonegotiate	None	None	Enabled
Port 3	Internet	Autonegotiate	None	None	Enabled

Port 4 is not displayed when the iMG/RG is LAN managed.

New Port Assignments

Port	Service	Speed	Upstream Rate Limit (kbps)	Downstream Rate Limit (kbps)	Admin. State
Port 1	Internet	Autonegotiate	None	None	Enabled
Port 2	Video	Autonegotiate	None	None	Enabled
Port 3	Internet	Autonegotiate	None	None	Enabled

FIGURE 7-195 Once Configured, LAN4 is not Available

7.12.4 Custom View

The user will have the ability to set up a custom view to show which iMG is running on ADSL vs. LAN 4. This is done by right clicking on the iMG/RGs entry in the Network Inventory, and selecting *Custom Views* -> *Add Custom View*. In the Custom View wizard under the “Properties” tab, choose the “Select Props To View” button, as shown in the following figure.

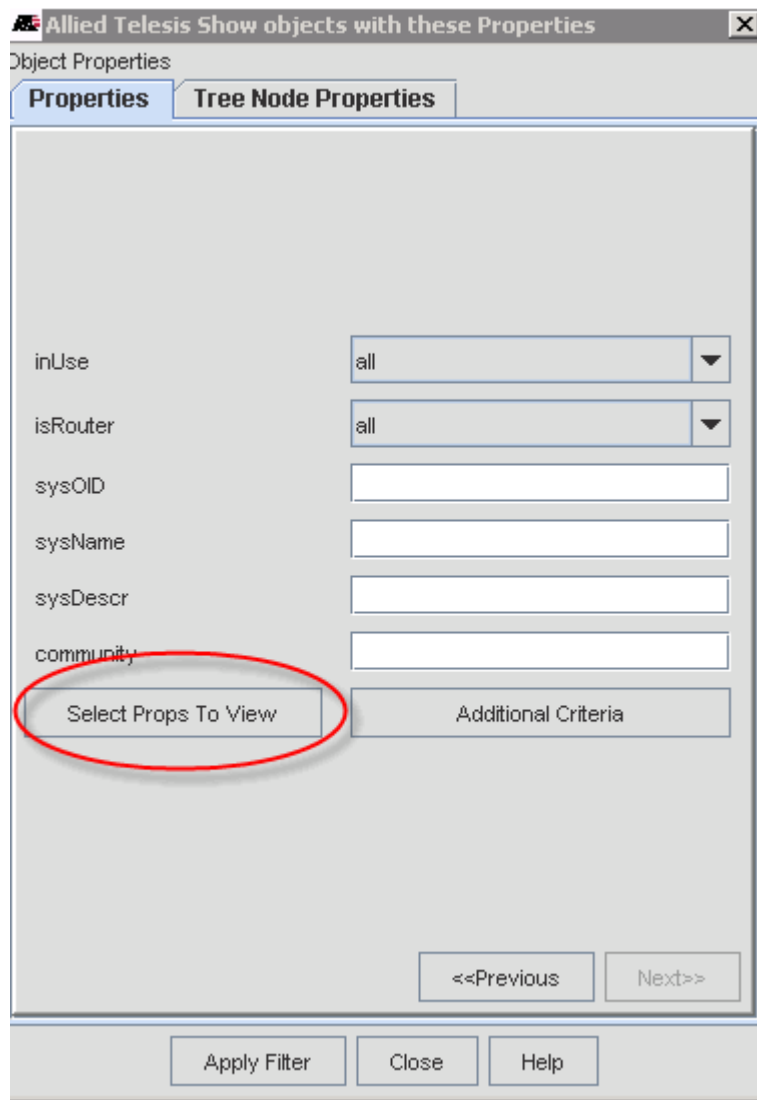

FIGURE 7-196 Selecting Properties for a Custom View

In the next frame that opens select the "Additional table Columns" button, as shown in the following figure.

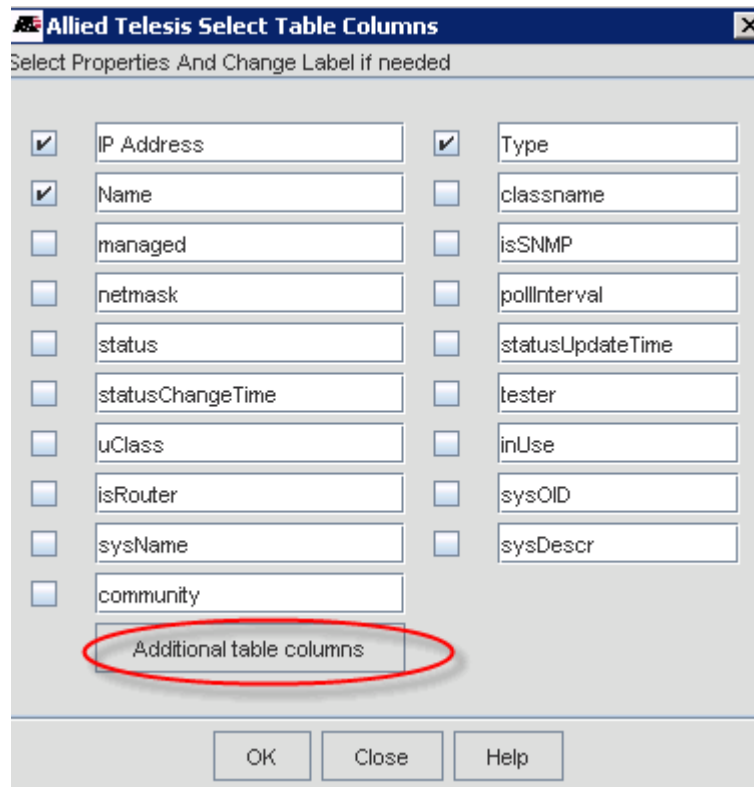

FIGURE 7-197 Selecting Additional Table Columns

From here additional properties that are in the database can be entered and labeled. In our case the property we need to enter is “adsLinkConnected”, the label chosen for this example is “Adsl Mgmt”, indicating whether the iMG/RG is managed via an ADSL port. Refer to the following figure.

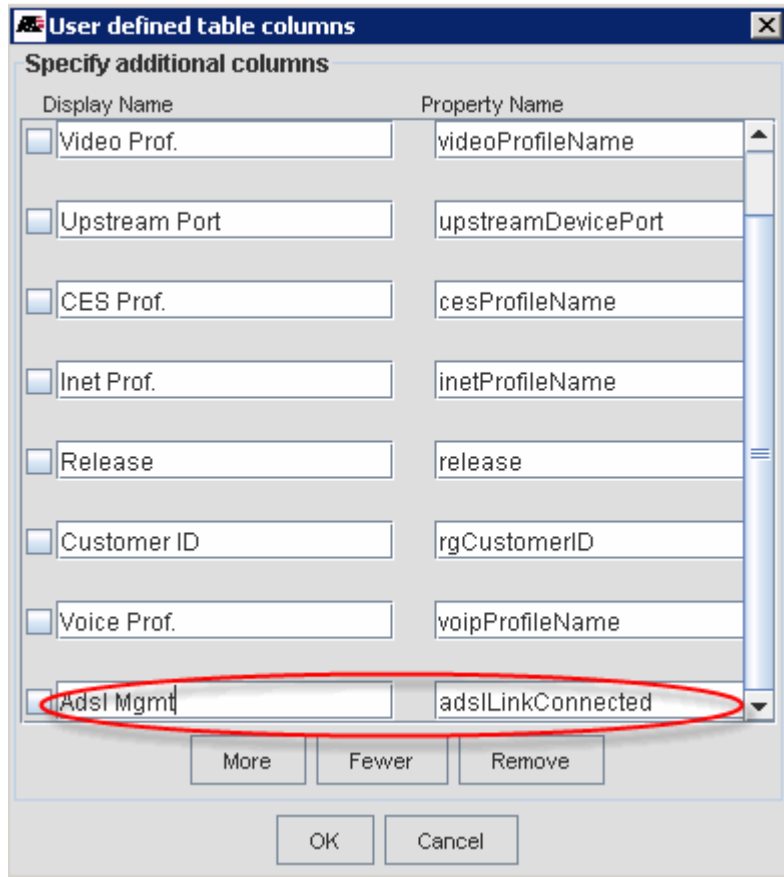

FIGURE 7-198 Adding AdslMgmt Column

The end result of apply this custom view is shown below. The top two RGs show an ADSL managed 634B-R2 box and a LAN4 managed 634B-R2 device, as shown in the following figure.

Customer ID	Adsl Mgmt	IP Address	Type	Name	Release	C
POP_Adsl_634	true	10.52.31.112	IMG634-B-R2	RG_12...	3.7.0-148	X
KLL_Lan4_634	false	10.52.31.106	IMG634-B-R2	RG_12...	3.7.0-148	M
	false	10.52.31.105	IMG634-A	RG_12...	3.7.0-150	
John Jones	true	10.52.31.198	IMG634-WA	RG_12...	3.7.0-150	
Ranger	true	10.52.31.219	IMG624-A	RG_12...	3.7.0-150	

FIGURE 7-199 ADSL Mgmt Column as False if has LAN4 Mgmt

7.12.5 Procedure - Initial Installation of iMG with LAN4

In the following procedure, an iMG634B is pre-provisioned at the NMS; the customer then connects the LAN4 port as the uplink and then powers up the iMG.

7.12.5.1 Pre-provision the NMS

1. Ensure the correct firmware and bootstrap files available and are loaded using the Boot Load configurator. The following figure shows how the configurator should be datafilled.

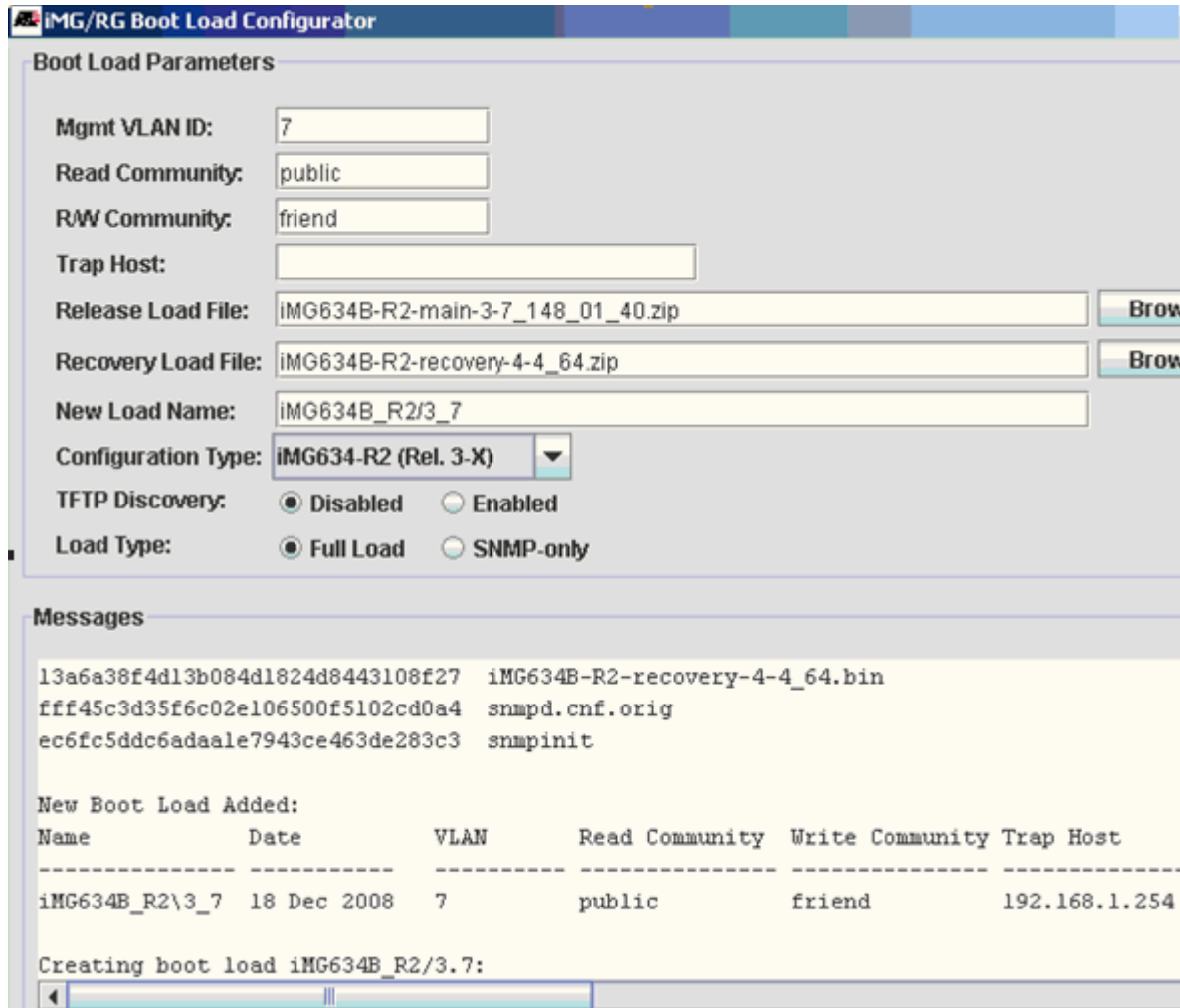

FIGURE 7-200 Boot Configurator for 3-7 Device

2. If not already created, create the relevant profiles that are needed. The only difference between these profiles and the ones for an ADSL uplink is the Port Assignment tab, as shown in Figure 7-194.
3. Use the Triple-Play form and provision the customer, using the profiles create in Step 2. The uplink port is an FE. Refer to the following figure.

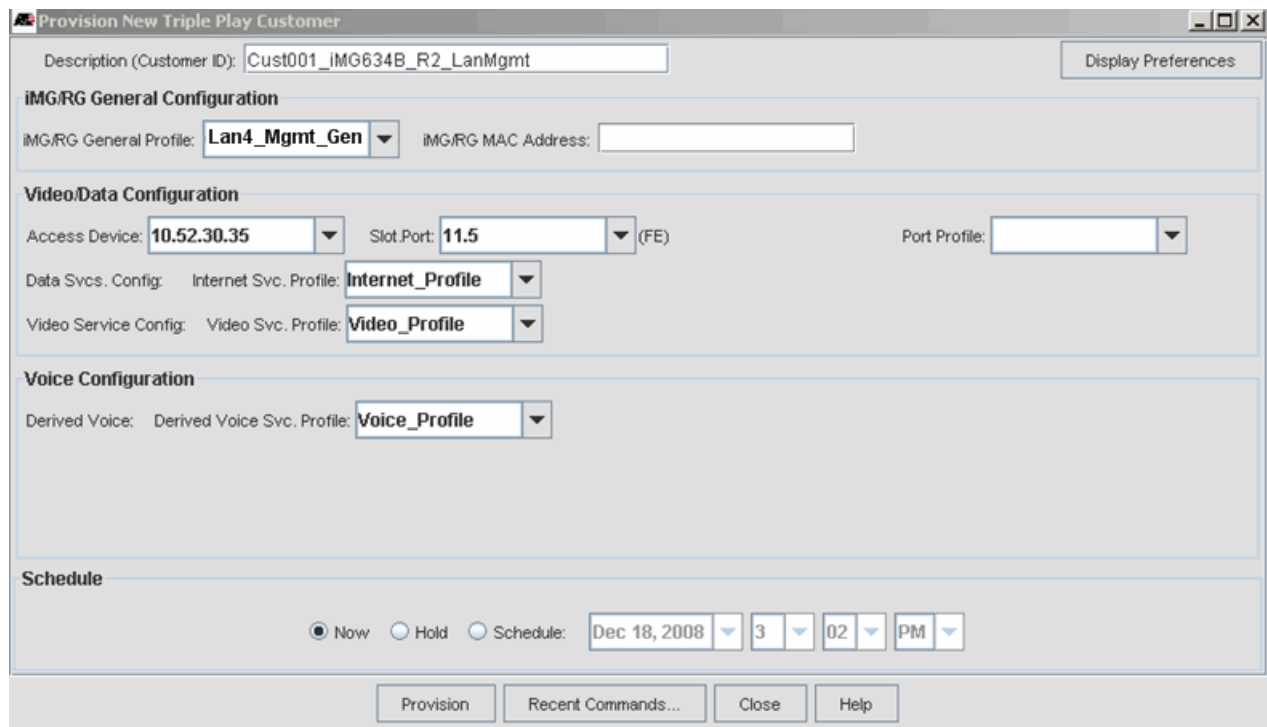

FIGURE 7-201 Triple-Play form Using General Profile for LAN4

- Review the iMG/RG table. Note that there are still no associated profiles and no IP address, as shown in the following figure.

Customer ID	IP Address	Type	Release	Upstream Port	Name	Gen Prof.	Inet Prof.	Video Prof.
	10.52.31.40	IMG613-RF	3.7.1-14	10.52.30.35_5,6	RG_1229439066830			
	10.52.31.24	RG613-LH	3.7.1-14	10.52.30.35_5,4	RG_1229439096549			
	10.52.31.125	RG656-BD	2.5.0-55	10.52.30.35_5,3	RG_1229439627124			
	10.52.31.23	IMG646-MOD	3.6.0-104		RG_1229614022346			
Cust001_iMG634B_R2_LanMgmt	0.0.0.0	RG600Family		10.52.30.35_11,5	RG_1229630331695			
Cust002	10.52.31.185	IMG646-BD	2.5.0-55	10.52.30.35_5,5	RG_1229439540515			
Cust004	10.52.31.171	RG613-TX	2.5.0-55	10.52.30.35_11,1	RG_1229439574390			

FIGURE 7-202 iMG Pre-provisioned

7.12.5.2 Connect the iMG and Power On

- Connect the customer equipment to one or more LAN ports 1, 2, and 3.
- Plug the ethernet uplink into LAN4.
- Power on the iMG.
- Wait and observe how the iMG is discovered, an IP address is found, and the profiles are applied. Refer to the following figure.

Provisioning an iMG/RG with the LAN4 Feature Procedure - Initial Installation of iMG with LAN4

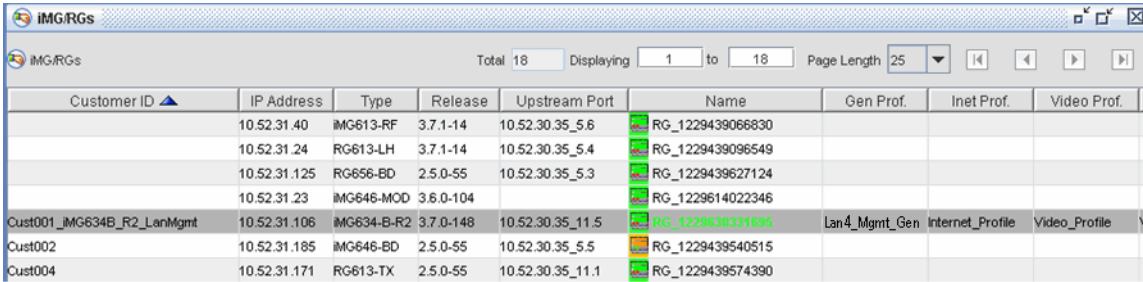

Customer ID	IP Address	Type	Release	Upstream Port	Name	Gen Prof.	Inet Prof.	Video Prof.
	10.52.31.40	iMG613-RF	3.7.1-14	10.52.30.35_5_6	RG_1229439066830			
	10.52.31.24	RG613-LH	3.7.1-14	10.52.30.35_5_4	RG_1229439096549			
	10.52.31.125	RG656-BD	2.5.0-55	10.52.30.35_5_3	RG_1229439627124			
	10.52.31.23	iMG646-MOD	3.6.0-104		RG_1229614022346			
Cust001_iMG634B_R2_LanMgmt	10.52.31.106	iMG634-B-R2	3.7.0-148	10.52.30.35_11.5	RG_1229630331695	Lan4_Mgmt_Gen	Internet_Profile	Video_Profile
Cust002	10.52.31.185	iMG646-BD	2.5.0-55	10.52.30.35_5_5	RG_1229439540515			
Cust004	10.52.31.171	RG613-TX	2.5.0-55	10.52.30.35_11.1	RG_1229439574390			

FIGURE 7-203 iMG Provisioned using LAN4

9. The tabs for the Details screen are the same as an ADSL uplink, with the one difference the Port Assignments tab has no port 4, as shown in Figure 7-195.

7.12.6 Deprovision the iMG and Re-provision with the ADSL Uplink

In this procedure, the iMG that currently uses LAN4 for the uplink is de-provisioned and then re-provisioned using the ADSL port as the uplink.

7.12.6.1 Deprovision the iMG with the LAN4 Uplink

1. Right click on the iMG and select **De-provision Customer iMG/RG**. Select all of the options, as shown in the following figure.

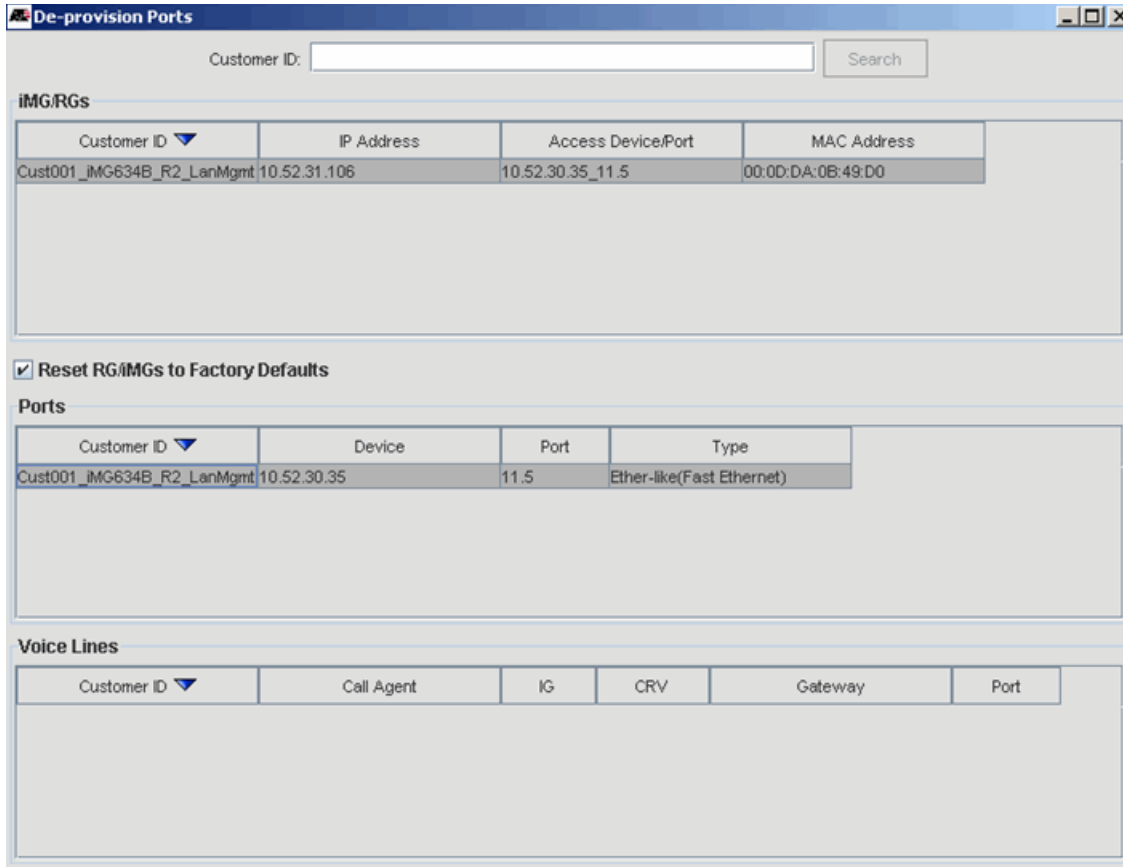

FIGURE 7-204 Deprovision iMG - Reset to Factory Defaults

2. Note in the iMG/RG list that the device has all of the profiles dropped and the IP address is appended with _OLD, since the IP address is now released. Refer to the following figure.

The screenshot shows the 'iMG/RGs' table in the NMS interface. The table has columns: Customer ID, IP Address, Type, Release, Upstream Port, Name, Gen Prof., Inet Prof., and Video Prof. The table contains 18 rows. The first row shows 'Cust001' with IP '10.52.31.40' and Type 'iMG613-RF'. The second row shows 'Cust001' with IP '10.52.31.24' and Type 'RG613-LH'. The third row shows 'Cust001' with IP '10.52.31.125' and Type 'RG656-BD'. The fourth row shows 'Cust001' with IP '10.52.31.23' and Type 'iMG646-MOD'. The fifth row shows 'Cust001' with IP '10.52.31.106_OLD_1' and Type 'iMG634-B-R2'. The sixth row shows 'Cust002' with IP '10.52.31.185' and Type 'iMG646-BD'. The seventh row shows 'Cust004' with IP '10.52.31.171' and Type 'RG613-TX'.

FIGURE 7-205 iMG De provisioned

7.12.6.2 Pre-provision the iMG for ADSL Management

- If not done already, create profiles for the iMG. If the service/VLAN configuration is the same, the only profile that is different is the General Profile, with the Port Assignments tab having port 4 **not** set to Management.
- Fill in the Triple Play Form with the profiles, and select an ADSL port for the Slot.Port, as shown in the following figure.

FIGURE 7-206 Triple Play for ADSL Mgmt

7.12.6.3 Connect the iMG and Power On

- Connect the customer equipment to one or more LAN ports 1, 2, 3, and 4.
- Plug the uplink ADSL into the ADSL port.
- Power on the iMG.
- Wait and observe how the iMG is discovered, an IP address is found, and the profiles are applied. Refer to the following figure.

Customer ID	IP Address	Type	Release	Upstream Port	Name	Gen Prof.	Inet Prof.	Video Prof.
	10.52.31.40	iMG613-RF	3.7.1-14	10.52.30.35_5.6	RG_1229439066830			
	10.52.31.24	RG613-LH	3.7.1-14	10.52.30.35_5.4	RG_1229439096549			
	10.52.31.125	RG656-BD	2.5.0-55	10.52.30.35_5.3	RG_1229439627124			
	10.52.31.23	iMG646-MOD	3.6.0-104		RG_1229614022346			
	10.52.31.106_OLD_1	iMG634-B-R2	3.7.0-148	10.52.30.35_11.5	RG_1229630331695			
Cust002	10.52.31.185	iMG646-BD	2.5.0-55	10.52.30.35_5.5	RG_1229439540515			
Cust002_IMG634B_R2_ADSL	10.52.31.106	iMG634-B-R2	3.7.0-148	10.52.30.35_8.0	RG_1229631671796	General_Profile	Internet_Profile	Video_Profile

FIGURE 7-207 iMG Provisioned using ADSL (no longer LAN4)

- Note that in the Customer Details form, the Port Assignments tab now has port 4.

7.13 LCFO

The Loop Current Feed Open option is used to indicate that the calling/called party has gone onhook and is a useful feature for businesses that have key systems that transfer calls. This is available on all iMGs that are 3-7 and up. Both MGCP and SIP are supported.

Attribute	Current Value	New Value
Voip Provider Interface:	MGCP	
iMG/RG MGCP Profile:	Genband	
iMG/RG MGCP Piggy-back:	Enabled	
LCFO:	Enabled	Enabled
Port Range (1026..65532/2..32):	50600/32	
Packet Length (msec):	20	
RTPCP:	OFF	
RTP Session Time-out (0..1440 min.):	0	
iMG/RG Admin. Profile:		
E.164 Country Code (code or None):		
International Call Prefix (prefix or None):		
SIP Authentication:		
SIP Registration Ring Splash:		
SIP Subscriber Event Message Summary:		
DTMF Relay Mode:	Auto	

Done Clear Entry Fields

FIGURE 7-208 Advanced VOIP Attributes (MGCP) - LCFO

Attribute	Current Value	New Value
Voip Provider Interface:	SIP	SIP
iMG/RG MGCP Profile:		
iMG/RG MGCP Piggy-back:		
LCFO:	Enabled	
Port Range (1026..65532/2..32):	50600/32	
Packet Length (msec):	20	
RTCP:	OFF	
RTP Session Time-out (0..1440 min.):	0	
iMG/RG Admin. Profile:	None	
E.164 Country Code (code or None):	None	
International Call Prefix (prefix or None):	None	
SIP Authentication:	proxy,www	
SIP Registration Ring Splash:	Disabled	
SIP Subscriber Event Message Summary:	Disabled	
DTMF Relay Mode:	Auto	

Done Clear Entry Fields

FIGURE 7-209 Advanced VOIP Attributes (SIP) - LCFO

The LCFO option is also displayed from the “Advanced VOIP Params...” button that is on both the Port Management View/Modify “Voice Service” tab, and the iMG/RG Voice Service Profile display.

Note: When LCFO is enabled, it applies to all VoIP lines on the iMG/RG.

7.14 iMG/RG Diagnostic Features

This section lists and describes the diagnostic features that are available for the various iMG/RG models.

7.14.1 iMG GR909 Diagnostics

In the MOD iMGs and the iMG726-BD-ON, the GR909 diagnostic feature was added in release 3.7.4. In NMS release 12.0, the NMS supports this GR-909 diagnostic functionality. With the NMS, the user can view and modify voice enabled lines on a CPE. The user can control voice line operation state and conduct internal and external voice diagnostics. Changes to the GUI tab are:

- A VOIP Diagnostics tab has been added to the iMG/RG panel.
- The VOIP Diagnostics panel displays GR909 internal and external tests as well as voice line status and diagnostic results.
- Voice lines can be disabled and enabled.

The VOIP Diagnostics panel is added to the Triple Play View/Modify suite of tabbed panels. VOIP Diagnostics belongs to the iMG/RG Diagnostics sub-tab and is **only** displayed for iMG6x6MOD and iMG7x6MOD CPE. Refer to the following figure.

Note: This tab is not available for any other type of CPE

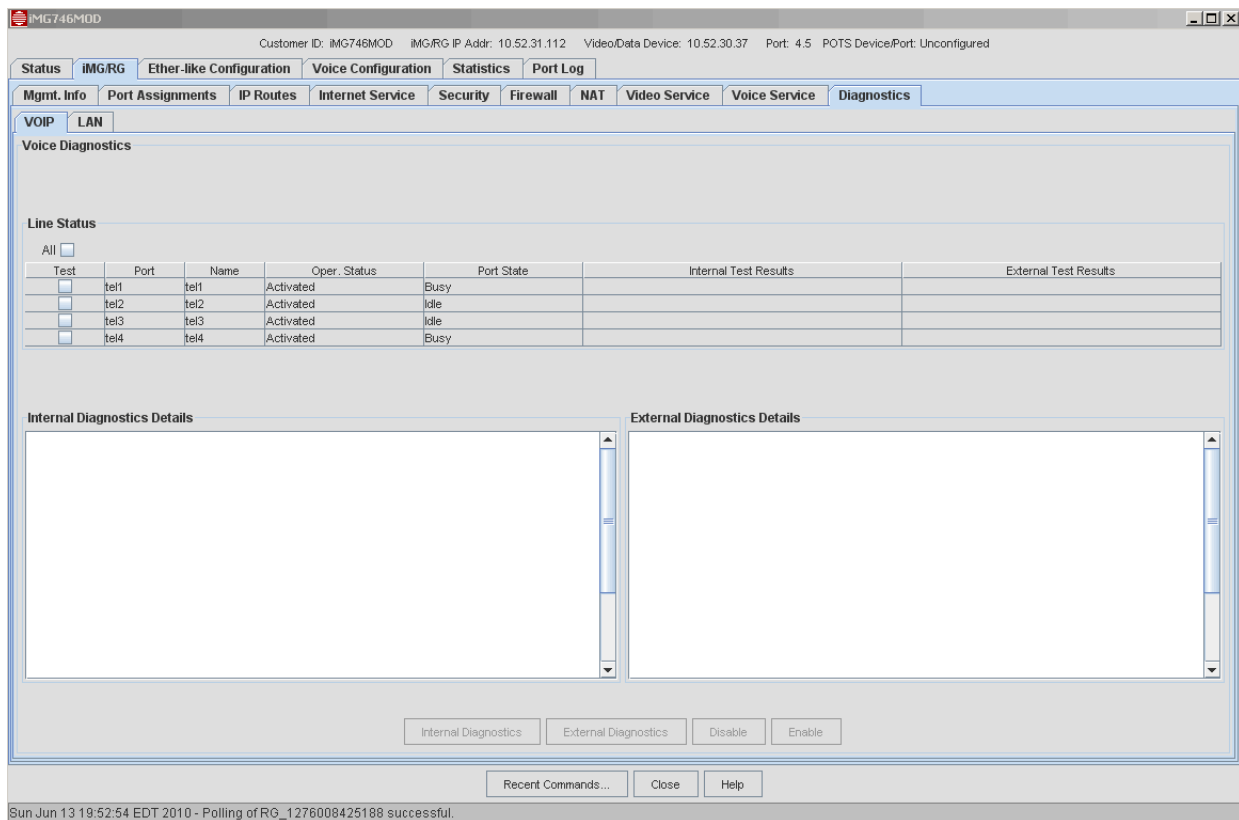

FIGURE 7-210 VOIP Diagnostics Tab

Initially the table displays each enabled voice port on the iMG and its current status. The current status consists of:

- Port
- Name
- Operational Status (Activated/Deactivated)

- Port State

These are polled from the device and updated approximately every 30 seconds while the tab is displayed.

Each line has an internal and external test results field. When a row is selected, the last diagnostic results are displayed in the details panels. The Test check box selects lines that the buttons will perform actions against. All lines may be checked at once, using the “All” check box, and an operation such as Disable will attempt to disable all lines.

Note: Note: Testing all interfaces at once will increase the duration of the test and will interrupt CPE voice service.

Since diagnosing voice lines can interrupt service, there is the following user confirmation:

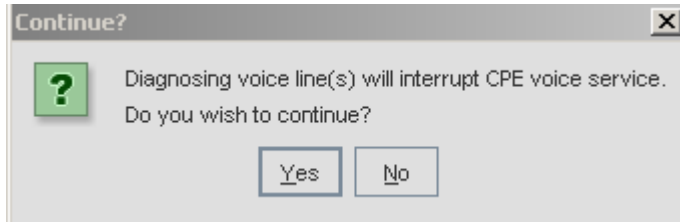

FIGURE 7-211 Warning when Diagnosing VOIP Lines

The results of tests are displayed in the details panels, as shown in the following figure.

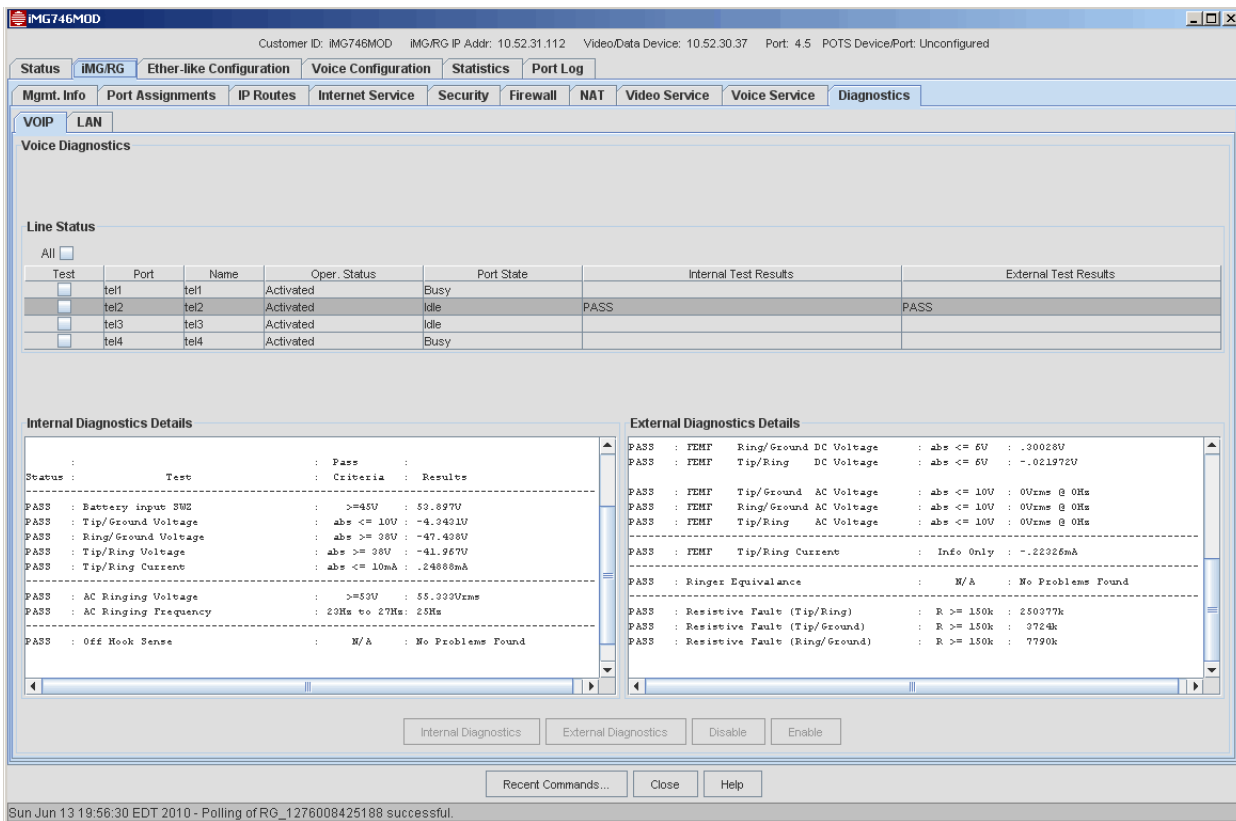

FIGURE 7-212 GR909 Test Results

7.14.2 iMG LAN Diagnostics

In the MOD iMGs and the iMG726-BD-ON, the LAN diagnostic feature was added in release 3.7.4. In NMS release 12.0, the NMS supports this LAN diagnostic functionality. With the NMS, the user can diagnose CPE LAN ports. This diagnosis will detect faults in the subscriber's private network cables. The change to the GUI is a new panel that allows the user to select any or all CPE switch ports, diagnose them, and see the results

The LAN Diagnostics Panel is added to the Triple-Play Service Management Form for the iMG. The LAN Diagnostics belongs to the iMG/RG Diagnostics sub-tab, but it is only displayed if the iMG/RG is an iMG6x6MOD or iMG7x6MOD CPE. Refer to the following figure.

Note: This tab is only available for the MOD-type iMG.

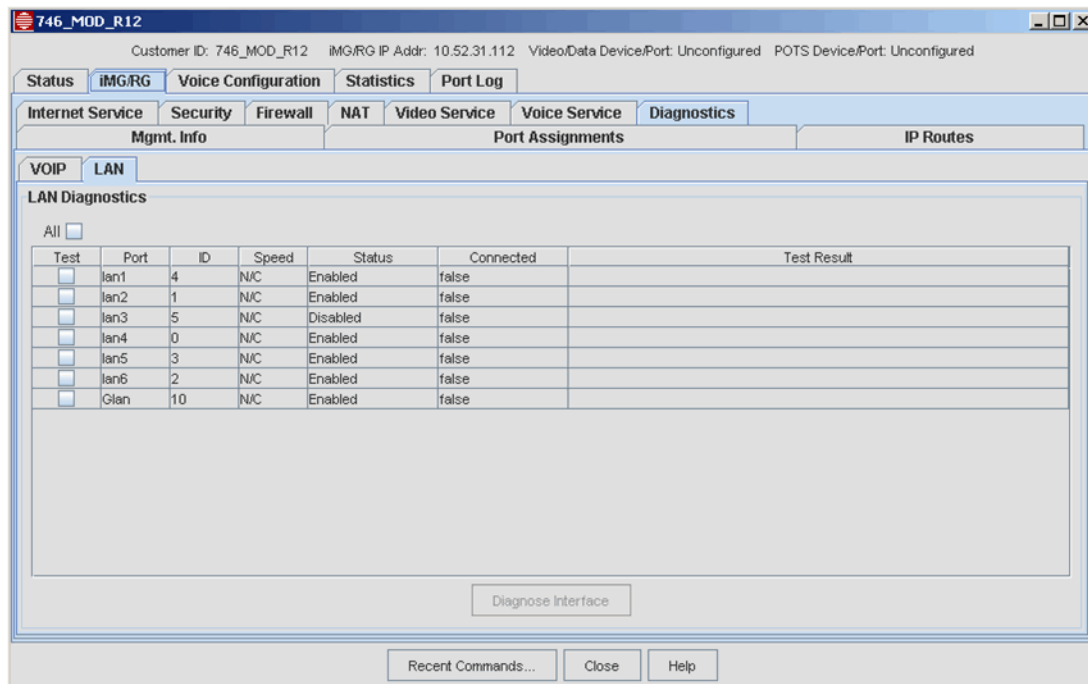

FIGURE 7-213 LAN Diagnostics Tab for MOD-type iMG

Initially the table displays each LAN port on the iMG and its current status.

Not all modules include a Glan interface; if the Glan interface is not present, the Glan row will be omitted from the table.

The current status consists of ID, Speed, Status (enabled/disabled), and Connected (true/false). These are polled from the device and updated approximately every 30 seconds while the tab is displayed.

With each port is a “Test” button and a “Test Result” field. The Test buttons can be checked or unchecked to select individual ports for diagnosis. The “All” button is a shortcut to conveniently check or uncheck all interfaces.

The selected ports will be diagnosed when the “Diagnose Interface” button at the bottom of the panel is activated. The operation will take several seconds.

Note: Testing all interfaces at once will increase the duration of the test and possibly interrupt CPE LAN service, so normally test one interface at a time or small groups at a time rather than all interfaces at one time.

Since CPE LAN service may be interrupted during diagnosis, user confirmation is required before the operation will be performed, as shown in the following figure.

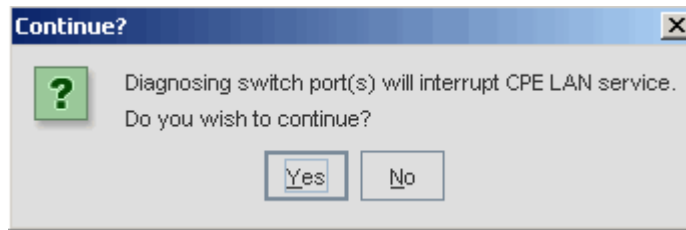

FIGURE 7-214 Warning when Diagnosing LAN Ports

While diagnosis is underway, the test results display “Working” as shown below.

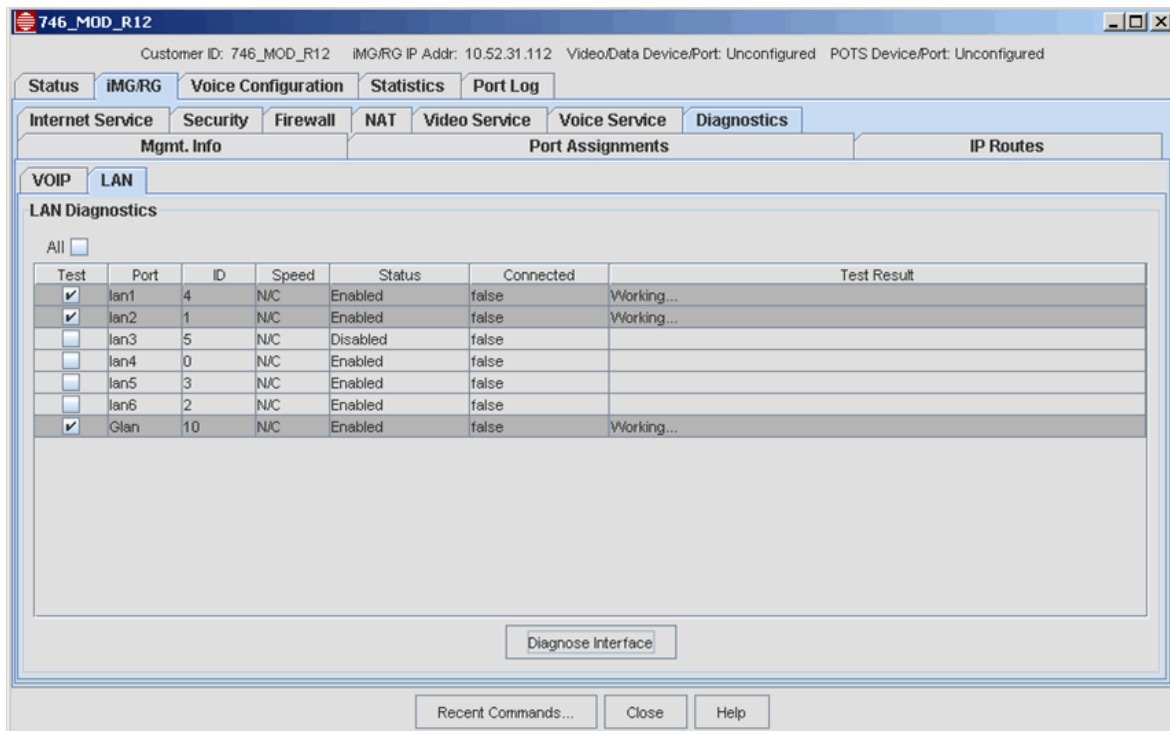

FIGURE 7-215 LAN Port Diagnostics in Progress

When completed, the results for each interface will be displayed in the Test Result field. Notice the Glan interface, when present, will contain an additional Tx/Rx pair.

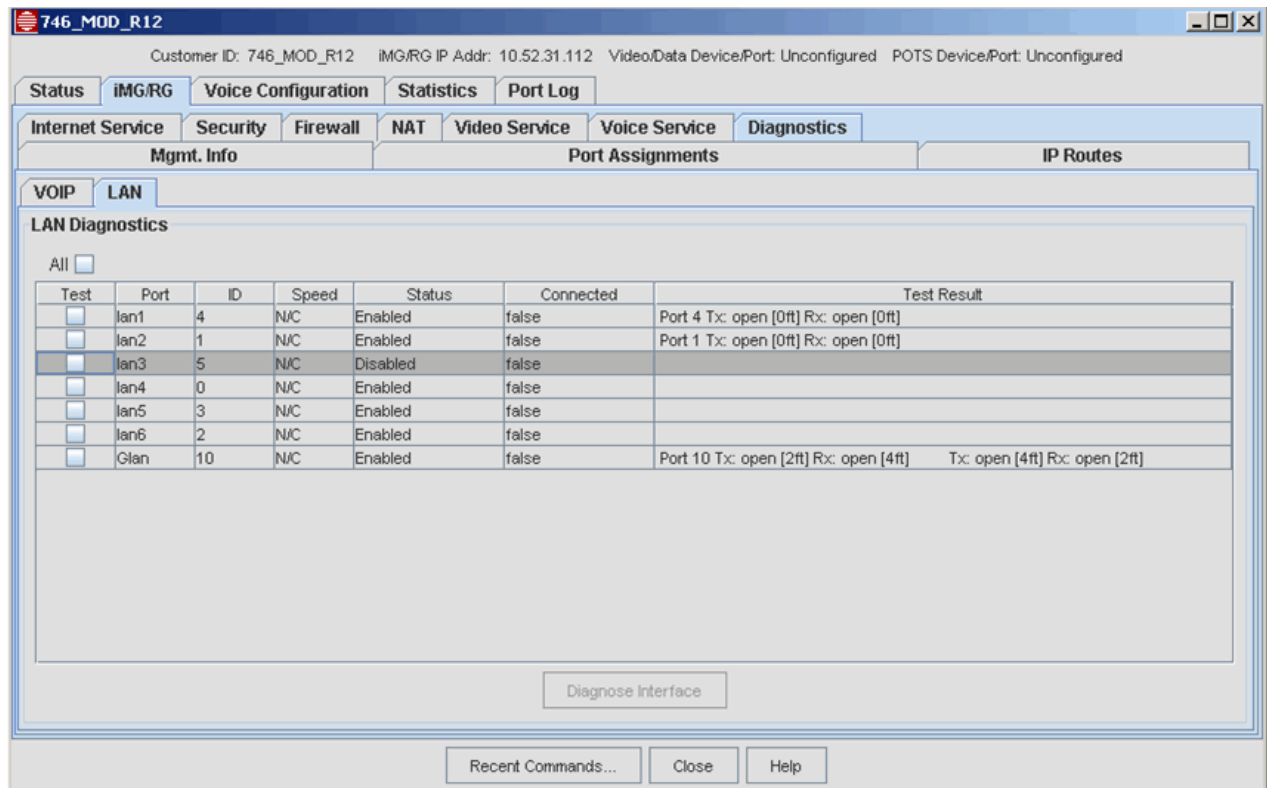

FIGURE 7-216 LAN Port Diagnostics Complete

For more information on these tests refer to the *ATI Gateway Product Family Software Reference Manual*.

7.15 System Power Management

This feature allows the user to modify power management for the device. When enabled at the device level, specified ports immediately shut down, usually so that services such as lifeline POTS can continue as long as possible on battery backup. When disabled, battery power traps are not sent from the device and port-based power management settings will have no effect.

The table below shows iMG devices running 3.8 indicating which types support the ability to configure system power management or whether the device can display port state for LAN and voice ports.

TABLE 7-38 iMG/RG Power Management Feature and Port State Support

Device Type	System Power Mgmt	LAN Port Power Mgmt	LAN Port State	TEL Ports Power Mgmt	TEL Ports State
RG613-BD/LH	Y				
iMG613-RF	Y				
RG656-BD	Y	Y	Y	Y	Y
iMG606-BD/LH/SH	Y	Y	Y	Y	Y
iMG606-BD-R2	Y	Y	Y	Y	Y
iMG646-BD/LH/SH	Y	Y	Y	Y	Y
iMG646-BD-ON/PX-ON	Y	Y	Y	Y	Y
iMG616-BD/LH/SH	Y				
iMG616-BD-R2	Y				
iMG616-RF/RF+	Y				
iMG616-SRF+	Y				
iMG616-W	Y	Y	Y	Y	Y
iMG626-MOD	Y	Y	Y	Y	Y
iMG646-MOD	Y	Y	Y	Y	Y
iMG726-MOD	Y	Y	Y	Y	Y
iMG746-MOD	Y	Y	Y	Y	Y
iMG726-BD-ON	Y	Y	Y	Y	Y
iMG624-A	Y				
iMG634-A	Y				
iMG624-A-R2					
iMG634-A-R2					
iMG634-B-R2					
iMG634-WA-R2					
iMG634-WB-R2					
iBG915-FX					

7.15.1 System Power Management

Enabling the feature at the device level is done with the:

- RG General Profile. - Note that the default when creating the profile is Enabled.
- Service Management Form - iMG/RG -> Mgmt Info. (There is also a read-only field that shows the power system status.)

Refer to the following figures.

Create Profile Profile Name: Profile Type: RG General

Profile Attributes

Mgmt. Info | Wireless | Port Assignment | IP Routes

Attribute New Value

Profile Scoping:

iMG/RG Bootstrap VLAN Id (1..4094 or None):

iMG/RG Mgmt VC/VLAN Id (2..4094):

Include Service VLANs in Profile:

iMG/RG Internet VC/VLAN Id (2..4094 or None):

iMG/RG Video VC/VLAN Id (2..4094 or None):

iMG/RG Voice VC/VLAN Id (2..4094 or None):

iMG/RG CES VC/VLAN Id (2..4094 or None):

System Power Management: ←

Attribute New Value

Loop Detection:

SNTP Server (IP Addr. or None):

Daylight Saving:

Time Zone:

Limited User Login (login or None):

New Limited User Password:

New Manager Password:

Super User Login (login or None):

New Super User Password:

Split Management:

Subscriber User Login: admin

New Subscriber User Password: admin

Mgmt. Subnets

Name	Subnet Addr.	Mask	Start Addr.	End Addr.

Copy values from profile:

FIGURE 7-217 System Power Management - RG General Profile

Customer ID: 746SWG_2 iMG/RG IP Addr: 10.52.31.112 Video/Data Device: 10.52.30.37 Port: 4.5 POTS Device

Current Value	New Value	Current Value
iMG/RG Type: iMG746-MOD		iMG/RG General Profile: timGENERAL*
MAC Address: 00:00:0D:03:04:05		SysContact (Customer ID or None): 746SWG_2
System Up Time: 1 days 03:11:55		SysLocation (location or None): 10.52.30.37_4.5
System Power: WARNING - Ba...		SysName (system name or None):
System Power Management: Enabled	<input type="text"/>	Limited User Login (login or None): None
iMG/RG Mgmt VLAN: 7		New Limited User Password: N/A
Video VLAN: 40		New Manager Password: N/A
Internet Svc. VLAN: 20		Super User Login (login or None): None
Voice VLAN: 10		New Super User Password: N/A
Internet Local VLAN: None		
CES VLAN: None		
TLS VLAN (2..4094 or None): None	<input type="text"/>	
SNTP Server (IP Addr. or None): None	<input type="text"/>	
Daylight Saving: Disabled	<input type="text"/>	
Time Zone: EST	<input type="text"/>	

FIGURE 7-218 System Power Management - iMG/RG -> Mgmt. Info

7.15.2 LAN Ports Power Management

In 3-8, there is also for certain iMG/RGs the ability to configure power management per LAN port, so that a port is automatically disabled in case of power failure. (Before 3-8, some devices had a default setting that of disabling all LAN ports except port 1.) The NMS supports this feature on iMG/RGs as listed in Table 7-38. Refer to the *ATI Gateway Product Family Software Reference Manual* for complete information on this feature and how devices support this feature.

This option is controlled through the Advanced Port Params button on the

- RG General Profile - Refer to 7.4.2.
- Service Management Form - iMG/RG -> Port Assignments

Note: Disable on Power Failure for CES ports is not supported from the NMS.

The following figure shows the Advanced Port Attributes GUI on the Service Management Form. When Enabled is selected, the port is disabled if there is a power failure.

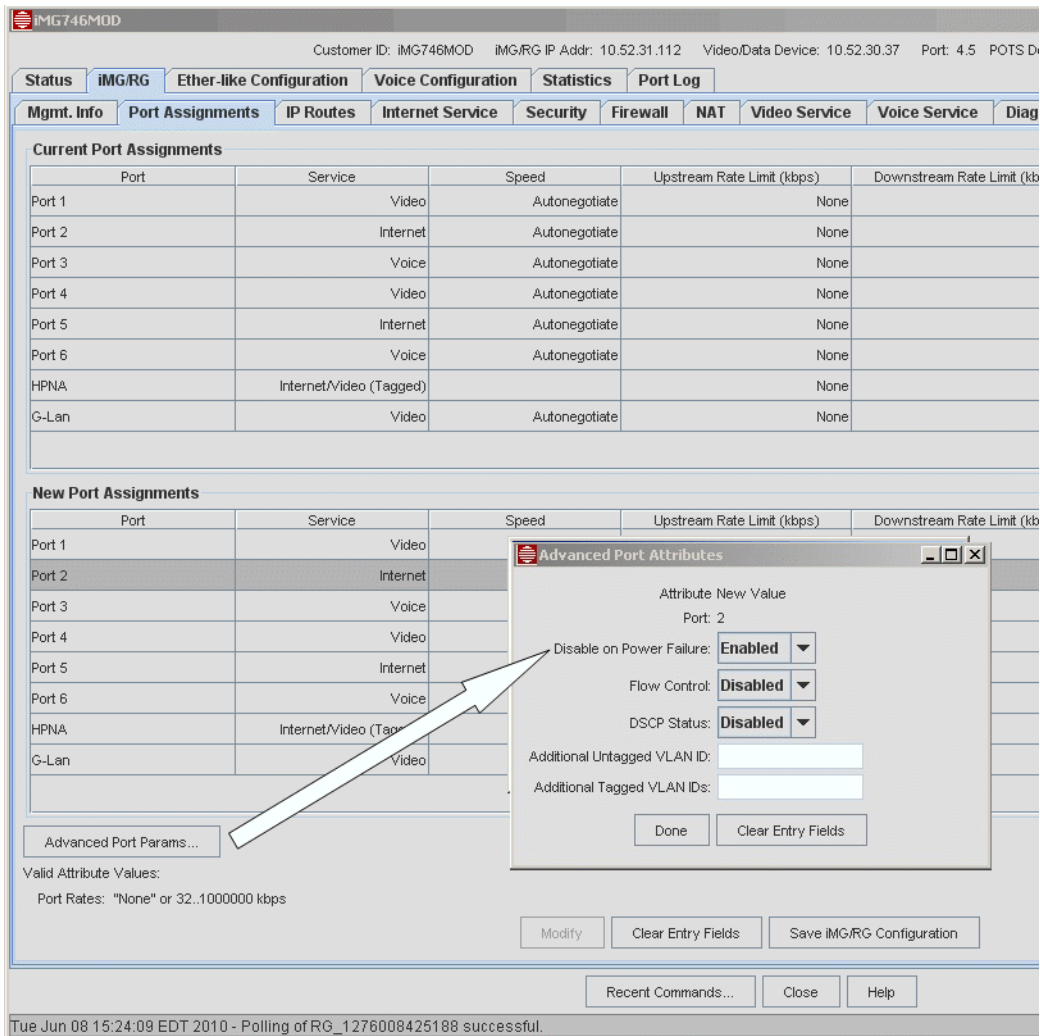

FIGURE 7-219 LAN Port Power Management on Service Management Form

7.15.3 LAN Ports State

In the Service Management Form for iMG/RG -> Port Assignments, the field **Oper. State** shows the state of the port:

- Up - Include the time the link has been active
- Down - The port is out of service because of a problem or it has been disabled.
- Power Down - The port is out of service because of the Port Power Management feature.

Note: The Up state that includes the time applies to all iMG/RGs. The Power Down appears only for the selected iMG/RGs as listed in Table 7-38.

Refer to the following figure.

1.109 Video/Data Device: 10.52.30.35 Port: 5.1 POTS Device/Port: Unconfigured

istics Port Log

ty Firewall NAT Video Service Voice Service Diagnostics

Upstream Rate Limit (kbps)	Downstream Rate Limit (kbps)	Admin. State	Oper. State
None	None	Enabled	Down
None	None	Enabled	Down
None	None	Enabled	Down
None	None	Enabled	Down
None	None	Enabled	Down
None	None	Enabled	Down
None	None	Enabled	Up / 3 days 03:50:00

FIGURE 7-220 Oper.State for Port - Link Up Time

7.15.4 TEL Ports Power Management

In 3-8, there is, similar to the LAN Port Power Management, the ability for certain iMG/RGs the ability to configure power management per voice port, so that a port is automatically disabled in case of power failure. The NMS supports this feature on iMG/RGs as listed in Table 7-38. Refer to the *ATI Gateway Product Family Software Reference Manual* for complete information on this feature and how devices support this feature.

This option is controlled through the Advanced Port Params button on the

- RG Voice Profile - Refer to 7.4.5.
- Service Management Form - iMG/RG -> Voice Service

The following figure shows the Advanced Line Attributes GUI on the Service Management Form.

The screenshot displays the 'Advanced Line Attributes' configuration window for a voice service. The window is divided into several sections:

- Current Line Configuration:** Shows a table with columns for 'Line' and 'Port State'. Line 1 is selected.
- New Line Configuration:** Shows a table with columns for 'Line' and 'Port State'. Line 1 is selected.
- Advanced Line Params...:** A button to access advanced parameters.
- Configuration Fields:** A list of attributes with their current and new values:
 - Voip Provider Interface: None
 - Line: 1
 - Port State: Disabled (indicated by a red arrow)
 - Disable on Power Failure: Enabled
 - Country: USA
 - On Hook Time (100..5000 msec): 1000
 - Flash Hook Time (80..1000 msec): 600
 - Off Hook Time (100..5000 msec): 250
 - Jitter Mode: Fixed
 - Jitter Delay (20..200 msec): 130
 - TX Gain (-30.0..39.5 dB): 0.0
 - RX Gain (-30.0..39.5 dB): -3.0
 - Fax/Modem Detection: Enabled
 - Digit Map: *#x,T
 - CODECs: g711u,g726-32,138
 - Comfort Noise Generation: OFF
 - Voice Activity Detection: OFF
 - IDT Critical Min. (0..999 msec): 0
 - IDT Critical Max. (1..60 sec): 10
 - IDT Partial Min. (0..999 msec): 0
 - IDT Partial Max. (1..60 sec): 10
 - Stutter Dial Tone: [Dropdown]
 - Unregistered Tone: [Dropdown]
- Call Services:** Fields for Call On Hold Service, Call Waiting Service, Call Waiting Active Prefix, Call Waiting De-active Prefix, Call Fwd. All-Calls, All-Calls On Prefix, All-Calls Off Prefix, Call Fwd. On-Busy, On-Busy On Prefix, On-Busy Off Prefix, Call Fwd. On-No-Answer, On-No-Answer Timeout (secs), On-No-Answer On Prefix, On-No-Answer Off Prefix, Internal 3-way Calling, Internal 3-way Call Prefix, Blind Call Transfer, Blind Call Transfer Prefix, Attended Call Transfer, Attended Call Transfer Prefix, and Dial Mode.

FIGURE 7-221 Controlling power Management for Voice Lines on Service Management Form

7.15.5 Voice Ports State

Also on the Advanced Line Params for voice service is a read-only field that shows the state of the port:

- Busy - The line is being used. Note that during this state, it cannot be powered down by the Power Management feature if there is a loss of power.
- Idle - Line is ready to place and receive calls.
- Out of Service - Line has been disabled.

- Powered Down - The Power Management Feature has activated and on the voice port the Disable on Power Failure was set to Enabled.

This status field can be seen on Figure 7-221.

7.16 LAN Flow Control

On ingress traffic, when internal ingress queues are almost full or the rate limit is exceeded, the iMG/RG sends a PAUSE frame for all traffic on the port. (The downstream device must ensure traffic is not lost.)

The feature is included in the Advanced Port Attributes panel for the RG General Profile and the Service Management Form. Refer to the following figures.

The screenshot shows the 'Create Profile' configuration interface. The 'Profile Name' field is empty, and the 'Profile Type' is 'RG'. The 'Profile Attributes' section is active, with the 'Advanced Port Attributes' panel open for 'Port: 2'. The 'Flow Control' attribute is set to 'Enabled'. The 'PortAssignments' table is visible in the background, with a white arrow pointing from the 'Port 1' row to the 'Flow Control' dropdown menu.

Port	Service
Port 1	Internet
Port 2	Internet
Port 3	Video
Port 4	Video
Port 5	Internet
Port 6	None
Wireless	None

Advanced Port Attributes for Port: 2

Disable on Power Failure: Disabled

Flow Control: Enabled

DSCP Status: Disabled

Additional Untagged VLAN ID:

Additional Tagged VLAN IDs:

Done Clear Entry Fields

FIGURE 7-222 Flow Control for LAN Ports - RG General Profile

Customer ID: IMG746MOD IMG/RG IP Addr: 10.52.31.112 Video/Data Device: 10.52.30.37 Port: 4.5 POTS Device/Port: 4.5

Navigation: Status | **IMG/RG** | Ether-like Configuration | Voice Configuration | Statistics | Port Log

Sub-navigation: Mgmt. Info | **Port Assignments** | IP Routes | Internet Service | Security | Firewall | NAT | Video Service | Voice Service | Diagnostics

Current Port Assignments

Port	Service	Speed	Upstream Rate Limit (kbps)	Downstream Rate Limit (kbps)
Port 1	Video	Autonegotiate	None	None
Port 2	Internet	Autonegotiate	None	None
Port 3	Voice	Autonegotiate	None	None
Port 4	Video	Autonegotiate	None	None
Port 5	Internet	Autonegotiate	None	None
Port 6	Voice	Autonegotiate	None	None
HPNA	Internet/Video (Tagged)		None	None
G-Lan	Video	Autonegotiate		

New Port Assignments

Port	Service	Speed
Port 1	Video	Autonegotiate
Port 2	Internet	Autonegotiate
Port 3	Voice	Autonegotiate
Port 4	Video	Autonegotiate
Port 5	Internet	Autonegotiate
Port 6	Voice	Autonegotiate
HPNA	Internet/Video (Tagged)	
G-Lan	Video	Autonegotiate

Advanced Port Attributes

Attribute Current Value New Value

Port: 2

Port State: In Service

Disable on Power Failure: Enabled

Flow Control: Enabled

Done Clear Entry Fields **Enabled** / **Disabled**

FIGURE 7-223 Flow Control for LAN Ports - Service Management Form

7.17 Port-Based Rate Limiting - Reference

Following are the rules and tables to use to select port-based rate limiting for the iMG/RG for that include release 3-7. The settings that are possible depend on the type of iMG/RG and the software release that the device is using. The following table lists the device types and loads supported. Refer to this table when reviewing the rate limits.

Note: A value of 0 disables the tx or rx ratelimiting function.

Note: Careful consideration must be given during the creation/planning of the iMG/RG General Profiles which establish the setting for ratelimiting. Otherwise you may get an alarm indicating a device's settings are out of sync with the applied profile every rediscovery period. This will most likely happen if you created a profile setup with rate limiting setting for a one iMG/RG type (such as an iMG646) and you apply the profile to a different type that has different rate settings. This is why the administrator is advised to create profile names that minimize confusion.

Note: If these values are not input, the rate rounds down to the next available rate.

TABLE 7-39 Functional Groupings of iMG/RG

Group	Model	Load Name	Characteristics	Uniqueness
Fiber A	rg613TX, BD, LH, SH	rg600E	4/16 Meg Flash/Ram	Initial product offering
	rg623TX, BD, LH, SH		Kendin Switch	
			Ni-210 Processor	
Fiber B	rg656BD, LH, SH	RG6x6E	4/16 Meg Flash/Ram	More efficient routing when VLANs configured. Similar service offering to Modular Devices
	iMG606BD, LH, SH		Broadcom Switch	
	iMG646BD, LH, SH		Ni-210 Processor	
	iMG646BD-ON/PX-ON			
Fiber C	iMG616BD, LH, SH	iMG616E	4/16 Meg Flash/Ram	Base Platform that provides capability for RF overlay.
	iMG616RF, RF+,		Broadcom Switch	
	iMG616SRF, SRF+		Ni-210 Processor	
Fiber D	iMG616W	iMG616W	8/32 Meg Flash/RAM	New indoor wireless product - greater processing capacity - and wireless support
	iMG606BD-R2	iMG606BD-R2	Broadcom Switch	
	iMG616BD-R2	iMG616BD-R2	Solos Processor	
Fiber E	iBG915FX	iBG915	8/32 Meg Flash/RAM	New Multi port Tel port offering. SFP provides for WAN flexibility.
			Marvell Switch	
			He-520 Processor	
Modular	iMG626MOD	iMG626	8/32 Meg Flash/RAM	Modular outdoor devices - provide support for different WAN services - and additional LAN interfaces.
	iMG646MOD	iMG646	Marvell Switch	
	iMG726MOD	iMG726	He-520 Processor	
	iMG746MOD	iMG746		
	iMG726BD-ON	iMG726	(non-modular)	
ADSL A	iMG624A/B	iMG624A/B	8/32 Meg Flash/RAM	Second Generation ADSL CPE.
	iMG634A/B	iMG634A/B	Kendin Switch	
	iMG634WA/B	iMG634A/B	Argon Processor	

TABLE 7-39 Functional Groupings of iMG/RG (Continued)

Group	Model	Load Name	Characteristics	Uniqueness
ADSL B	iMG624A-R2	iMG624A-R2	8/32 Meg Flash/RAM	Third Generation ADSL CPE - Greater performance - able to support 2 INP.
	iMG634A/B-R2	iMG634A/B-R2	Marvell Switch	
	iMG634WA/WB-R2	iMG634WA/WB-R2	Solos Processor	
ADSL C (no NMS support)	iBG910A/B	iBG910A/B	8/32 Meg Flash/RAM	Multi-line ADSL Gateway supporting both ISDN and POTS.
			Marvell Switch	
			Argon Processor	

TABLE 7-40 Port Rate Limits - Rules (Based on Functional Group)

Group	Rule / Load	Range
Fiber A	Same as 3-5	
Fiber B	Broadcom based	None 128Kbps 256Kbps 512Kbps 756Kbps 1Mbps 1.5Mbps 2Mbps 3Mbps 4Mbps 5Mbps 6Mbps 7Mbps 8Mbps 9Mbps 10Mbps 12Mbps 14Mbps 16Mbps 18Mbps 20Mbps 25Mbps 30Mbps 35Mbps 40Mbps 45Mbps 50Mbps 60Mbps 70Mbps 80Mbps 90Mbps
Fiber C	Broadcom based	0 to 1792 Kbps in 64K increments, then 2000 to 12000 in 1Mbps increments
Fiber D	Broadcom based	Refer to Fiber B
Fiber E	Marvell based	None 128Kbps 256Kbps 512Kbps 1Mbps 2Mbps 4Mbps 8Mbps
Modular	Marvell based	For iMG626MOD and iMG646MOD, refer to Fiber E For iMG726MOD and iMG746MOD, refer to Fiber B ¹
ADSL A	Kendin based	0 to 12000 in 32Kbps increments
ADSL B	Marvell based	Refer to Fiber E
ADSL C	Marvell based	Refer to Fiber E

1. With Copper Gig Port, can go above 100Mbps.

8. Setting Up Performance Management

8.1 Overview

Performance monitoring basically means collecting useful data from network devices and determining how efficiently the network is functioning. *Performance* is measured based on factors such as:

- Number of bytes of data received (over a period) by a particular interface of a device.
- Number of bytes of data sent (over a period) by a particular interface of a device.
- An estimate of the interface's current bandwidth in bits per second.

The data pertaining to a network device are collected based on the definition of performance variables (called **Statistics**).

Note: During startup, the AlliedView NMS server creates a set of default statistics that are inactive. Figure 8-1 shows these default Statistics.

Once the AlliedView NMS server starts, data collection starts automatically. Data is collected from the devices listed under the **Hosts** list in the Configured Collection panel, as shown in Figure 8-1. Data is collected only for those Statistics listed in the panel that have been defined.

Performance configuration involves a series of steps that must be understood in sequence so that the Administrator can ensure that all devices in the network are operating efficiently and that any degradation in performance is reported to users as quickly as possible. Once the purpose of these steps is explained, the specific tasks can be shown.

Overall, performance management involves three main areas:

1. Data Collection

To configure data collection means to define from which devices (managed objects) data will be collected, what data to collect, and how the data will be filtered before it is stored in the database.

2. Threshold Configuration

As the data is collected and scored, it needs to be checked against threshold values to provide a method to see that the device performance is degrading.

3. Reporting

As the data is collected and thresholds are checked, users must be notified.

The settings for Performance Management are in a set of configuration files (**.conf**) in Extended Markup Language (XML) format.

Warning: Editing configuration files directly should only be done under the supervision of Allied Telesis support personnel, since it is very easy to delete or change data collection that would result in a loss of performance monitoring for devices. Use the forms and menus described in this section to set up Performance Management.

Use the following table to locate the task you wish to perform. Use the screen or form name to locate the relevant section.

TABLE 8-1 Task List for Performance Monitoring

Task	Screen / Form Name (if Applicable)	Section
Data Collection Screen	Configured Collection	(8.2.2)
Data Collection (Statistics)		
- Overview		(8.3.1)
- Create Polling Filters	Create, Modify, Delete	(8.3.2)
- Create Statistic	DataCollection Detailed Properties	(8.3.3)
Thresholds		
- Overview		(8.4.1)
- Configure Thresholds	Threshold Properties	(8.4.2)
- Associate Threshold with Statistic	Threshold Properties	(8.4.3)

8.2 Data Collection Screen

8.2.1 Overview

You can view the list of statistics associated with each of the ManagedObjects discovered in the network via the **Configured Collection** panel.

Note: A Managed Object (MO) represents a network element for which data has to be collected. It can be a node, interface, a port, a card, a slot, etc.

8.2.2 Screen Components for Statistics

To access the Data Collection screen, perform the following:

1. Select Configured Collection node from the tree in the left frame. You can see the Configured Collection panel in the right frame, which displays a list of nodes under the **Hosts** column. This list indicates that these ManagedObjects have been identified in the network for data collection.
2. Select any of the hosts, and you will see the associated Statistic. (Each row of information is called a Statistic). Refer to the following figure.

Hosts	Statistic Name	Poll Id	DNS Name	Data Identifier	Community
serveruc.lab.telesyn.corp	#OutOctets	2709	serveruc.lab.telesyn.corp	1.3.6.1.2.1.2.2.1.16	public
servermc.lab.telesyn.corp	#OutErrors	2711	serveruc.lab.telesyn.corp	1.3.6.1.2.1.2.2.1.20	public
desktop1.lab.telesyn.corp	#OutDiscards	2713	serveruc.lab.telesyn.corp	1.3.6.1.2.1.2.2.1.19	public
content-rt1.lab.telesyn.corp	#InOctets	2708	serveruc.lab.telesyn.corp	1.3.6.1.2.1.2.2.1.10	public
ar410-1.neteng.lab.telesyn.corp	#InErrors	2710	serveruc.lab.telesyn.corp	1.3.6.1.2.1.2.2.1.14	public
ai03-rt2.neteng.lab.telesyn.corp	#InDiscards	2712	serveruc.lab.telesyn.corp	1.3.6.1.2.1.2.2.1.13	public
ai00-rt1.lab.telesyn.corp	#InStatsOverSizePkts	2720	serveruc.lab.telesyn.corp	1.3.6.1.2.1.16.1.1.9	public
10.52.32.8	etherStatsPkts65to127Octets	2726	serveruc.lab.telesyn.corp	1.3.6.1.2.1.16.1.1.15	public
10.52.32.5	etherStatsPkts64Octets	2725	serveruc.lab.telesyn.corp	1.3.6.1.2.1.16.1.1.14	public
	etherStatsPkts512to1023Octets	2729	serveruc.lab.telesyn.corp	1.3.6.1.2.1.16.1.1.18	public
	etherStatsPkts256to511Octets	2728	serveruc.lab.telesyn.corp	1.3.6.1.2.1.16.1.1.17	public
	etherStatsPkts128to255Octets	2727	serveruc.lab.telesyn.corp	1.3.6.1.2.1.16.1.1.16	public
	etherStatsPkts1024to1518Octets	2730	serveruc.lab.telesyn.corp	1.3.6.1.2.1.16.1.1.19	public
	etherStatsPkts	2716	serveruc.lab.telesyn.corp	1.3.6.1.2.1.16.1.1.5	public
	etherStatsOverSizePkts	2721	serveruc.lab.telesyn.corp	1.3.6.1.2.1.16.1.1.10	public
	etherStatsOctets	2715	serveruc.lab.telesyn.corp	1.3.6.1.2.1.16.1.1.4	public
	etherStatsMulticastPkts	2718	serveruc.lab.telesyn.corp	1.3.6.1.2.1.16.1.1.7	public
	etherStatsJabbers	2723	serveruc.lab.telesyn.corp	1.3.6.1.2.1.16.1.1.12	public

FIGURE 8-1 Collection View Panel

The following table lists the components in the following figure.

TABLE 8-2 Data Collection Screen Components

Component	Description for Data Collection Screen Components
Property Columns	<p>For every statistic the associated properties are displayed in columns, such as Statistic name, Poll ID, Data Identifier, DNS Name, interval etc. Some of the properties are as follows:</p> <p>Statistic Name - A string to identify the Statistic uniquely. This should be a meaningful name describing the Statistic.</p> <p>Poll ID: A unique number associated with each Statistic to identify the Statistic. Poll ID is automatically generated so no two Statistics will have the same Poll ID.</p> <p>DNS Name: This is the Host name (device name) with which this Statistic is associated.</p> <p>Data Identifier: This is the Identification number of the device interface from which data about the device is to be collected. This Data Identifier is otherwise called as OID and it is unique for every device. A list of possible OIDs for a device exists in the MIB definition of the device.</p> <p><i>Note: To view the OIDs of nodes and interfaces for a device, use the MIB browser. Refer to Section 11.</i></p> <p>Interval - This specifies the time interval at which data should be collected for the Statistic. For example, the value 300 indicates that after every 300 seconds, data is collected.</p>
Page Length	The drop-down box labeled Page Length displays a number of hosts to be displayed per page. By default, it is set to 10. Hence you can see ten hosts displayed in the left panel of the Configured Collection frame. You can select other values such as 20, 30, 40, 50 etc. and view that number of hosts together.
From and To Range	There are two text boxes available labeled Displaying and To. You can set values in these, press Enter, and see the hosts list in that range. For example, if you set Displaying as 4 and To as 13, then you will be able to view from Host 4 to Host 13. By default, the hosts are displayed in reverse alphabetical order.
Navigation Buttons	You can see four navigation buttons provided at the top right of the frame. They are Go to first page, Go to previous page, Go to next page and Go to Last page respectively. They will get automatically enabled and disabled based on your choice of page length and total number of hosts.
Total	This text box cannot be edited and it shows the total number of hosts available for data collection.

*Note: The green branch-like image adjacent to the Statistic name denotes the type of Statistic. Statistics are of three types: **Node**, **Interface**, and **Multiple**. The symbol with multiple branches  denotes that the statistic is of type Multiple. (A multiple type contains one node and all interfaces.)*

If no data are to be collected for a Statistic, the data are disabled temporarily. In such a case, the Statistic row is displayed in blue color. Once it is activated, the row color changes to green.

*Note: You can see the number of events that have been generated of different severity in **Alarm count by severity** panel.*

8.3 Data Collection

8.3.1 Overview

Data collection is done using the flowchart shown in the following figure.

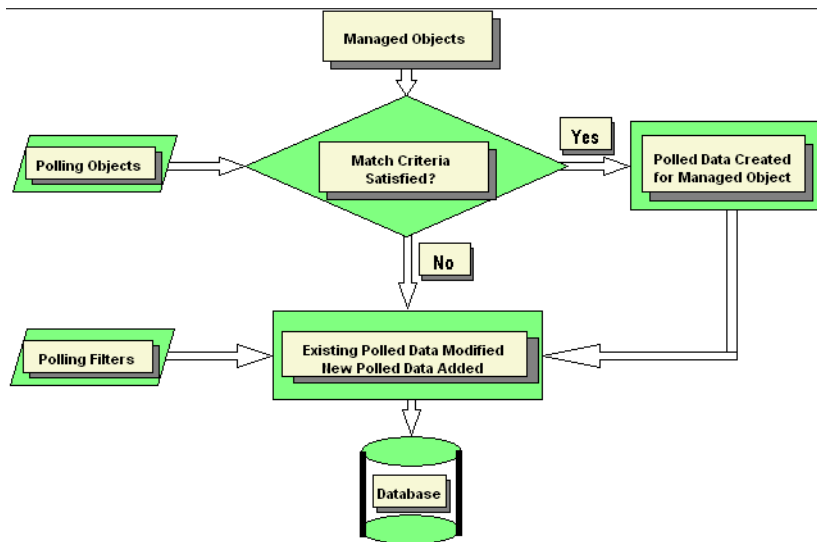

FIGURE 8-2 Data Collection Flow

The flowchart elements are as follows:

- Managed Object - Created by the Topology feature, it is an entity that represents a device or part of a device (such as a port, card, or interface), and has properties.
- Polling Object - Created by Performance Management, it is an object that has two properties:
 - Match Criteria
 - Data Collection Criteria
- Polled Data - The actual name (statistic) for the data to be collected in the database. Examples would be **Interface_In_Octets** or **Ether_History_Octets**.
- Poll Filter - The Polled Data for the Managed Object is filtered so that existing polled data can be modified/deleted, or new polled data can be added.

When the server starts up, the definitions in the AlliedView NMS internal files are used as follows:

1. Polling Objects are created based on a AlliedView NMS internal file. Each Polling Object has the two criteria, Match and Data Collection.
2. When Topology creates a Managed Object, the MO is passed through the Polling Object, where the properties of the MO are compared to the match criteria of the Polling Object.
3. If there are match criteria, PolledData is created for entry in the Data Collection criteria.
4. If there are no Polling Filters, the PolledData goes directly to the database.
5. If there are Polling Filters, the PolledData is passed through the Polling Filter one by one and is modified as specified by the filter. Then the data can be sent to the database.

The following subsections show how to add these Performance Management modules.

8.3.2 Polling Objects

A Polling Object is used for creating a single collection point for multiple devices. To add, modify, or delete a Polling Object, select **Edit -> Polling Objects**. The following figure appears.

FIGURE 8-3 Modify Polling Properties Form - File

8.3.2.1 Adding a Polling Object

To add a polling object:

1. Select the **Add** radio button under the list of polling objects (left panel).
2. Fill in the fields under **Polling Properties** as follows:
 - **Name** - Required, a string to identify the Polling Object.
 - **Status** - Checked means active and so the data collection for the associated Polled Data can be done. When unchecked, data collection for associated Polled Data is stopped. Default is checked.
 - **Update Discovered Devices** - Checked means the Polling Objects definitions will be applied over existing MOs and they will updated with the information input here. If unchecked, the Polling Object will be used for newly created MOs only.
3. Specify at least one criteria under **Device Match Criteria** and set it against a string or numeric value. Following are the default set of MO properties:

- Global: status, type, managed,
- Boolean: isGroup, isContainer, isSNMP, is DHCP, isRouter, isNode, isNetwork, isInterface,
- System: sysName, sysOID,
- Interface: ifSpeed, ifDescr, ifIndex

Use the **More** and **Fewer** buttons to get the correct number.

Note: The **Fewer** button will remove the last criteria you added.

The criteria are set as an AND condition. To change this, define a **User Class**. Contact ATI support for examples of user class files on the AlliedView NMS Server.

4. Under **Collection Statistics**, select the **Add** radio button, and fill in the fields as described in the following table.

Note: Choosing the type and location of data from the MO is done through the MO's agent, which is the program that receives and processes the data request, and the Object Identifier (OID), which is the unique number that identifies that characteristic for the MO. The list of OIDs is retrieved from the MIB definition of the device. To view the OIDs for a device, use the MIB Browser tool.

TABLE 8-3 Data Configuration Fields

Field	Description
OID Prefix	Normally the Data identifiers are lengthy. For the identifiers that have in common the starting n digits, you can specify that as prefix. For example, assume two Statistics, IfSpeed and IfInOctect. The corresponding Data identifiers are .1.3.6.1.2.1.2.2.1.5.1 and .1.3.6.1.2.1.2.2.1.10.1. You can see the first part .1.3.6.1.2.1.2.2.1 is common to both, so you can specify the common prefix as .1.3.6.1.2.1.2.2.1 . Even if you do not specify the prefix, Performance module will add the prefix to the identifier.
Default Polling Interval	The time interval for periodic data collection. For example, if set to 5, then for all the Data identifiers, data will be collected once in every 5 seconds. Default value: 300 seconds.
Name	Any meaningful string for the Data identifier. Required
OID	A unique Object Identifier string that represents a MIB entry. Data is collected for this identifier. An SNMP-specific Data identifier is called an OID . For example . 2.2.1.16.1 refers to IfInOctects interface instance 1. Required .
Type	This can be set to interface, node, multiple, or none. Node - Used when Data identifier is of type Scalar. If you choose the type to be Node you must specify the full OID. For example to collect data for Interface_in_octets instance 1 then choose this type and specify the data identifier as 2.2.1.10.1. Interface - Exclusively for IF table entries of RFC 1213 MIB, only . This is used when the data identifier has many instances. When you want to collect data for all the instances of an OID choose the type to be Interface. Enter the data identifier as 2.2.1.10. For every instance of the OID, a PolledData will be created. Multiple - This type can be used to collect data for OIDs that have multiple instances. As Interface type is specific to IF table entries for other OIDs that have multiple instance you can choose the type as Multiple. Only one PolledData will be created for the OID specified but data collection will be done for all the instances. None - Used when other protocols are used for data collection apart from SNMP. Default value: None.
Polling Interval	The time interval for periodic data collection. For e.g. if set to 2, it indicate that for all the Data identifiers, data will be collected once in every 2 seconds. Default: 300 seconds.
Active	If you uncheck the checkbox, data collection will be temporarily stopped for this Data identifier. To resume data collection you will have to check this checkbox. Default: True (checked).

TABLE 8-3 Data Configuration Fields

Field	Description
Save Collected Data	If unchecked, specifies data will not be stored, and can be viewed only by the Real Time monitoring using Current StatisticGraph you do not want to store the collected data, “uncheck” this check box. Default: True (Checked).
Save Absolute	This option is applicable only for Counter type OIDs. By default, data collected for Counter type OIDs is not stored as it is. The difference between the previous data and latest data is collected and stored. If the exact value (absolute value) of collected data has to be stored for Counter type OIDs then this check box should be checked. Data collected for OIDs of other data types are saved as absolute values. Default: False.
Time Average	If you check this checkbox then the Time Average will be calculated as (Latest collected value + Previous value) / Difference in Data collection Time value. This is mostly calculated for Counter type and Gauge type Data identifiers where the data collected will be an incremental value and at one point will reach the final value and reset to Zero. As this reset may happen soon and very often, it is preferred that a Delta value is derived from two consecutive Polls. Default: false.
Use Threshold	Check to apply threshold for this Identifier. Default: False (unchecked).
Threshold List	A list of thresholds to apply to this data. Click the ellipses (...) to get a pop-up list of applicable thresholds. Select the desired thresholds from the pop-up list (Shift+click to select multiple thresholds), and then click OK in the pop-up window.
Failure Threshold	Number of consecutive failures after which the threshold event should be generated. This can be used where a single Poll (Datacollection for the Data identifier) is not stable. For example, assume the Data identifier has a threshold associated and it is predicted that the data collected can be crosschecked 3 times. If the collected value still exceeds the Threshold value then it means that the collected data is stable and this may result in Performance degradation. Default: 1.
Log Directly	This option allows the polled data to be saved directly to a text file (comma-separated). The text file will be located in the NMS Server installation directory on the NMS host machine and will be named <device name or IP address>_<polled data name>.txt (e.g. 172.16.33.2_ifInOctets.txt). <i>Note: This option is useful for quickly viewing the raw values as they are collected form polling but should not be used for long term data collection to avoid filling up the NMS server disk storage.</i>

After filling in these fields for an Identifier, click **Apply** and it will be added to the Data Identifier List. Once added, you can click **Modify** to modify the Identifier or **Remove** to remove it.

Once all the Identifiers have been configured, click **Apply**. This adds the Polling Object to the database and the statistic to the Configured Collection Panel.

8.3.2.2 Modify a Polling Object

Once set up, modifying the Polling Object will be necessary when you:

- Stop data collection for all the associated Polled Data
- Modify the properties of existing Data Identifiers
- Add new Data Identifiers to add to the Polled Data

To modify a Polling Object, select **Edit -> Polling Objects**, and then perform these steps:

1. Select the polling object from the left panel, and then select the **Modify** radio button just below the list.
2. Under Polling Properties, change the **Active** and **Update Managed Objects** checkboxes, if desired.

*Note: The information under **Device Match Criteria** is not editable.*

3. Under **Collection Statistics**, select a Data Object from the list and change the field values as needed.

Note: Check the **Advanced** checkbox to enable all of the fields and checkboxes, if necessary.

Repeat for each Data Object you need to change.

4. When you are done, click **Apply** to make the change to the database.

8.3.2.3 Delete a Polling Object

Deleting a Polling Object means to delete all the statistics associated with the Data Identifiers.

To delete the Polling Object, select *Edit -> Polling Objects*, and then perform these steps:

1. Select the Polling Object on the left panel, and then select the Modify radio button just below the list.
2. Click the **Remove** button at the bottom of the form. A confirmation box asks to confirm the delete.
3. Click **Yes** and the Polling Object will be removed from the left pane.

You can view the results in the Configuration Collection panel, where the Statistics associated with the Polling Object are deleted.

8.3.3 Add a Statistic

A Statistic may need to be added to a specific device. For such small changes, select *Edit -> Add Statistic*. The **Modify Polled Data** form will appear, as shown in [Figure 8-4](#).

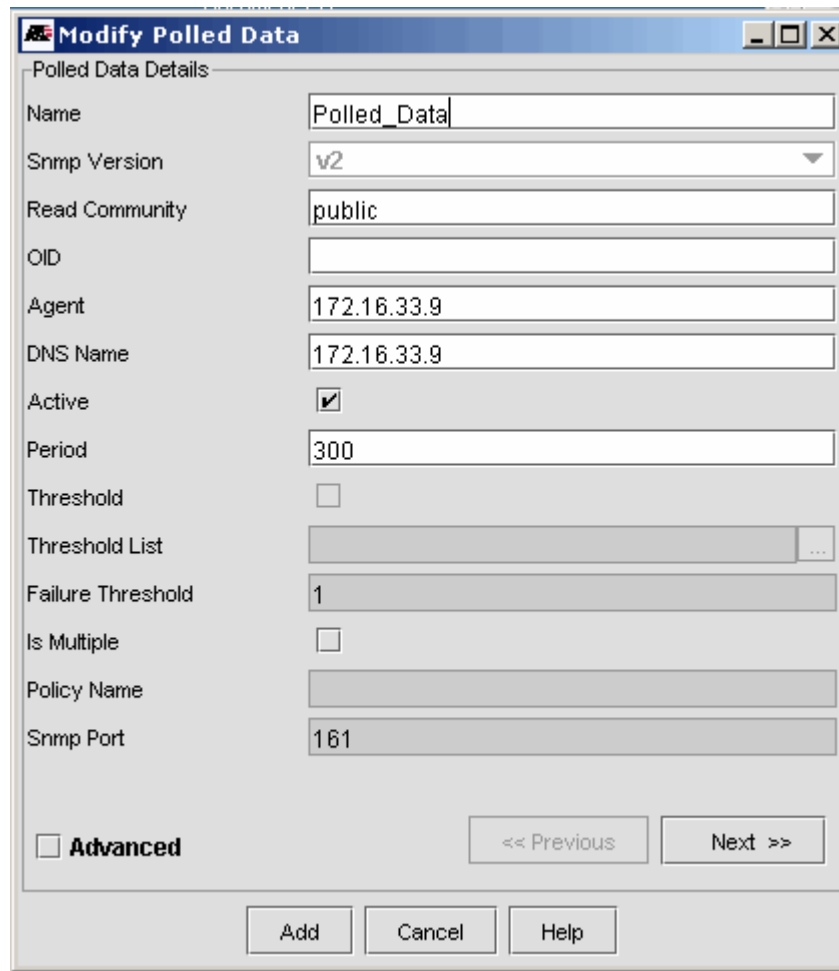

FIGURE 8-4 Data Collection for Adding a Statistic

The following table lists the properties and descriptions.

TABLE 8-4 Properties for Adding a Statistic

Property	Description
Name	Any meaningful string for the Data Identifier. Required.
SnmpVersion	One of the three SNMP versions - V1, V2 or V3. Required.
Read Community	Enter the string with which the devices are identified in a network. Most of the equipment vendors set the Community value as public for their devices, so it is usually used here. Otherwise you have to check the string used for the particular device. <i>Note: The community specified must be enabled on the device.</i>
OID	A unique Object Identifier string that represents a MIB entry. Data is collected for this identifier. An SNMP specific Data identifier is called an OID . For example, 2.2.1.16.1 refers to IfInOctects interface instance 1. Required.
Agent	Normally a device will have one agent in it to collect device data, and the device name and agent name will be the same. Required.
DNS Name	Name of the device from which data have to be collected.

TABLE 8-4 Properties for Adding a Statistic (Continued)

Property	Description
Active	If you uncheck the check box, the data collection will be stopped for this OID. (The statistic row once created will be blue.) To activate data collection, check the box. Default value: True (checked).
Period	The time interval for periodic data collection. For example, if set to 2, for all the Data identifiers, data will be collected once in every 2 seconds. Default value: 300 seconds.
Threshold	Checking means the Threshold will be applied on this Data identifier. Unchecked means no Threshold will be applied. Default value: False (unchecked).
ThresholdList	Name of the Thresholds in comma separated format, thus associating them to this Data identifier for monitoring data collection.
Failure Threshold	Threshold at which a failure is declared.
isMultiple	Checking means the data identifier is of type multiple.
Policy Name	The name of the polling policy.
Snmp Port	Specify the Port No over which device data is passed to the AlliedView NMS by the device agent. The default SNMP agent port is 161. Required.
Advanced	Allows the optional values to be modified.
Protocol	SNMP, TL1 or any other protocol used by you for data collection. The default protocol SNMP will be assumed for data collection.
Save	Whether to view the data only by Real Time monitoring using Current Statistic Graph. To specify that you do not want to store the collected data, uncheck this check box. Default value: True (Checked).
saveAbsolutes	This option is applicable only for Counter type OIDs. By default, data collected for Counter type OIDs is not stored as it is. The difference between the previous data and latest data is collected and stored. If the exact value (absolute value) of collected data has to be stored for Counter type OIDs, then this check box should be checked. Data collected for OIDs of other data types are saved as absolute values. Default value: False (Unchecked).
SaveOn Threshold	Possible values are true and false. If true the collected data is saved only when it exceeds the threshold. Default value: false
Time Average	Checking means the Time Average will be calculated as follows: (<Latest collected value> + <Previous collected value>) / <Difference in data collection Time value> This is mostly calculated for counter type and gauge type OIDs where the data collected will be an incremental value and at one point will reach the final value and reset to zero. As this reset may happen soon and very often, it is preferred that a delta value is derived from two consecutive polls. Default value: false.
Last Counter Value	The counter value last read.
Last Time Value	The time the counter was last read.
Next Time Value	The next time the counter will be read.
Log Directly	Checking means to store the collected data in flat files rather than storing them in database. Default value: false (unchecked).
Log File	The log file name with a full path (the location on the hard disk as where the log file has to be stored).

TABLE 8-4 Properties for Adding a Statistic (Continued)

Property	Description
parentObj	Name of the Managed Object which acts as the parent for this Data Identifier.
Poll ID	A unique number associated with each Statistic to identify the Statistic. Poll ID is automatically generated so no two Statistics will have the same Poll ID.
Advanced	Allows the optional values to be modified.

8.3.3.1 Modify a Statistic

To modify a Statistic, in the Configured Collection table, select a Statistic, and then select *Edit -> Modify Statistic*. In the editable fields of the **Polled Data Details** form, make the appropriate changes (refer to 8.3.3), and then click **Modify**. The changes are made immediately.

An example would be to check the **Active** checkbox. Clicking **Modify** would make the statistic active and the row would turn green.

8.3.3.2 Remove a Statistic

To delete a statistic in the Configured Collection table, select a Statistic, and then select *Edit -> Remove Statistic*. A confirmation dialog box will appear. Once the **Yes** option is clicked in the confirmation dialog, the Statistic is deleted from the database.

8.3.3.3 Example of Adding a Statistic

To add a Statistic, perform the following steps:

1. In the Configured Collection panel, select the device on which you want to add the statistic.
2. Select *Edit -> Add Statistic* from the menu. The form shown in [Figure 8-4](#) will appear.
3. Enter a name for the statistic in the **Name** field.
4. Enter the OID for the value to be polled in the **OID** field.
5. Uncheck the **Active** checkbox if you do not want this statistic to be active at this point.
6. Check the **Advanced** checkbox, then set the threshold values as needed.
7. Click **Next**.
8. If not already checked, check the **Advanced** checkbox, and then change the values as needed.
9. Click **Add**. Your new statistic will appear in the Configured Collection panel. If **Active** was checked, it will be enabled (green).

8.4 Threshold Notification

8.4.1 Overview

Performance monitoring involves two concepts:

- Data is collected from agents of network devices and stored.
- The collected data is cross-checked with threshold values. If it exceeds the limits of threshold values, a notification can be sent to the user indicating that network performance is degrading.

A threshold has the following:

- Value
- Type
 - Max - When collected data exceeds a value, report an error

- Min - When collected data drops below a value, report an error
- Equal - When collected data equals a value, report an error
- What message should be generated when the threshold is exceeded.
- At what value should this threshold get reset.

Thresholds are defined and associated with statistics. A single statistic can have many thresholds indicating a severity such as Critical, Major, Minor, etc. Whenever data is collected for the statistic, it is cross-checked with the associated thresholds. If the collected value exceeds the thresholds, then the threshold message is displayed.

Refer to the following figure.

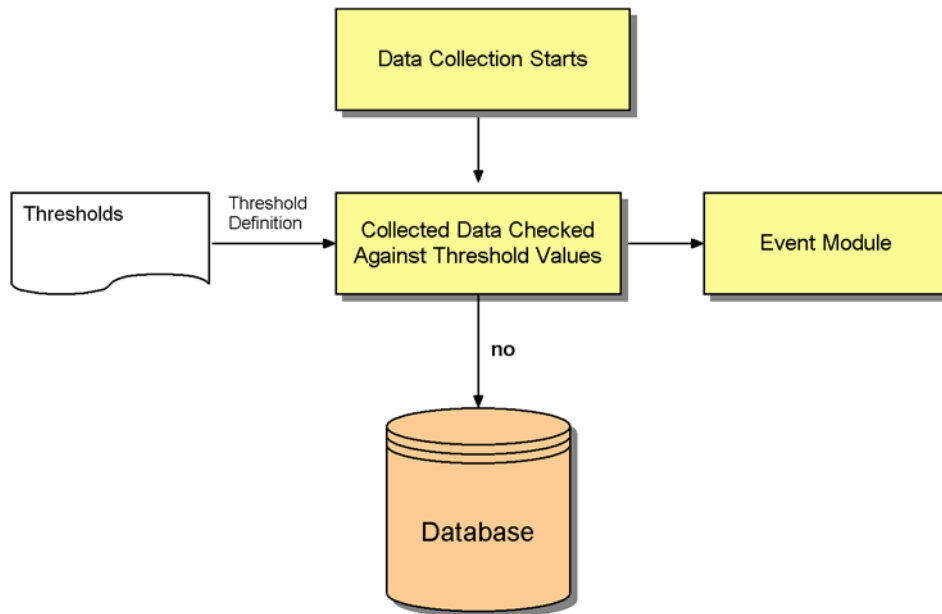

FIGURE 8-5 Threshold Processing

Thresholds can be created, modified, or deleted directly in the AlliedView NMS internal file by defining the attributes of the thresholds.

Warning: Editing configuration files directly should only be done under the supervision of Allied Telesis support personnel, since it is very easy to delete or change thresholds that would result in a loss of threshold monitoring for devices. Moreover, any changes in one file need to be coordinated with changes in other files. Use the forms and menus described in this section to set up thresholds.

There are three threshold types:

- Long Values

Thresholds can be associated with Data identifiers for which data collected is of type long. Some of such sample Data identifiers are IfAdminStat, IfOperStat etc. in RFC 1213 MIB. The value you provide for this Threshold will be compared as it is with data collected for the identifier.

- String Values

Thresholds can be associated with Data identifiers for which data collected is of type string. An example is SysDescr. To monitor a change in system description use String Thresholds.

- Percentage Values

Assume you want to set the number of pages to be loaded in a printer to depend on the Toner level. Moreover, when the toner level is 80% of the number of pages to be printed, you wish to be notified. To achieve this, you create a Percentage Threshold with a value 80. Collect data for two Statistics, Toner level and Number of pages in the printer. Divide the first by the second to find the percentage. If the resulting value exceeds the Threshold value (80), then you will receive notification. The steps are:

1. Data will be collected for first statistic.
2. When compared with Threshold value, if Threshold type is percentage, for the associated statistic (second statistic) data will be collected.
3. Both will be divided and result multiplied by 100, thus giving a percentage.

The notification that you receive when the collected value exceeds the Threshold value is in the form of a **Threshold Event**. An event is an occurrence of some action. Hence, whenever the Threshold value is exceeded, a Threshold event will be generated, which will be handled by AlliedView NMS Fault module. Refer to the *NMS User Guide* for viewing events. Also, every Threshold event is associated with a Severity to denote the criticality of the situation. For example, a severity of Critical should indicate that immediate attention is needed on data collection.

You can associate multiple thresholds with a single Statistic. Doing so allows you to control every value collected. For example, you can say if the collected value is above 10, the severity is minor. If the collected value is above 20, severity is major. In such a case the following will happen:

1. Until a threshold reaches its reset value, it will be in that severity state itself. As soon as it reaches the reset value, the threshold gets reset and waits for the collected data to again exceed its limit.
2. If another threshold exists of lower severity and if the collected data falls in its limits then that threshold will generate the message.
3. If a threshold exist with higher severity, the higher severity threshold will take precedence and its message will be displayed. The threshold with lower severity loses its importance and will not be generated until the threshold with a higher severity reaches reset state.

8.4.2 Add Threshold

To add a Threshold, access the Configuration Collection view, and then select **Edit -> Threshold -> Add Threshold**. The following figure appears, showing three tabs, one for each type of threshold. Type **long** is the default tab. The tabs are for long, string, and percentage properties. Refer to the following figure.

FIGURE 8-6 Threshold Properties (type long)

The following table lists the properties for the threshold form.

TABLE 8-5 Properties for Thresholds

Property	Description
Name	Any action in a network can be captured and an appropriate name can be given to the event generated on such actions. For example, when ManagedObjects are added into the database an event can be generated. This event may be named as AddMOevent . Similarly generated Threshold events can be named which is decided by the Administrator. This name will be used by the Fault module for Event handling and for appropriate notification.
Severity (Trigger Severity)	String to emphasize the importance of the event generated when the Threshold value is exceeded. By default, the following severity strings have been defined Critical, Major, Minor, Warning, Clear.
Category	By default, the word Threshold is used for identifying Threshold events.

TABLE 8-5 Properties for Thresholds (Continued)

Property	Description
Threshold Type	Type of Threshold value you are going to specify. Possible values are Max, Min or Equal: Max - If Collected value exceeds Threshold value, an event will be generated. Min - If Collected value is less than Threshold value, an event will be generated. Equal - If Collected value is equal to Threshold value, an event will be generated.
Threshold Value	Integer value which can be interpreted in two ways: 1. In the case of a Threshold defined for Long values, the data collected for the OID is compared with this value. 2. In the case of Percentage Thresholds, the result of (first OID / secondOID) * 100, a percentage value, is compared with this value.
Rearm Value	Integer which denotes that when the collected value (or calculated value in case of percentage thresholds) reaches the Rearm value, the violated Threshold is brought back to normal and a clear event will be generated.
Reset Severity	When the Threshold is reset, by what severity it should be denoted.
Allowed Values	String value which will be compared with the string data collected. If both match then a Threshold event will be generated. The string which you can specify here can be: - simply a string, for example router5. - a comma separated list, for example router1, router2. - using wild card characters, for example router* where * indicates any number of characters and any character.
Disallowed Values	String which will be compared with the string data collected. If both match then a Threshold event will be generated denoting a reset of Threshold. You can enter strings as specified above.
ObjectID	The Object Identifier for which data will be collected in case of PercentageThresholds. For example, 2.2.1.16.1.
Object ID Type	Type of Data identifier whether it is Node, Interface or Multiple.
Message	String that will be displayed in the Event panel of Fault module when Threshold value is exceeded.
Clear Message	String that will be displayed in the Event panel of Fault module when Threshold is reset (cleared).
Send Clear	Only when this check box is checked, Clear events will be generated on Threshold reset. Otherwise the Threshold will be reset and you will not know, as no information will be displayed in Event panel of Fault module.

8.4.3 Associate Thresholds with Statistics

When Statistics are created, thresholds can be associated with them. In the Configuration Collection panel, select **Edit** -> **Modify Statistic**. The form shown in [Figure 8-4](#) appears.

1. In the first screen, check the **Advanced** checkbox.
2. Check the **Threshold** checkbox.
3. In the Threshold list text box, enter the threshold names separated by a comma.
4. Click **Modify** to make the changes. The threshold is activated immediately.

Note: If you wish stop the monitoring of the statistic (usually for a short time), uncheck the Threshold box and select **Modify**.

Note: You cannot modify the threshold values from this dialog box.

9. Setting Up Fault Management

9.1 Overview

Network Events are entities that represent the various happenings in the network devices. Events can convey general information or the current status of the devices in a network.

There are many powerful tools that allow an Administrator to control how managed objects (specific aspects of a device) report changes in their state. Through parsing and filtering, the Administrator can ensure that any change of state in a device or set of devices is reported in such a way that users can easily pinpoint the problem (or potential problem).

9.1.1 AlliedView NMS Fault Management Configuration

Note: Although the overall management area is called Fault Management, changes that explicitly result in an alarm on the Fault Management GUI (table) make up only a part of the overall Fault Management area. This is explained and shown below.

As a device or the AlliedView NMS undergoes a change, there are various mechanisms that inform the AlliedView NMS that a change has occurred. These reports pass through various software tools that process these reports and display the changes in a way that allows the user to quickly understand the nature, severity, and location of the change. Moreover, the user can edit these software tools to control the filtering and reporting format of these reports.

[Figure 9-1](#) shows the overall configuration of Fault Management, the categories of device (and NMS) changes, the software tools used by the AlliedView NMS, and the areas where the results are displayed.

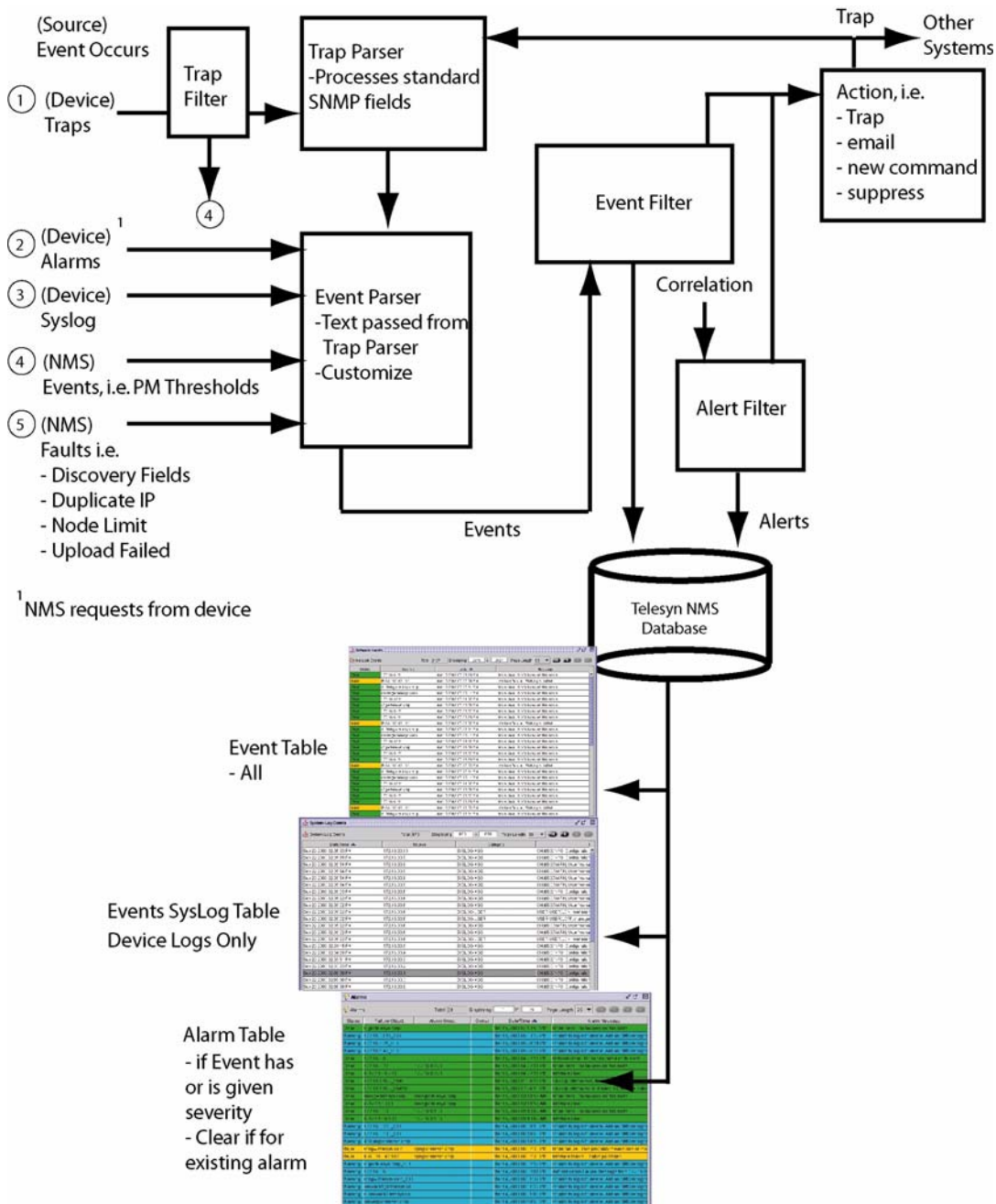

FIGURE 9-1 Fault Management Configuration for the AlliedView NMS

9.1.2 Task Overview

The following table lists the tasks that can be done at the Application interface. If you are using NMS, use the Screen Name as well to locate the relevant section. For all menu options, refer to the AlliedView NMS User Guide Appendix.

TABLE 9-1 Task List for Fault Management

Task	Form/Screen Name (if Applicable)	Section
Review Events Screen	Network Events	(9.2)
Configure Trap Parsers	Telesis Trap Parser Configuration	(9.3)

TABLE 9-1 Task List for Fault Management (Continued)

Task	Form/Screen Name (if Applicable)	Section
Configure Event Parsers	Telesis Event Parser Configuration	(9.4)
Configure Event Filters	Telesis Event Filter Configuration	(9.5)
Review Alarm Screen	Alarms	(9.7)
Alarm Propagation	Alarms	(9.8)
Configure Alarm Filters	Telesis Alarm Filter Configuration	(9.9)
Configure System Logs	(System Log Configuration)	(9.6)
Alarm Retrieval During (Re)Discovery	Retrieve Alarms	(9.10)

9.2 Event View

This Event Viewer gets displayed on selecting the **Network Events** node under **Fault Management** in the AlliedView NMS Client Tree as shown in the following figure.

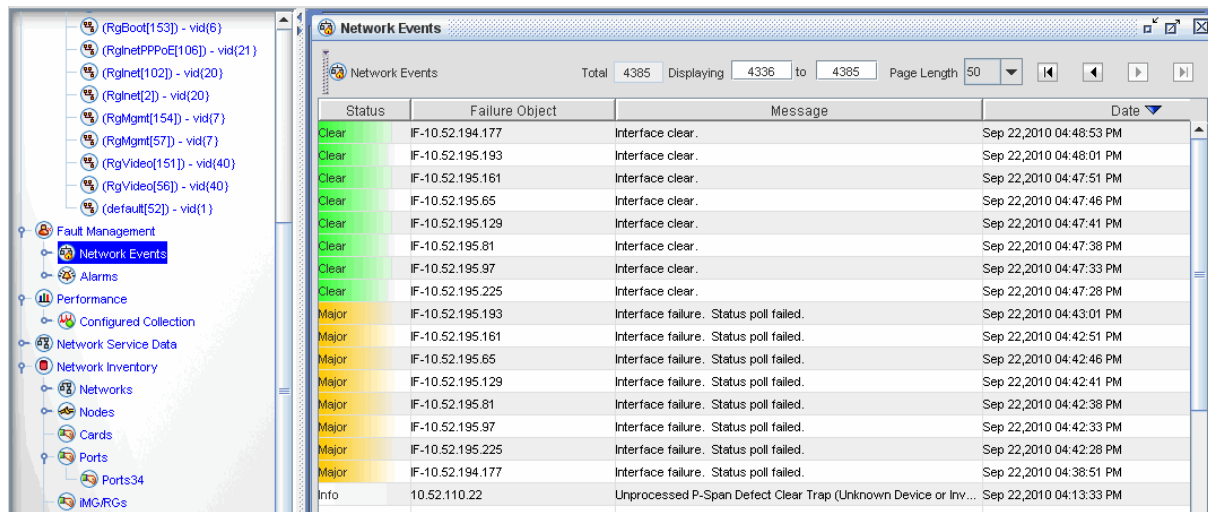

FIGURE 9-2 Network Events Main Panel

Refer to the *AlliedView NMS User Guide* for general information on navigating in the view and using the search tool.

9.3 Configuring Trap Parsers

Configuring a Trap Parser is done to create and refine the information received from a trap (a specific unsolicited report by a device).

Configuring Trap Parsers can be done by using the information in the MIB to set the match criteria or defining the configuration and saving it to a file. (This requires that the MIB has been configured to include the traps. Refer to Section 11.)

Note: Trap parsers are critical to alarm correlation and should only be changed under the supervision of Allied Telesis Technical Support personnel.

To configure the Trap parser, select **Edit -> Configure -> Trap Parsers** from the main menu of the Network Events Panel.

The Trap Parser Configuration form is shown in the following figure.

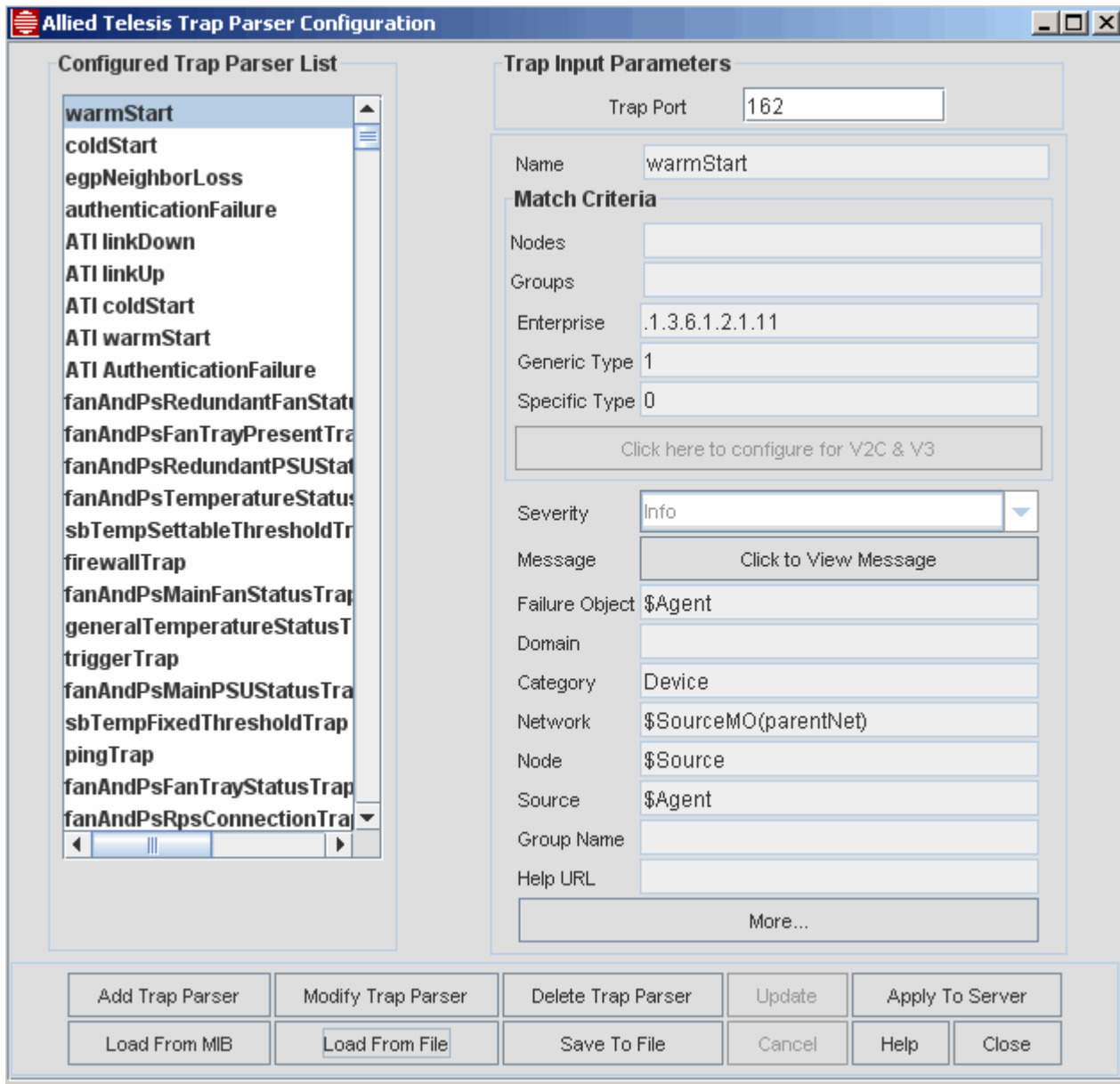

FIGURE 9-3 Trap Parser Configuration Form

Select a Trap Parser from the list to see how the fields are configured for that Trap parser. The following table describes these fields at a general level, as well as the option buttons. Many of the fields will have a variable name, discussed after this table.

TABLE 9-2 Trap Parser Configuration Form

Option	Description
Trap Port	Port that receives the trap. You must provide at least one, or the traps will not be received. More than one port can be entered, separated by commas.
Name	Name of the trap. The name should match the event.
Nodes	Specific nodes for this trap parser. Since most trap parsers are for general conditions or device types, this field is usually not used.
Groups	Grouping of nodes.

TABLE 9-2 Trap Parser Configuration Form

Option	Description
TrapOID	A TrapOID uniquely identifies an SNMP v2c or SNMPv3 trap and comes along with the Trap PDU. The TrapOID can be a match criteria. When the TrapOID has a value that starts with the Object Identifier the match criteria is met. Wildcard (*) can be used. When the Trap Object Identifier of the incoming trap must match exactly the TrapOID, put the value in brackets (<>).
Enterprise	Used to specify the enterprise OID of the SNMP v1 trap. If this field is specified, then the parser will be applied only if the trap enterprise field starts with the value you have specified. For example, when an enterprise OID is specified as .1.3.6.1.2.1.11 , then all the OID's under this tree will be matched for traps. To avoid this kind of matching, the enterprise OID value should be given in angular brackets like <.1.3.6.1.2.1.11> . In this case, only the trap with this OID will be matched. If the value is given as *, then all the OID's will be matched. The enterprise field should not be left empty.
Generic Type	Each SNMP v1 trap has a Generic type number. This number can be used for specifying the match criteria. You can specify the Generic Type (GT) number in this field, so that the trap parsers will be applied if the incoming trap has a GT value equal to the one specified in this field.
Specific Type	Each SNMP v1 trap has a Specific Type number as well. You can also use this as a match criteria for the incoming trap. When the incoming trap matches this criteria, then the trap parsers will be applied.
Severity	Severity of the resulting alarm, ranging from info to Critical .
Message	Click on the click to Edit Message button to type in what will appear in the text field of the alarm.
Failure Object	The most important field, it must reflect the actual problem.
Domain	The domain name for the Event.
Category	The category for a set of events or alerts.
Network	Network name associated with the event.
Node	Node value for the event.
Source	Source name for the event. If the status of the Managed Object is to be updated with the severity of the event, the Source should match the Managed Object name.
Group Name	The group name if alarms or events are to be grouped.
Help URL	The help file, which is this document.
More	After selecting this button you can include additional properties for the Event. This is explained in more detail below.
Add Trap Parser	Create a new trap parser with all fields editable. The Update button adds it to the Trap Parser list. If all of the fields are the same as an existing Trap Parser, an error message appears. If the name you choose already exists in a file (config directory) or the MIB (mibs directory), an error message appears.
Modify Trap Parser	Change an already existing trap parser.
Delete Trap Parser	Delete the selected trap parser. If the parser exists in the config or mibs directory, it will be deleted from the directory.
Update	Update the modified trap parser. The change will not take effect until the Apply to Server button is selected.
Apply to Server	Make the changes permanent.

TABLE 9-2 Trap Parser Configuration Form

Option	Description
Load from MIB	Loads the trap file from the mibs directory so the traps can translated to a trap parser. This is explained in more detail below.
Load from File	Loads the trap file from the conf directory. This is explained in more detail below.
Save to File	Brings up the Save <type of information> to File form. Save the trap parsers as a file. The default path is to the <code>conf</code> directory. This allows the configured trap parser to be used again and as a backup. <i>Note: When saving these files, the AlliedView NMS sets as the default directory the <AlliedView NMS Home>/state directory, so for example the file path:</i> <code>../conf/trap.parsers</code> <i>is being saved in the conf directory by going up one level from the state directory (..) and then down to the conf directory. If the user enters in the form only a file name, that file is being saved in the default state directory.</i>
Cancel	Cancels the update.
Help	Brings up this section of this document.
Close	Closes the form. If no changes were applied to the server, they are lost. If changes have been made, there is a prompt on whether to apply the changes.

9.3.1 Using Trap Values in the PDU

To help define the values for the event output, tokens are available in the incoming trap PDU. These can be used when defining the output values for the trap parser. These are listed in the following table.

TABLE 9-3 Tokens to Access the Properties of the Trap PDU

Token	Description
\$Agent	<p>SNMP V1 Traps: If the device corresponding to the agent address returned by the trap has already been discovered by Web NMS, then this token will fetch the name of the parent Managed Object, corresponding to the interface object matching the agent address of the trap received. If the device corresponding to the agent address of the trap has not been discovered, then this token will return the corresponding IP address of the agent address from which the trap has been received.</p> <p>For example, if a trap is received from an agent and if the corresponding device has already been discovered by AlliedView NMS, then the interface object will be IF-web server and the name of the parent managed object will be web server. In this scenario, \$Agent will return webserv. In case the device is not yet discovered, then \$Agent will return the IP address (192.168.1.30).</p> <p>SNMP V2c & v3 Traps: If the device corresponding to the source address contained by the trap received has already being discovered by AlliedView NMS, then this token will fetch the name of the parent Managed Object, corresponding to the interface object matching the source address of the received trap. If the device corresponding to the source address of the trap has not yet been discovered, then this token will return the IPaddress of the Source of the Trap.</p>
\$Community	This token will be replaced by the community string of the received trap.
\$Enterprise	This token will be replaced by the enterprise id of the received trap. Applicable only in the case of SNMP traps, or else replaced with a blank.
\$GenericType	This token will be replaced by the generic type of the received trap. Applicable only in the case of SNMP v1 traps, or else replaced with a blank.

TABLE 9-3 Tokens to Access the Properties of the Trap PDU (Continued)

Token	Description
\$Source	If the device corresponding to the source address contained by the trap received, has already been discovered by AlliedView NMS, then this token will fetch the name of the parentManaged object, corresponding to the interface object matching the source address of the received trap. If the device corresponding to the source address of the trap received has not yet been discovered then the corresponding IP address of the source address will be returned.
\$Specific-Type	This token will be replaced by the specific type of the received trap. Applicable only in the case of SNMP v1 traps, or else replaced with a blank.
\$Uptime	This token will be replaced by the uptime value in the received trap.
\$TrapOID	This token will be replaced by the trap OID of the received trap. Applicable only in the case of SNMP v2C traps, or else replaced with a blank.
\$*	This token will be replaced by all the variable bindings (both OID and variable values) of the received trap. for example, for the following varbinds, 2.2.1.1.221 INTEGER 30 .1.3.6.1.2.1.1.1 STRING abc 2.2.1.1.1 INTEGER 10 the result will be: ifIndex: 30, sysDescr: abc, ifIndex: 10
\$#	This token will be replaced by all the variable binding values (only variable values and not OIDs) of the received trap. For example, for the following varbinds, 2.2.1.1.221 INTEGER 30 .1.3.6.1.2.1.1.1 STRING abc 2.2.1.1.1 INTEGER 10 the result will be: 30, abc, 10
\$N	Here N is a non-negative integer. This token will be replaced by the (N+1)th SNMPvariable value in the variable bindings of the received trap. The Index N starts from 0. For example, for the following varbinds, 2.2.1.1.221 INTEGER 30 .1.3.6.1.2.1.1.1 STRING abc 2.2.1.1.1 INTEGER 10 and for %1 , the result will be: abc
@*	This token will be replaced by all the OID labels in the variable bindings of the received trap. Example: For the following varbinds, 2.2.1.1.221 INTEGER 30 .1.3.6.1.2.1.1.1 STRING abc 2.2.1.1.1 INTEGER 10 the result will be: ifIndex: sysDescr: ifIndex
@N	This token will be replaced by the (N+1)th OID value in the variable bindings of the received trap. The index count starts from 0. This token will be replaced by the (N+1)thOID label in the variable bindings of the received trap. The index starts from 0. For example, for the following varbinds, 2.2.1.1.221 INTEGER 30 .1.3.6.1.2.1.1.1 STRING abc 2.2.1.1.1 INTEGER 10 and for @1 , the result will be: sysDescr
\$IP-Source	This token will be replaced by the IP address corresponding to the source address of the trap received.
\$IP-Agent	This token will be replaced by the IP address corresponding to the agent address of the trap received.
Special Purpose Tokens - The associated Managed object should have been discovered already by Web NMS for using the following special purpose tags (or tokens). This is applicable for all special purpose tags (or tokens) listed in this section.	

TABLE 9-3 Tokens to Access the Properties of the Trap PDU (Continued)

Token	Description
\$AgentMO	This tag (or token) facilitates the accessing of managed object properties. The tag can be used to access any properties of the Parent managed object for the interface object corresponding to the agent address of the received trap. (Fetching the Managed Object is similar to the \$Agent tag mechanism). For example, if the user wants to access the “pollInterval” property of the Parent Managed object corresponding to the agent address of the received trap and then assign it to some property of the Event object generated, the user should specify the tag as \$AgentMO(pollInterval) against the specific property of the Event. Usage:- \$AgentMO(PropertyName)
\$IF-AgentMO	This tag is similar to \$AgentMO, except that the properties of the interface managed object’s corresponding agent address of the received trap could be accessed using this tag. In the case of SNMP V2c traps, it will be exactly the same as \$IF-SourceMO. Usage:- \$IF-AgentMO(PropertyName)
\$IF-Agent	This is similar to \$Agent, except for that it results in the interface managed object name corresponding to the agent address of the trap received. In the case of SNMP V2c traps, it will be exactly the same as \$IF-Source. Usage:- \$IF-Agent
\$SourceMO	The tag can be used to access any properties of the Parent managed object for the interface object corresponding to the source address of the received trap. (Fetching the Managed Object is similar to the \$Source tag mechanism). For example, if the user wants to access the “pollInterval” property of the Parent Managed object corresponding to the source address of the received trap, in order to assign it to some property of the Event, the user has to specify the tag as \$SourceMO(pollInterval) against the specific property of the Event. Usage:- \$SourceMO(PropertyName)
\$IF-SourceMO	This tag is similar to \$SourceMO, except that the properties of the interface managed object corresponding to the source address of the received trap could be accessed using this tag. Usage:- \$IF-SourceMO(PropertyName)
\$IF-Source	This is similar to \$Source, except that it results in the interface object name corresponding to the source address of the trap received. Usage:- \$IF-Source

9.3.2 Loading from a MIB

To load a MIB with defined traps that can then be translated to trap parsers, click **Add Trap Parser**, and then click **Load from MIB**. A dialog box prompts for the filename of the MIB.

The filename path should be relative to the <Web NMS Home>/servlets directory. If the MIB depends on (imports) other MIB files, they should be listed in order, separated by spaces.

For example, if A-MIB imports B-MIB imports C-MIB (all files in the <Web NMS Home>/mis directory, then enter the following:

```
Input: ../mibs/C-MIB ../mibs/B-MIB ../mibs/A-MIB
```

The trap parsers are created only from the last MIB file. Clicking **Create Parsers** will load the MIBs and create trap parsers from the last file. You can then set the event object fields for the created parsers. If no severities are specified, the default **Info** will be used.

9.3.3 Loading from a File

To load a set of trap parsers previously saved by the **Save to File** button and add them to the list of Trap Parsers, click **Load From File**, and in the dialog box, enter the filename on the server that contains the trap parsers. The trap parsers are usually stored in <Web NMS Home>/conf/trap.parsers. Clicking **Load** will load the trap parsers from the file. Parsers with the

same matching criteria are replaced. If the Trap Parser name is the same, there is confirmation prompt to replace the existing one. Once loaded, the **Apply to Server** button makes the changes permanent. The trap parsers in the `trap.parsers` file will load the next time the AlliedView NMS server starts.

9.3.4 Reordering the Trap Parser List

The list for Trap Parsers is in the order the AlliedView NMS tries to find a match. To reorder the list, select a Trap Parser and drag it up or down the list.

9.4 Configuring Event Parsers

9.4.1 Overview

When an event arrives into the AlliedView NMS, the event parsers list is checked to see whether the incoming event satisfies the match criteria of the event parser. If the event parser matches, the event is passed through the corresponding event parser. The outgoing event from the parser is then matched with the remaining set of parsers (if any, in sequence). If there are any matches, then the event will be passed through those parsers. This process will continue till there are no parsers left to be scanned.

In the Configured Event Parsers List, the user can view the list of currently configured event parsers. On clicking any of them, the corresponding details will be listed. By default, the event parsers that are saved in the file `event.parsers` under `<AlliedView NMS Home>/conf` directory will be loaded automatically when the server is restarted and then displayed in the Configured Event Parsers List.

Note: Event parsers are important to alarm correlation and should only be changed under the supervision of Allied Telesis Technical Support personnel. If you delete any of those you made degrade or destroy existing NMS functionality.

To configure the Event parser, select **Edit -> Configure -> Event Parsers** from the main menu of the Network Events Panel. The Event Parser Configuration form appears, as shown in the following figure.

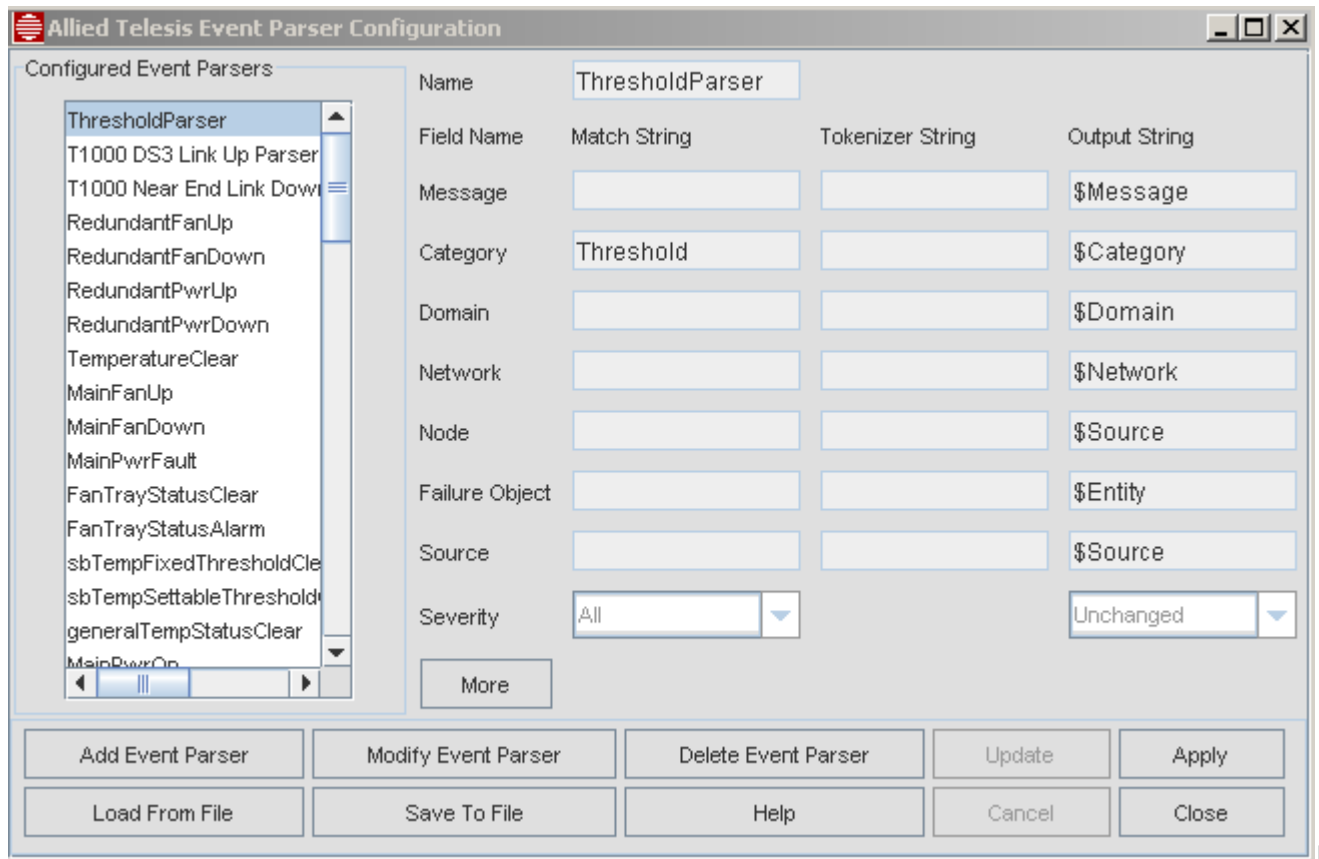

FIGURE 9-4 Event Parser Configuration Form

9.4.2 Setting Event Parsers

Select an Event Parser from the list to see how the fields are configured for that Event parser. The following table describes these fields at a general level, as well as the option buttons. Many of the fields will have a variable name, discussed after this table.

TABLE 9-4 Event Parser Configuration Form

Option	Description
Name	Name of the event. The name should match the type of event.
Match String	<p>The match criteria determine whether the Event will be parsed by the given Event parser or not. If a field is left blank, it is automatically matched. Otherwise all fields (AND condition applied) must match the input event.</p> <p>To specify a match criteria, the following may be used in expressions.</p> <p>Wild Card - Asterisk (*): To signify match 0 or more characters of any value. e.g., *Failed* will match any String with <i>Failed</i> somewhere in it.</p> <p>Negation - Exclamation (!): This can be used at the start of a field, to specify exclusion of Events matching the succeeding expression. e.g., !Failed will exclude Strings with Failed anywhere in them.</p> <p><i>Note: Expressions like *Failed, Fai*d and * have the expected meanings in the match criteria.</i></p>

TABLE 9-4 Event Parser Configuration Form (Continued)

Option	Description
Tokenizer String	<p>Allows you to break up the input field into a series of tokens that can then be used in the output Event object. The tokenizer definition is a string with the tokens represented by \$1, \$2, etc. Only positive integers are allowed following '\$'.</p> <p>Example:</p> <p>Consider the case, where you expect an event message text string as: <i>Line Card 31 failed on Shelf 54: No Response - (Match String).</i></p> <p>The Line Card Number (31) and the Shelf Number (54) may be required while defining other properties of event, so they will be tagged as tokens with a token number. <i>Line Card \$1 failed on Shelf \$2: No Response - (Tokenizer String).</i></p> <p>After such tokenization, the token number is used in the output event definition. Specifying \$text\$1 for any field in the output event definition will be replaced with the value 31, while specifying \$text\$2 will be replaced with 54.</p> <p>Note: <i>To identify the Replaceable parameter of a specific field, the token number should be preceded by the field, for example \$text\$1 indicates the first tokenized string of the field Message.</i></p> <p>The tokens of any field can be used in any other field, provided this Note is followed.</p>
Output String	<p>The output of the event parser is an Event object, which will be the modified instance of the incoming event. The attributes of the Event object are defined by what are specified in the event parser, so it is necessary to select correct values for important attributes such as failure object (affected Entity), severity, and message text.</p> <p>The properties that should remain unchanged must be specifically noted by placing a dollar followed by that property name. For example, if the <i>text</i> field should not be modified, then the value <i>\$text</i> should be entered in the Output String.</p> <p>When specifying the output values in the definition column, to use the values of the incoming event properties, you should specify the exact property name (case sensitive) with a prepended \$. For example to use the event property <i>source</i>, the definition should be <i>\$source</i>. If the particular property has been tokenized and if user intends to use the value of the token, then the format should be \$propertyname\$N, where N should be the count of the token starting with 1.</p> <p>When it is necessary to deliberately have a null value for a specific property of the Output Event, then the Output String for that property should be left blank.</p> <p>The default properties of event that can be used in the definition column following \$ are: <i>category, domain, entity, groupName, helpURL, network, node, source, severity, text, WebNMS</i>. Apart from the listed default properties of the event, user property names can also be used.</p> <p>For the list of the various Event Properties and their description, refer to Event Properties.</p>

TABLE 9-4 Event Parser Configuration Form (Continued)

Option	Description
More	<p>Configure additional criteria based on other properties of the event, which could also include the User properties, apart from the given default set of Event properties.</p> <p>In the first column of the dialog, specify the “name of the property”, which could be any valid property of the Event including its user property. While giving the name, ensure that the name has the same case as given in the event properties. The second column specifies the matching criteria. In the third column, user can specify the pattern in which the incoming event property has to be tokenized. The fourth column is for defining the output value of the corresponding property in the resultant event.</p> <p><i>Note:</i> You should note that if a criteria is configured, based on the Event user property and if no definition is given against that property, then the user property will be dropped in the resulting Event. The event properties id and time are not configurable using the event parsers. These fields will be copied to the values as that of the incoming event object.</p> <p><i>Note:</i> When user properties are added to events, they can be used in additional event parsers or custom views.</p>
Add Event Parser	<p>Add a new Event parser. All the fields in the screen are editable. Ensure the name is unique. If the entered name matches the existing one, then an error message will pop up with the message “Event parser of the given name already exists. Should that be replaced?” Clicking “Yes” will overwrite the existing criteria. Clicking “No” will quit the add operation.</p>
Modify Event Parser	<p>Modify an existing Event Parser. All fields are editable.</p>
DeleteEvent Parser	<p>Deletes the selected Event Parser. You can also click on the Event Parser and use the Del Key, or Control + Del or more than one.</p>
Save to File	<p>To reuse the configured event parsers and to save the event parser configuration as a backup. These files can later be loaded in to the same or another event manager. This will enable sharing of the event parser data by other users. When this option is chosen, a dialog window will be brought which will prompt you to enter a filename (the default being event.parsers). Enter the name of the file and choose Save option to save the trap parser.</p> <p><i>Note:</i> When saving these files, the AlliedView NMS sets as the default directory the <NMS Home>/state directory, so for example the file path:</p> <p style="text-align: center;">../conf/event.parsers</p> <p>is being saved in the conf directory by going up one level from the state directory (..) and then down to the conf directory. If the user enters in the form only a file name, that file is being saved in the default state directory.</p>
Load from File	<p>To load a set of event parsers previously saved with the Save To File option and add them to the existing list of event parsers. This option brings up a dialog box to specify the filename on the server, which contains the event parsers. Choosing the Load option will complete loading event parsers from the specified file. The parsers with the same matching criteria as that of the existing ones will be replaced with the new ones.</p>
Update	<p>Update the modified Event Parser. The change will not take effect until the Apply to Server button is selected.</p>
Apply to Server	<p>Makes and changes permanent.</p>
Cancel	<p>Cancels the update.</p>

TABLE 9-4 Event Parser Configuration Form (Continued)

Option	Description
Help	Invokes this table.
Close	Closes the form. If no changes were applied to the server, they are lost. If changes have been made, there is a prompt on whether to apply the changes.

If the event object contains the trap pdu information, you can make use of the trap pdu information while defining the output events. The methodology of using the properties of the trap using symbolic notations is similar as in Trap Parsers, except for the following:

- To access the values of the SNMP OID in the SNMP Variable bindings, the notation should start with % and not with \$ as in trap parser.
- To access the SNMP OID in the SNMP Variable bindings, the notation should start with @ which is same as in trap parser.

The values of the trap pdu can be used in any of the columns, except in Tokenizer in the parser defined.

Note: If the trap pdu symbolic notation, such as %Agent, is used in the property column (while configuring Additional Criteria) when the value has also been tokenized by specifying a tokenizer string, then to refer to a token of this field use the notation as \$%Agent\$N, where N specifies the count of the token to be used.

9.4.3 Relationship Between User Properties and Custom Views

As explained in Table 9-4, user properties can be added using the Event Parser form and clicking the **More** button. (They can also be added by Allied Telesis software extensions.) These can then be used in additional event event parsers or custom views

Note: When defining properties for nodes, include the properties displayed on the last page of the **Managed Object Properties Form**.

For Event Custom Views, refer to the NMS User Guide, Section 9.

For Alarm Custom Views, refer to the NMS User Guide, Section 9. Note that for custom alarm views only one user property, **sysLocation**, is available. This is explained in the User Guide.

9.4.4 Setting up a SYSLOG Event to Create an Alarm

By using the Event Parser Configurator, the user can parse a SYSLOG event so that an alarm is produced. This can be useful if certain events, such as a configuration change on the a device, need to be highlighted.

Figure 9-5 shows how a SYSLOG that includes the string “Configuration Updated” can be set. The user would bring up the Event Parser Configuration window and **Add Event Parser**, in this case *ConfigChangeSyslogParser*. The Category is SYSLOG, and the Severity for the Output String is Major. (SYSLOG events have no severity level on the Match String and so the Severity is set to All.)

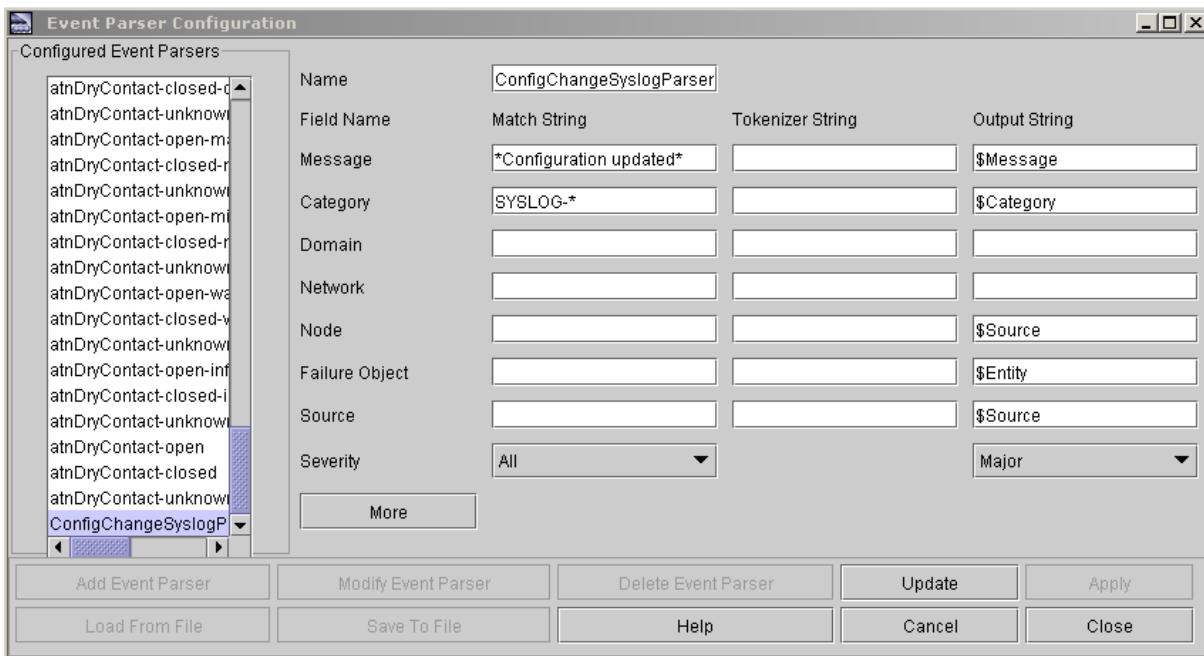

FIGURE 9-5 Setting the Event Parser to Produce Alarms for SYSLOG

The usual scenario would be the device in the Physical Network view would show the device has a major alarm. Right clicking **Alarms/Events -> Alarms** on the affected device would show [Figure 9-6](#). (This would also show up in the Events view as a network event.). The user could then double click the alarm row to further process the alarm, or **Edit -> Clear** to clear the alarm.

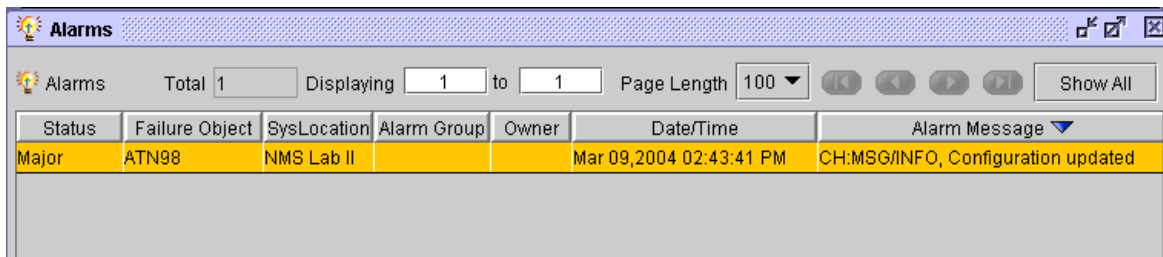

FIGURE 9-6 Alarm Produced as a Result of Configuring Event Parser

9.4.5 Changing Severity of Default Events (i.e. Status Update Failure)

The default Event Parser Configuration Form allows the user to view and modify the events that are generated by the devices. As explained in [9.4.1](#), these events have attributes (especially the alarm level) that should not be changed unless with consultation with Allied Telesis personnel.

For default events (such as status update failure), the severity of the event is already set, but can be changed by creating an Event Parser that outputs a different Severity Alarm. Following is an overview of status update and the steps to change the severity of a status node failure from Major to Critical.

9.4.5.1 Overview

The AlliedView NMS periodically tests connectivity to all managed devices by polling their interfaces. By default, the period is 300 seconds, which can be modified with the Managed Object Properties dialogue (by changing the pollInterval parameter).

By default, when connectivity is lost a major event is created, which in turn generates a major alarm. This example shows how to make the event critical instead of major.

The process involves creating an Event Parser that examines all events, identifies the ones pertaining to lost connectivity, and changes their severity from Major to Critical.

9.4.5.2 View the Default Status Failure Event

1. Disconnect a device, which will produce the Event Node Failure.
2. Select the device and click on Update Status to force a default event to occur.
3. Go to the device's event viewer to see the list of created events. Refer to [Figure 9-7](#).

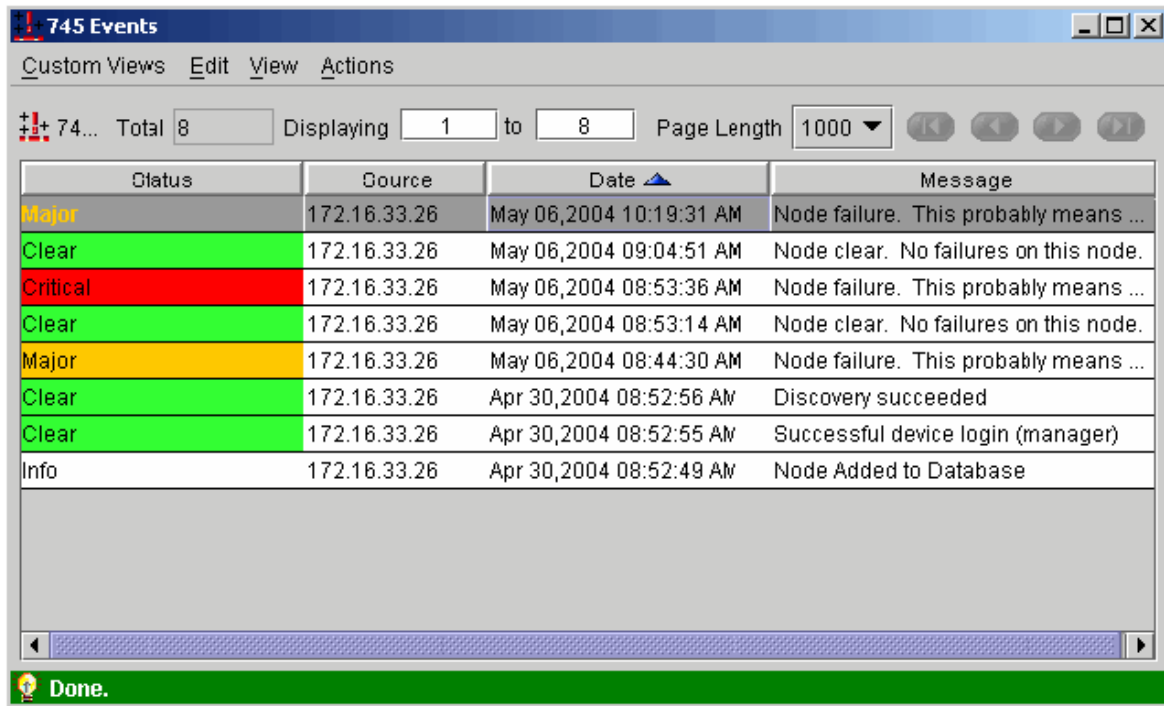

FIGURE 9-7 Viewing Major Level Severity for Node Failure Event

4. Double-click the major event and view its details. Refer to [Figure 9-8](#).

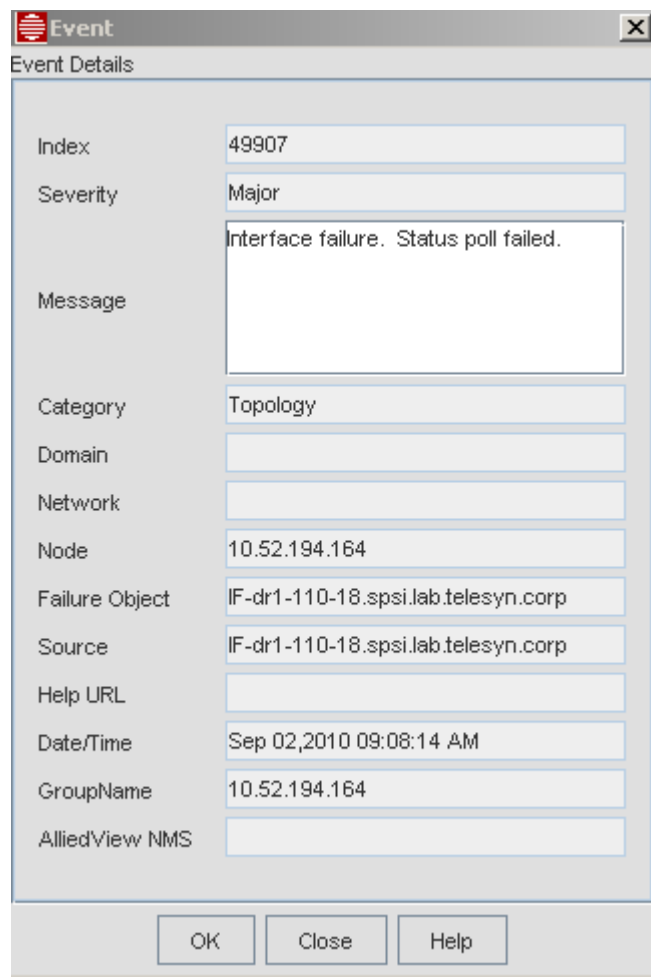

FIGURE 9-8 Viewing Object Details

5. Copy the message text (using `ctl-c`) so the text can be used in the new event parser to identify events of this type.

9.4.5.3 Bring up the Event Parser Configuration Dialog

From the event browser, select **Edit -> Configure ->Event Parsers**. The Event Parser Configuration Form will appear, as was shown in [Figure 9-4](#).

9.4.5.4 Configure the Event Parser

1. Click on Add Event Parser. The fields are now editable.
2. Give the Event Parser a name (in this example, **UpdateStatus**).
3. Enter the copied Message Text into the Message Match-String field (using `ctl-v`)

Note: Leave the Message Output-String unchanged if you want to use the same message or replace it with your own message text

4. Select Severity Match-String as "Major" and then Severity Output-String as "Critical".
5. Refer to [Figure 9-9](#), which shows the message copied in, and the Output String Severity being changed to Critical.

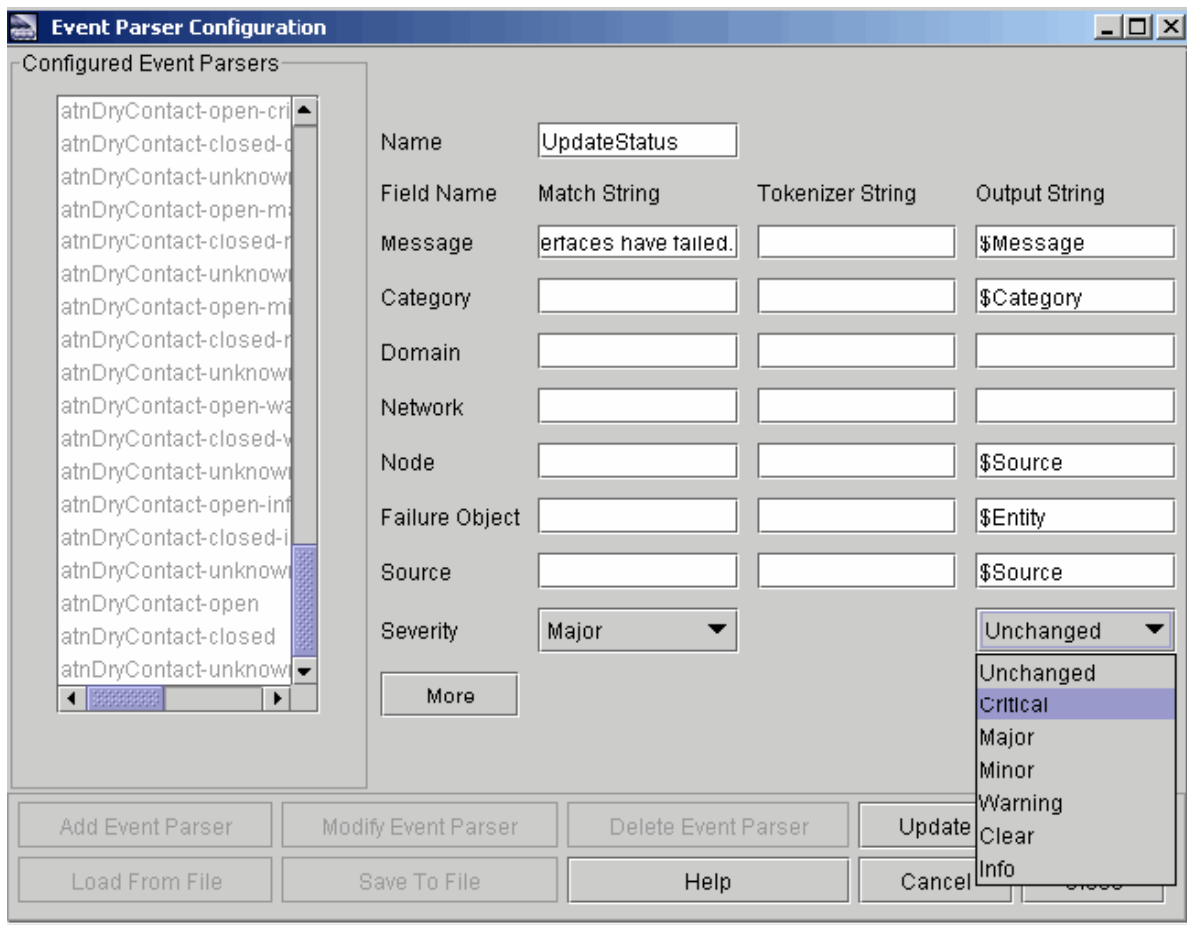

FIGURE 9-9 Creating an Event Parser and Changing the Severity

Note: The Match Strings are used to identify which events you want to change. The Output Strings say how to change those events. In this case we're changing all those that match the existing message text exactly.

9.4.5.5 Limit to a Specific Device Type

If you want to you can restrict this modification to one device type. In this example it will be the AT-AR745.

1. Select **More**, and enter “type” for the Field Name and “AT-AR745” for the Match String. (Device type names are available from the Manage Object Properties dialog).
2. Leave the other fields blank, as shown in [Figure 9-10](#).

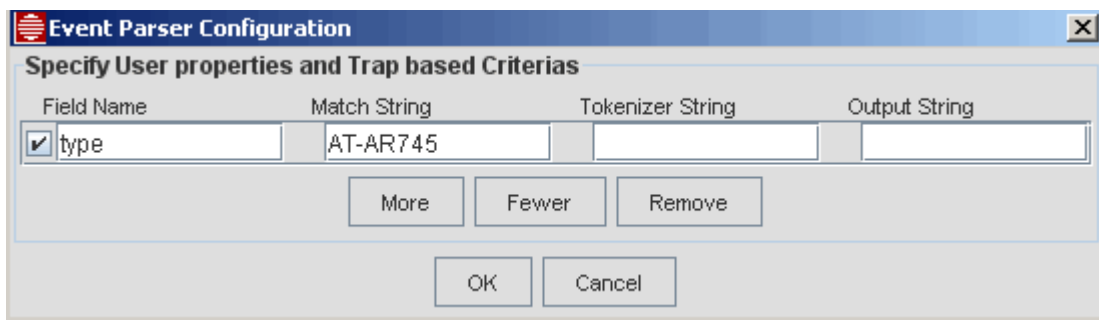

FIGURE 9-10 Making an Event Parser Device Specific

3. Click on the tic box, and then OK to add the type criteria.
4. The Event Parser Configuration Form is now the only form that is on the screen. Click on **Update**, **Apply**, and **Close**.
Now only AT-AR745's when disconnected will go critical and all the others will still be major.

9.4.5.6 Ensure the Event Parser is created

1. Select **Edit -> Configure ->Event Parsers** again.
2. The Event Parser Configuration Form will appear and will include the new Event Parser.

9.4.5.7 Test the New Event Parser

1. Delete existing alarms for the device.
2. Click on Update Status, and see the color change to red, as shown in [Figure 9-11](#).

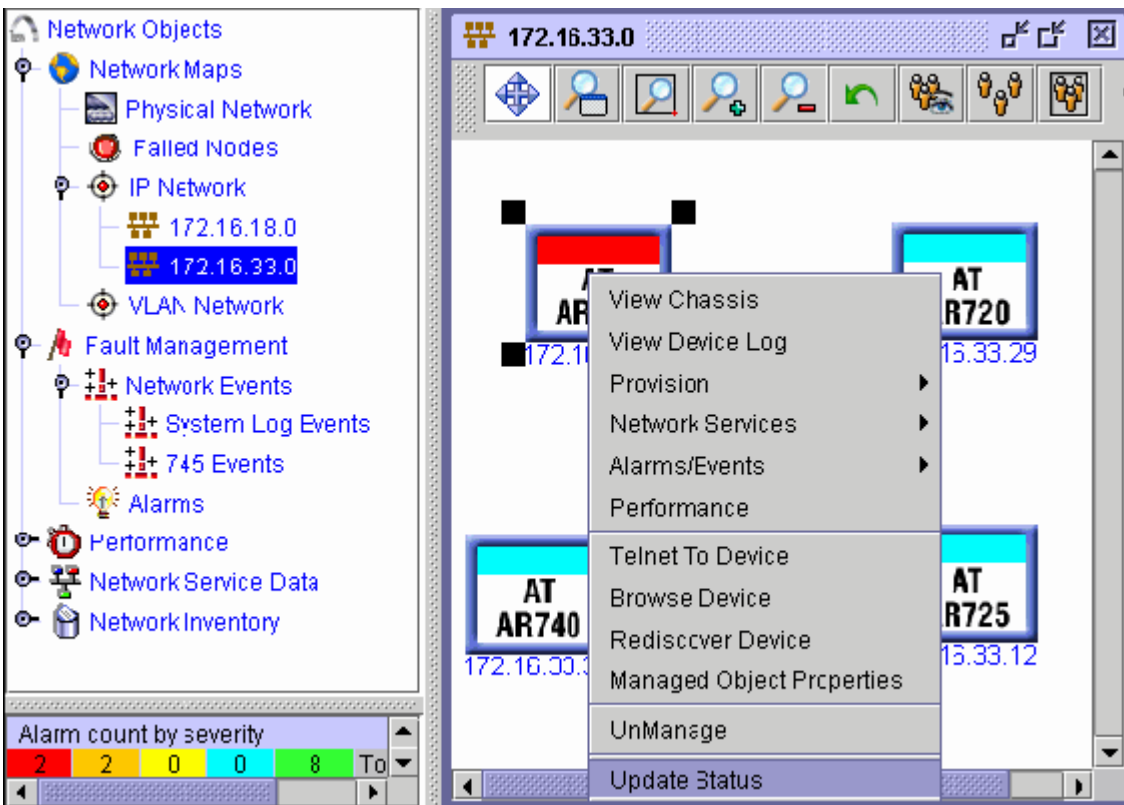

FIGURE 9-11 Testing the Changed Severity for the Event Parser (now Critical)

3. If it changed to green instead of red, either connectivity was re-established while you were creating the Event Parser, or you accidentally selected Clear on the Severity Output-String where you meant to select Critical.
4. If it goes to Orange, you misspelled the Message text, you selected Major instead of Critical, or you misspelled the type name.

Note: A critical event will also be generated for the network to which the failed device belongs.

9.4.5.8 Delete the Event Parser (if non-default behavior no longer needed)

To delete the new Event Parser (and return to the default behavior), go back to the Event Parser Configuration window, select the parser you added, click on **Delete Event Parser**, **Apply**, and then **Close**.

Note: As mentioned in [9.4.1](#), there are a number of pre configured event parsers already defined by AlliedView NMS. If you delete any of those you may degrade or destroy existing NMS functionality.

9.4.6 Changing Severity of Port-based Alarms

Two attributes for the Event object are PortProfile and Customer ID. Using these attributes, the administrator can configure an Event Parser that can filter an Event that includes these attributes and changes the default priority.

The following figure shows these two attributes that appear when the user double-clicks a port alarm and the

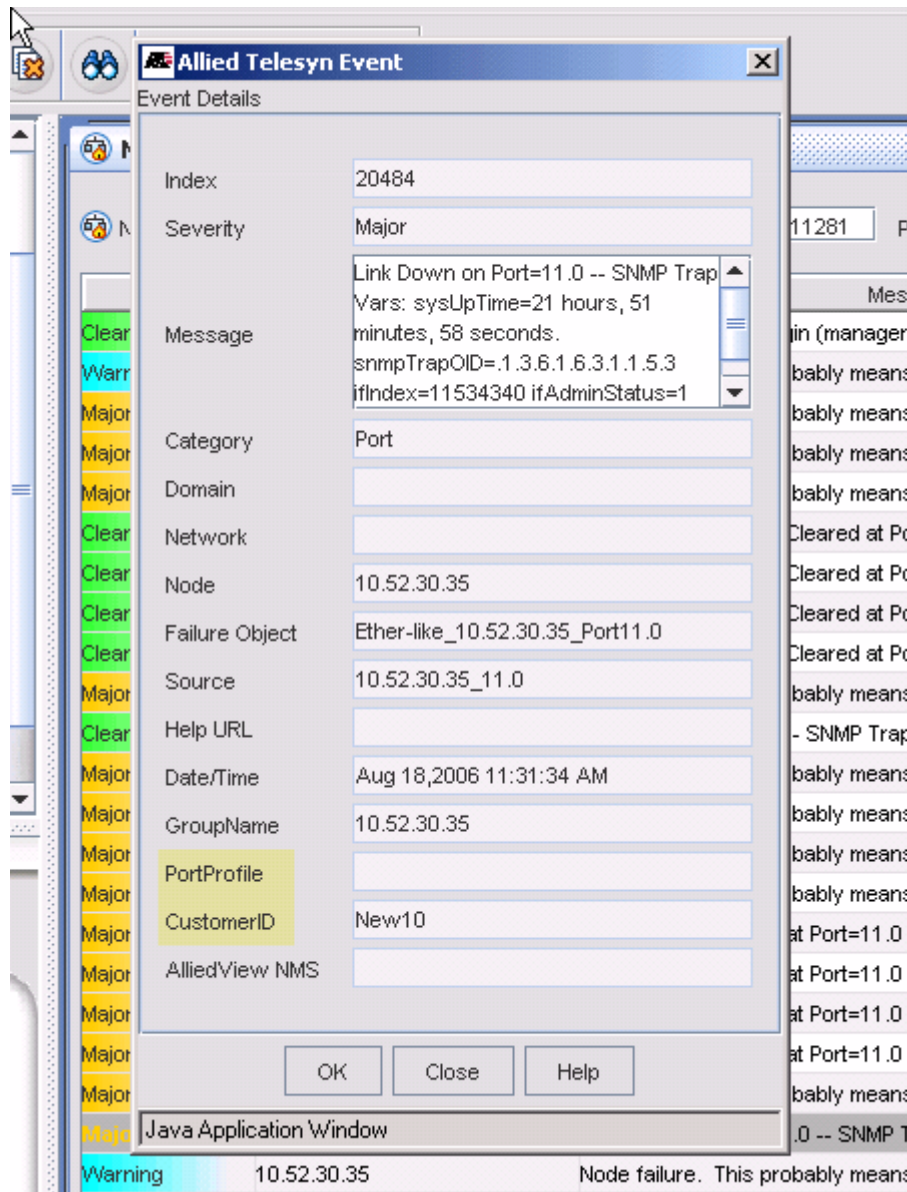

FIGURE 9-12 Object Properties for Port Alarm

By configuring the Event parser, the user can take certain events and control how they are processed, including the severity of the alarm. For example, ports can be given Profile Names that match various businesses, such as BusinessA, BusinessB, etc. In the Event Parser, Events with the Message Link Down can have a criteria set so that portProfile matches Business*. In the Output String, the Severity can be changed from Info to Major. Refer to the following figure.

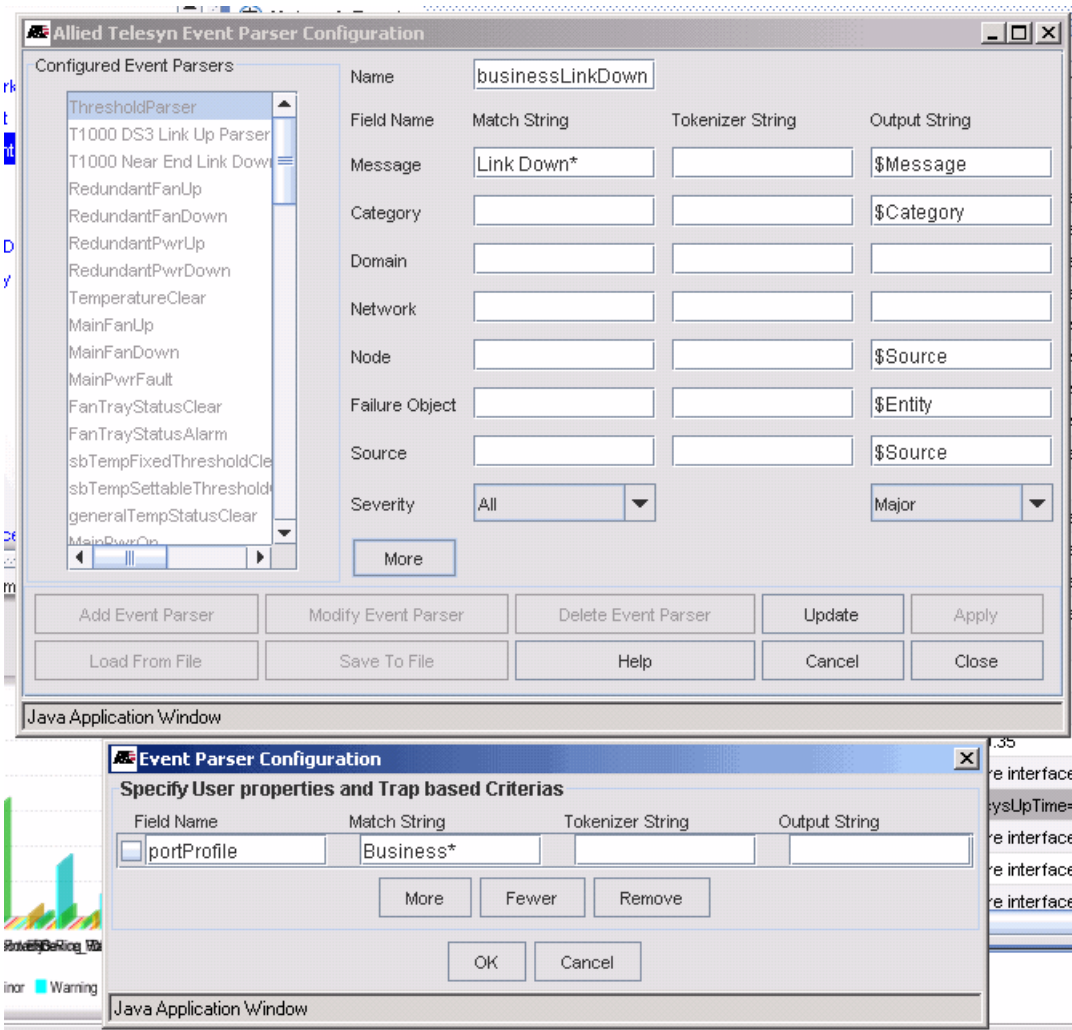

FIGURE 9-13 Configuring Event Parser with portProfile Property

9.5 Configuring Event Filters

9.5.1 Overview

Event Filters provides a way to setting a matching criteria to filter events and then configuring an action (such as an email) for these events.

Select *Edit -> Configure -> Event Filters* from the main menu of the Network Events Panel.

The **Event Filter Configuration** form appears, as shown in the following figure.

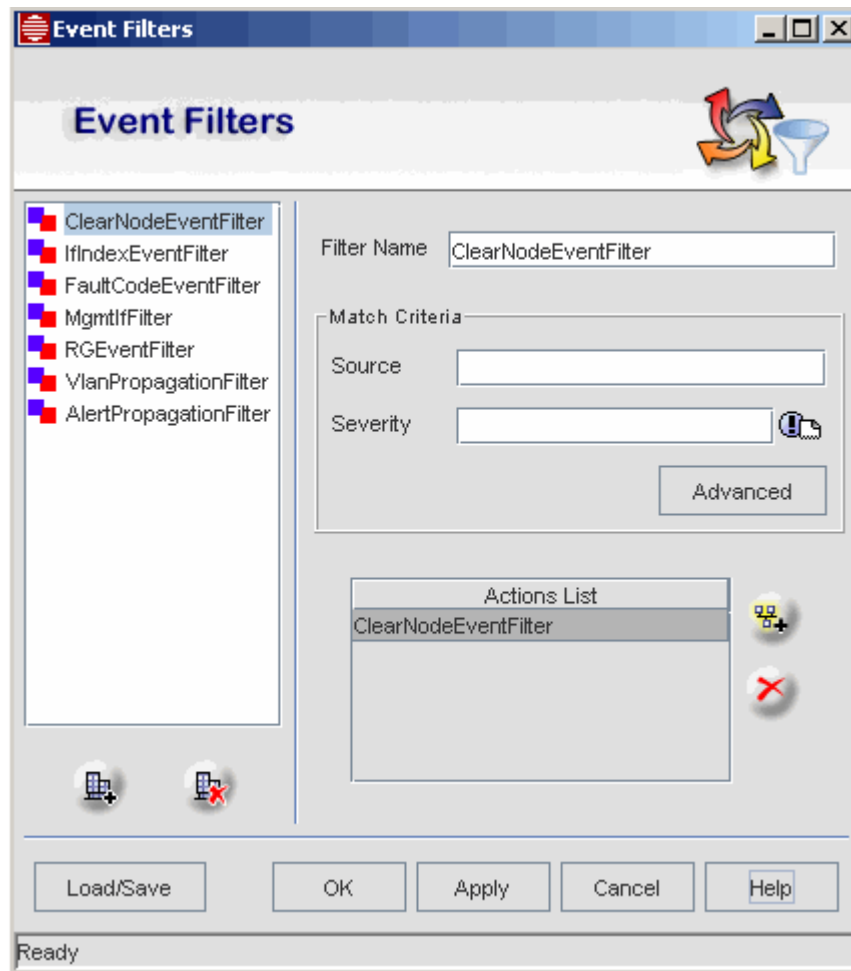

FIGURE 9-14 Event Filter Configuration Form

9.5.2 Setting Event Filters

The user can add, modify, or delete an Event Filter from the left side of the form. Refer to the following table for all options.

TABLE 9-5 Event Filter Configuration Form

Option	Description / Fields
Filter Name	Name of the filter. This field matches the filter chosen in the Configured Filter List.
Match Criteria (Click on Advanced for others)	<p>The criteria for the event are as follows:</p> <ul style="list-style-type: none"> • Severity - Specifies the match criteria based on the severity of the event (Critical, Major, etc.). • Message - The message specified in this field will be matched with the message of the incoming event (Interface failure, Status Poll failed, etc.). • Category - This is a property of the event object which could hold a category name to which the event belongs. This is used for better organization of events. • Domain - This is a property of the event object which could hold any domain-specific information. The information may either be based upon the physical location or the functional / logical categorization of the source of the event. The domain name of the event can be specified to display events of a particular domain. • Network - Holds the information about the network to which the source of the event belongs. Using this criteria, events belonging to a particular network can be displayed. • Node - Holds any additional information about the source of the event. Event filters can be specified for events that have the name of the node as specified in this field. • Entity - Stores information about the exact device in which the problem has occurred. • Source - Holds the information about the source of the event. Events matching a source can be filtered out using this field.

TABLE 9-5 Event Filter Configuration Form

Option	Description / Fields
Setting Match Criteria	<p>Determines whether the incoming event should be filtered or not. If a field is left blank, it is automatically matched. The condition for the event filter to be applied is that all the match criteria specified should be satisfied. If one criteria fails, the filter will not be applied.</p> <p>The following expressions can be used, while specifying the match criteria.</p> <ul style="list-style-type: none"> • Wildcard - Asterisk (*): A match of 0 or more characters of any value. For example, “Failed*” will match any string starting with Failed. Expressions like *Failed, Fai*led*, or * can be used which have relevant meaning. • Negation - Exclamation (!): Used at the start of the field to specify exclusion of events matching this expression. For example, !Failed will exclude strings starting with “Failed”. • Separator - Comma (,): Multiple values can be specified for a single match criteria for separating them with commas (a logical OR). For example, Critical, Major will match a string which is either Critical or Major. For another example, if all the objects with names starting with "abc" or "xyz" are required, then property key -name and value abc*,xyz* is given • Comma (,) with !: When used together, this will match the string by using a logical AND. For example, the property key-name of *xyz,!abc* must match all names that end in xyz AND begin with abc. • && (Double Ampersands): This is also used for searching objects where a single value should be matched with many patterns. For example, if all the objects with names starting with either "abc" or ending with "xyz" are required, then property key -name and value abc*&&*xyz is given. • \ (Back Slash): This is used when the name of the object itself contains a comma. This character is called an escape sequence, since it avoids searching of the objects, as if it were two different names. For example, if an object with name "a,b" has to be searched, then the property key - name and the value a\b is given. • <between>"value1" and "value2": This is used to get objects with some numeric values within a specific range. For example, if object names with poll interval value ranging from 300 to 305 is required, then the property key - pollinterval and the value as 300 and 305 is given. Note that the first number is smaller than the second number. Only the values in between the given values, including the limits, will be matched.
More Properties	<p>Specifies additional match criteria based on the properties of com.adventnet.nms.eventdb.Event object including Userproperties. While specifying the additional criteria, care has to be taken to specify only those properties that are in the event object. (The name should match exact case in the event object.) Apart from the default properties shown in the configuration UI, you can add Event's base properties as match criteria, such as groupname, helpURL, id and time. Thus the More option serves for both the Event's base properties as well as the user properties.</p>
Add Filter Icon	<p>Allows a new Filter Name to be used.</p>



TABLE 9-5 Event Filter Configuration Form

Option	Description / Fields
Delete Filter Icon 	Allows a Filter Name to be deleted.
Update Filter	Updates the Event Filter so it is ready to be applied to the NMS server.
Cancel File	Cancels any changes made.
Apply	Makes changes to the server.
Help	Brings up this section of the User Guide.

9.5.3 Setting Event Filter Actions

At least one action needs to be associated with the incoming filtered event. For an event filter, click on the **Add** button under filter action to add one of the action Types:

- **Suppress Action:** These filter actions allow you to suppress events that matches the filter criteria, either altogether or multiple events of the same type within a given interval.
- **Send Trap actions:** These filter actions allow you to send SNMP V1 traps for events matching particular filter criteria. The traps can be configured to have event data as specified by you. It can be configured to be sent to any desired host.
- **Send Email actions:** These filter actions allow you to send an email for events matching particular filter criteria.
- **Run command actions:** These filter actions allow you to run a command on the server for events matching particular filter criteria. These can be used to send a page to someone, email or any other desired command.
- **Run your own Java class filter:** You can write your own Java code to filter events and perform actions, and configure them to be applied for events matching particular filter criteria.

The configured action can be modified or deleted, although at least one action must be configured. The Update Filter option updates all the information, while the Cancel Action option cancels any new values and disables the Action Type and Filter Action Details panels.

Table 9-6 lists the fields that appear for each Action Type

TABLE 9-6 Action Types and Associated Fields for Event Filter Actions

Action Type	Filter Action Detail	Description
Suppress Action	Suppress Action Name	Name of this action required for identification
	Suppress All	This specifies whether all events should be suppressed or only suppress events based on interval. If 'yes' is selected then all events are suppressed and if 'no' is selected then the user will have an option to specify time interval for suppressing subsequent received events matching the same criteria.
	Suppress Interval	This field is used for specifying the time interval (in seconds) to suppress subsequent events.

TABLE 9-6 Action Types and Associated Fields for Event Filter Actions (Continued)

Action Type	Filter Action Detail	Description
Run Command Action	Run Command Action Name	Name of this action required for identification.
	Run Command	This is used to specify the actual command to be executed in the NMS server machine. The command specified here should not require a shell to run unless the shell program is specified in the command. <i>Note: Some commands (i.e dir,) in release 5.0 did not require a command shell to run. In release 6.0, this has changed; all commands requiring a shell must be run within the command shell (i.e. unix k-shell /bin/sh, windows 2000 cmd.exe). As an alternative, you could put the commands in a shell script and then run the script that contains the commands.</i>
	Command Results	Append Output - This is one option under command results which if selected implies that the output of the command execution should be appended to the event message body. Append Errors - This is another option under command results which if selected implies that the errors of the command execution should be appended to the event/alert message body. Long messages or errors will be truncated.
	Abort After	This is used to specify the number of seconds that the command is allowed to run and if the time specified here is reached while the executed command is still running then it will be stopped. This is important because this action can block all new events while the command is executing.

TABLE 9-6 Action Types and Associated Fields for Event Filter Actions (Continued)

Action Type	Filter Action Detail	Description
Send Trap Action	Send Trap Action Name	Name of this action required for identification
	Trap Destination	This is used to specify the hostname (IP address) of the host to which the SNMP trap will be sent.
	Destination Port	The port to which the trap is to be sent.
	Trap Community	This specifies the community string of the generated SNMP trap.
	Enterprise	Specifies the enterprise OID of the generated SNMP trap.
	Generic Type	Used to specify the generic type number for the trap to be generated.
	Specific Type	Used to specify the specific type number for the trap to be generated.
	Variable Bindings List	A listing of the bound SNMP variables.
	OID Value	Enabled when Add is selected.
	SNMP Type	The SNMP variable type (STRING, IPADDRESS, OPAQUE, OBJID, INTEGER, GUAGE, COUNTER, or TIMETICKS).
	Set Value	The value to which the variable is to be set.
	Add, Update, Cancel	<ul style="list-style-type: none"> • Add - add variable. • Update - Update the variable. • Cancel - Cancel the Add/Update.
SysUpTime (secs)	The time, in seconds, since the last system restart.	
Send E-Mail Action	Send E-Mail Action Name	A name to identify this action.
	SMTP Server	A valid mail server address.
	Recipient's Address	The Address to where the email is to be sent.
	Sender's Address	The address from where the email is being sent.
	Subject	Subject of the email. This can use variables (\$) from the Filter Name if they have been specified.
	Message	Text of the email message. This can use variables (\$) from the Filter Name if they have been specified.
Custom Filter	Custom Filter Name	The name of the custom filter.
	Custom Filter Class Name	The name of the class to which the custom filter belongs.

9.5.4 Example of Setting an Event Filter Action

The following example shows how an event can be configured so that when the event matches the criteria of an event filter an email is sent. It also shows how other actions could be added, modified, or deleted.

Note: An event filter must have at least one action.

1. Click **Add** in the Event Filter Configuration panel.
2. Enter the alert filter name and the match criteria fields. If needed, Expressions can be used: wildcard (*), negation (!), and separators (.). Use the More option if needed.
3. Click  to activate the Action Type panel.
4. Click the **Send Email Action** and **New** button. This activates the Filter Action Details panel.
5. Fill in the Action Details panel.

6. Click **OK**.



To add more actions, click  and add more action types and details. Cancel any filters or actions by clicking **Cancel** as they appear in context. The resulting alert filters and actions can be reordered by drag and drop.



To delete an alert filter, select a filter from the list and then click  from the Alert Filter panel. Any associated action will also be deleted.

To load a set of alert filters from a file, click **Load From File**. A dialog box prompts for the file path to read the filters from. Click **Load** to load the filters.

To save a set of alert filters (for later use or as a backup), click **Save**. A dialog box prompts for the file path to write the filters to. Click **Save** to save the filters.

Brings up the **Save <type of information> to File** form. Save the trap parsers as a file. The default path is to the `conf` directory. This allows the configured trap parser to be used again and as a backup.

Note: When saving these files, the AlliedView NMS sets as the default directory the `<NMS Home>/state` directory, so for example the file path:

```
../conf/event.filters
```

is being saved in the `conf` directory by going up one level from the `state` directory (`..`) and then down to the `conf` directory. If the user enters in the form only a file name, that file is being saved in the default `state` directory.

If any changes are made and the window is closed without clicking **Apply**, a prompt will appear asking whether to make the changes.

9.5.5 Setting Up Event Filters for SYSLOG Events

Section 9.6 describes how to configure system logs. To configure the event filter for system logs, you set the Category field (shown in Figure 9-16) with the string “SYSLOG-” and the Event Type. For all event types that have been configured, the string “SYSLOG-*” would be entered. You would then continue to configure the type of action.

9.6 Configuring System Logs (NMS System Log Server)

Logs are indications of various changes that occur in the managed devices on a network. To assist in troubleshooting network problems and in monitoring the overall health of the network, it is important to monitor certain logs as they are received from the network devices. Proper management of these system logs (also called SysLogs), is controlled by the NMS System Log Server feature, and the feature helps in monitoring and troubleshooting your network.

Up until NMS release 11.0 SP5, this feature worked as follows:

- All SysLog messages were stored in the NMS database if enabled.
- Only events that were reported by discovered devices were processed by the NMS and stored.

In NMS release 11.0 SP5, the following changes are made:

- Incoming events from **non**-discovered devices can also be received. Since the administrator may not want syslog information to be stored on the NMS database, there is also the option for SysLogs to be stored in a local file.
- The Status Monitoring GUI has a System Log tab added to the “Application Logs” option, allowing the local file to be viewed, as well as the option to export the local file to the client’s browser or NMS server. Refer to 3.9.

The relationship between the components that provide system logs is as follows:

- The log types that are displayed in the **System Log Events** tree node (Under **Network Events**) are those being stored in the database, and are controlled through configuring the system log server, described in 9.6.1.

- The filtering of logs produced by the device that are sent to the NMS is controlled by applying log filters. This is described in [9.6.2](#).
- Controlling what actions to take upon the reception of system logs is controlled through the Event Filter, described in [9.5](#). Details on filtering for system logs are given in [9.5.5](#).

Note: On Solaris, upon server startup if there is a default unix syslogd running; then it will be shutdown so the port 514 is used by the NMS to run its own Syslog Process.

9.6.1 Configuring the System Log Server

The AlliedView NMS System Log Server is automatically configured to Enabled during installation. You can view the current configuration and modify it to better meet your requirements, if necessary. To view the current configuration, select **Tools -> System Log Configuration** for the Panel-Specific Menu. The System Log Server Configuration form, shown in the following figure, will appear.

Event Type	Enable Logging?
ADSL (ADSL Configuration and Statistics)	<input type="checkbox"/>
AUTH (Security/Authorization Messages)	<input type="checkbox"/>
BATCH (Trigger Facility/Scripting Activity)	<input type="checkbox"/>
CARD (Card Configuration)	<input type="checkbox"/>
CFCP (CFC Protection)	<input type="checkbox"/>
CHAS (Chassis)	<input type="checkbox"/>
CIRC (State Change/Error on Circuit)	<input type="checkbox"/>
CLI (Command-line Interface)	<input checked="" type="checkbox"/>
CMD (Command Processing)	<input type="checkbox"/>
CONFIG (Device Config. Messages)	<input type="checkbox"/>
CUC (Cooling Unit Controller)	<input type="checkbox"/>
DHCP (Dynamic Host Configuration Protocol)	<input type="checkbox"/>
FAN (Fan Unit)	<input type="checkbox"/>
FILE (File Changes)	<input type="checkbox"/>
IGMP (IGMP Configurations)	<input type="checkbox"/>
IPFILT (IP Filtering Matches)	<input type="checkbox"/>
LOG (Log Management)	<input type="checkbox"/>
MSG (Device Messages)	<input checked="" type="checkbox"/>
OTHER (All Other Types)	<input type="checkbox"/>
PINT (Physical Interface)	<input checked="" type="checkbox"/>
PORT (Port Changes)	<input checked="" type="checkbox"/>
RMON (Remote Monitoring Protocol)	<input type="checkbox"/>
RSVP (Resource Reservation Protocol)	<input type="checkbox"/>
SHLF (Shelf Changes)	<input type="checkbox"/>
SNTP (Time Setting Changes)	<input type="checkbox"/>
SSH (Secure Shell)	<input type="checkbox"/>
STP (Spanning Tree Protocol)	<input type="checkbox"/>
SYS (Overall System Changes)	<input type="checkbox"/>
SYSINFO (System Status and alarms)	<input type="checkbox"/>
TRAP (Trap Notifications)	<input type="checkbox"/>
USER (Random User-level Messages)	<input type="checkbox"/>
VINT (State Change/Error on Virtual Interface)	<input type="checkbox"/>

FIGURE 9-15 System Log Server Configuration Form - Initial State

Select the checkboxes as follows:

- **Enable System Log Daemon** - Enables or disables the Log Daemon, so that events can be logged.

- **Log to Database** - Enables or disables storing of logs in the NMS database.
- **Log to Local File** - Enables or disables storing of the logs to a local file, <NMS-Home>/logs/syslog.txt
- **Include Non-Discovered Devices** - Enables or disables the including of system events from non-discovered devices

Note: Various combinations of checkboxes are possible, so for example the administrator may wish to include syslogs from non-discovered devices and send these only to the local file.

- **Logging by Event Type** - a list of the types of logs that may be received from the devices. A checkbox is provided for each to allow you to enable or disable the log as needed. When checked, logs of that type are stored in the database or local file (or both) as they are received. What is selected here, as well as any log filters that are applied, control what is shown in the System Log Events table.

At the bottom of the form, the **Apply** button applies any changes you make to the form, while the **Cancel** button cancels the operation without making any changes and closes the form.

Note: Logging a large number of event types may affect the performance of the AlliedView NMS Server. To ensure optimum performance, select only the event types that you need to monitor and disable any event types that are not needed.

Note: The administrator should be aware that non-discovered devices are not managed/controlled by the NMS, and are therefore not part of NMS applications.

9.6.2 Applying Log Filters

You can further refine your system logging by applying log filters to your network devices on a per-device basis. Filters will screen the incoming logs and store only those of a certain type from a specific device. You can apply log filters to specific devices as follows:

1. In the NMS Tree, click the Physical Network submap under Network Maps.
2. In the Physical Network submap, select the devices on which you want to apply the log filters. (Shift+right-click to select multiple devices.)
3. In the Panel-Specific Menu Bar, select **Tools -> Application Manager**.
4. From the **Application Manager** drop-down menu, select **SysLog Management**.
5. Click the **Collect Data** icon () to get the latest information.
6. Select the device or devices on which you want to apply the log filters (Shift+right-click to select multiple devices), right-click, and then select **Modify Log** from the pop-up menu.

*Note: You can also select the device and click **Modify**.*

The Modify Log Properties form, shown in the following figure, will appear.

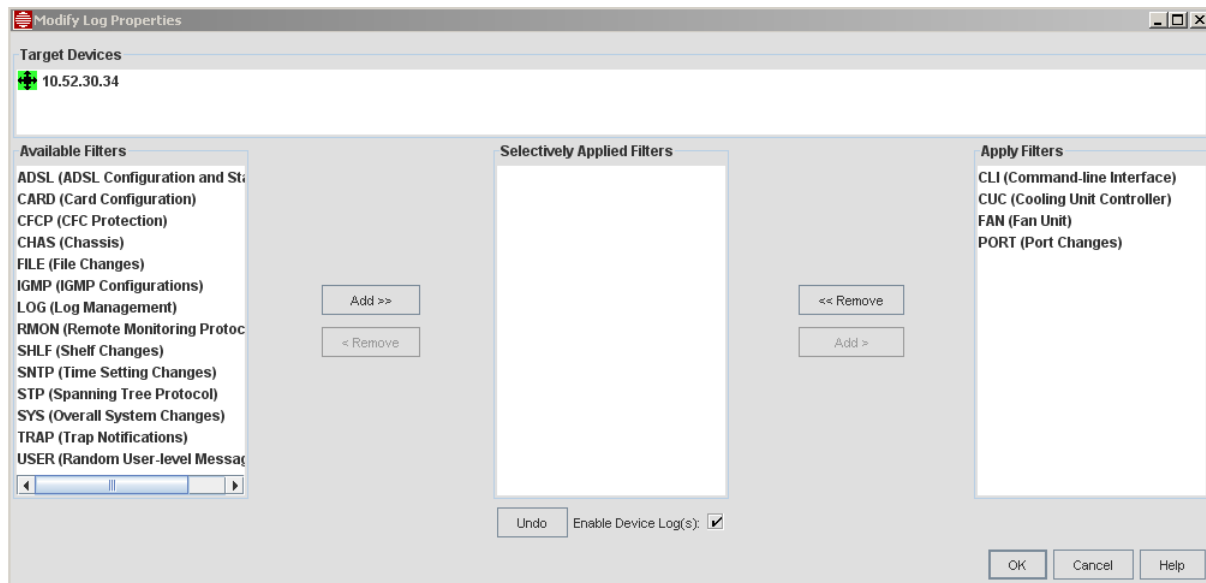

FIGURE 9-16 Modify Log Properties Form - File

To add a filter, select the desired filter in the **Available Filters** list, and then click **Add>>**. To remove a filter, select the filter you want to remove in the **Apply Filters** list, and then click **<<Remove**.

Note: Log filters are device-specific, which means a given filter may not apply to all device types. If a filter does not apply to all of the selected devices, the filter will appear in the **Selectively Applied Filters** list. If a filter is applied to a device that does not support the filter, the device will simply ignore the filter. When applying log filters to multiple devices, it is recommended that you select only devices of the same family.

- Once you have the filters you want to apply in the **Apply Filters** list, make sure the **Enable Device Log(s)** checkbox is checked, and then click **OK**.

9.6.3 Configuring Log Actions

Event filters can be used to trigger actions on specific logs. The filter must specify the category of the desired log message and any other criteria applicable to the log, and an action. Refer to 9.5 for information on setting up event filters.

9.6.4 Viewing Logs

System logs are stored in the NMS database, file (or both) as they are received. The actual logs stored depend on the log types that are enabled and the log filters applied to each managed device. You can view all of the logs received on your network from the System Log Events subview of the Network Events view. Refer to the *NMS User Guide* for more information on the System Log Events subview.

You can view logs on a specific device as follows:

- In the NMS Tree, select the Physical Network submap under Network Maps.
- Right-click the device on which you want to view logs, and then select **View Device Log**. The Log Management Viewer window, shown in the following figure, will appear.

Device SeqID	Device Date	Category	Component	Message
4923	21-Jun-2009 10:36:...	CLI001	INFO	User: "officer" at IP: "10.52.201.222" entered CLI command: DISABLE MORE
4924	21-Jun-2009 10:36:...	CLI001	INFO	User: "officer" at IP: "10.52.201.222" entered CLI command: SHOW LOG OUTPUT
4925	21-Jun-2009 10:36:...	CLI001	INFO	User: "officer" at IP: "10.52.201.222" entered CLI command: SHOW LOG FILTER
4926	21-Jun-2009 10:36:...	CLI001	INFO	User: "officer" at IP: "10.52.201.222" entered CLI command: SHOW SESSIONS
4927	21-Jun-2009 10:36:...	CLI001	INFO	User: "officer" at IP: "10.52.201.222" entered CLI command: SHOW LOG FILTER
4928	21-Jun-2009 10:36:...	CLI001	INFO	User: "officer" at IP: "10.52.201.222" entered CLI command: SHOW DHCPRELAY
4929	21-Jun-2009 10:36:...	CLI001	INFO	User: "officer" at IP: "10.52.201.222" entered CLI command: SHOW EPR=all
4930	21-Jun-2009 10:36:...	CLI001	INFO	User: "officer" at IP: "10.52.201.222" entered CLI command: SHOW CLASSIFIER=all INTERFACE=ALL FULL
4931	21-Jun-2009 10:36:...	CLI001	INFO	User: "officer" at IP: "10.52.201.222" entered CLI command: SHOW DHCPRELAY=ALL FULL
4932	21-Jun-2009 10:36:...	CLI001	INFO	User: "officer" at IP: "10.52.201.222" entered CLI command: SHOW EGRESSLIMITER INTERFACE=all
4933	21-Jun-2009 10:36:...	CLI001	INFO	User: "officer" at IP: "10.52.201.222" entered CLI command: SHOW STP INSTANCE=MAIN
4934	21-Jun-2009 10:36:...	CLI001	INFO	User: "officer" at IP: "10.52.201.222" entered CLI command: SHOW STP INTERFACE=[0,0,2-23],[2,0-23],[4,0-1],[5,0-...
4935	21-Jun-2009 10:42:...	USER003	INFO	User: officer at IP: 10.52.201.222 has logged out
4936	21-Jun-2009 10:45:...	CARD043	INFO	Location: Slot: 2 Description: Restart requested by OAM Audit Task
4937	21-Jun-2009 10:45:...	CARD016	INFO	Location: Slot: 2 Description: Card state change From: UP-DOWN-Failed To: UP-DOWN-Reset
4938	21-Jun-2009 10:45:...	CARD006	INFO	Location: Slot: 2 Description: Card Failure Cleared Reason Code: Incompatible Load
4939	21-Jun-2009 10:45:...	CARD016	INFO	Location: Slot: 2 Description: Card state change From: UP-DOWN-Reset To: UP-DOWN-Offline
4940	21-Jun-2009 10:45:...	CARD005	INFO	Location: Slot: 2 Description: Card Failure Raised Reason Code: Incompatible Load

FIGURE 9-17 Log Management Viewer

- To sort the logs, click the header on which you want to sort (e.g. **Device SeqID**, **Device Date**, etc.) until the desired sort is performed (up arrow for descending or down arrow for ascending).
- Click **Close** to close the window.

9.6.5 Disabling and Re-enabling Logs from a Device

You can disable logs from a device as follows:

- From the Physical Network view, select the device or devices on which you want to disable logs.
- Select **Tools -> Application Manager** from the Panel-Specific Menu.
- Select **SysLog Manager** from the Application Manager pull-down menu.

Note: For a single device, you can also access the **SysLog Manager** panel by right-clicking the device in the Physical Network view, and then select **Provision -> Syslog Management** from the pop-up menu.

- In the **SysLog Manager** panel, select the device or devices in the list (use Shift+right-click to select multiple devices), and then click **Modify**. The Modify Log Properties form will appear as shown in Figure 9-16.
- In the Modify Log Properties form, uncheck the **Enable Device Log(s)** checkbox, and then click **OK**. This will close the form. On the **SysLog Manager** panel, the **Status** for each selected device will change to **Disabled**. The logs for these devices are now disabled.

To re-enable disabled logs, repeat this procedure except check the **Enabled Device Logs(s)** checkbox in the last step. The **Status** for each selected device in the **SysLog Manager** panel will change to **Enabled**, which indicates that the logs are enabled for the device(s).

9.6.6 OTHER Event Type

An additional Event Type, OTHER, is for all other log events that are not part of the other event types. This event type can include events from debug, kernel, and third party devices.

Note: Because of the special nature of this event type, the user may find it useful to create a custom view to isolate this event type (in the Custom View form the user would fill in the Category field as **SYSLOG-OTHER** and then **Apply Filter**). This view could then be exported to a file for further analysis.

9.7 Alarm View Display

Select the node **Alarms** from the NMS Tree to view the Alarms, as shown in the following figure.

Status	Failure Object	Alarm Message	Date/Time	Alarm Group
Clear	IF-10.52.194.177	Interface clear.	Sep 22,2010 04:48:53 PM	10.52.194.139
Clear	IF-10.52.195.193	Interface clear.	Sep 22,2010 04:48:01 PM	10.52.194.178
Clear	IF-10.52.195.161	Interface clear.	Sep 22,2010 04:47:51 PM	10.52.194.178
Clear	IF-10.52.195.65	Interface clear.	Sep 22,2010 04:47:46 PM	10.52.194.178
Clear	IF-10.52.195.129	Interface clear.	Sep 22,2010 04:47:41 PM	10.52.194.178
Clear	IF-10.52.195.81	Interface clear.	Sep 22,2010 04:47:38 PM	10.52.194.178
Clear	IF-10.52.195.97	Interface clear.	Sep 22,2010 04:47:33 PM	10.52.194.178
Clear	IF-10.52.195.225	Interface clear.	Sep 22,2010 04:47:28 PM	10.52.194.178
Warning	10.52.194.164;xemRemoved-2	XEM removed - sysUpTime: 0 hours, 50 minutes, 54 seconds., sn...	Sep 22,2010 03:59:29 PM	10.52.194.164
Clear	10.52.30.37	Node clear. No failures on this node.	Sep 22,2010 03:50:08 PM	10.52.30.37
Clear	ADSL_10.52.30.37_Port10.1	Link Up on Port=10.1 -- SNMP Trap Vars: sysUpTime=40 days, 6 ...	Sep 22,2010 03:50:07 PM	10.52.30.37
Clear	VLANIF-10.52.30.35-7_Port5.11	VLANIF Port Problem Cleared at Port=5.11 on 10.52.30.35	Sep 22,2010 03:29:54 PM	10.52.30.35
Clear	VLANIF-10.52.30.35-10_Port5...	VLANIF Port Problem Cleared at Port=5.11 on 10.52.30.35	Sep 22,2010 03:29:54 PM	10.52.30.35
Clear	VLANIF-10.52.30.35-20_Port5...	VLANIF Port Problem Cleared at Port=5.11 on 10.52.30.35	Sep 22,2010 03:29:54 PM	10.52.30.35
Clear	VLANIF-10.52.30.35-40_Port5...	VLANIF Port Problem Cleared at Port=5.11 on 10.52.30.35	Sep 22,2010 03:29:54 PM	10.52.30.35
Clear	Ether-like_10.52.30.35_Port5.11	Link Up on Port=5.11 -- SNMP Trap Vars: sysUpTime=30 days, 3 ...	Sep 22,2010 03:29:54 PM	10.52.30.35
Major	IF-10.52.110.177	Interface failure. Status poll failed.	Sep 22,2010 03:19:12 PM	10.52.194.164
Major	IF-10.52.110.193	Interface failure. Status poll failed.	Sep 22,2010 03:18:43 PM	10.52.194.164
Major	IF-10.52.110.225	Interface failure. Status poll failed.	Sep 22,2010 03:18:02 PM	10.52.194.164
Major	IF-10.52.110.241	Interface failure. Status poll failed.	Sep 22,2010 03:17:41 PM	10.52.194.164
Warning	10.52.194.164;xemRemoved-1	XEM removed - sysUpTime: 0 hours, 5 minutes, 51 seconds., snm...	Sep 22,2010 03:14:29 PM	10.52.194.164

FIGURE 9-18 Alarm View Main Panel

Refer to the *NMS User Guide* for general information on navigating in the view and using the search tool.

9.8 Alarm Propagation

9.8.1 Overview

In a network, components (managed objects) are in a hierarchy, and faults at one level usually affect the status of another level. Network administrators need to understand how the AlliedView NMS reports and propagates alarms so that they can control what alarms appear in the Alarm View and quickly locate and resolve them.

Refer to [Figure 9-19](#) while reading this section, since it helps show the types of methods used to obtain the status of an object and the objects relationship to the network hierarchy.

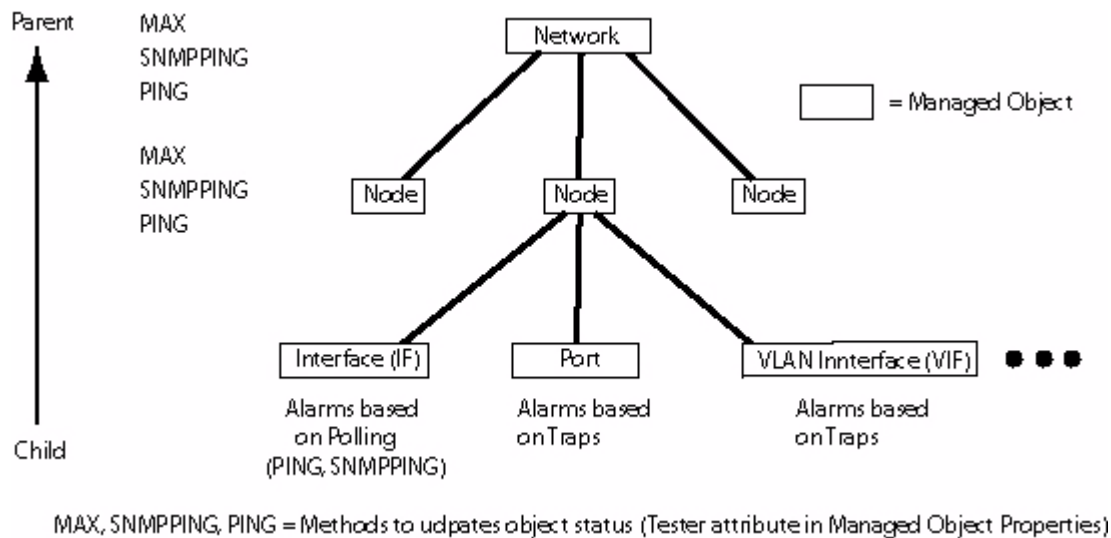

FIGURE 9-19 Alarm Propagation Hierarchy

There are various methods used to get the status of a managed object:

- **PING** - This uses ICMP for polling, and so uses a simple traceroute to see if the object responds. If there is no response, an alarm (usually MAJOR) is produced.
- **SNMPPING** - This uses an SNMP GET for polling, and waits for a response. If there is no response, an alarm (usually MAJOR) is produced. Moreover, if there is no response within 5 seconds, there is an additional time out alarm.
- **Traps** - These are the unsolicited messages that are sent by the device, with a resulting alarm.
- **MAX** - This is not an actual method (there is no direct communication with the object), but a rolling up of the status results of an object and its children objects and a reporting of the alarm of the highest severity. The examples below will explain this in greater detail and show how this works.

The main concepts for alarm propagation up the hierarchy are as follows:

- The status of an object is the highest severity alarm for that object.
- When alarms are propagated, the highest alarm of all children is what gets propagated (if parent set to MAX).
- The severity of an alarm on the parent object (node) is the highest severity for that node, including the severities that are propagated (if parent set to MAX).

9.8.2 Controlling Alarm Propagation

While referring to [Figure 9-19](#), consider the following examples:

9.8.2.1 Example 1 - Parent Object set to Max for Polling-Based Alarms (default)

- The administrator sets the Tester attribute for interfaces (IF) in the MO Property Form to PING or SNMPPING, so if an interface fails, a major alarm is reported by the interface.
- For the parent node, the administrator sets the Tester attribute to Max.

The result of this set up is as follows:

- If an interface fails, the alarm is reported at the node level, with the text of the alarm “one or more interfaces have failed.”
- Since an alarm at the interface level will result in an alarm at the node level, the node level alarm is not cleared until all interface alarms have been set to CLEAR by the AlliedView NMS.
- If the parent node has a failure of higher severity, the parent node will take precedence.

Note that this concept of propagating alarms up the hierarchy works at both the Node and Network level; the node reports among the interfaces the highest level of alarm, while at the network level, MAX means the network reports among the nodes the highest level of alarm. Alarms at the node level would be propagated to the network object with the text “One or more Nodes have a Major Alarm.”

9.8.2.2 Example 2 - Parent Object set to PING/SNMPPING (not Max) for Polling-Based Alarms

In this scenario, the higher level object is not set to Max, but to PING/SNMPPING. The following occurs:

- The higher level object will only poll the primary IP interface of its child object.
- There is less “sensitivity” of the higher level object to lower level alarms, since other alarms at the lower level are not reported to the higher object.

9.8.2.3 Example 3 - Parent Object set to Max for Trap-Based Alarms

Note: The function of the MAX value for objects that use traps to produce alarms is the same of those produced by traps. This is made a separate example to highlight certain differences.

- For a port, the administrator does **not** use the Tester attribute, since alarms are reported by the unsolicited trap.
- For the parent node, the administrator sets the Tester attribute to Max.

The result of this set up is as follows:

- If a port has a trap, the alarm is reported at the node level.
- When a port has recovered and a Link UP trap is received by the AlliedView NMS, this is still a trap and therefore the CLEAR status “alarm” would be reported to the parent level.
- When a port has recovered on the device and a Link UP trap is not received by the AlliedView NMS, the node would still show an alarm.
- If the parent node has a failure, the parent node will take precedence.

9.9 Configuring Alarm Filters

9.9.1 Overview

Alert filters are used to filter and modify the properties of an incoming alert. When the alert matches specified criteria, an action (such as sending an email) will occur.

To parse alarms, select *Edit -> Configure -> Alarm Filters* from the main menu of the Alarms Panel. The **Alert Filter Configuration** form appears as shown in [Figure 9-20](#).

FIGURE 9-20 Alert Filter Configuration Form

This form allows the Administrator to configure both the alert filter (the left side of the screen) and the filter action (the right side of the screen).

Note: Many of the actions and fields are similar to setting Event Filters, so there are references when appropriate.

The user can add, modify, or delete an Alert Filter from the left side of the form. Refer to [Table 9-5](#) for a summary of match criteria.



At least one action needs to be associated with the incoming filtered alarm. For an alarm filter, click  under filter action to add one of the action types. These types are explained in [9.5.3](#).

9.9.2 Example to Configure Alarm Filter and Actions

9.9.2.1 Summary Procedure

Adding an alarm filter and an action is done as follows.

Note: An alarm filter must have at least one action.

1. Click  in the Alert Filter panel.
2. Modify the alert filter name as needed and the match (Source and Severity) criteria fields. If needed, expressions can be used: wildcard (*), negation (!), and separators (.). Use the More option if needed.
3. Click  in the Alert Filter Action panel to activate the Action Type panel.
4. Click one of the buttons for each action type and select **New** or **Edit**.
5. Fill in the Action Details panel, and then click **Update Action**. The **Update Action** button changes to **Update Filter**.
6. To add more actions, click **Add** in the Alert Action panel and add more action types and details.
7. Cancel any filters or actions by clicking **Cancel** as they appear in context.
8. If desired, reorder the resulting alert filters and actions by dragging and dropping.

To modify an alert filter, select a filter from the list and make any changes, and then click **Apply** to make the changes permanent.

To delete an alert filter, select a filter and click the **Delete icon** from the Alert Filter panel. Any associated action will also be deleted. To delete a filter action, select an action from the Configured Filter List, and then click the **Delete icon** from the Alert Filter action panel.

To load a set of alert filters from a file, click **Load/Save**. A dialog box prompts for the file path to read the filters from. Click **Load** to load the filters.

To save a set of alert filters (for later use or as a backup), click **Save**. A dialog box prompts for the file path to write the filters to. Click **Save** to save the filters.

Note: When saving these files, the AlliedView NMS sets as the default directory the `<NMS Home>/state` directory, so for example the file path:

```
../conf/alert.filters
```

is being saved in the `conf` directory by going up one level from the `state` directory (`..`) and then down to the `conf` directory. If the user enters in the form only a file name, that file is being saved in the default `state` directory.

If any changes are made and the window is closed without clicking **Apply**, a prompt will appear asking whether to make the changes.

9.9.2.2 Detailed Procedure

A step-by-step procedure shows how to take alarms from iMGs with an IP address fo 10.10.50.*, and eliminate alarms that comes in with the text “Unable to login to this device..” .

1. Select **Edit --> Configure -> Alarm Filters** to access the Alert Filters window, as shown in [Figure 9-21](#).

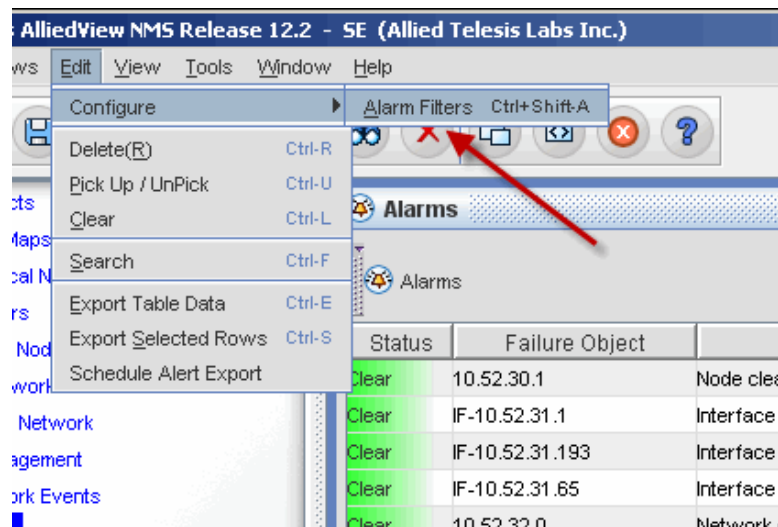



FIGURE 9-21 Accessing the Alert Filters Window

2. Create the filter and set up the basic criteria for filtering. The steps would be:

1. Select the  button on the bottom left
2. Rename the filter to something that will indicate its use.
3. Add a match criteria. Here the source is the incoming address and it can be wild-carded by using the “*”.
4. Refer to the following figure, which displays these three steps.

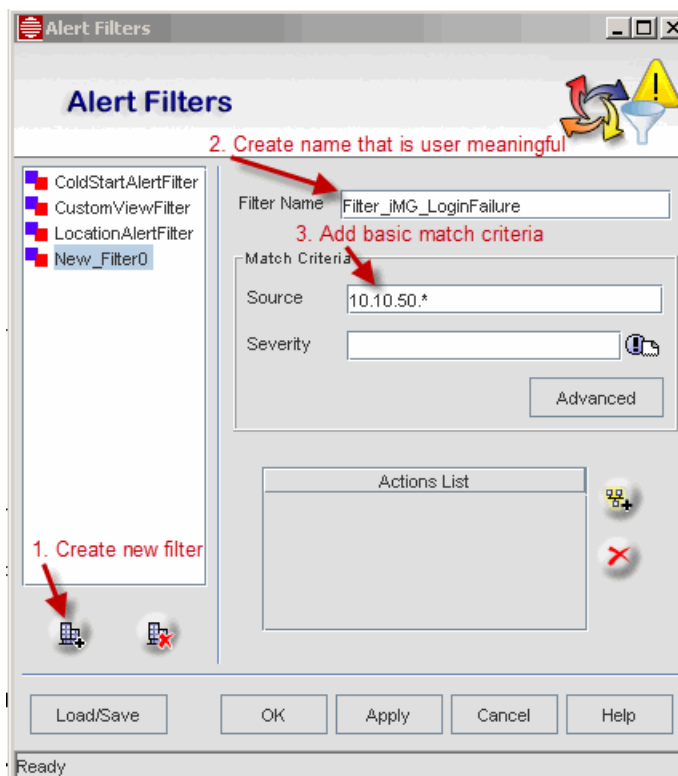

FIGURE 9-22 Create Alert Filter with Basic Match Criteria

- 3. To create a criteria beyond the Source and Severity, select **Advanced**. The *Match Criteria Properties* screen appears.
- 4. In this example we will setup a filter to eliminate an alarm that comes in with the message “Unable to login to this device...”. Enter this using a wildcard in the Message field as shown in [Figure 9-23](#), then select **OK**.

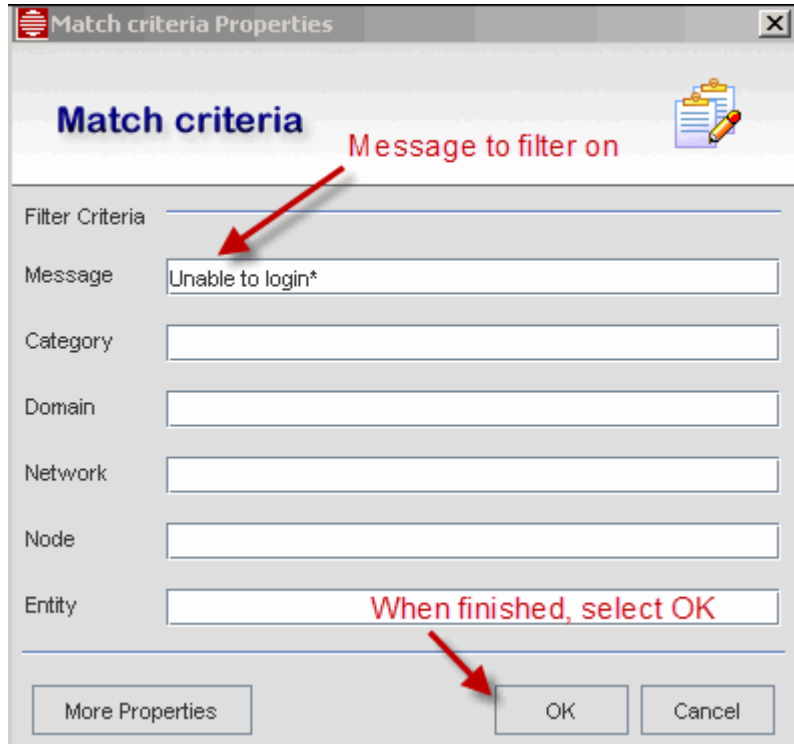



FIGURE 9-23 Setting Advanced Filter Criteria

- 5. Back on the *Alert Filters* screen, we need to associate it with some action to take. We create the filter action by clicking on the add  button (next to the Actions List). This brings up the *Add action* screen, as shown in [Figure 9-24](#).

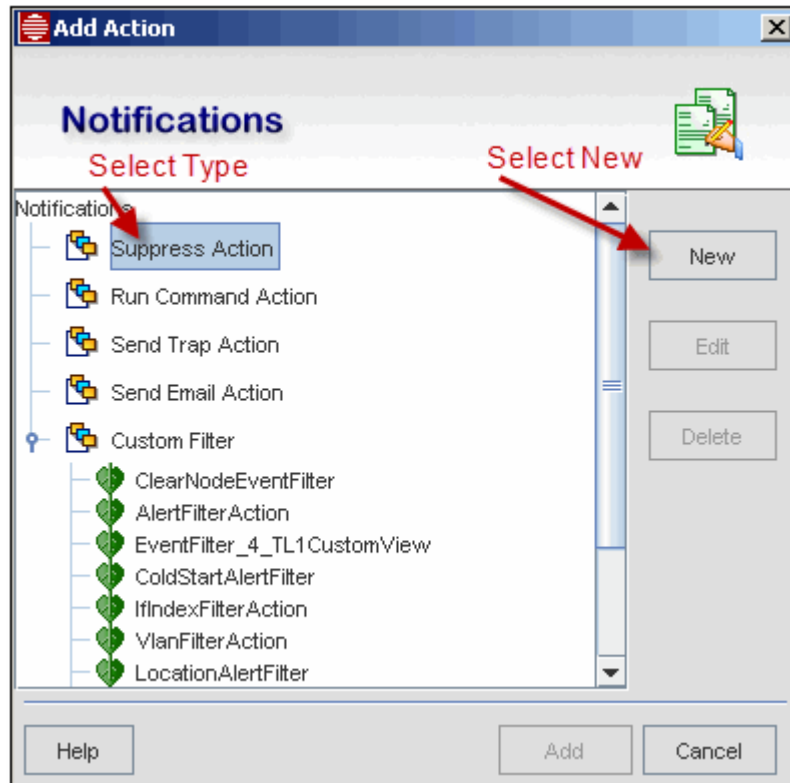

FIGURE 9-24 Add Action Window (Notifications when Criteria Met)

- Since we want to suppress the “Unable to Login..” alarm so that we no longer see it in the alarm list, select the **Suppress Action** type and **New** button, as shown in Figure 9-24. The Suppress Action window appears, as shown in the Figure 9-25.

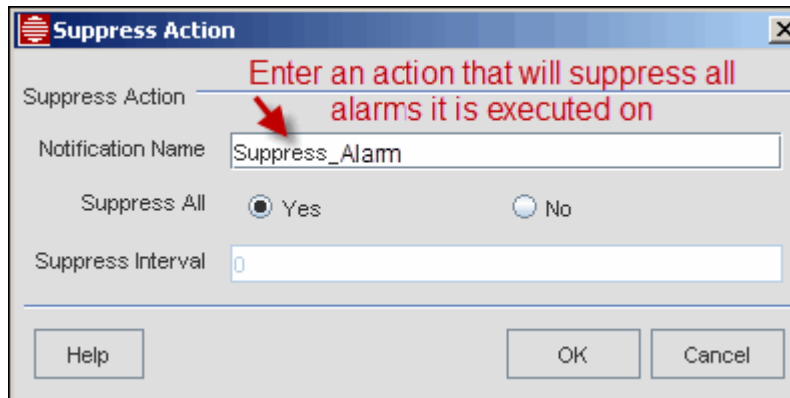

FIGURE 9-25 Enter Notification Name

- Add the Notification Name (in this case Suppress_Alarm), and Click **OK**, as also shown in Figure 9-25.

- 8. Back on the *Add Action* screen, select the Notification Type you created (here **Suppress_Alarm**) and Select **Add**, as shown in [Figure 9-26](#).

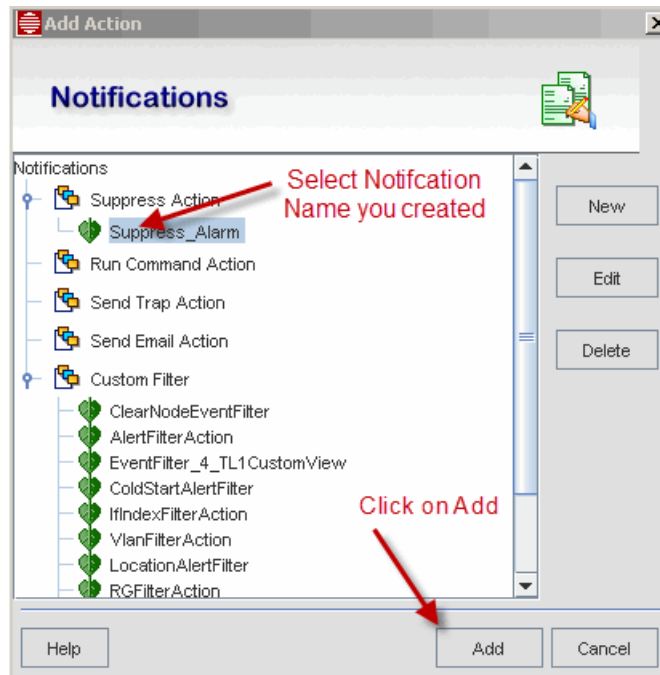

FIGURE 9-26 Adding an Action to the Alert Filter

- 9. This returns you to the *Alert Filters* window, and **Suppress_Alarm** is added to the Actions List. Refer to [Figure 9-27](#).

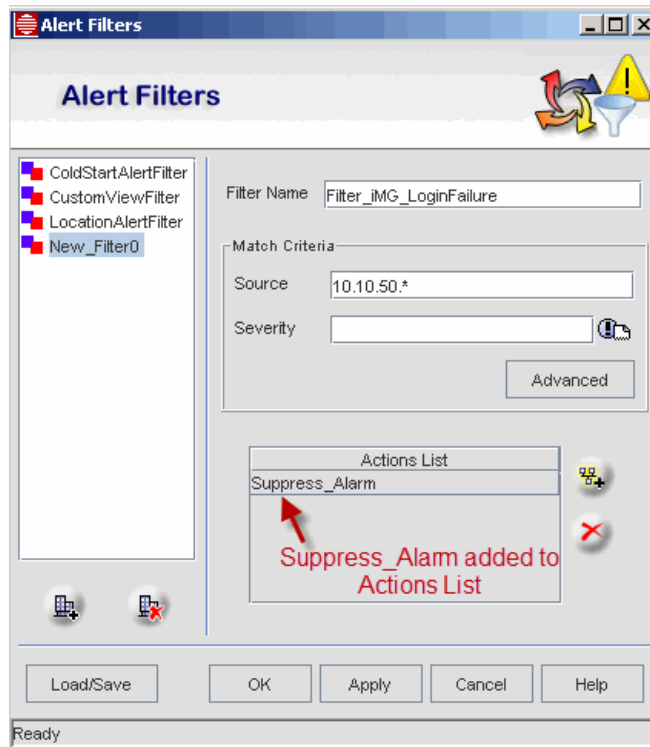

FIGURE 9-27 Actions List Complete

- With the attributes for the Alert Filter complete, click on **Apply**. The new filter name (Filter_iMG_LoginFailure) is now added to the list of Alert Filters, and this filter will be applied when processing alarms. Refer to the following figure.

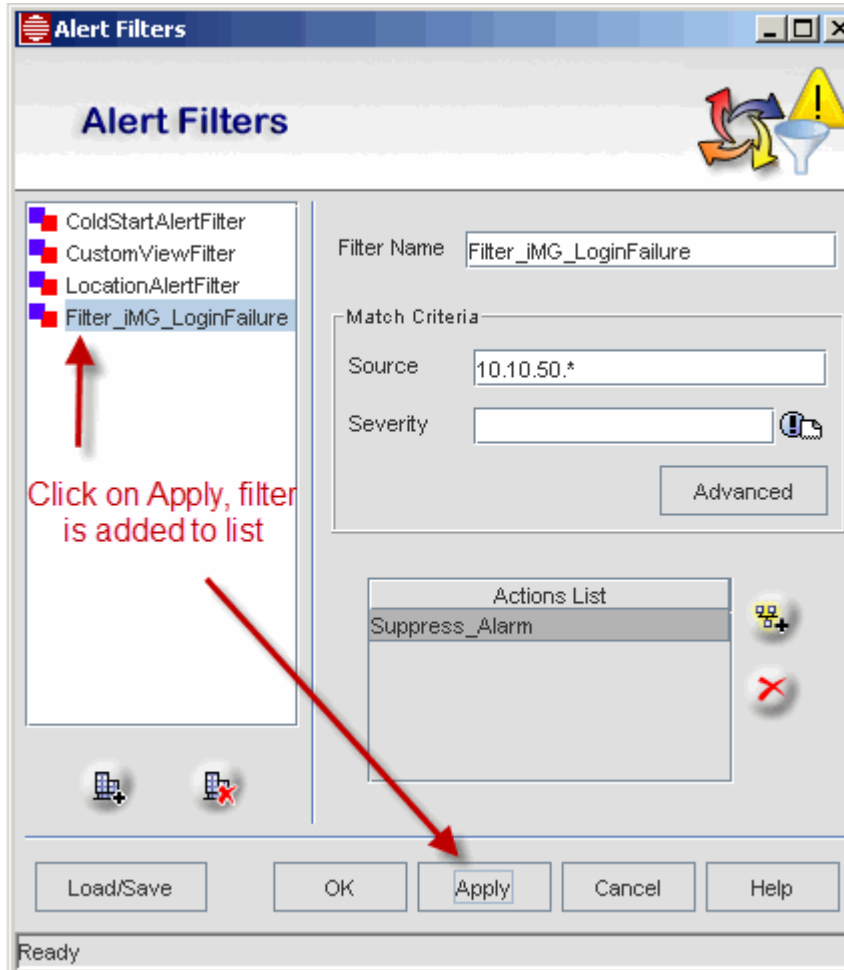

FIGURE 9-28 Alert Filter added to List

- With the Alert Filter added, Click on Load/Save. This brings up the Filter Details window that allows you to save the filters to the `alert.filters` file. Click on **Save**. The file can then be loaded for later use.
- With the procedure complete, click on **OK**. The *Alert Filters* window closes.

9.10 Retrieval of Alarms during (Re)Discovery (Telesis MAP Devices Only)

9.10.1 Overview

Prior to release 6.0, the (re)discovery process included establishing communication and transferring configuration information, but did not include alarm processing.

In release 6.0, a feature, Alarm Retrieval During (Re)Discovery, allows the administrator to have alarm retrieval included during (re)discovery. When activated, at the end of (re)discovery, the following occurs:

- Alarms are retrieved using CLI (currently)
- The alarms are parsed and converted to events
- These events are processed by Alarm Management and therefore can be parsed, filtered, customized, and have other actions associated with them.
- After processing, they are added to the AlliedView NMS database so that they can be included in the Events and Alarms displays.

If an alarm existed on the device prior to the (re)discovery and the retrieval of the alarms shows the alarm no longer exists, the AlliedView NMS will show the alarm as cleared.

All alarms displayed by this feature include the text “Retrieved:true” in the message of the event/alert to show that these were the result of the actions or this feature.

9.10.2 Enable / Disable the Feature (Feature is Optional)

To enable or disable this feature, a script is run that brings up the **Retrieve Alarms** form.

Note: Administrator (or root) permissions on the NMS machine are required for any changes to succeed.

The script is in the <NMS_HOME>/bin directory and can run using the command line or a double click:

- For double-click, open the file window <NMS_HOME>/bin directory and double-click on:
 - AT_RetrieveAlarmsSetup.bat (Windows)
 - AT_RetrieveAlarmsSetup.sh (Solaris)
- For command line, go to the <NMS_HOME>/bin directory and execute:
 - AT_RetrieveAlarmsSetup.bat (Windows)
 - AT_RetrieveAlarmsSetup.sh (Solaris)

The following dialog is displayed.

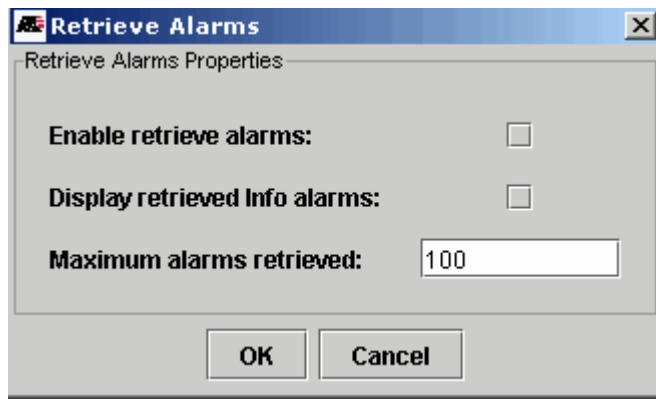

FIGURE 9-29 Retrieve Alarms Form

The following options are available on the retrieve alarms dialog:

- **Enable retrieve alarms:** When selected it will enable this feature and current alarms on MAP devices will be displayed during discovery.
- **Display retrieved Info alarms:** When selected it will enable displaying retrieved alarms that have 'Info' severity. The current NMS shows these as Info events only and no Alert is created.
- **Maximum alarms retrieved:** Number of retrieved alarms (per device) that should be processed and displayed. If this number is lower than current count of retrieved alarms the lowest severity alarms will be ignored.

After making changes click on **OK** to apply changes or **Cancel** to cancel modifications.

9.10.3 Restrictions / Limitations

Since the Alarm Management system uses traps as another source for device alerts, there are the following interactions between retrieval of alarms through this feature and retrieval of device changes through traps:

- A few of the retrieved alarms do not have enough information to be correlated to the corresponding alarms that were received through traps.
- A few of the retrieved alarms do not have the corresponding alarms received through traps and also some of the alarms received through traps do not have the corresponding alarms that can be retrieved from the device.
- Default severities used when displaying retrieved alarms are specified in the device while alarms received through traps have default severities defined in NMS.

10. Using the HTML Interface

10.1 Overview

The administrative tasks that can be done from the html interface are:

- Manage/Unmanage
- Start/Stop Discovery
- Delete Object(s)

The html interface and how these tasks are accessed are explained in detail in the AlliedView NMS User Guide.

Note: To quit the html interface, use the Logout option. Closing the browser will require 30 minutes for the client session to time out. Refer to the AlliedView NMS User Guide for details.

11. Built-in Browsers - SNMP MIB and CWMP

11.1 Overview - SNMP MIB

Management Information Bases (MIBs) are a collection of definitions that define the properties of the managed objects. To enable a management application to operate intelligently on the data available on the managed device, the manager needs to know the names and types of managed objects in the device. This is made available by the MIB modules. A MIB describes a set of managed objects.

Each property of a managed object in a MIB has a unique identifier. This identifier consists of the type of the object (such as counter, string, gauge, or address), the access level (such as read or read/write), size restrictions, and range information. It should be understood that a MIB is only an abstraction of data available on the managed device and not a physical database or a physically executable object.

Use the following table to locate the task you wish to perform. If you are using NMS, use the Screen Name as well to locate the relevant section.

TABLE 11-1 Task List for MIB Manager

Task	Screen / Form Name (if Applicable)	Section
Review Screen Areas		(11.2)
Load / Unload MIBs	Object Properties	Overview (11.3.1) Loading Options (11.3.2) Loading as Compiled Files (11.3.3) Loading from Database (11.3.4) Loading with MySQL ¹ (11.3.5) Unloading (11.3.6)
Set MIB Browser Settings	MibBrowser Settings	(11.4)
Perform GET, GET NEXT, GET BULK, SET		(11.5)
View SNMP Table Data		(11.6)
View Traps		(11.7)
Create Trap Parser File		Overview (11.8.1) Create Parser File (11.8.2) Add Trap Definitions (11.8.3) Filter Incoming Traps (11.8.4) Setting Parser Parameters (11.8.5)
Plot SNMP data		(11.9)

1. Registered Trademark © 2003 MySQL AB. All rights reserved.

11.2 MIB Browser Screen and Toolbar

The information contained in the MIBs can be retrieved and viewed by accessing the MIB Browser from the Tools menu. The Mib Browser panel is shown in the following figure.

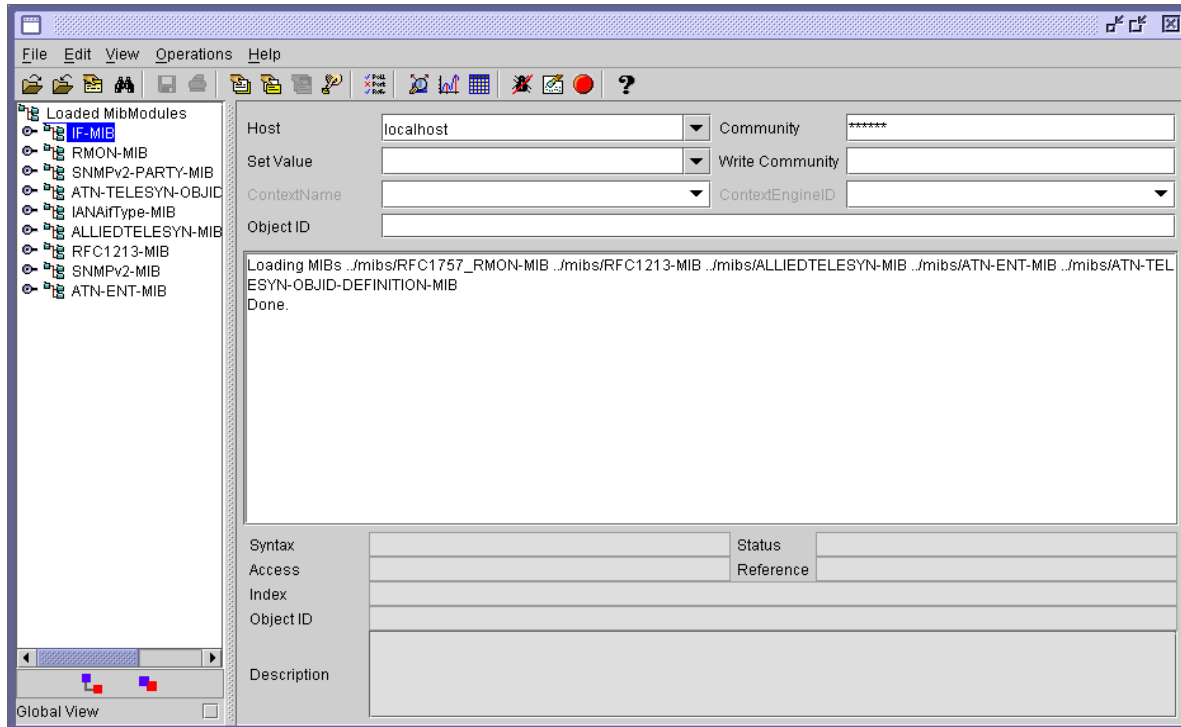

FIGURE 11-1 MIB Manager View

The operations allowed with the Mib Browser are available through the series of icons in the Toolbar at the top of the Mib Browser's main window. You can hide the Toolbar by de-selecting the ToolBar item in the view menu. The Menu Bar is also available for doing all operations.

11.3 Loading and Unloading MIBs

11.3.1 Overview

To load the MIB files in the Mib Browser, use the **LOAD MIBs** button or select *File -> Load MIB* menu item. This brings up the **Load a Mib File** Screen as shown in the following figure.

Note: The MIB Browser for NMS is strict on syntax, and if there is an error, such as an extra comma in the object type list, the MIB will not load.

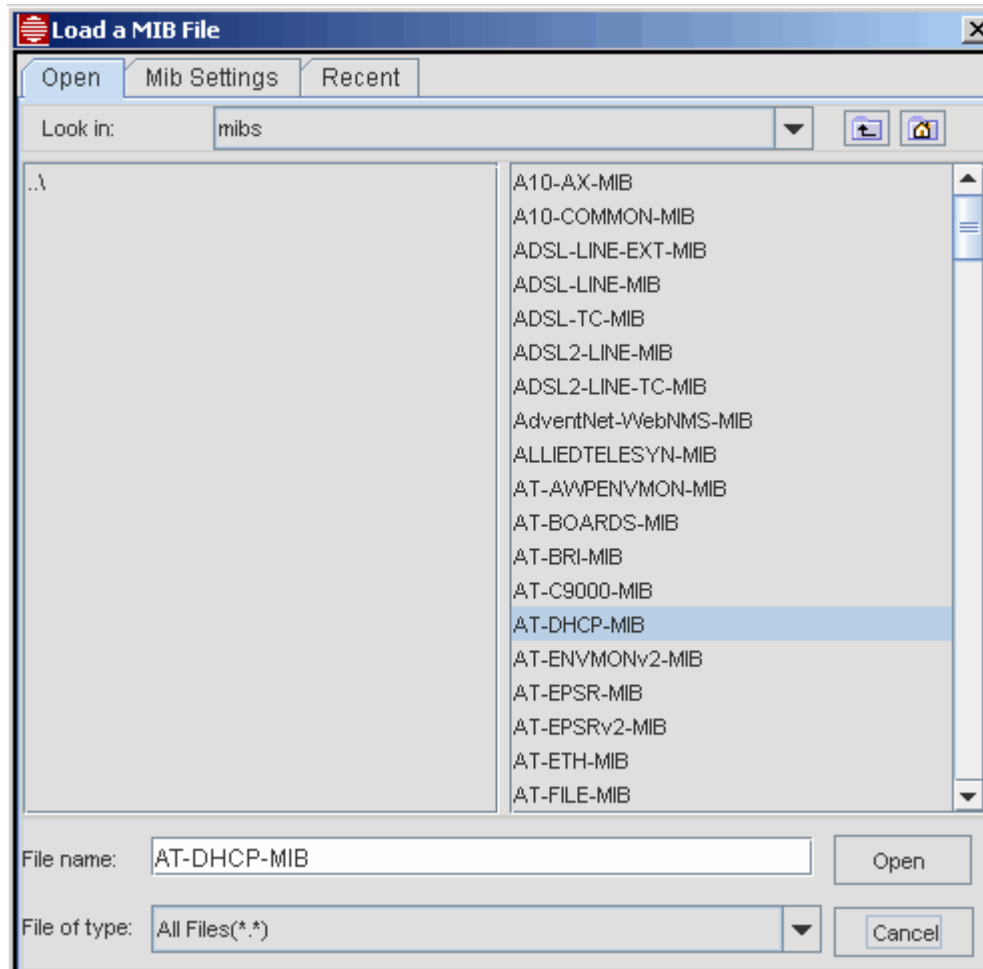

FIGURE 11-2 Load MIB File Screen

11.3.2 Loading Options (Directly, as Compiled Files, Using MySQL)

The Mib Browser has the following Mib Settings for loading the MIBs, as shown in the following figure.

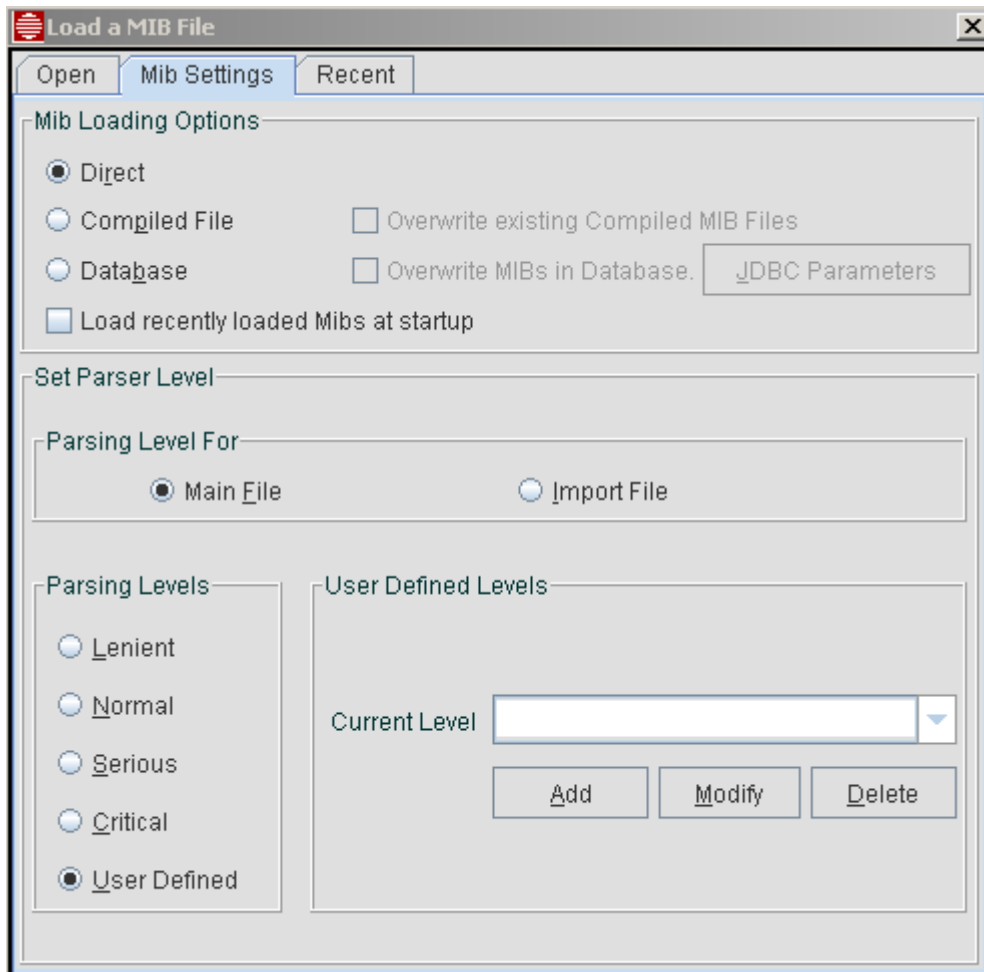

FIGURE 11-3 Options for Loading MIBs

- Loading MIBs directly.
- Loading MIBs as compiled files.
- Loading MIBs from database.

You can also load MIBs directly in plain text format, although for large MIBs the loading time will be higher.

The **Recent** tab lists all the recently loaded MIBs. The MIBs that are listed can be opened by selecting the tic box and then the Open button.

11.3.3 Loading MIBS as Compiled Files

The Mib Browser allows loading of compiled MIB files. The compiled MIB files reduce loading time, leading to performance improvement. To store the compiled file information, there are two file types used for storing the MIB information in a formatted structure:

- **.cmi** - This file type contains MIB information like MibNode, MibModule, naming hierarchy, etc.
- **.cds** - This file type contains the description and reference of the nodes in the Mib.

The compiled MIB files reduce the loading time, leading to performance improvement. The applications and the applets have the option of loading the MIB files directly or as compiled MIB files. The **Load MIBs from compiled File** option is provided in the dialog box to decide whether to load MIB from compiled MIBs or not. By default, this option is enabled. If this is unchecked, the user can directly load the MIB file as provided.

When **Load MIBs from compiled File** is selected, the Mib Browser tries to load the **.cmi** and **.cds** files, if they are present. Otherwise, this parses the MIB file and writes the output in **.cmi** and **.cds** files, and then loads the MIB file. For example, for the RFC1213-MIB the compiled MIB files are *RFC1213-MIB.cmi* and *RFC1213-MIB.cds*. The advantage of using this option is that the MIB need not be parsed each time it is loaded, which reduces the load time.

To load the compiled MIBs, load the **.cmi** file alone. The **.cmi** file will have reference to the **.cds** files. The **mib_file_name.cds** file should not be loaded directly.

11.3.4 Loading MIBs from a Database

The Mib Browser allows loading MIB files from the database. The MIB files can be stored in any RDBMS such as MySQL or Oracle¹. Applications can load these MIB files directly from the database. This feature is particularly useful for a high number of MIB files.

The Mib Browser uses JDBC (Java Database Connectivity) for the database support. Applications should use a valid class 3 JDBC driver of the respective databases to enable the database support.

To add database support for loading the MIBs, applications should initialize the necessary database parameters first. The following details have to be given in the settings dialog:

- DriverName - Name of the DataBase driver.
- URL - URL pointing to the DataBase filename.
- userName - userName.
- passWord - password.

When the **Load MIBs From Database** is enabled in the load options dialog box, the Mib Browser tries to load the MIB file from the database. If the MIB files are already present in the database, the result will be successful. If the MIB files are not present in the database but are available only in the local path in which the application is executed, the MIB files are loaded in the database for the first time, and then loaded in the application.

A few MIB modules are provided in the MIBS directory, i.e. RFC1213-MIB, RFC1271-RMON, RFC1155-SMI, RMON2-MIB, TOKEN-RING-RMON-MIB and RFC1315-FRAME. It may be convenient to copy your MIB module files to be loaded into the mibs directory.

11.3.5 Loading MIBs Using MySQL

The following database parameters have to be configured in the application:

- driver name - org.gjt.mm.mysql.Driver
- url - JDBC: mysql://< machine name > / < database name >
- username - < a valid user name >
- password - < password for the above user >

The jar file **mysql_comp.jar** has to be included in the classpath. If the jar is not in the classpath, the following exception is thrown:

```
Input: Java.lang.ClassNotFoundException:org.gjt.mm.mysql.Driver
```

For other databases, please use the equivalent parameters.

1. Registered Trademark © 2003 Oracle Corporation. All rights reserved.

11.3.6 Unloading MIBs

To unload the loaded MIB, select the node of the MIB Tree then click the **UNLOAD MIB** icon or select the *File -> UnLoad MIB* menu item. This removes the MIB Tree of the unloaded MIB

11.4 MIB Browser Settings

The Mib Browser can be used for MIB browsing and to view and operate on available data through an SNMP agent. The Mib Browser allows configuration of various options needed for SNMP operations.

To set the various options, click the **SETTINGS** icon, or select the *Edit -> Settings* menu item. This brings up a dialog box where the following options and their default values are set. The user can modify the default values as needed, as shown in the following table.

TABLE 11-2 MIB Browser Settings

Options	Default Values	Other Values
Snmp Version	V1	V2c or V3
Snmp Port	161	Any user- defined port
Time out	5 sec	Any user-defined value
Max repetitions	50	Any user-defined value
Graph Type	Line Graph	Bar Chart
Trap Port	162	Any user-defined port
Retries	0	Any user-defined value
Non-repeaters	0	Any user-defined value

FIGURE 11-4 MIB Browser Settings

11.5 SNMP Operations

The Mib Browser allows the user to do the typical SNMP operations, such as GET, GET NEXT, GET BULK and SET.

To perform the GET operation, the user has to load the MIB file, select the desired node, and click the **GET** icon or choose the *Operations -> Get* option from the menu bar. To fully specify an object to an SNMP agent, both the Object ID (which defines the type of object), and the instance (the specific object of the given type) need to be provided. From the MIB, the Object ID can be obtained to which an instance needs to be added to completely identify the object of interest. For non-tabular (or scalar) objects, this is simply an instance of 0 (for example, sysDescr.0). This need not be specified; the Mib Browser adds it to the selected node. For tabular objects, the instance is defined by the MIB and is a sequence of one or more variables (for example, ifInOctets.2 or tcpConnState.179.74.15.126.1192.225.226.126.197.80).

You also need to specify the hostname and community string of the SNMP agent you are talking to in the appropriate field.

To talk to a V3 agent, choose the Version3 from the choice box in the **Settings** dialog and also make sure that the v3 parameters are set in V3 Settings Dialog.



11.5.1 Multi-Varbind Request

Select the *Display -> Multi-Varbind* menu item from the **View** menu to view the Multi-Varbind panel. To do a multiple varbind request, select the leaf node and append the instance, and then click **Add**. This adds the OID given in the Object Identifier field and the Value given in the SetValue field both separated with a colon to the list. If a value is not given in the SetValue field, the NULL value is appended. We can add multiple numbers of OIDs and values like this. Ensure that you check the **Multi-var** checkbox before doing a SNMP operation for multiple varbind SNMP request. Otherwise, it will do a request for the OID in the Object Identifier field.

To do multiple-variable SNMP SET, ensure that the proper OIDs and values are given in the text fields before adding them to the list. Check the **Multi-Var** check box before doing the multiple variable SET.

To delete the varbind(s) from the list select the varbind(s) from the list and click **Delete** to delete the varbind(s) from the list.

To edit the varbinds added in the list, select a varbind and click **Edit**. This shows an OID and the Value of the varbind in the TextFields to edit the OID and the Value. Edit it and press **OK** button to modify the OID and the value or click **Cancel** to restore the old values.

- To perform a GET operation, click the GET icon () or select the **Operations -> Get** menu item. If the MIB node and instance are specified, this gets all objects under the selected MIB object or the specific object.
- To perform a GETNEXT operation, click the GETNEXT icon () or select the **Operations -> GetNext** menu item. If a MIB node is specified, this gets the next object after the specified object or the specific object instance.
- To perform a GETBULK operation, click the GETBULK icon () or select the **Operations -> GetBulk** menu item. This gets a sequence of Next Objects immediately after the specified object. The number of Object instances returned is equal to the Max-Repetitions field v2 & v3.

Note: Max Repetitions cannot exceed 200.

- To perform a SET operation, click the SET icon () or select the **Operations -> Set** menu item. This enables setting the value of the specified object, based on the value in the Set Value field. To do a SET for Octet String Type in hex format, enter the bytes in hex format with each bytes separated by a colon and the entire string within single quotes. For example, to give 0xff0a3212 enter 'ff:0a:32:12' in the SetValue field.

11.6 MIB Browser – Table Operations

The Mib Browser provides a user-friendly way for viewing SNMP Table data. The table data can be viewed in a separate window called SNMP Table Panel. The SNMP Table Panel provides various options for table handling, such as adding a row to the existing table, viewing graphs, index editor, etc.

Perform the following steps to view the SNMP table in the SNMP Table Panel:

1. Make sure the appropriate MIBs have been loaded.
2. Specify the proper agent hostname or IP address in the host field of the MibBrowser.
3. Specify a valid OID - the OID needs to be a Table OID.
4. The OID can be chosen by browsing the MIB in the MIB Tree.

To view the SNMP Table, click the **SNMP TABLE** icon or select the **View -> SNMP Table** menu item. If the selected OID is a table, this displays an SNMP table. In the SNMP table, click **Start** to get the columnar objects.

The following table explains the options available

TABLE 11-3 SNMP Properties

Option	Functions for SNMP Properties
Page	It has two options - origin and index. If the option origin is enabled, the table retrieval is done from the origin. If the index is enabled, the user can set an index value in the adjacent text field from which the table is retrieved.
Host	The value set here overrides the host name set in the Mib Browser settings dialog box.

TABLE 11-3 SNMP Properties (Continued)

Option	Functions for SNMP Properties
Settings	Pops up another dialog box in which the following options can be set. Polling Interval - sets the polling interval for the retrieval of the tables. By default, it is 5 seconds. Page Size (Rows) - sets the number of rows to be retrieved. No of Column View - sets the number of columns to be displayed in the SNMP Table - Panel. Default is 5 columns. Port No - sets the port number to which the request is made. SNMP version - allows selecting the desired versions of the SNMP. Retrieval Mode - sets the mode of retrieval for fetching the SNMP tables. By default, it is by GET NEXT. If the SNMP version is v2c or v3, GET BULK also can be used.
Start	Starts the retrieval of the table.
Next, Prev	Navigate the pages (rows) of the table.
StartPolling	Start polling of the table. Based on the polling interval value set in the settings option, it retrieves the table periodically.
StopPolling	Stop polling.
Refresh	When you don't use the polling option, click Refresh to refresh the table.
Add	Add a row to the table. Selecting this pops up another window through which the table values can be added.
Delete	Delete a row from the table.
Graph	Pops up a graph window and starts plotting the selected variable.
Original Table	Replaces the existing table data with the augmented table data. In a table, if one of the index columns is an external index, i.e., the index value is shared by some other table, and then the table is called an Augmented table. Augmented table comes into picture when there is a one-to-one dependency between rows of two tables. This situation might arise when a particular MIB imports another MIB and shares a single table. For example, ifXTable defined in IF-MIB is an augmented table, which has an external index ifIndex augmented from ifTable. Clicking the 'Augmented Table' button shows the columns of the table which augments the index from the original table.
Index Editor	Edit and set the index value of the table.

By right-clicking the table header (where the column name is displayed), a menu appears with the following options:

- *view column node details*
- *edit the header name of the selected column*
- *view Graph for selected cells*
- *add a new row to the table*
- *delete the selected rows from the table*
- *view the not-accessible index*

Using SNMP table, the SET operation for the table variables becomes easier. To set values for the table variables, the following steps need to be followed:

For creating a new row in a table, do the following:

1. In your MIB Module, include a table with RowStatus object defined.
2. Define a column in the table with SYNTAX RowStatus.
3. Load the MIB Module in the MibBrowser.
4. Select the table node from the tree and the table button on the toolbar. It displays the corresponding table.

5. Right-click the table header, and then select the *add a new row to the table* option. This displays a window for entering the values of the table.
6. Set the value for the column with RowStatus syntax to 4 for creating a new row, and then enter the values.

Note: If the RowStatus is not present in the table definition, then you can only modify the existing row by double-clicking the corresponding cell in the table.

7. Click **OK** after entering all the values.

11.7 Trap Viewer

Trap Viewer is used for receiving the traps. Using this you can view the incoming traps to the specified port. The traps can be sent from any host. The port number and the community name have to be set in the Trap Viewer. The trap originator should send the trap to the port number specified in the Trap Viewer.

The trap viewer is accessed using the **View -> Trap Viewer** menu option. This displays in a table format, as shown in the following figure.

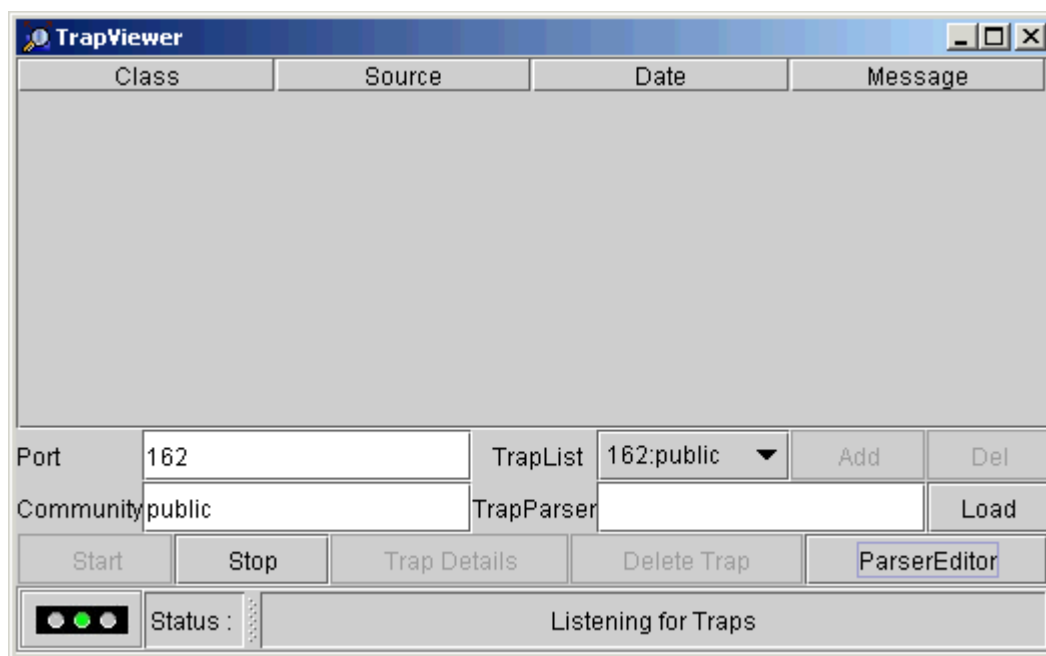

FIGURE 11-5 Trap Viewer

The trap viewer components are:

- Trap Table, in which the incoming traps are listed.
- A **Port** text field to specify the port on which the viewer will listen.
- A **Community** text field to specify the community of the incoming traps.
- A **TrapList** combo box, which contains the Port and Community list on which the trap has to listen.
- Field to load the Trap Parser file.
- **Start** and **Stop** buttons.
- Button to view the trap details.
- **Delete Trap** button to delete a trap from the Trap Table.
- Trap Parser editor.

The trap table has the following properties:

- Class - Defines the Severity of the Trap.
- Source - Displays the IP address of the source from where the trap was send.
- Date - Displays the date of receiving the trap.
- Message - By default, contains the VarBind list of the Trap, if any, else it is blank.

To view more details of the received trap, right-click a table entry and choose View Trap Details. Sorting of trap table columns is done by clicking the corresponding columns.

Trap Details shows more details about the incoming trap. Properties are shown in the following table.

TABLE 11-4 Trap Properties

Property	Description for Trap Properties
Time Stamp	The Time Ticks value is converted into hours, minutes and seconds.
Enterprise	This field contains the enterprise OID.
Generic Type	This field can have values from 0-6, depending on the type of traps.
Specific Type	This field can have values from 1-64K.
Message	By default, this field will always contain the Varbinds in the Trap PDU. This can be substituted with text.
Severity	This field shows the severity of the trap. Default is Clear.
Entity	The source IP address from which the Trap originated.
RemotePort	The port on which the Trap was sent by the originator.
Category	Community string.
Domain	Source of the originator.
Network	The network (192.168.4.2) to which the device that generates the trap belongs.
Node	The device that generates the trap.
Source	The component or the element in the device that generates the trap.
Time Received	The time of receiving the trap.
HelpURL	Gives more details of the received trap. By default, the URL file name is <generic-type value> - <specific-type value>.html.

The Trap Viewer can filter incoming trap according to certain criteria called the Parser Criteria. The Trap Viewer shows only those traps that matches the Trap Criteria. The rest are dropped and is not shown to the user. The Criteria can be configured using the Trap Parser Editor.

11.8 Trap Parser

11.8.1 Overview

Trap Parser is a tool for creating trap parser files. The Trap Parser Editor is used to configure and parse the trap events. Since Traps typically contain cryptic information not easily understandable to the users, trap parsers are required to translate or parse traps into understandable information.

To view the Trap Parser Editor, click **ParserEditor** in the Trap Viewer window. Refer to the following figure. Use the Next button to view the options.

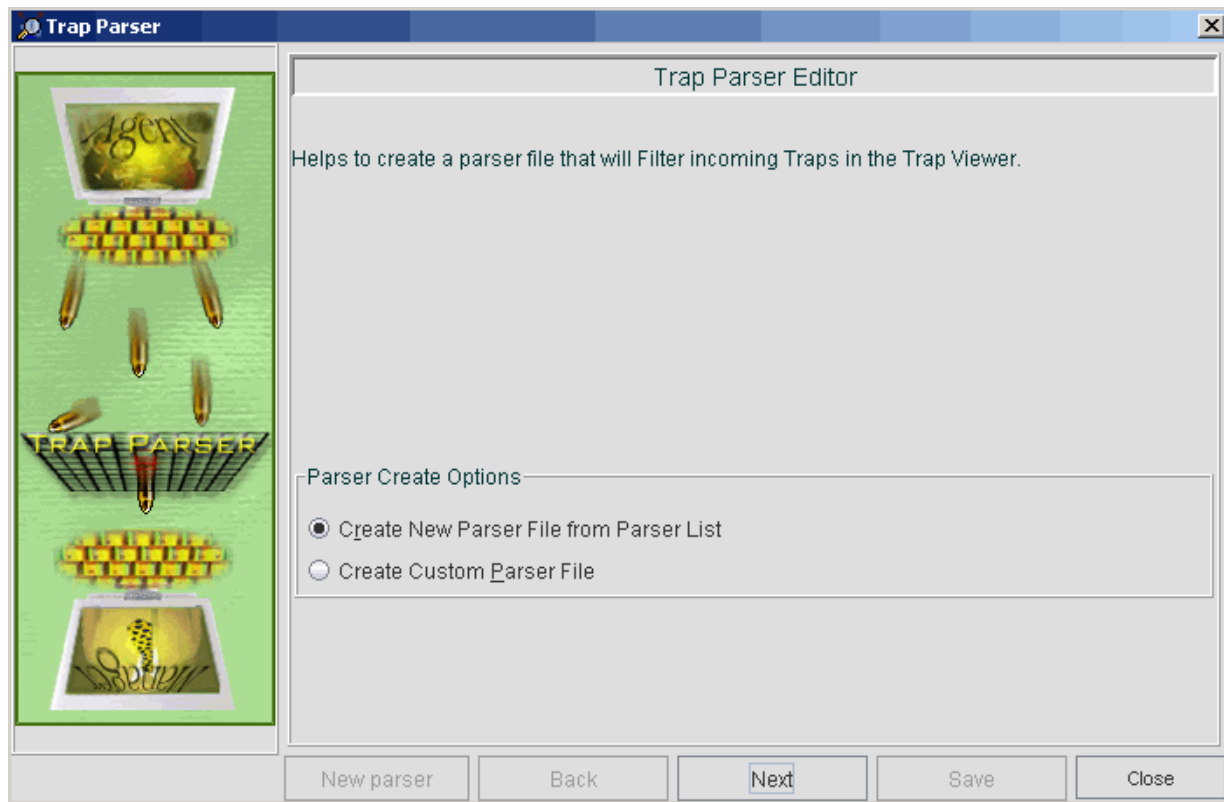

FIGURE 11-6 Trap Parser Editor

Each incoming trap must have the Match Criteria to show the traps in the Trap Table.

You may enter any number of parser match criteria into a single parser file with a different parser name. The Trap Viewer looks for a match criterion sequentially. Thus, if a match is found for a received trap, the trap is shown on the Trap Table. Once the criterion is matched for a trap, an event is fired, which shows a trap entry in the trap table and further checking of match criteria in the loaded parser file is skipped.

While listening to traps, only one parser file can be loaded by the Trap Viewer. A parser file can have any number of match criteria to match. The Trap Viewer checks all the match criteria in a trap parser file until one is found.

The Match Criteria are:

- Generic Type - Each trap has a generic type number. This number must be specified for the trap parser and only when this matches, the trap parser be applied to a trap. The only exception is that when the generic field is left blank or filled with negative value, the trap is allowed to be parsed. The values for generic type ranges from 0 to 6.
 - 0 - cold start
 - 1 - warm start
 - 2 - linkdown
 - 3 - linkup
 - 4 - authentication failure
 - 5 - egpNeighbourloss
 - 6 is for enterprise specific
- Specific Type - This field can have values from 0-64k. When this field is to be matched, the Generic Type must always be enterprise specific.

- Enterprise OID - The enterprise field is the SNMP enterprise identifier in the trap, which is used to uniquely identify traps for a particular application. The parser is applied only when the trap enterprise field starts with the enterprise field you specify. The only exception is that when the enterprise field is left blank, the trap is allowed to be parsed.
- OID and Value - This extends the match criteria. There must be a match for all the OID:Value pairs (specified in the list box) in the Trap PDU of the receiving trap.
- Agent and Port - This also extends the match criteria. The trap must be sent by an Agent specified in the Agent:Port list box. If the Port is 0, then the source can send the trap from any port.

For each match criterion, a name is given called the Trap Name. The fields in the event details are configured in the Output Event Parameters section. Once the Trap is matched by the match criteria, the trap is added to the Trap Table. The Output Event parameters are shown as the Trap Details, which gives more specific information regarding the trap.

By default, some of the field of the Output Event parameters are filled by a variable called parser variables, usually starting with \$. These variables substitute a specific characteristic of the parser in the Trap Details.

Values for field are:

- \$Community - This token is replaced by the community string of the received trap.
- \$Source - This token is replaced by the source name/address of the received trap.
- \$Enterprise - This token is replaced by the enterprise ID of the received trap.
- \$Agent - This token is replaced by the agent address of the received trap.
- \$SpecificType - This token is replaced by the specific type of the received trap.
- \$GenericType - This token is replaced by the generic type of the received trap.
- \$Uptime - This token is replaced by the uptime value in the received trap.
- \$* - This token is replaced by all the variable bindings of the received trap, including the OID and the variable values of each variable binding.
- \$# - This token is replaced by all the SNMP variable values in the variable bindings of the received trap.
- \$N - This token is replaced by the (N-1) SNMP variable value in the variable bindings of the received trap.
- @* - This token is replaced by all the OID values in the variable bindings of the received trap.
- @N - This token is replaced by the (N-1) OID value in the variable bindings of the received trap.

11.8.2 Procedure to Create a Parser File

1. Click **ParserEditor** in the Trap Viewer.
2. Enter the Match Criteria, which includes Trap Parser Name, Generic Type, Specific Type, Enterprise OID, OID and Value pair (optional) and Agent and port pair (optional). (The Generic Type - means, it will match any value for this field).
3. Click the OutPut Event Parameters tab and fill in the event parameters. These include Severity, Failure Object, Community, Node, Source, Help URL, Message, and Severity Color. If left blank, the following fields will default as follows:
 - **Community** - Name
 - **Node** - \$Source
 - **Source** - \$Source
 - **Help URL** - \$GenericType-\$SpecificType.html
 - **Message** - \$*
4. Click **Add** to add the Trap parser to the Parser List.
5. Repeat from Step 1 to add more Match Criteria for incoming Traps.
6. Save the current parser criteria into a parser file using the **Save** button.
7. After saving, the parser file is displayed on the Parser File text field.
8. Close the Trap Parser Editor. A parser file is now created.

11.8.3 Adding a Trap Definition from MIBs to a Parser File:

1. Choose the MIB file (standard or any other) in the MIB File text field.
2. The setting of the MIB is automatically shown on the MatchCriteria and Output Event parameters sections.

If any modification is made after saving to a file, you must click **Mod** below the Trap list box, and then choose the same file from the **Save** option. This saves the modified information into the same file.

11.8.4 Filtering Incoming Traps

1. Create the parser file.
2. In the Trap Viewer window, load the parser file that is created.

*Note: The parser files are saved with **.parser** extensions*

3. Start the Trap Viewer. Now, the Trap Viewer will filter all the incoming traps according to the Match Criteria.

11.8.5 Setting Trap Parser Parameters

The following are some important fields and information on how to configure them for a given trap.

- name - The name of the parser.
- severity - This is used to specify the state of an event, which determines the severity shown in the ListTraps. This severity determines how a fault is affected by this event. The type of this field is an integer ranging from 0 to 6.
 - 0 is for All.
 - 1 is for Critical.
 - 2 is for Major.
 - 3 is for Minor.
 - 4 is for Warning.
 - 5 is for Clear.
 - 6 is for Info. By default 6 will be assigned.
- textDefn - This is the message text seen for this event in the ListTraps and logs.
- categoryDefn - This is a type of the trap that can be used to categorize trap events.
- helpDefn - The associated document for this trap.
- ST - This is the specific type of the trap that has values from 0-64K.
- GT - This is the generic type of the trap that has values from 0-6.
- enterprise - This is the enterprise OID of the trap.

For example, you can try the following:

This command sends the trap using the sendtrap application (from the agent 192.168.1.1 at port 4001).

```
Input: java sendtrap -p 4001 -c public -m mibs/RFC-1213 192.168.1.1
      .1.3.6.1.2.1.1.1.0 192.168.1.1 0 0 1000 .1.3.6.1.2.1.1.1.0 xyz
```

This matches the Match Criteria of the Trap Parser if it is:

- Generic Type - 0
- Specific Type - 0
- Enterprise oid - .1.3.1.6.1.2.1.1.1.0
- Oid - .1.3.6.1.2.1.1.1.0
- Value - xyz

- Agent - 192.168.1.1
- Port - 4001

The TrapParser gets trap from any trap originator and parses the trap event.

11.9 Graphs

The Mib Browser enables a real-time plotting of SNMP data on a graph. Currently, two types of graph are supported: line graph and bar graph. The SNMP data to be polled should be of integer or unsigned integer data type. Typically, the values that are plotted are of type Counter, Gauge, or Timeticks.

The steps listed below should be followed for plotting the SNMP data in the graph:

1. Ensure the appropriate MIBs have been loaded.
2. Specify the proper agent host name or IP address in the host field of the Mib Browser.
3. Specify a valid variable. The variable needs to be an integer or unsigned integer (Counter, Gauge or Timeticks). The variable can be chosen by browsing the MIB in the MibTree.

After selecting the variable from the MibTree, click the **GRAPH** icon or select the menu item Line Graph or Bar Graph from the View menu. This brings an automatically updated graph, showing the results of periodically polling the specified agent for the specified OID. By default, polling for the graph is done every 5 seconds.

The following options can be configured for the graph:

- Polling Interval - Default value is 5 seconds: editable, can be given any value.
- Average over Interval - By default, the graph shows the actual values of a variable for different hosts. In other words, the values of the specified OID are plotted for different hosts for the given polling interval. This option is used to take the average of the values at a given polling interval for plotting the graph.
- X axis scale - Allows to set the X axis scale; the minimum is 300 secs.
- Show Absolute Time - If selected, it shows the time in hrs:secs otherwise in seconds.
- Max X value - Allows to set the maximum time the graph can plot. The default maximum value is 3600 secs.
- Show Polled Values - If selected, it shows all the polled values in a particular time period. By default, it is disabled.
- Log File Name - The filename for the log file can be set here. By default, the log filename is graph.txt. If **Log Polled Values** is selected, all the polled values are logged in this file. This option is not enabled when the MibBrowser runs as an applet because of security restrictions.
- Log Polled Values - If selected, it logs the polled values. By default, it is disabled.
- Show absolute counters - To enable the plotting of the absolute value. By default, the graph plots only the difference between the two values.
- The **Stop** button can be used to stop the polling of the variable. The **Restart** button can be used to restart the polling. The **Close** button is used to close the graph window.

The Mib Browser can plot multiple graphs showing values for different variables from different hosts.

11.10 CWMP

The CPE WAN Management Protocol (CWMP) is a messaging protocol designed for communication between the CPE devices and the management system. Specifications for this protocol are written by The Broadband Forum (formally DSL Forum) in technical reports, and the TR-069 defines the messaging format based on XML for communicating using CWMP.

Previously, the discovery process and also all NMS supported operations used CLI or SNMP to communicate to the devices. Now TR-069 operations can be performed on Comtrend CPEs and ATI NextGen iMG devices. Although not all operations are implemented, there is a generic TR-069 client application implemented that can be used to execute any of the TR-069 operations described in the specification.

To access this tool, select under the Tools menu *CWMP Browser*. Refer to the following figure.

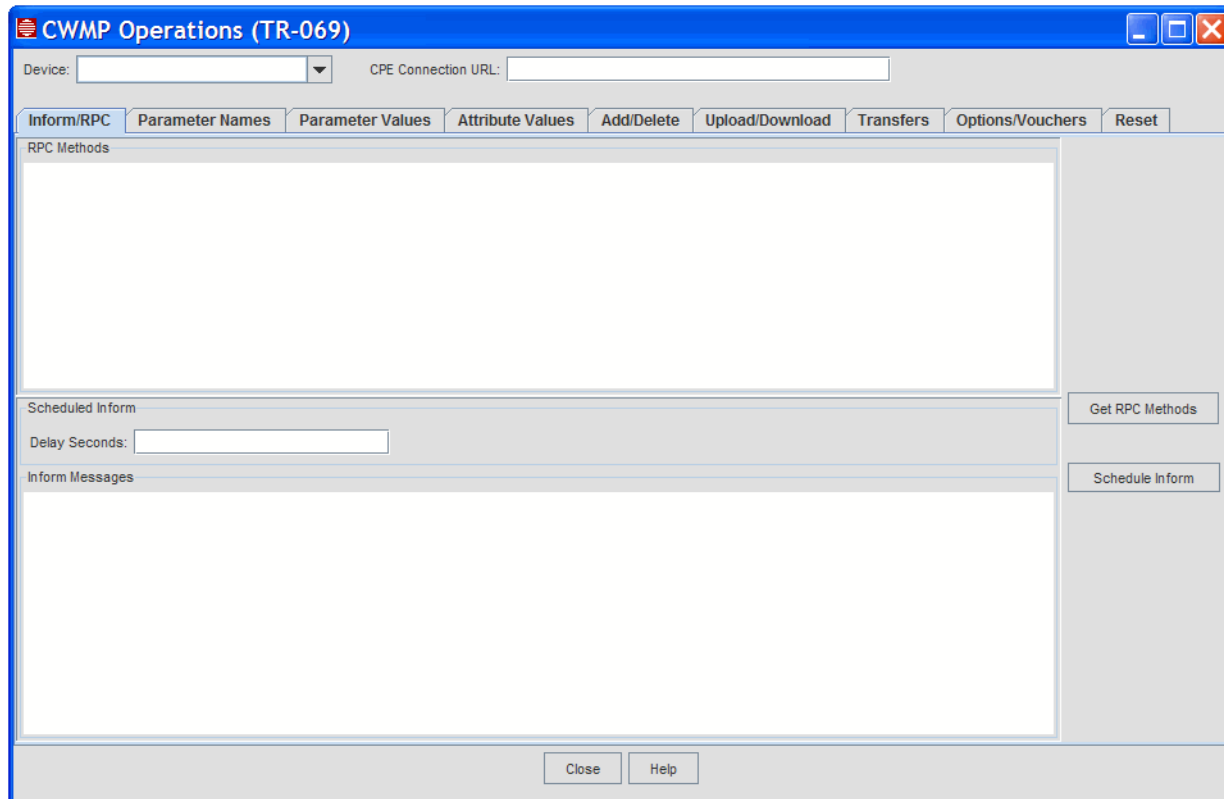

FIGURE 11-7 CWMP Browser - Initial Screen

.If any devices managed using TR-069 have been discovered using the NMS, they will appear in the Device pull-down. The Connection URL is the URL on the CPE the Auto Configuration Server (ACS) can use to initiate a connection. (This is done when using the Comtrend or RG Boot Configurator.) Also, the IP address of the ACS (the NMS being used) must be provisioned by accessing the device (using the client's browser, for example). Error messages may occur if these are not present.

The tabs and buttons follow the operations of the TR-069 specification.

12. Northbound Interface

12.1 Overview

A northbound interface on an NMS/EMS allows other software applications (higher level network management systems) to communicate with (or manage) the lower level NMS without the user acting on the lower level NMS directly. In many cases this interface is intended for higher level network management systems communicating with devices from different vendors (with vendor specific device communication interfaces) using element management systems from those vendors that provide a well known interface that can be used by the higher level network management software.

There are several platform-independent technologies of software communication used to implement the northbound interface (e.g. CORBA, XML, RMI, etc.) and Apache Axis will be used to provide the northbound interface in AlliedView NMS. Axis is an implementation of SOAP (Simple Object Access Protocol) which is not only XML based but also provides APIs that support web services standards.

The following table lists the capabilities for the northbound interface APIs. **Note that read and provisioning operations are available in release 10.0.**

TABLE 12-1 Northbound Interface APIs for Release 10.0

Capability	Detail
Retrieve network inventory objects from NMS based on criteria set by the client.	Provide APIs for retrieving network inventory data based on type and allow client application to specify other criteria. In addition the API will allow clients to retrieve any other network inventory data from the NMS by specifying the matching criteria.
Retrieve network events available in NMS database based on criteria set by the client.	Allow clients to retrieve network events from the NMS. The client can specify criteria of the network events to be retrieved. Only events that match the selected criteria will be retrieved.
Retrieve alarms available in NMS database based on criteria set by the client.	Allow clients to retrieve alarms from the NMS. The client can specify criteria of the alarms to be retrieved. Only alarms that match the selected criteria will be retrieved.
Retrieve network events and alert filters that are currently configured in NMS.	Allow clients to retrieve all event and alert filters configured in NMS. These filters in NMS could be setup to perform certain operations when a new event or alert is received.
Retrieve trap and events parsers that are currently configured in NMS.	Allow clients to retrieve all trap and event parsers configured in NMS. These parsers in NMS are used to modify any properties of the trap or event in NMS (by default these are used to set the severity)
Retrieve the number of network events or alarms in the NMS.	Allow clients to retrieve total counts for all events and alarms from the NMS. Alarm counts can also be retrieved for the specified severity.
Retrieve the history of an alarm	The NMS maintains the history of an alarm based on failure object (entity) which will be available through this API. The client will specify the failure object of the alert to get the history.

TABLE 12-1 Northbound Interface APIs for Release 10.0

Capability	Detail
Autonomous events configuration for clients	allow clients to receive network events from the NMS immediately without the need for the client to poll the NMS every time. The client will configure the NMS with the information required (including criteria if only specific events are needed) and the NMS will forward all events that match the criteria
Retrieve device information from the device through the NMS	All other operations in this release operate on the NMS with the results available in the NMS server. This operation will use the NMS to retrieve the data from the device. Device data is retrieved using CLI or SNMP. The main purpose for this is to evaluate how other device operations can be supported
Users accessing northbound interface must be authenticated and denied access if not authorized.	Operations done through the northbound interface will have access to the NMS database and devices, therefore access should be restricted using the users in NMS security database
Retrieve stored customer information from device	Once the configuration is complete the northbound interface is expected to have an API to retrieve the configured information from the device. This can be used to allow clients to validate parameters or display subscribed services.
Provision a triple play customer.	Allows northbound interface clients to provision triple play services for a customer using iMAP device and RG or iMG device.
Provision a customer port on device	Allows northbound interface clients to provision a customer port on iMAP device without provisioning the RG or iMG device.
Provision a customer RG or iMG device	Allows northbound interface clients to provision services on the RG for a customer when the port where the RG is connected was provisioned separately.
De-provision a triple play customer.	Allows northbound interface clients to de-provision triple play services for a customer on iMAP device and RG or iMG device through the API. The iMAP port and RG can also be de-provisioned separately.
Modify Customer provision information.	Allows northbound interface clients to modify selected provision information for the customer. Configuration information that can be modified is similar to what was used in provisioning.
Perform a bulk provision task (provision many customers from saved data)	Allows provision, de-provision or modify configuration of many customers by loading the information from a file. The client in NMS that has limited bulk provision operations is currently using RMI and is updated to use northbound operations.

12.2 SOAP Implementation

12.2.1 Overview (Apache Axis)

Apache Axis is able to provide web services, and as a successor of SOAP, it has the simplicity for hiding all XML details from the users implementing the service or clients. Administrators can find detailed information on Axis/SOAP at www.apache.org.

Note: Apache Axis is described here because the AlliedView NMS server implementation is based on Apache Axis for SOAP communication. Other web service tools besides Axis could be used.

Note: Axis 1 (1.4) does not support callback operations and is considered slower compared to other technologies such as CORBA because it uses HTTP as the protocol and text (XML) data. Axis 2 (currently in beta version) is expected to be an improvement of its predecessor.

Note: With a standard northbound interface, the higher level NMS would not have to implement different clients to communicate with NMS/EMS from different vendors. However, specific interfaces may be more useful to the client because operations will be specific to clients' needs.

12.2.2 WSDL

WSDL is a language used to describe the services published by an interface. When publishing Axis web services, the server will include interfaces and implementations and publish the WSDL file which will include descriptions of all available operations, parameters and return types.

Note: The WSDL in Axis/SOAP is considered equivalent of the IDL in CORBA.

On the client side the implementation can start by looking at the WSDL file to determine available services, generate stub code from WSDL then implement the client to use the services. As an alternative client implementation can skip client code generation and manually implement client code that calls Axis directly (this can be complicated if the developer is not familiar with Axis/SOAP core classes). There are tools already available that can be used to parse WSDL files and generate stubs and skeleton code for different language implementations.

For the WSDL path for AlliedView NMS, use <http://<nmsserver-IP>:9090/axis/services>

Client programs intended for performing operations on NMS using this interface can be implemented in any language that supports SOAP; however languages that do not support HashMaps will be limited to operations that do not take a HashMap as a parameter or return it as results. The WSDL file provided contains all operations available and the client program developer will need to use it to get the correct syntax of operations and details provided here will be useful explaining object contents.

12.2.3 Web Services

Web services are essentially application interfaces available for communication with other programs that can be done through the web (HTTP server). The northbound interface in NMS will be available through the web server and can be executed from anywhere if the server is accessible from the internet. The APIs and features exposed will also be referred to as web services.

The following figure shows how Axis/Soap clients fit into the client/server model. Among other processes running in the NMS server are the web server and servlet container which are used to service Axis requests. Axis/SOAP client communicates with the web server which forwards the request to Tomcat container and returns the results for the operation from the container to the Axis client. Other clients also use Apache and Tomcat i.e. Java clients use HTTP server and servlets to launch WebStart and Applet clients and HTML clients use the HTTP server for HTML pages and Tomcat container to process JSP requests.

Axis/SOAP transports data using XML sent over HTTP. SOAP converts the client requests to XML and sends it to the HTTP server, which forwards the request to Tomcat container. The response is also converted to XML from the container before returned to client and the client converts it back from XML to objects expected by the client

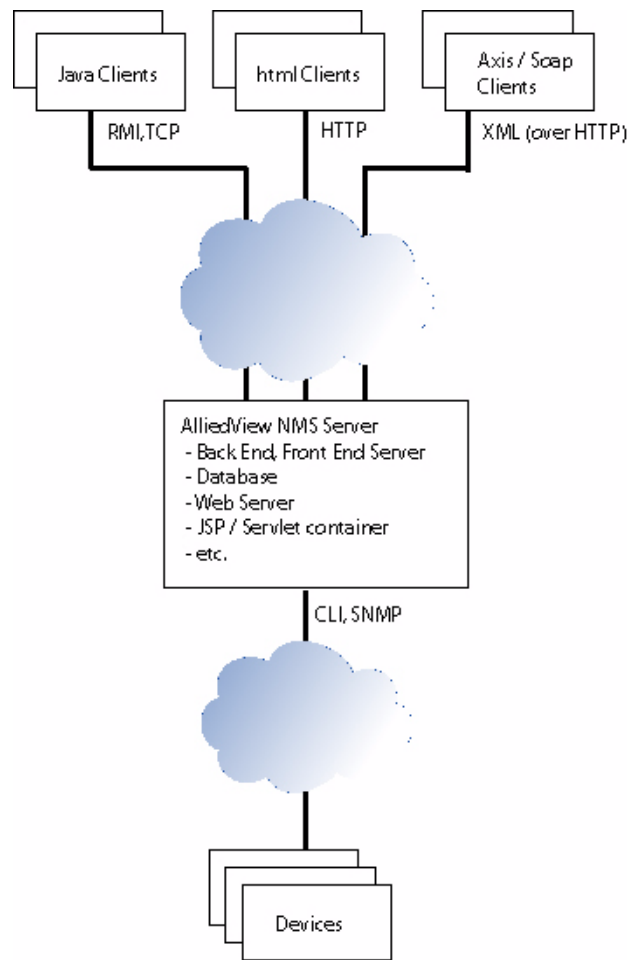

FIGURE 12-1 Client / Server Model for AlliedView NMS

12.3 User Interaction

12.3.1 Web Services Activation

Web services in NMS will not be activated by default and can be activated at runtime when needed by the NMS administrator. When not in use the administrator can also deactivate web services provided by NMS. The script `AT_WebService.bat/sh` can be used to enable and disable the APIs when executed as below. Note that restarting the server is not required when activating/deactivating NMS web services APIs and the server must be running when performing these tasks.

12.3.1.1 Activate Web Services (Axis/SOAP)

This operation must be done after the server is started.

1. Change directories to `<NMS_HOME>/bin`
2. Execute `AT_WebService.bat/sh` with 'deploy' parameter
 - `AT_WebService.bat deploy` (for Windows installations)
 - `AT_WebService.sh deploy` (for Solaris installations)

12.3.1.2 Review the Associated WSDL and Available Services

Use `http://<nmsserver-IP>:9090/axis/services` to see the WSDL and the services available. Note that a relevant file is available only after activating the web services.

12.3.1.3 Deactivate Web Services (Axis/SOAP)

This operation must be done after the server is started.

1. Change directories to `<NMS_HOME>/bin`
2. Execute `AT_WebService.bat/sh` with 'undeploy' parameter
 - `AT_WebService.bat undeploy` (for Windows installations)
 - `AT_WebService.sh undeploy` (for Solaris installations)

12.3.2 User Security

Security will use existing security concepts, which requires a correct user and password and the user must be authorized to perform the requested operation. Audit trails will be logged only in operations that make modification to NMS or devices (e.g. `setEventTarget` and `removeEventTarget` in this release).

In NMS there are several operations that are not restricted to any user and the default behavior will be used for their corresponding web service operation. All northbound APIs that have corresponding operations already in NMS will use the security restrictions for those operations. If the user could not be authenticated (invalid user and/or password) or if not authorized to perform the requested operation, the operation fails and the client will get an `AxisFault` exception with the failure reason.

12.3.3 Operation Threshold Activation

The administrator can set the threshold that allows the specified number of operations to be executed over a specific time interval. This is intended to reduce the server load from processing excessive number of operations and affecting other services. This should be done after the administrator and those implementing clients for this interface decide on what thresholds are acceptable based on the NMS server usage. When thresholds are exceeded the next operations will be denied and stricter restrictions will be enforced until operation execution rate is reduced to current restriction before returning to normal execution rate. By default this feature is not activated and all web service operations will be processed normally.

12.3.3.1 Activate

Create (or edit) a file `NMS_HOME/conf/AT_tmp_conf.properties` and specify the properties, then restart the NMS server:

- `WS_PROCESS_COUNT=<number>` - (for operations count)
- `WS_INTERVAL=<number>` - (for time interval in seconds)

12.3.3.2 Deactivate

To deactivate, comment out the entries in the file above by using the `#` character in the beginning of the line (or delete the file if those are the only two entries), then restart the server

12.3.4 Axis/SOAP Interface Client Development - Examples

Client programs intended for performing operations on NMS using this interface can be implemented in any language that supports SOAP; however languages that do not support HashMaps will be limited to operations that do not take a `HashMap` as a parameter or return it as results. The WSDL file provided contains all operations available and the client program developer will need to use it to get the correct syntax of operations and details provided here will be useful explaining object contents.

12.3.4.1 Client Implementation

There are several ways to implement a client program and several tools are also available to simplify web services development. Here are some examples:

- Use the WSDL provided with client code generator tools (e.g. wsdl2java, wsdl2cpp, etc.) to generate client stub source code for the client to use when calling remote objects. (faster and easier to follow)
- Use an IDE software packages that read the WSDL and guide the client development based on the available interface. (can be slow for experienced programmers)
- Develop the client that manually calls SOAP classes and pass all operation and parameters for the operation. (Requires more SOAP understanding and good if you need to access the SOAP message properties directly.)

12.3.4.2 Example Class (Java)

This example will use Java but other languages have a similar mechanism to generate stub source code and here the example will use Inventory module in NMS

1. Activate the available web services in NMS (refer to [12.3.1.1](#)).
2. Point the browser to web services URL path on NMS server to see the deployed services and get the Inventory WSDL contents into a file (Inventory.wsdl).
3. Run the wsdl2java tool with Inventory.wsdl (See Java or Axis/SOAP documentation) to generate stubs (you will then have at least InventoryService, InventorySoapBindingStub and InventoryInterface classes).
4. The generated classes have all the information needed to access the NMS web service Write the client code to use the generated classes (see example below) with the correct parameters.
5. Compile your class together with the generated classes and run your code that calls web services.

12.3.4.3 Accessing Examples

A complete set of examples is included with release 10.0 in the <NMS_home>/examples directory. There is the nb_examples.zip file, which when extracted contains a set of guidelines and examples. Open the readme text file first.

12.3.5 Available Operations

There are many operations available through northbound interface in NMS with different parameter and results types. The WSDL defines the syntax of all parameters and results but does not define what is the 'Object' included in Lists (object arrays) or HashMaps which have different values based on operation. However, when used in parameters generally Lists will contain a collection of string objects and HashMaps will contain key/value pairs which are both string objects.

Many of the operations that take a HashMap parameter as a filter criteria will accept a '*' anywhere in the string and a '!' at the beginning of the string with their respective meanings when matching the criteria.

The table below show details of available operations in release 9.0 and the key words listed here will be used in the table. Properties of objects used are as they are stored in NMS database or retrieved from device and multiple parameters are listed as they appear.

- MO match criteria: A HashMap of match criteria key/value pairs using Managed Object properties (e.g. category=Rapier, type=9700 etc.). Criteria can be left empty to match anything or use selected special characters mentioned above (some operations require match to specific devices).
- List of object properties: A list (array of objects) with each element containing properties of one object in a HashMap
- Provision properties: A map of parameters used in provisioning the device (see [12.3.6](#) for the list)

TABLE 12-2 Operations Table

Module / Operation	Parameters Types	Return Types	Notes
Inventory/ getNode-Names	<i>MO match criteria</i> (Nodes)	List of node names	Returns a list of node names matching the criteria
Inventory/ getNetworks	<i>MO match criteria</i> (Networks)	<i>List of object properties</i> (Networks)	Return a list of network object properties matching the criteria

TABLE 12-2 Operations Table

Module / Operation	Parameters Types	Return Types	Notes
Inventory/ getNodes	<i>MO match criteria</i> (Nodes)	<i>List of object properties</i> (Nodes)	Return a list of node object properties matching the criteria
Inventory/ getCards	<i>MO match criteria</i> (Cards)	<i>List of object properties</i> (Cards)	Return a list of node object properties matching the criteria
Inventory/ getPorts	<i>MO match criteria</i> (Ports)	<i>List of object properties</i> (Ports)	Return a list of port object properties matching the criteria
Inventory/ getIpInterfaces	<i>MO match criteria</i> (IP interfaces)	<i>List of object properties</i> (IP interface)	Return a list of IP interface object properties matching the criteria
Inventory/ getVlanInterfaces	<i>MO match criteria</i> (VLAN interfaces)	<i>List of object properties</i> (VLAN interfaces)	Return a list of VLAN interface object properties matching the criteria
Inventory/ getVlans	<i>MO match criteria</i> (VLANs)	<i>List of object properties</i> (VLANs)	Return a list of VLAN object properties matching the criteria
Inventory/ getPhysicalLinks	<i>MO match criteria</i> (Physical links)	<i>List of object properties</i> (Physical links)	Return a list of physical link object properties matching the criteria
Inventory/ getEpsrDomains	<i>MO match criteria</i> (EPSR domains)	<i>List of object properties</i> (EPSR domains)	Return a list of EPSR domain object properties matching the criteria
Inventory/ getProfiles	<i>MO match criteria</i> (Profiles)	<i>List of object properties</i> (Profiles)	Return a list of profile object properties matching the criteria
Inventory/ getTasks	<i>MO match criteria</i> (Tasks)	<i>List of object properties</i> (Tasks)	Return a list of task object properties matching the criteria
Inventory/ getInventory-Objects	<i>MO match criteria</i> (any MO objects types)	<i>List of object properties</i> (any objects types)	Return a list of any object properties matching the criteria
Inventory/ getDiscovery-Properties	None	HashMap of discovery properties	Returns discovery configuration properties
Faults/ getTotalEventsCount	None	Total events count (integer)	Returns total number of events
Faults/ getEvents	HashMap of event properties match criteria	List of event properties (list of HashMaps)	Returns a list of event properties matching the criteria
Faults/ getEventFilters	None	HashMap of event filters with each filter containing a HashMap that has criteria and actions. Criteria contain strings and an action contains a HashMap with different actions.	Returns a HashMap of event filters. This Map contains other HashMaps for criteria and actions and also actions contain other HashMaps for each action.
Faults/ getEventParsers	None	List of event parser properties (list of HashMaps)	Returns a list of event parsers properties
Faults/ getTrapParsers	None	List of trap parser properties (list of HashMaps)	Returns a list of trap filter properties

TABLE 12-2 Operations Table

Module / Operation	Parameters Types	Return Types	Notes
Faults/ setEventTarget	- Target server IP address - Target server port number - HashMap of event properties match criteria	None	Sets up a target server and port as a receiver of events that match the specified criteria.
Faults/ removeEventTarget	- Target server IP address - Target server port number	None	Remove the server with address and port from events receiver.
Faults/ getEventTargets	None	HashMap of event targets which also shows counts	Returns the configured event target hosts and ports.
Faults/ getTotalAlertsCount	None	Total alarms count (integer)	Returns total number of alarms
Faults/ getAlertsCount	Severity string (e.g. Critical, Major, etc.)	Alarms count with the severity.	Returns the number of alarms matching the specified severity
Faults/ getAlerts	HashMap of alarm properties match criteria	List of alarm properties (list of HashMaps)	Returns a list of alarm properties matching the criteria
Faults/ getAlertFilters	None	HashMap of alarm filters with each filter containing a HashMap that has criteria and actions. Criteria contain strings and an action contains a HashMap with different actions.	Returns a HashMap of alarm filters. This Map contains other HashMaps for criteria and actions and also actions contain other HashMaps for each action.
Faults/ getAlertAnnotation	Failure object (entity) of the alarm	List of annotation properties for the alarm (list of HashMaps)	Returns a list of annotations for the alarm with the specified entity.
Faults/ getAlertHistory	Failure object (entity) of the alarm	List of history properties for the alarm (list of HashMaps)	Returns a list of history for the alarm with the specified entity.
Mdti/ getDeviceInfo	Device IP address (a in NMS database)	HashMap or device general information properties	Returns device general information from the device. This retrieves results from the device (not database).
Mdti/ getMultiDeviceInfo	Device IP addresses (separated by ',')	List of properties (list of HashMaps)	Returns a list of device general information properties
Provision/ getDeviceInterfaces	- Device IP address - Port number	A map of parameters of the interface specified	Returns current values from the device (if ALL is specified then values returned will be for all ports)
Provision/ getDeviceVlans	- Device IP address - VLAN ID	A map of properties of the specified VLAN	Returns current values from the device (if ALL is specified then values returned will be for all VLANs)
Provision/ getRGDeviceDetails	- MO match criteria (RGs) - Components list	Map containing properties of the RG	Retrieves properties of RG from the device directly.

TABLE 12-2 Operations Table

Module / Operation	Parameters Types	Return Types	Notes
Provision/ provisionPort	<i>Provision parameters</i>	Status of the operation	Status returned can indicate the operation has started or completed if time-out is specified.
Provision/ deprovisionPort	<i>Provision parameters</i>	Status of the operation	Status returned can indicate the operation has started or completed if time-out is specified.
Provision/ modifyPort	<i>Provision parameters</i>	Status of the operation.	Status returned can indicate the operation has started or completed if time-out is specified
Provision/ modifyRG	- <i>MO match criteria (RGs)</i> - <i>Provision parameters</i>	Status of the operation	Status returned can indicate the operation has started or completed if time-out is specified.

12.3.6 Provision Parameters

Most of the provision operations will use parameters grouped in key/value format (HashMap). Accepted keys are already specified and will need to be used as expected for the operation to be executed; unknown keys will be ignored. Most of these keys have values that are also specific but some will accept user specified values.

The table below contains keys and possible values that can be used with it. Keys selected use names that relate to where they are expected to be used. These parameters are very similar to those that are provisioning windows and used here to configure same parameters on devices. The order of these parameters as they appear in a map does not affect the execution of the operation and there are more than these included here.

TABLE 12-3 Provision Parameters

Keys	Values	Description
DEVICE	<IP address>	IP address of the iMAP device
SLOT_PORT	<Port number>	Slot and port number of the selected port (X.Y)
PORT_PROFILE	<Port profile name>	RG general profile name
RG_INET_PROFILE	<RG internet profile name>	RG internet profile name
RG_VIDEO_PROFILE	<RG video profile name>	RG video profile name
RG_VOIP_PROFILE	<RG VOIP profile name>	RG VOIP profile name
CUSTOMER_ID	<Customer ID>	Unique customer ID
CUSTOMER_INFO	<Customer info>	Any customer information
PORT_STATUS	(ENABLED/DISABLED)	Enable/Disable iMAP port
DHCP_AGEING	(ON/OFF)	Enable/Disable DHCP ageing on iMAP device
MAX_LEARNED_MAC_ADDRS	(OFF/1..64)	MAC address learn limit
IP_RANGES	<IP filter ranges>	Comma separated IP ranges
MAC_ADDRESSES	<Allowed MAC addresses>	Comma separated list of MAC addresses
TAGGED_VLANS	<Tagged VLANs>	Comma separated list of tagged VLANs for iMAP port

TABLE 12-3 Provision Parameters

Keys	Values	Description
UNTAGGED_VLAN	<Untagged VLAN>	Untagged VLAN for iMAP port
TLS_VLAN	<TLS VLAN>	A VLAN for transparent LAN
PROVISION_DATA	(TRUE/FALSE)	Include iMAP port in provision
DEPROVISION_DATA	(TRUE/FALSE)	Include iMAP port in deprovision
PROVISION_RG	(TRUE/FALSE)	Include RG device in provision
DEPROVISION_RG	(TRUE/FALSE)	Include RG device in deprovision
RG_PROFILE_VLANS	(TRUE/FALSE)	Specify where to use VLANs from RG profiles specified
LOCAL_VLAN	<RG local VLAN>	RG VLAN for local network
LOCAL_IP	<RG local IP address>	RG local network address
LOCAL_MASK	<RG local netmask>	RG local network mask
DHCP_START_IP	<RG local DHCP start IP address>	RG local DHCP start IP address
DHCP_END_IP	<RG local DHCP end IP address>	RG local DHCP end IP address
INET_IP	<RG internet IP address>	RG IP address for internet service if not from DHCP
INET_MASK	<RG internet netmask>	RG netmask for internet service if not from DHCP
VOIP_IP	<RG VOIP IP address>	RG IP address for VOIP service if not from DHCP
VOIP_MASK	<RG VOIP netmask>	RG netmask for VOIP service if not from DHCP
RG_PORT_SERVICE_X	(INTERNET/VIDEO/TLS)	RG Ethernet port service (X is port number)
RG_PORT_SPEED_X	(AUTO/COAX/FULL_100M/HALF_100M/FULL_10M/HALF_10M)	RG Ethernet port speed (X is port number)
RG_PORT_UP_RATE_X	<Port upstream rate>	RG Ethernet port upstream rate in kbps (X is port number)
RG_PORT_DOWN_RATE_X	<Port downstream rate>	RG Ethernet port downstream rate in kbps (X is port number)

13. Appendices

13.1 Exporting Tabular Data

Data displayed in tabular form in the AlliedView NMS can be exported to a file on the NMS server or to your Web browser for viewing. Tabular data appears in the following views:

- Fault Management
- Performance
- Network Inventory

The procedure for exporting tabular data is the same for all of these views.

Note: The one exception is the Performance view; this is explained separately, in 13.1.1.2.

To demonstrate the procedure, the data in the Alarms subview will be exported in this section. The Alarms subview is shown in the following figure.

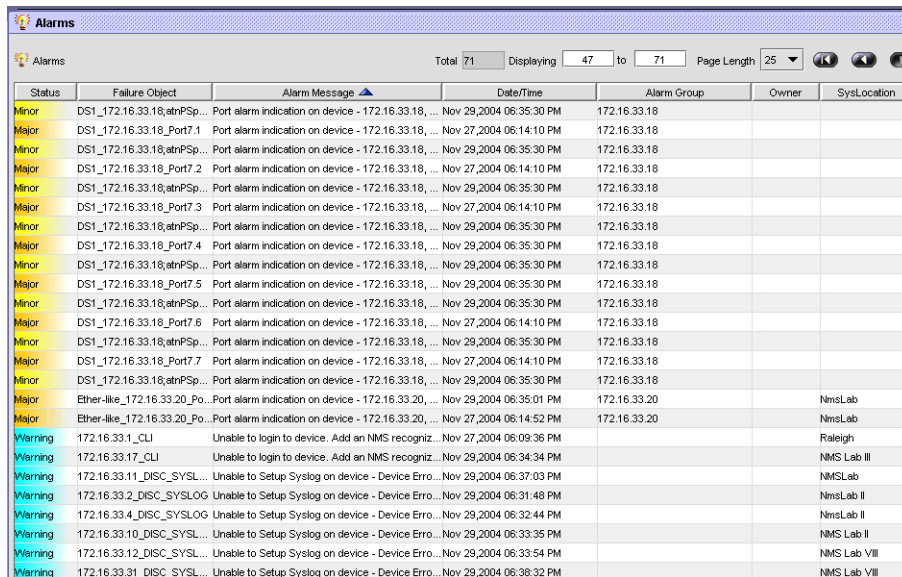

Status	Failure Object	Alarm Message	Date/Time	Alarm Group	Owner	SysLocation
Minor	DS1_172.16.33.18_atnPSp...	Port alarm indication on device - 172.16.33.18, ...	Nov 29,2004 06:35:30 PM	172.16.33.18		
Major	DS1_172.16.33.18_Port7.1	Port alarm indication on device - 172.16.33.18, ...	Nov 27,2004 06:14:10 PM	172.16.33.18		
Minor	DS1_172.16.33.18_atnPSp...	Port alarm indication on device - 172.16.33.18, ...	Nov 29,2004 06:35:30 PM	172.16.33.18		
Minor	DS1_172.16.33.18_Port7.2	Port alarm indication on device - 172.16.33.18, ...	Nov 27,2004 06:14:10 PM	172.16.33.18		
Minor	DS1_172.16.33.18_atnPSp...	Port alarm indication on device - 172.16.33.18, ...	Nov 29,2004 06:35:30 PM	172.16.33.18		
Major	DS1_172.16.33.18_Port7.3	Port alarm indication on device - 172.16.33.18, ...	Nov 27,2004 06:14:10 PM	172.16.33.18		
Minor	DS1_172.16.33.18_atnPSp...	Port alarm indication on device - 172.16.33.18, ...	Nov 29,2004 06:35:30 PM	172.16.33.18		
Major	DS1_172.16.33.18_Port7.4	Port alarm indication on device - 172.16.33.18, ...	Nov 29,2004 06:35:30 PM	172.16.33.18		
Minor	DS1_172.16.33.18_atnPSp...	Port alarm indication on device - 172.16.33.18, ...	Nov 29,2004 06:35:30 PM	172.16.33.18		
Major	DS1_172.16.33.18_Port7.5	Port alarm indication on device - 172.16.33.18, ...	Nov 29,2004 06:35:30 PM	172.16.33.18		
Minor	DS1_172.16.33.18_atnPSp...	Port alarm indication on device - 172.16.33.18, ...	Nov 29,2004 06:35:30 PM	172.16.33.18		
Major	DS1_172.16.33.18_Port7.6	Port alarm indication on device - 172.16.33.18, ...	Nov 27,2004 06:14:10 PM	172.16.33.18		
Minor	DS1_172.16.33.18_atnPSp...	Port alarm indication on device - 172.16.33.18, ...	Nov 29,2004 06:35:30 PM	172.16.33.18		
Major	DS1_172.16.33.18_Port7.7	Port alarm indication on device - 172.16.33.18, ...	Nov 27,2004 06:14:10 PM	172.16.33.18		
Minor	DS1_172.16.33.18_atnPSp...	Port alarm indication on device - 172.16.33.18, ...	Nov 29,2004 06:35:30 PM	172.16.33.18		
Major	Ether-like_172.16.33.20_Po...	Port alarm indication on device - 172.16.33.20, ...	Nov 29,2004 06:35:01 PM	172.16.33.20		NmsLab
Major	Ether-like_172.16.33.20_Po...	Port alarm indication on device - 172.16.33.20, ...	Nov 27,2004 06:14:52 PM	172.16.33.20		NmsLab
Warning	172.16.33.1_CLI	Unable to login to device. Add an NMS recogniz...	Nov 27,2004 06:09:36 PM			Raleigh
Warning	172.16.33.17_CLI	Unable to login to device. Add an NMS recogniz...	Nov 29,2004 06:34:34 PM			NMS Lab III
Warning	172.16.33.11_DISC_SYSL...	Unable to Setup Syslog on device - Device Erro...	Nov 29,2004 06:37:03 PM			NMSLab
Warning	172.16.33.2_DISC_SYSLOG	Unable to Setup Syslog on device - Device Erro...	Nov 29,2004 06:31:48 PM			NmsLab II
Warning	172.16.33.4_DISC_SYSLOG	Unable to Setup Syslog on device - Device Erro...	Nov 29,2004 06:32:44 PM			NmsLab II
Warning	172.16.33.10_DISC_SYSL...	Unable to Setup Syslog on device - Device Erro...	Nov 29,2004 06:33:35 PM			NMS Lab II
Warning	172.16.33.12_DISC_SYSL...	Unable to Setup Syslog on device - Device Erro...	Nov 29,2004 06:33:54 PM			NMS Lab VII
Warning	172.16.33.31_DISC_SYSL...	Unable to Setup Syslog on device - Device Erro...	Nov 29,2004 06:38:32 PM			NMS Lab VII

FIGURE 13-1 Alarms Subview

The entire table can be exported to a file or only selected items in the list.

13.1.1 Exporting the Entire Table

13.1.1.1 All Subviews Except Performance Data

To export the entire table, select *Edit -> Export Table Data* from the Panel-Specific Menu Bar. The Export PhysicalLinks Data form, shown in the following figure, will appear.

FIGURE 13-2 Export Alarms Data Form - No Criteria Set

The Export Alarms Data form consists of a destination panel and a database match criteria panel. In the destination panel, you can select the destination for the exported data as either a file on the NMS server or your Web browser. In the Database Match Criteria panel, you can specify the match criteria, a qualifier, and a match string. The criteria correspond to fields in the data table, such as **Status**, **Owner**, **Alarm Message**, etc. The qualifiers are match specifications, such as equals to, not equals to, contains, etc. The match string field is where you type the string you want to match.

The radio buttons in the **Export Destination** panel allow you to specify the data destination. To send the data to your Web browser, click the **Browser (Client)** radio button. If you have more than one Web browser on your machine, select the desired browser.

To send the data to a file, do the following:

1. Click the **Text File (Server)** radio button
2. Click **File Chooser**. The **Open** form will appear.
3. In the **Open** form, double-click **state** in the directory view panel.

Note: You must store your file in the **state** directory. If you attempt to store your file in any other directory, you will get an error message.

4. Type the desired filename in the **File Name** field, and then click **Open**. The **Open** form will close, and the file you chose will appear in the **Text File (Server)** field of the **Export Alerts Data** form.
5. Select a data separator from the **Separator** drop-down list. If the desired separator is not in the list, select **other (specify)**, and then type the desired separator in the **Other** field.

Once you have specified the data destination, specify the match criteria in the **Database Match Criteria** panel as follows:

1. Select a criteria from the drop-down list, select a qualifier from the qualifier drop-down list, and then enter a match string in the match string field.
2. If you need more qualifiers, click **More**, and then enter the additional qualifier. Repeat as necessary.

Note: Click **Fewer** to remove the last qualifier that you added.

3. Click **OK** to export the data. A confirmation dialog box will appear indicating that the data export was successful. Click **OK** in the confirmation dialog box.

The following figure shows an example of how to export all major alarms on device to file **alarms_major** using the percent sign (%) as the data separator. The resulting data file is described in [13.1.3](#).

The screenshot shows a dialog box titled "Export Alerts Data". It is divided into two main sections: "Export Destination" and "Database Match Criteria".

Export Destination:

- Server File Name:** state\alarms_Major (with a "File Chooser" button to the right)
- Separator:** other (specify) (dropdown menu)
- Other:** % (text input field)
- Browser (Client):** Use default browser (text input field)

Database Match Criteria:

- Status:** Major (dropdown menu)
- Operator:** equals to (dropdown menu)
- Value:** Major (text input field)

At the bottom of the dialog box, there are buttons for "More", "Fewer", "OK", and "Cancel".

FIGURE 13-3 Export Major Alarms Data Example

13.1.1.2 Exporting Performance Data

Performance Data is different in that each statistic is counted against what is called an instance, or component. The following figure shows these instances when plotting a statistic for a device. The pull-down shows that the VLAN number IDs as well as the port numbers are instances statistics can be counted against.

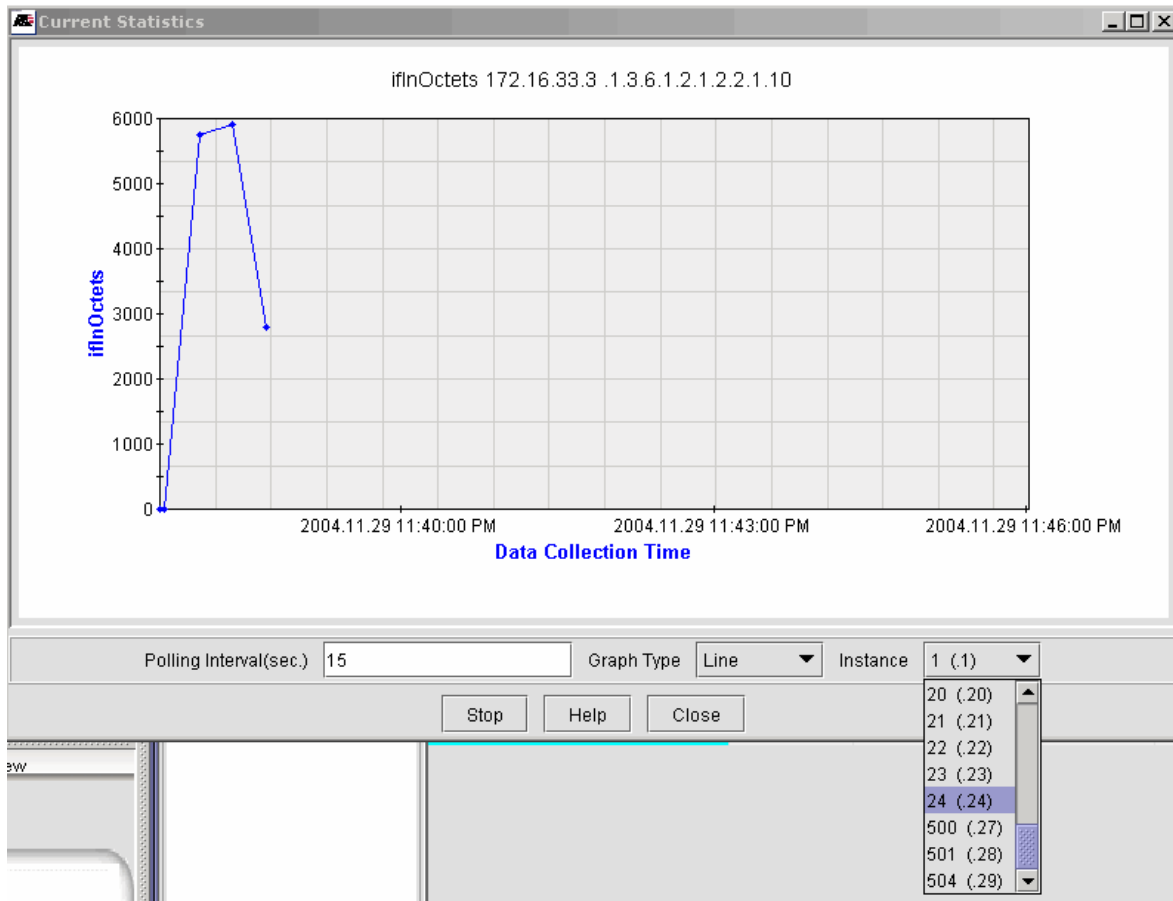

FIGURE 13-4 Viewing Instances in a Device for a Statistic

When exporting the statistical data in a table, the user can isolate this instance as part of the match criteria. The following figure shows setting up the instance criteria for the statistic and the results (in a web browser). Note that the time between each polled value is 15 seconds.

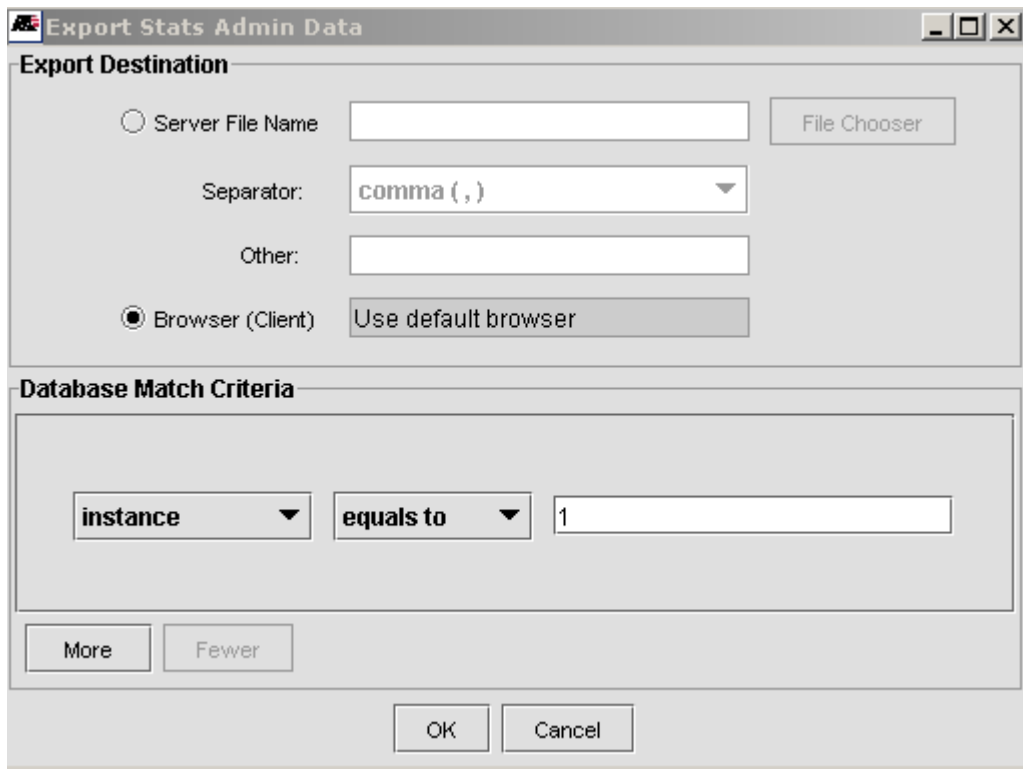

FIGURE 13-5 Setting the Criteria for Performance (Instance)

Stats Admin Exported Data - Mon Nov 29 23:49:38 EST 2004

value	agent	instance	time	oid
2699	172.16.33.3	1	Mon Nov 29 22:49:56 EST 2004	.1.3.6.1.2.1.2.2.1.10
2699	172.16.33.3	1	Mon Nov 29 22:50:11 EST 2004	.1.3.6.1.2.1.2.2.1.10
2874	172.16.33.3	1	Mon Nov 29 22:50:26 EST 2004	.1.3.6.1.2.1.2.2.1.10
3571	172.16.33.3	1	Mon Nov 29 22:50:41 EST 2004	.1.3.6.1.2.1.2.2.1.10
3356	172.16.33.3	1	Mon Nov 29 22:50:56 EST 2004	.1.3.6.1.2.1.2.2.1.10
2786	172.16.33.3	1	Mon Nov 29 22:51:11 EST 2004	.1.3.6.1.2.1.2.2.1.10
2850	172.16.33.3	1	Mon Nov 29 22:51:26 EST 2004	.1.3.6.1.2.1.2.2.1.10
2763	172.16.33.3	1	Mon Nov 29 22:51:41 EST 2004	.1.3.6.1.2.1.2.2.1.10

FIGURE 13-6 Results of Performance Statistic by Instance (15-second Intervals)

13.1.2 Exporting Selected Items

To export manually selected items from a data table, select the items you wish to export (use SHIFT+left-click to select multiple items), and then select *Edit -> Export Selected Rows* from the Panel-Specific Menu Bar. The Export Events Data form, shown in the following figure, will appear.

The image shows a dialog box titled "Export Alerts Data" with a "Save Destination" section. It contains two radio buttons: "Server File Name" and "Browser (Client)". The "Server File Name" option is selected. Next to it is a text input field and a "File Chooser" button. Below this is a "Separator:" dropdown menu with "space ()" selected. There is also an "Other:" text input field. The "Browser (Client)" option is unselected, with a text input field containing "Use default browser". At the bottom are "OK" and "Cancel" buttons.

FIGURE 13-7 Export PhysicalLinks Data Form - Exporting Selected Data

The **Database Match Criteria** panel does not appear on this form since the items were manually selected. On this form, select a target for the exported data as described in the previous paragraphs. The resulting data file is described in the following section.

13.1.3 Viewing a Data Export File

If you export table data to a file, you can access the file using your Web browser as follows:

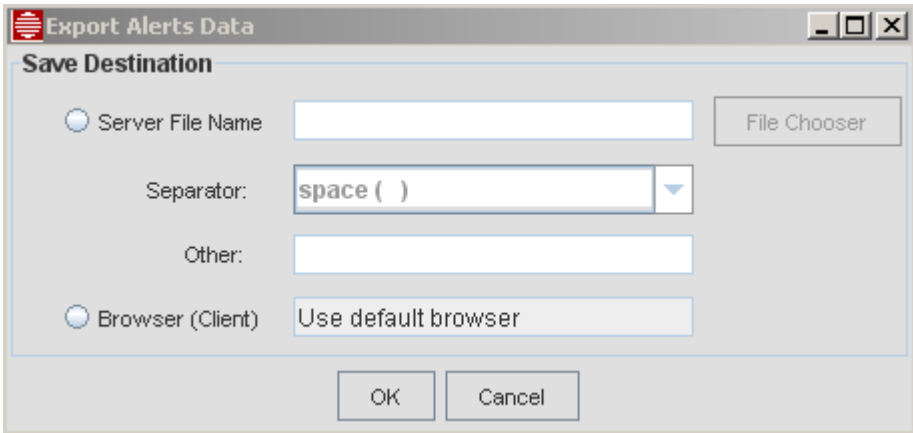
1. Enter the following address in your Web browser Address bar:
Input: `http://<NMS_server_ip>:9090/state`
where `NMS_server_ip` is the IP address of the NMS Server.
2. Locate your data file. For Microsoft Internet Explorer, right-click the file. For Netscape, **SHIFT**+right-click the file.
3. Save the file to a directory on your local machine.
4. To view the file, open it on your local machine with any ASCII text editor, such as Notepad or vi.

An example data file is shown in the following figure. This file is the result of the data export example described previously. Notice that each field in the table is separated with a semi-colon (;), which was defined as the separator in the example.

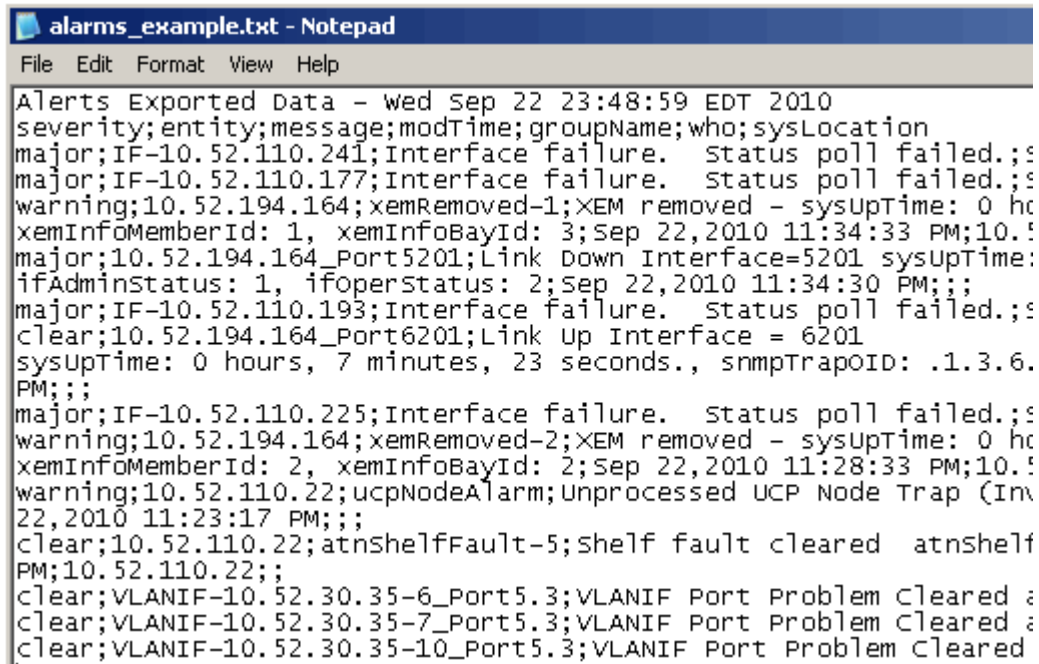

```
alarms_example.txt - Notepad
File Edit Format View Help
Alerts Exported Data - Wed Sep 22 23:48:59 EDT 2010
severity;entity;message;modTime;groupName;who;sysLocation
major;IF-10.52.110.241;Interface failure. Status poll failed.;s
major;IF-10.52.110.177;Interface failure. Status poll failed.;s
warning;10.52.194.164;xemRemoved-1;XEM removed - sysUpTime: 0 hc
xemInfoMemberId: 1, xemInfoBayId: 3;Sep 22,2010 11:34:33 PM;10.5
major;10.52.194.164_Port5201;Link Down Interface=5201 sysUpTime:
ifAdminStatus: 1, ifoperStatus: 2;Sep 22,2010 11:34:30 PM;;;
major;IF-10.52.110.193;Interface failure. Status poll failed.;s
clear;10.52.194.164_Port6201;Link Up Interface = 6201
sysUpTime: 0 hours, 7 minutes, 23 seconds., snmpTrapOID: .1.3.6.
PM;;;
major;IF-10.52.110.225;Interface failure. Status poll failed.;s
warning;10.52.194.164;xemRemoved-2;XEM removed - sysUpTime: 0 hc
xemInfoMemberId: 2, xemInfoBayId: 2;Sep 22,2010 11:28:33 PM;10.5
warning;10.52.110.22;ucpNodeAlarm;Unprocessed UCP Node Trap (Im
22,2010 11:23:17 PM;;;
clear;10.52.110.22;atnShelfFault-5;shelf fault cleared atnshelf
PM;10.52.110.22;;
clear;VLANIF-10.52.30.35-6_Port5.3;VLANIF Port Problem Cleared ;
clear;VLANIF-10.52.30.35-7_Port5.3;VLANIF Port Problem Cleared ;
clear;VLANIF-10.52.30.35-10_Port5.3;VLANIF Port Problem Cleared
```

FIGURE 13-8 Exported Data File Example- File

13.1.4 Viewing Data on a Web Browser

If you exported the data to your Web browser, the data will be displayed in a new browser window. An example is shown in the following figure. You can use the menus in your Web browser to view, print, or save the information.

Events Exported Data - Wed Sep 22 23:54:17 EDT 2010

severity	entity	text	time
major	IF-10.52.110.241	Interface failure. Status poll failed.	Sep 22,2010 11:39:36 PM
info	10.52.194.164;LLDPtablesChanged	LLDP tables changed -- sysUpTime: 0 hours, 7 minutes, 13 seconds., snmpTrapOID: .1.0.8802.1.1.2.0.0.1, lldpStatsRemTablesInserts: 2, lldpStatsRemTablesDeletes: 1, lldpStatsRemTablesDrops: 0, lldpStatsRemTablesAgeouts: 1	Sep 22,2010 11:36:18 PM
major	IF-10.52.110.177	Interface failure. Status poll failed.	Sep 22,2010 11:36:04 PM
clear	IF-10.52.110.241	Interface clear.	Sep 22,2010 11:34:34 PM

FIGURE 13-9 Tabular Data Displayed in a Web Browser

13.2 dhcpd Files

Following is a complete example of a dhcpd file, with comments highlighted. There are five files, since DHCP-related configurations for each Access Island are placed in separate configuration files.

13.2.1 dhcpd.conf

```
# dhcpd.conf for Service Provider Solutions Interop (SPSI) lab
# Jul-12-08 JWS: removed subnets AI01, L2Supp, YKTA
# Jul-8-10 JWS: added subnets spsi-ai00-awplus

log-facility local7;
#####
# In addition to setting this value, you may need to modify your
# syslog.conf file to configure logging of the DHCP server.
# For example, you might add a line like this:
# local7.*          /val/log/dhcpd.log
# local7.info      @10.52.110.4
#####
server-name "dhcp1";
server-identifier dhcp1.spsi.lab.telesyn.corp;
authoritative;
ddns-update-style interim;
#option domain-name-servers 166.163.129.19,166.163.128.15,166.163.128.5;
default-lease-time 86400;
max-lease-time 86400;
# To identify the network that this machine is physically on.
#subnet 10.52.110.32 netmask 255.255.255.240 {
#subnet 10.52.201.0 netmask 255.255.255.0 {
}

if exists agent.circuit-id
{
  if ((substring(option vendor-class-identifier,0,8)="iMG646PX") or (substring(option vendor-class-identifi-
er,0,9)="iMG646MOD"))
  {
    log (info, concat(
      " PX INCOMING> ",binary-to-ascii(10, 8, ".", leased-address),
      " MAC: ",binary-to-ascii(16,8,":",hardware),
      " offered to iMAP: ",(option agent.remote-id),
      " INTERFACE: ",binary-to-ascii(10, 8, ".", substring(option agent.circuit-id, 0, 3)),
      ", VLAN: ",binary-to-ascii(10, 16, "", substring(option agent.circuit-id, 3, 2))
    ));
  }
  else
  {
    log (info, concat(
      " INCOMING> ",binary-to-ascii(10, 8, ".", leased-address),
      " MAC: ",binary-to-ascii(16,8,":",hardware),
      " offered to iMAP: ",(option agent.remote-id),
      " INTERFACE: ",binary-to-ascii(10, 8, ".", substring(option agent.circuit-id, 0, 2)),
      ", VLAN: ",binary-to-ascii(10, 16, "", substring(option agent.circuit-id, 2, 2))
    ));
  }
}

#log ( info, concat(
#>>Lease for ",binary-to-ascii(10, 8, ".", leased-address),
#" raw option-82 info is CID: ",binary-to-ascii(10, 8, ".", option agent.circuit-id),
#" AID: ",binary-to-ascii(16, 8, ".", option agent.remote-id)
# ));

on commit
{
  if ((substring(option vendor-class-identifier,0,8)="iMG646PX") or (substring(option vendor-class-identifi-
er,0,9)="iMG646MOD"))
  {
    log (info, concat(
      " LEASE ACK>> ",binary-to-ascii(10, 8, ".", leased-address),
      " MAC: ",binary-to-ascii(16,8,":",hardware),
      " linked & associated to iMAP: ",(option agent.remote-id),
      " INTERFACE: ",binary-to-ascii(10, 8, ".", substring(option agent.circuit-id, 0, 3)),
      ", VLAN: ",binary-to-ascii(10, 16, "", substring(option agent.circuit-id, 3, 2))
    ));
  }
  else
  {
    log (info, concat(
      " LEASE ACK>> ",binary-to-ascii(10, 8, ".", leased-address),
      " MAC: ",binary-to-ascii(16,8,":",hardware),
      " linked & associated to iMAP: ",(option agent.remote-id),
      " INTERFACE: ",binary-to-ascii(10, 8, ".", substring(option agent.circuit-id, 0, 2)),
      ", VLAN: ",binary-to-ascii(10, 16, "", substring(option agent.circuit-id, 2, 2))
    ));
  }
}
```

```

}
}

on expiry
{
    if ((substring(option vendor-class-identifier,0,8)="img646PX" or (substring(option vendor-class-identifi-
er,0,9)="img646MOD"))
    {
        log (info, concat(
            " LEASE EXPIRE>> ",binary-to-ascii(10, 8, ".", leased-address),
            " MAC: ",binary-to-ascii(16,8,":",hardware),
            " associated to iMAP: ",(option agent.remote-id),
            " INTERFACE: ",binary-to-ascii(10, 8, ".", substring(option agent.circuit-id, 0, 2)),
            ", VLAN: ",binary-to-ascii(10, 16, "", substring(option agent.circuit-id, 2, 2))
        ));
    }
    else
    {
        log (info, concat(
            " LEASE EXPIRE>> ",binary-to-ascii(10, 8, ".", leased-address),
            " MAC: ",binary-to-ascii(16,8,":",hardware),
            " associated to iMAP: ",(option agent.remote-id),
            " INTERFACE: ",binary-to-ascii(10, 8, ".", substring(option agent.circuit-id, 0, 2)),
            ", VLAN: ",binary-to-ascii(10, 16, "", substring(option agent.circuit-id, 2, 2))
        ));
    }
}

on release
{
    if ((substring(option vendor-class-identifier,0,8)="img646PX" or (substring(option vendor-class-identifi-
er,0,9)="img646MOD"))
    {
        log (info, concat(
            " RELEASE> ",binary-to-ascii(10, 8, ".", leased-address),
            " MAC: ",binary-to-ascii(16,8,":",hardware),
            " released on iMAP: ",(option agent.remote-id),
            " INTERFACE: ",binary-to-ascii(10, 8, ".", substring(option agent.circuit-id, 0, 2)),
            " VLAN: ",binary-to-ascii(10, 16, "", substring(option agent.circuit-id, 2, 2))
        ));
    }
    else
    {
        log (info, concat(
            " RELEASE> ",binary-to-ascii(10, 8, ".", leased-address),
            " MAC: ",binary-to-ascii(16,8,":",hardware),
            " released on iMAP: ",(option agent.remote-id),
            " INTERFACE: ",binary-to-ascii(10, 8, ".", substring(option agent.circuit-id, 0, 2)),
            ", VLAN: ",binary-to-ascii(10, 16, "", substring(option agent.circuit-id, 2, 2))
        ));
    }
}

# STB class config files
include "/etc/dhcpd_include/vendor-amino.conf";
include "/etc/dhcpd_include/class-stb.conf";

# MAP class config files
include "/etc/dhcpd_include/spsi-ai00-class";
include "/etc/dhcpd_include/spsi-ai00-awplus-class";

# MAP subnet config files
include "/etc/dhcpd_include/spsi-ai00-subnet";
include "/etc/dhcpd_include/spsi-ai00-awplus-subnet";

```

13.2.2 dhcpcd Includes

13.2.2.1 spsi-ai00-class

```
# spsi-ai00-class for Service Provider Solutions Interop (SPSI) lab Access Island 0
# Jul-15-08 JWS: modified for migration of nms server ip from 10.52.110.4 to 10.52.201.4
# Jul-22-08 JWS: modified for iMG634A-R2 (ODM)
# Feb-12-09 JWS: modified to add iMG613RF, iMG616BD
# Feb-13-09 JWS: modified to add iMG606BD
# Mar-31-09 JWS: modified to add iMG726MOD, iMG746MOD
# Jul-22-09 JWS: modified to add iMG616W
# Oct-9-09 JWS: modified for iMG624A-R2
# Oct-22-09 JWS: modified for Comtrend NexusLink 5631 ADSL bonded CPE
# Dec-4-09 JWS: modified rg613tx boot path
# Feb-12-10 JWS: modified to completely add iMG634WA
# Jul-7-10 JWS: corrected boot file path for iMG7x6MOD
# Dec-14-10 JWS: modified to add video class for iMGs
# Apr-7-11 JWS: added iMG726BD-ON
# May-4-11 JWS: added iMG606BD-R2
# May-19-11 JWS: added iMG616BD-R2, removed img's that don't support voice from voice section, other clean up
# Jun-8-11 JWS: added iMG613RF voice
# Aug-1-11 JWS: added iMG2504
# Aug-4-11 JWS: added iMG1525
# Oct-6-11 JWS: added iMG1505
# Dec-2-11 JWS: added iMG2524, removed img1505 and img2504 from voice section

#####

# AGENT REMOTE ID:

# SPSI-AI00 (TEST [AI00] ACCESS ISLAND) #

# AGENT CIRCUIT ID:

# Vlan 100 (MAPMgmt) = \x00\x64 = 10.52.110.16 255.255.255.240 nonUFO
# Vlan 200 (RGBoot) = \x00\xc8 = 10.52.111.0 255.255.255.192 UFO
# Vlan 300 (RGMgmt) = \x01\x2c = 10.52.111.64 255.255.255.192 UFO
# Vlan 400 (Voice) = \x01\x90 = 10.52.111.128 255.255.255.192 UFO
# Vlan 500 (Video) = \x01\xf4 = 10.52.111.192 255.255.255.192 UFO
# Vlan 600 (Internet) = \x02\x58 = 10.52.110.64 255.255.252.224 UFO?

#####

### RG Mgmt vlan 300 ###

class "SPSI-AI00-RG613TXMgmt" {
    match if ((substring(option agent.remote-id,0,9)="SPSI-AI00") and (substring(option agent.circuit-id,2,2)="x01\x2c")
and
        (option vendor-class-identifier = "RG613TX"));
        option vendor-class-identifier "RG613TX";
}

class "SPSI-AI00-RG624AMgmt" {
    match if ((substring(option agent.remote-id,0,9)="SPSI-AI00") and (substring(option agent.circuit-id,2,2)="x01\x2c")
and
        (option vendor-class-identifier = "RG624A"));
        option vendor-class-identifier "RG624A";
}

class "SPSI-AI00-RG634AMgmt" {
    match if ((substring(option agent.remote-id,0,9)="SPSI-AI00") and (substring(option agent.circuit-id,2,2)="x01\x2c")
and
        (option vendor-class-identifier = "RG634A"));
        option vendor-class-identifier "RG634A";
}

class "SPSI-AI00-iMG606BDMgmt" {
    match if ((substring(option agent.remote-id,0,9)="SPSI-AI00") and (substring(option agent.circuit-id,2,2)="x01\x2c")
and
```

```

(option vendor-class-identifier = "iMG606BD");
    option vendor-class-identifier "iMG606BD";
}
class "SPSI-AI00-iMG606BD-R2Mgmt" {
    match if ((substring(option agent.remote-id,0,9)="SPSI-AI00") and (substring(option agent.circuit-id,2,2)="x01\x2c") and
        (option vendor-class-identifier = "iMG606BD-R2"));
    option vendor-class-identifier "iMG606BD-R2";
}
class "SPSI-AI00-iMG613RFMgmt" {
    match if ((substring(option agent.remote-id,0,9)="SPSI-AI00") and (substring(option agent.circuit-id,2,2)="x01\x2c") and
        (option vendor-class-identifier = "iMG613RF"));
    option vendor-class-identifier "iMG613RF";
}
class "SPSI-AI00-iMG616BDMgmt" {
    match if ((substring(option agent.remote-id,0,9)="SPSI-AI00") and (substring(option agent.circuit-id,2,2)="x01\x2c") and
        (option vendor-class-identifier = "iMG616BD"));
    option vendor-class-identifier "iMG616BD";
}
class "SPSI-AI00-iMG616BD-R2Mgmt" {
    match if ((substring(option agent.remote-id,0,9)="SPSI-AI00") and (substring(option agent.circuit-id,2,2)="x01\x2c") and
        (option vendor-class-identifier = "iMG616BD-R2"));
    option vendor-class-identifier "iMG616BD-R2";
}
class "SPSI-AI00-iMG616WMgmt" {
    match if ((substring(option agent.remote-id,0,9)="SPSI-AI00") and (substring(option agent.circuit-id,2,2)="x01\x2c") and
        (option vendor-class-identifier = "iMG616W"));
    option vendor-class-identifier "iMG616W";
}
class "SPSI-AI00-iMG624AMgmt" {
    match if ((substring(option agent.remote-id,0,9)="SPSI-AI00") and (substring(option agent.circuit-id,2,2)="x01\x2c") and
        (option vendor-class-identifier = "iMG624A"));
    option vendor-class-identifier "iMG624A";
}
class "SPSI-AI00-iMG624A-R2Mgmt" {
    match if ((substring(option agent.remote-id,0,9)="SPSI-AI00") and (substring(option agent.circuit-id,2,2)="x01\x2c") and
        (option vendor-class-identifier = "iMG624A-R2"));
    option vendor-class-identifier "iMG624A-R2";
}
class "SPSI-AI00-iMG634AMgmt" {
    match if ((substring(option agent.remote-id,0,9)="SPSI-AI00") and (substring(option agent.circuit-id,2,2)="x01\x2c") and
        (option vendor-class-identifier = "iMG634A"));
    option vendor-class-identifier "iMG634A";
}
class "SPSI-AI00-iMG634A-R2Mgmt" {
    match if ((substring(option agent.remote-id,0,9)="SPSI-AI00") and (substring(option agent.circuit-id,2,2)="x01\x2c") and
        (option vendor-class-identifier = "iMG634A-R2"));
}

```

```
    option vendor-class-identifier "iMG634A-R2";
}
class "SPSI-AI00-iMG634WAMgmt" {
    match if ((substring(option agent.remote-id,0,9)="SPSI-AI00") and (substring(option agent.circuit-id,2,2)="x01x2c")
and
    (option vendor-class-identifier = "iMG634WA"));
    option vendor-class-identifier "iMG634WA";
}
class "SPSI-AI00-iMG646BDMgmt" {
    match if ((substring(option agent.remote-id,0,9)="SPSI-AI00") and (substring(option agent.circuit-id,2,2)="x01x2c")
and
    (option vendor-class-identifier = "iMG646BD"));
    option vendor-class-identifier "iMG646BD";
}
class "SPSI-AI00-iMG646BD-ONMgmt" {
    match if ((substring(option agent.remote-id,0,9)="SPSI-AI00") and (substring(option agent.circuit-id,2,2)="x01x2c")
and
    (option vendor-class-identifier = "iMG646BD-ON"));
    option vendor-class-identifier "iMG646BD-ON";
}
class "SPSI-AI00-iMG626MODMgmt" {
    match if ((substring(option agent.remote-id,0,9)="SPSI-AI00") and
((substring(option agent.circuit-id,2,2)="x01x2c") or (substring(option agent.circuit-id,3,2)="x01x2c")) and
    (option vendor-class-identifier = "iMG626MOD"));
    option vendor-class-identifier "iMG626MOD";
}
class "SPSI-AI00-iMG646MODMgmt" {
    match if ((substring(option agent.remote-id,0,9)="SPSI-AI00") and
((substring(option agent.circuit-id,2,2)="x01x2c") or (substring(option agent.circuit-id,3,2)="x01x2c")) and
    (option vendor-class-identifier = "iMG646MOD"));
    option vendor-class-identifier "iMG646MOD";
}
class "SPSI-AI00-iMG646PX-ONMgmt" {
    match if ((substring(option agent.remote-id,0,9)="SPSI-AI00") and (substring(option agent.circuit-id,3,2)="x01x2c")
and
    (option vendor-class-identifier = "iMG646PX-ON"));
    option vendor-class-identifier "iMG646PX-ON";
}
class "SPSI-AI00-iMG726BD-ONMgmt" {
    match if ((substring(option agent.remote-id,0,9)="SPSI-AI00") and (substring(option agent.circuit-id,2,2)="x01x2c")
and
    (option vendor-class-identifier = "iMG726BD-ON"));
    option vendor-class-identifier "iMG726BD-ON";
}
class "SPSI-AI00-iMG726MODMgmt" {
    match if ((substring(option agent.remote-id,0,9)="SPSI-AI00") and
((substring(option agent.circuit-id,2,2)="x01x2c") or (substring(option agent.circuit-id,3,2)="x01x2c")) and
    (option vendor-class-identifier = "iMG726MOD"));
    option vendor-class-identifier "iMG726MOD";
}
```

```

}
class "SPSI-AI00-IMG746MODMgmt" {
    match if ((substring(option agent.remote-id,0,9)="SPSI-AI00") and
              ((substring(option agent.circuit-id,2,2)="x01\x2c") or (substring(option agent.circuit-id,3,2)="x01\x2c"))) and
              (option vendor-class-identifier = "IMG746MOD"));
    option vendor-class-identifier "IMG746MOD";
}
class "SPSI-AI00-iBG915FXMgmt" {
    match if ((substring(option agent.remote-id,0,9)="SPSI-AI00") and (substring(option agent.circuit-id,2,2)="x01\x2c") and
              (option vendor-class-identifier = "iBG915FX"));
    option vendor-class-identifier "iBG915FX";
}
class "SPSI-AI00-IMG1505Mgmt" {
    match if ((substring(option agent.remote-id,0,9)="SPSI-AI00") and (substring(option agent.circuit-id,2,2)="x01\x2c") and
              (option vendor-class-identifier = "IMG1505"));
    option vendor-class-identifier "IMG1505";
}
class "SPSI-AI00-IMG1525Mgmt" {
    match if ((substring(option agent.remote-id,0,9)="SPSI-AI00") and (substring(option agent.circuit-id,2,2)="x01\x2c") and
              (option vendor-class-identifier = "IMG1525"));
    option vendor-class-identifier "IMG1525";
}
class "SPSI-AI00-IMG2504Mgmt" {
    match if ((substring(option agent.remote-id,0,9)="SPSI-AI00") and (substring(option agent.circuit-id,2,2)="x01\x2c") and
              (option vendor-class-identifier = "IMG2504"));
    option vendor-class-identifier "IMG2504";
}
class "SPSI-AI00-IMG2524Mgmt" {
    match if ((substring(option agent.remote-id,0,9)="SPSI-AI00") and (substring(option agent.circuit-id,2,2)="x01\x2c") and
              (option vendor-class-identifier = "IMG2524"));
    option vendor-class-identifier "IMG2524";
}
class "SPSI-AI00-ComtrendMgmt"
{
    match if
        (substring
         (option agent.remote-id,0,9)
         ="SPSI-AI00")
        and
        (substring
         (option agent.circuit-id,2,2)
         ="x01\x2c")
        and
        (substring
         (option vendor-class-identifier,0,5)
         ="uDHCP")
    ;
# option bootfile-name "10.52.201.4";
}

### RG Boot vlan 200 ###
class "SPSI-AI00-RG613TXBoot" {
    match if ((substring(option agent.remote-id,0,9)="SPSI-AI00") and (substring(option agent.circuit-id,2,2)="x00\xc8") and
              (option vendor-class-identifier = "RG613TX"));
    filename "FIBER/AI00/RG613TX";
}

```



```
    option tftp-server-name "10.52.201.4";
    option vendor-class-identifier "RG613TX";
}
class "SPSI-AI00-RG624ABoot" {
    match if ((substring(option agent.remote-id,0,9)="SPSI-AI00") and (substring(option agent.circuit-id,2,2)="x00\xc8")
and
    (option vendor-class-identifier = "RG624A"));
    filename "ADSL/AI00/RG600A";
    option tftp-server-name "10.52.201.4";
    option vendor-class-identifier "RG624A";
}
class "SPSI-AI00-RG634ABoot" {
    match if ((substring(option agent.remote-id,0,9)="SPSI-AI00") and (substring(option agent.circuit-id,2,2)="x00\xc8")
and
    (option vendor-class-identifier = "RG634A"));
    filename "ADSL/AI00/RG600A";
    option tftp-server-name "10.52.201.4";
    option vendor-class-identifier "RG634A";
}
class "SPSI-AI00-IMG606BDBoot" {
    match if ((substring(option agent.remote-id,0,9)="SPSI-AI00") and (substring(option agent.circuit-id,2,2)="x00\xc8")
and
    (option vendor-class-identifier = "IMG606BD"));
    filename "FIBER/AI00/IMG6XX";
    option tftp-server-name "10.52.201.4";
    option vendor-class-identifier "IMG606BD";
}
class "SPSI-AI00-IMG606BD-R2Boot" {
    match if ((substring(option agent.remote-id,0,9)="SPSI-AI00") and (substring(option agent.circuit-id,2,2)="x00\xc8")
and
    (option vendor-class-identifier = "IMG606BD-R2"));
    filename "FIBER/AI00/IMG606BD-R2";
    option tftp-server-name "10.52.201.4";
    option vendor-class-identifier "IMG606BD-R2";
}
class "SPSI-AI00-IMG613RFBoot" {
    match if ((substring(option agent.remote-id,0,9)="SPSI-AI00") and (substring(option agent.circuit-id,2,2)="x00\xc8")
and
    (option vendor-class-identifier = "IMG613RF"));
    filename "FIBER/AI00/IMG600";
    option tftp-server-name "10.52.201.4";
    option vendor-class-identifier "IMG613RF";
}
class "SPSI-AI00-IMG616BDBoot" {
    match if ((substring(option agent.remote-id,0,9)="SPSI-AI00") and (substring(option agent.circuit-id,2,2)="x00\xc8")
and
    (option vendor-class-identifier = "IMG616BD"));
    filename "FIBER/AI00/IMG616";
```

```
option tftp-server-name "10.52.201.4";
option vendor-class-identifier "img616BD";
}
class "SPSI-AI00-img616BD-R2Boot" {
    match if ((substring(option agent.remote-id,0,9)="SPSI-AI00") and (substring(option agent.circuit-id,2,2)="x00\xc8") and
        (option vendor-class-identifier = "img616BD-R2"));
        filename "FIBER/AI00/IMG616BD-R2";
        option tftp-server-name "10.52.201.4";
        option vendor-class-identifier "img616BD-R2";
}
class "SPSI-AI00-img616WBoot" {
    match if ((substring(option agent.remote-id,0,9)="SPSI-AI00") and (substring(option agent.circuit-id,2,2)="x00\xc8") and
        (option vendor-class-identifier = "img616W"));
        filename "FIBER/AI00/IMG616W";
        option tftp-server-name "10.52.201.4";
        option vendor-class-identifier "img616W";
}
class "SPSI-AI00-img624ABoot" {
    match if ((substring(option agent.remote-id,0,9)="SPSI-AI00") and (substring(option agent.circuit-id,2,2)="x00\xc8") and
        (option vendor-class-identifier = "img624A"));
        filename "ADSL/AI00/IMG624A";
        option tftp-server-name "10.52.201.4";
        option vendor-class-identifier "img624A";
}
class "SPSI-AI00-img624A-R2Boot" {
    match if ((substring(option agent.remote-id,0,9)="SPSI-AI00") and (substring(option agent.circuit-id,2,2)="x00\xc8") and
        (option vendor-class-identifier = "img624A-R2"));
        filename "ADSL/AI00/IMG624A-R2";
        option tftp-server-name "10.52.201.4";
        option vendor-class-identifier "img624A-R2";
}
class "SPSI-AI00-img634ABoot" {
    match if ((substring(option agent.remote-id,0,9)="SPSI-AI00") and (substring(option agent.circuit-id,2,2)="x00\xc8") and
        (option vendor-class-identifier = "img634A"));
        filename "ADSL/AI00/IMG634A";
        option tftp-server-name "10.52.201.4";
        option vendor-class-identifier "img634A";
}
class "SPSI-AI00-img634A-R2Boot" {
    match if ((substring(option agent.remote-id,0,9)="SPSI-AI00") and (substring(option agent.circuit-id,2,2)="x00\xc8") and
        (option vendor-class-identifier = "img634A-R2"));
        filename "ADSL/AI00/IMG634A-R2";
        option tftp-server-name "10.52.201.4";
        option vendor-class-identifier "img634A-R2";
}
class "SPSI-AI00-img634WABoot" {
```

```

match if ((substring(option agent.remote-id,0,9)="SPSI-AI00") and (substring(option agent.circuit-id,2,2)="\x00\xc8")
and
(option vendor-class-identifier = "img634WA"));
filename "ADSL/AI00/IMG634WA";
option tftp-server-name "10.52.201.4";
option vendor-class-identifier "img634WA";
}
class "SPSI-AI00-img646BDBoot" {
match if ((substring(option agent.remote-id,0,9)="SPSI-AI00") and (substring(option agent.circuit-id,2,2)="\x00\xc8")
and
(option vendor-class-identifier = "img646BD"));
filename "FIBER/AI00/IMG6XX";
option tftp-server-name "10.52.201.4";
option vendor-class-identifier "img646BD";
}
class "SPSI-AI00-img646BD-ONBoot" {
match if ((substring(option agent.remote-id,0,9)="SPSI-AI00") and (substring(option agent.circuit-id,2,2)="\x00\xc8")
and
(option vendor-class-identifier = "img646BD-ON"));
filename "FIBER/AI00/IMG6XX";
option tftp-server-name "10.52.201.4";
option vendor-class-identifier "img646BD-ON";
}
class "SPSI-AI00-img626MODBoot" {
match if ((substring(option agent.remote-id,0,9)="SPSI-AI00") and
((substring(option agent.circuit-id,2,2)="\x00\xc8") or (substring(option agent.circuit-id,3,2)="\x00\xc8"))) and
(option vendor-class-identifier = "img626MOD"));
filename "FIBER/AI00/IMG626MOD";
option tftp-server-name "10.52.201.4";
option vendor-class-identifier "img626MOD";
}
class "SPSI-AI00-img646MODBoot" {
match if ((substring(option agent.remote-id,0,9)="SPSI-AI00") and
((substring(option agent.circuit-id,2,2)="\x00\xc8") or (substring(option agent.circuit-id,3,2)="\x00\xc8"))) and
(option vendor-class-identifier = "img646MOD"));
filename "FIBER/AI00/IMG646MOD";
option tftp-server-name "10.52.201.4";
option vendor-class-identifier "img646MOD";
}
class "SPSI-AI00-img646PX-ONBoot" {
match if ((substring(option agent.remote-id,0,9)="SPSI-AI00") and (substring(option agent.circuit-id,3,2)="\x00\xc8")
and
(option vendor-class-identifier = "img646PX-ON"));
filename "FIBER/AI00/IMG6XX";
option tftp-server-name "10.52.201.4";
option vendor-class-identifier "img646PX-ON";
}
class "SPSI-AI00-img726BD-ONBoot" {

```

```

match if ((substring(option agent.remote-id,0,9)="SPSI-AI00") and (substring(option agent.circuit-id,2,2)="x00\xc8") and
(option vendor-class-identifier = "img726BD-ON"));
    filename "FIBER/AI00/IMG726BD-ON";
    option tftp-server-name "10.52.201.4";
    option vendor-class-identifier "img726BD-ON";
}
class "SPSI-AI00-img726MODBoot" {
    match if ((substring(option agent.remote-id,0,9)="SPSI-AI00") and
((substring(option agent.circuit-id,2,2)="x00\xc8") or (substring(option agent.circuit-id,3,2)="x00\xc8")) and
(option vendor-class-identifier = "img726MOD"));
        filename "FIBER/AI00/IMG726MOD";
        option tftp-server-name "10.52.201.4";
        option vendor-class-identifier "img726MOD";
}
class "SPSI-AI00-img746MODBoot" {
    match if ((substring(option agent.remote-id,0,9)="SPSI-AI00") and
((substring(option agent.circuit-id,2,2)="x00\xc8") or (substring(option agent.circuit-id,3,2)="x00\xc8")) and
(option vendor-class-identifier = "img746MOD"));
        filename "FIBER/AI00/IMG746MOD";
        option tftp-server-name "10.52.201.4";
        option vendor-class-identifier "img746MOD";
}
class "SPSI-AI00-iBG915FXBoot" {
    match if ((substring(option agent.remote-id,0,9)="SPSI-AI00") and (substring(option agent.circuit-id,2,2)="x00\xc8") and
(option vendor-class-identifier = "iBG915FX"));
        filename "FIBER/AI00/IBG915FX";
        option tftp-server-name "10.52.201.4";
        option vendor-class-identifier "iBG915FX";
}
class "SPSI-AI00-IMG1505Boot" {
    match if ((substring(option agent.remote-id,0,9)="SPSI-AI00") and (substring(option agent.circuit-id,2,2)="x00\xc8") and
(option vendor-class-identifier = "img1505"));
        filename "FIBER/AI00/IMG1505";
        option tftp-server-name "10.52.201.4";
        option vendor-class-identifier "img1505";
}
class "SPSI-AI00-IMG1525Boot" {
    match if ((substring(option agent.remote-id,0,9)="SPSI-AI00") and (substring(option agent.circuit-id,2,2)="x00\xc8") and
(option vendor-class-identifier = "img1525"));
        filename "FIBER/AI00/IMG1525";
        option tftp-server-name "10.52.201.4";
        option vendor-class-identifier "img1525";
}
class "SPSI-AI00-IMG2504Boot" {
    match if ((substring(option agent.remote-id,0,9)="SPSI-AI00") and (substring(option agent.circuit-id,2,2)="x00\xc8") and
(option vendor-class-identifier = "img2504"));
        filename "FIBER/AI00/IMG2504";

```

```

    option tftp-server-name "10.52.201.4";
    option vendor-class-identifier "iMG2504";
}
class "SPSI-AI00-iMG2524Boot" {
  match if ((substring(option agent.remote-id,0,9)="SPSI-AI00") and (substring(option agent.circuit-id,2,2)="\x00\xc8")
and
  (option vendor-class-identifier = "iMG2524"));
  filename "FIBER/AI00/iMG2524";
  option tftp-server-name "10.52.201.4";
  option vendor-class-identifier "iMG2524";
}
### RG VoIP vlan 400 ###
class "SPSI-AI00-VoIP" {
  match if (
    (
      (substring (option agent.remote-id,0,9)="SPSI-AI00") and
      (substring (option agent.circuit-id,2,2)="\x01\x90") and
      (substring(option vendor-class-identifier,0,8)="iMG646BD")
    )
    or
    (
      (substring (option agent.remote-id,0,9)="SPSI-AI00") and
      (substring (option agent.circuit-id,2,2)="\x01\x90") and
      (substring(option vendor-class-identifier,0,2)="RG")
    )
    or
    (
      (substring (option agent.remote-id,0,9)="SPSI-AI00") and
      (substring (option agent.circuit-id,2,2)="\x01\x90") and
      (substring(option vendor-class-identifier,0,8)="iMG613RF")
    )
    or
    (
      (substring (option agent.remote-id,0,9)="SPSI-AI00") and
      (substring (option agent.circuit-id,2,2)="\x01\x90") and
      (substring(option vendor-class-identifier,0,8)="iMG616BD")
    )
    or
    (
      (substring (option agent.remote-id,0,9)="SPSI-AI00") and
      (substring (option agent.circuit-id,2,2)="\x01\x90") and
      (substring(option vendor-class-identifier,0,11)="iMG616BD-R2")
    )
    or
    (
      (substring (option agent.remote-id,0,9)="SPSI-AI00") and

```

```

    (substring (option agent.circuit-id,2,2)="x01\x90") and
    (substring(option vendor-class-identifier,0,8)="img616W")
)
or
(
    (substring (option agent.remote-id,0,9)="SPSI-AI00") and
    (substring (option agent.circuit-id,2,2)="x01\x90") and
    (substring(option vendor-class-identifier,0,7)="img634A")
)
or
(
    (substring (option agent.remote-id,0,9)="SPSI-AI00") and
    (substring (option agent.circuit-id,2,2)="x01\x90") and
    (substring(option vendor-class-identifier,0,8)="img634WA")
)
or
(
    (substring (option agent.remote-id,0,9)="SPSI-AI00") and
    (substring (option agent.circuit-id,3,2)="x01\x90") and
    (substring(option vendor-class-identifier,0,8)="img646PX")
)
or
(
    (substring (option agent.remote-id,0,9)="SPSI-AI00") and
    ((substring (option agent.circuit-id,2,2)="x01\x90") or (substring (option agent.circuit-id,3,2)="x01\x90")) and
    (substring(option vendor-class-identifier,0,9)="img626MOD")
)
or
(
    (substring (option agent.remote-id,0,9)="SPSI-AI00") and
    ((substring (option agent.circuit-id,2,2)="x01\x90") or (substring (option agent.circuit-id,3,2)="x01\x90")) and
    (substring(option vendor-class-identifier,0,9)="img646MOD")
)
or
(
    (substring (option agent.remote-id,0,9)="SPSI-AI00") and
    (substring (option agent.circuit-id,2,2)="x01\x90") and
    (substring(option vendor-class-identifier,0,11)="img726BD-ON")
)
or
(
    (substring (option agent.remote-id,0,9)="SPSI-AI00") and
    ((substring (option agent.circuit-id,2,2)="x01\x90") or (substring (option agent.circuit-id,3,2)="x01\x90")) and
    (substring(option vendor-class-identifier,0,9)="img726MOD")
)
or

```

```
(
  (substring (option agent.remote-id,0,9)="SPSI-AI00") and
  ((substring (option agent.circuit-id,2,2)="x01x90") or (substring (option agent.circuit-id,3,2)="x01x90")) and
  (substring(option vendor-class-identifier,0,9)="iMG746MOD")
)
or
(
  (substring (option agent.remote-id,0,9)="SPSI-AI00") and
  (substring (option agent.circuit-id,2,2)="x01x90") and
  (substring(option vendor-class-identifier,0,8)="iBG915FX")
)
or
(
  (substring (option agent.remote-id,0,9)="SPSI-AI00") and
  (substring (option agent.circuit-id,2,2)="x01x90") and
  (substring(option vendor-class-identifier,0,7)="iMG1525")
)
or
(
  (substring (option agent.remote-id,0,9)="SPSI-AI00") and
  (substring (option agent.circuit-id,2,2)="x01x90") and
  (substring(option vendor-class-identifier,0,7)="iMG2524")
)
);
}
### RG Video vlan 500 ###
class "SPSI-AI00-Video" {
  match if (
    (
      (substring (option agent.remote-id,0,9)="SPSI-AI00") and
      (substring (option agent.circuit-id,2,2)="x01xf4") and
      (
        (substring(option vendor-class-identifier,0,11)="iMG606BD-R2") or
        (substring(option vendor-class-identifier,0,11)="iMG616BD-R2") or
        (substring(option vendor-class-identifier,0,11)="iMG726BD-ON") or
        (substring(option vendor-class-identifier,0,7)="iMG1505") or
        (substring(option vendor-class-identifier,0,7)="iMG1525") or
        (substring(option vendor-class-identifier,0,7)="iMG2504") or
        (substring(option vendor-class-identifier,0,7)="iMG2524")
      )
    )
    or
    (
      (substring (option agent.remote-id,0,9)="SPSI-AI00") and
      ((substring (option agent.circuit-id,2,2)="x01xf4") or (substring (option agent.circuit-id,3,2)="x01xf4")) and
      (
        (substring(option vendor-class-identifier,0,9)="iMG726MOD") or
        (substring(option vendor-class-identifier,0,9)="iMG746MOD")
      )
    )
  );
}

### Internet vlan 600 ###
class "SPSI-AI00-Internet" {
```

```
match if (
  (
    (substring(option agent.remote-id,0,9)="SPSI-AI00") and
    (substring(option agent.circuit-id,2,2)="x02x58")
  )
  or
  (
    (substring(option agent.remote-id,0,9)="SPSI-AI00") and
    (substring(option agent.circuit-id,3,2)="x02x58")
  )
);

  set circuit-id = concat(option agent.circuit-id,"@",option agent.remote-id);
  spawn with pick(option agent.circuit-id, circuit-id);
  lease limit 5;
  log(info,concat(" EQUIP> ",option vendor-class-identifier, " is being used on Internet"));
}
```

13.2.2.2 spsi-ai00-awplus-class

```
# spsi-ai00-awplus-class for Service Provider Solutions Interop (SPSI) lab Access Island 0,
# AlliedWare Plus access ports for provisioning 3play iMGs
# Jul-7-10 JWS: copied from spsi-ai00-class, modified for AW+
# Jul-23-10 JWS: changed for aw+ dhcp snooping
# Apr-3-12 JWS: added img1505

#####

# AGENT REMOTE ID:

# None, since not supported by AW+ 5.3.3-0.4

# AGENT CIRCUIT ID:

# Vlan 201 (RGBoot)      = vlan201      = 10.52.110.176    255.255.255.240
# Vlan 301 (RGMgmt)     = vlan301     = 10.52.110.192    255.255.255.240
# Vlan 401 (Voice)      = vlan401     = 10.52.110.208    255.255.255.240
# Vlan 501 (Video)      = vlan501     = 10.52.110.224    255.255.255.240
# Vlan 601 (Internet)   = vlan601     = 10.52.110.240    255.255.252.240

#####

### RG Boot vlan 201 ###

class "SPSI-AI00-AWPLUS-IMG646MODBoot" {
    match if ((option agent.circuit-id="vlan201") or (substring(option agent.circuit-id,2,2)="x00\xc9"))
    and (option vendor-class-identifier = "iMG646MOD");
    filename "FIBER/AWPLUS/IMG646MOD";
    option tftp-server-name "10.52.201.4";
    option vendor-class-identifier "iMG646MOD";
}

class "SPSI-AI00-AWPLUS-IMG746MODBoot" {
    match if (option agent.circuit-id="vlan201") and (option vendor-class-identifier = "iMG746MOD");
    filename "FIBER/AWPLUS/IMG746MOD";
    option tftp-server-name "10.52.201.4";
    option vendor-class-identifier "iMG746MOD";
}

class "SPSI-AI00-AWPLUS-IMG1505Boot" {
    match if (option agent.circuit-id="vlan201") and (option vendor-class-identifier = "iMG1505");
    filename "FIBER/AWPLUS/IMG1505";
    option tftp-server-name "10.52.201.4";
    option vendor-class-identifier "iMG1505";
}

### RG Mgmt vlan 301 ###

class "SPSI-AI00-AWPLUS-IMG646MODMgmt" {
    match if ((option agent.circuit-id="vlan301") or (substring(option agent.circuit-id,2,2)="x01\x2d"))
    and (option vendor-class-identifier = "iMG646MOD");
    option vendor-class-identifier "iMG646MOD";
    # For TFTP discovery method
    # option bootfile-name "10.52.201.4";
}

class "SPSI-AI00-AWPLUS-IMG746MODMgmt" {
    match if (option agent.circuit-id="vlan301") and (option vendor-class-identifier = "iMG746MOD");
    option vendor-class-identifier "iMG746MOD";
}

class "SPSI-AI00-AWPLUS-IMG1505Mgmt" {
    match if (option agent.circuit-id="vlan301") and (option vendor-class-identifier = "iMG1505");
    option vendor-class-identifier "iMG1505";
}

### RG VoIP vlan 401 ###

class "SPSI-AI00-AWPLUS-VoIP" {
    match if ((option agent.circuit-id="vlan401") or (substring(option agent.circuit-id,2,2)="x01\x91"))
    and ((option vendor-class-identifier = "iMG646MOD")
    or (option vendor-class-identifier = "iMG746MOD"));
}

### Internet vlan 601 ###

class "SPSI-AI00-AWPLUS-Internet" {
    match if ((option agent.circuit-id="vlan601") or (substring(option agent.circuit-id,2,2)="x02\x59"));
}

#####
```

13.2.2.3 spsi-ai00-subnet

```
# spsi-ai00-subnet for Service Provider Solutions Interop (SPSI) lab Access Island 0
# Jul-15-08 JWS: modified for migration of nms server ip from 10.52.110.4 to 10.52.201.4
# Aug-11-08 JWS: modified for migration of dns domain from stelar.net to spsi.lab.telesyn.corp
# Feb-12-09 JWS: modified to add IMG613RF, IMG616BD
# Feb-13-09 JWS: modified to add IMG606BD
# Mar-31-09 JWS: modified to add IMG726MOD, IMG746MOD
# Jul-22-09 JWS: modified to add IMG616W
# Aug-7-09 JWS: modified to add domain server option in inet pool
# Oct-9-09 JWS: modified for IMG624A-R2
# Oct-22-09 JWS: modified for Comtrend NexusLink 5631 ADSL bonded CPE
# Feb-12-10 JWS: modified to completely add IMG634WA
# Sep-14-10 JWS: added dns options to rgboot, rgmgmt
# Apr-7-11 JWS: added IMG726BD-ON
# May-4-11 JWS: added IMG606BD-R2
# May-19-11 JWS: added IMG616BD-R2
# Aug-1-11 JWS: added IMG2504
# Aug-4-11 JWS: added IMG1525
# Oct-6-11 JWS: added IMG1505
# Dec-2-11 JWS: added IMG2524
```

#####

```
# AGENT REMOTE ID:
# SPSI-AI00 (TEST [AI00] ACCESS ISLAND) #
# AGENT CIRCUIT ID:
# Vlan 100 (MAPMgmt) = \x00\x64 = 10.52.110.16 255.255.255.240 nonUFO
# Vlan 200 (RGBoot) = \x00\xc8 = 10.52.111.0 255.255.255.192 UFO
# Vlan 300 (RGMgmt) = \x01\x2c = 10.52.111.64 255.255.255.192 UFO
# Vlan 400 (Voice) = \x01\x90 = 10.52.111.128 255.255.255.192 UFO
# Vlan 500 (Video) = \x01\xf4 = 10.52.111.192 255.255.255.192 UFO
# Vlan 600 (Internet) = \x02\x58 = 10.52.110.64 255.255.252.224 UFO?
```

#####

```
shared-network SPSI-AI00 {
    # MAPMgmt vlan subnet (/28 = 27 MAP devices)
    subnet 10.52.110.16 netmask 255.255.255.240 {
    }

    # RG/IMG voice vlan subnet (/26 = ~60 subscriber voice RG/IMG devices)
    subnet 10.52.111.128 netmask 255.255.255.192 {
        authoritative;
        ddns-updates on;
        ddns-update-style interim;
        ddns-domainname "rgvoip.spsi.lab.telesyn.corp";
        allow client-updates;
    }

    # start change JWS 2-Oct-07
    # Changed ddns-ttl from 24h to 5m to workaroud failure to ping new rgvoip ddns name
    # after failed nms provisioning of img.
    # ddns-ttl 86400;
    # ddns-ttl 300;

    ddns-rev-domainname "in-addr.arpa.";
    include "/etc/rndc.key";
    zone rgvoip.spsi.lab.telesyn.corp. {
        primary 10.52.201.36;
        key rndckey;
    }
    zone 111.52.10.in-addr.arpa. {
        primary 10.52.201.36;
    }
}
```

```
    key rndokey;
}
pool {
    authoritative;
    range 10.52.111.132 10.52.111.190;
#    default-lease-time 86400;
    default-lease-time 300;
#    max-lease-time 86400;
    max-lease-time 300;

    option routers 10.52.111.129;
    option subnet-mask 255.255.255.192;
    option broadcast-address 10.52.111.191;
    option domain-name "rgvoip.spsi.lab.telesyn.corp";
    option domain-name-servers 10.52.201.36;
    option host-name = concat ("rgvoip-",(binary-to-ascii(16,8,"-",substring(hardware,1,6))));
    ddns-hostname = concat ("rgvoip-",(binary-to-ascii(16,8,"-",substring(hardware,1,6))));
    allow members of "SPSI-AI00-VoIP";
}
}

# RG/iMG bootstrap vlan subnet
subnet 10.52.111.0 netmask 255.255.255.192 {
    pool {
        authoritative;
        range 10.52.111.4 10.52.111.62;
        default-lease-time 600;
        max-lease-time 600;
        option routers 10.52.111.1;
        option subnet-mask 255.255.255.192;
        option broadcast-address 10.52.111.63;
        option domain-name "spssi.lab.telesyn.corp";
        option domain-name-servers 10.52.201.36;
        allow members of "SPSI-AI00-iBG915FXBoot";
        allow members of "SPSI-AI00-iMG613RFBBoot";
        allow members of "SPSI-AI00-iMG606BDBBoot";
        allow members of "SPSI-AI00-iMG606BD-R2Boot";
        allow members of "SPSI-AI00-iMG616BDBBoot";
        allow members of "SPSI-AI00-iMG616BD-R2Boot";
        allow members of "SPSI-AI00-iMG616WBoot";
        allow members of "SPSI-AI00-iMG646BDBBoot";
        allow members of "SPSI-AI00-iMG646BD-ONBoot";
        allow members of "SPSI-AI00-iMG646PX-ONBoot";
        allow members of "SPSI-AI00-iMG626MODBoot";
        allow members of "SPSI-AI00-iMG646MODBoot";
        allow members of "SPSI-AI00-iMG726BD-ONBoot";
        allow members of "SPSI-AI00-iMG726MODBoot";
    }
}
```

```
allow members of "SPSI-AI00-iMG746MODBoot";
allow members of "SPSI-AI00-iMG1505Boot";
allow members of "SPSI-AI00-iMG1525Boot";
allow members of "SPSI-AI00-iMG2504Boot";
allow members of "SPSI-AI00-iMG2524Boot";
allow members of "SPSI-AI00-iMG634WABoot";
allow members of "SPSI-AI00-iMG624ABoot";
allow members of "SPSI-AI00-iMG624A-R2Boot";
allow members of "SPSI-AI00-iMG634ABoot";
allow members of "SPSI-AI00-iMG634A-R2Boot";
allow members of "SPSI-AI00-RG634ABoot";
allow members of "SPSI-AI00-RG624ABoot";
allow members of "SPSI-AI00-RG613TXBoot";
}
}

# RG/iMG Remote Management vlan subnet
subnet 10.52.111.64 netmask 255.255.255.192 {
  pool {
    authoritative;
    range 10.52.111.68 10.52.111.126;
    default-lease-time 86400;
    max-lease-time 86400;
    option routers 10.52.111.65;
    option subnet-mask 255.255.255.192;
    option broadcast-address 10.52.111.127;
    option domain-name "spsi.lab.telesyn.corp";
    option domain-name-servers 10.52.201.36;
    allow members of "SPSI-AI00-iBG915FXMgmt";
    allow members of "SPSI-AI00-iMG606BDMgmt";
    allow members of "SPSI-AI00-iMG606BD-R2Mgmt";
    allow members of "SPSI-AI00-iMG613RFMgmt";
    allow members of "SPSI-AI00-iMG616BDMgmt";
    allow members of "SPSI-AI00-iMG616BD-R2Mgmt";
    allow members of "SPSI-AI00-iMG616WMgmt";
    allow members of "SPSI-AI00-iMG646BDMgmt";
    allow members of "SPSI-AI00-iMG646BD-ONMgmt";
    allow members of "SPSI-AI00-iMG646PX-ONMgmt";
    allow members of "SPSI-AI00-iMG626MODMgmt";
    allow members of "SPSI-AI00-iMG646MODMgmt";
    allow members of "SPSI-AI00-iMG726BD-ONMgmt";
    allow members of "SPSI-AI00-iMG726MODMgmt";
    allow members of "SPSI-AI00-iMG746MODMgmt";
    allow members of "SPSI-AI00-iMG1505Mgmt";
    allow members of "SPSI-AI00-iMG1525Mgmt";
    allow members of "SPSI-AI00-iMG2504Mgmt";
```

```
    allow members of "SPSI-AI00-IMG2524Mgmt";
    allow members of "SPSI-AI00-IMG624AMgmt";
    allow members of "SPSI-AI00-IMG624A-R2Mgmt";
    allow members of "SPSI-AI00-IMG634AMgmt";
    allow members of "SPSI-AI00-IMG634A-R2Mgmt";
    allow members of "SPSI-AI00-IMG634WAMgmt";
    allow members of "SPSI-AI00-RG634AMgmt";
    allow members of "SPSI-AI00-RG624AMgmt";
    allow members of "SPSI-AI00-RG613TXMgmt";
    allow members of "SPSI-AI00-ComtrendMgmt";
}
}

# RG/iMG Internet & PC vlan subnet
subnet 10.52.110.64 netmask 255.255.255.224 {
    pool {
        authoritative;
        range 10.52.110.68 10.52.110.94;
        default-lease-time 1200;
        min-lease-time 1200;
        max-lease-time 3600;
        option routers 10.52.110.65;
        option subnet-mask 255.255.255.224;
        option broadcast-address 10.52.110.95;
        option domain-name-servers 10.52.201.36;
        allow members of "SPSI-AI00-Internet";
    }
}

# STB Video vlan subnet
subnet 10.52.111.192 netmask 255.255.255.192 {
    pool {
        authoritative;
        range 10.52.111.196 10.52.111.254;
        default-lease-time 86400;
        max-lease-time 86400;
        option routers 10.52.111.193;
        option subnet-mask 255.255.255.192;
        option broadcast-address 10.52.111.255;
        allow members of "aminet";
        allow members of "thomson";
        allow members of "SPSI-AI00-Video";
    }
}
}
```

13.2.2.4 spsi-ai00-awplus-subnet

```
# spsi-ai00-awplus-subnet for Service Provider Solutions Interop (SPSI) lab Access Island 0,
# AlliedWare Plus access ports for provisioning 3play iMGs
# Jul-7-08 JWS: copied from spsi-ai00-subnet, modified for AW+
# Apr-3-12 JWS: added img1505
```

```
#####
```

```
# AGENT REMOTE ID:
# None, since not supported by AW+ 5.3.3-0.4
# AGENT CIRCUIT ID:
# Vlan 201 (RGBoot)      = vlan201      = 10.52.110.176    255.255.255.240
# Vlan 301 (RGMgmt)     = vlan301     = 10.52.110.192    255.255.255.240
# Vlan 401 (Voice)      = vlan401      = 10.52.110.208    255.255.255.240
# Vlan 501 (Video)      = vlan501      = 10.52.110.224    255.255.255.240
# Vlan 601 (Internet)   = vlan601      = 10.52.110.240    255.255.252.240
```

```
#####
```

```
shared-network SPSI-AI00 {
    # RG/iMG bootstrap vlan subnet
    subnet 10.52.110.176 netmask 255.255.255.240 {
        pool {
            authoritative;
            range 10.52.110.178 10.52.110.190;
            default-lease-time 600;
            max-lease-time 600;
            option routers 10.52.110.177;
            option subnet-mask 255.255.255.240;
            option broadcast-address 10.52.110.191;
            allow members of "SPSI-AI00-AWPLUS-IMG646MODBoot";
            allow members of "SPSI-AI00-AWPLUS-IMG746MODBoot";
            allow members of "SPSI-AI00-AWPLUS-IMG1505Boot";
        }
    }

    # RG/iMG Remote Management vlan subnet
    subnet 10.52.110.192 netmask 255.255.255.240 {
        pool {
            authoritative;
            range 10.52.110.194 10.52.110.206;
            default-lease-time 86400;
            max-lease-time 86400;
            option routers 10.52.110.193;
            option subnet-mask 255.255.255.240;
            option broadcast-address 10.52.110.207;
            option domain-name-servers 10.52.201.36;
            allow members of "SPSI-AI00-AWPLUS-IMG646MODMgmt";
            allow members of "SPSI-AI00-AWPLUS-IMG746MODMgmt";
            allow members of "SPSI-AI00-AWPLUS-IMG1505Mgmt";
        }
    }

    # RG/iMG Internet & PC vlan subnet
    subnet 10.52.110.240 netmask 255.255.255.240 {
        pool {
            authoritative;
            range 10.52.110.242 10.52.110.254;
            default-lease-time 1200;
            min-lease-time 1200;
            max-lease-time 3600;
            option routers 10.52.110.241;
            option subnet-mask 255.255.255.240;
            option broadcast-address 10.52.110.255;
            option domain-name-servers 10.52.201.36;
            allow members of "SPSI-AI00-AWPLUS-Internet";
        }
    }

    # STB Video vlan subnet
    subnet 10.52.110.224 netmask 255.255.255.240 {
        pool {
            authoritative;
```

```
range 10.52.110.226 10.52.110.238;
default-lease-time 86400;
max-lease-time 86400;
option routers 10.52.110.225;
option subnet-mask 255.255.255.240;
option broadcast-address 10.52.110.239;
allow members of "aminet";
allow members of "thomson";
}
}
```

13.2.3 DNS Configuration File

```

options {
allow-transfer { 10.3.0.5; };
directory "/etc/named.d/";
/* 10.3.0.5 is the redundant DNS (slave)
 * 10.4.0.5 is the primary DNS
 * 10.3.0.2 and 166.163.128.5 are two DHCP servers
 * If there is a firewall between you and nameservers you want
 * to talk to, you might need to uncomment the query-source
 * directive below. Previous versions of BIND always asked
 * questions using port 53, but BIND 8.1 uses an unprivileged
 * port by default.
 */
// query-source address * port 53;
};

# Use with the following in named.conf, adjusting the allow list as needed:
key "rndc-key" {
algorithm hmac-md5;
secret "VBd+VWbItNu5ZtKJbRKgqQ==";
};
controls {
inet 0.0.0.0 port 953
allow {127.0.0.1;} keys{"rndc-key"};
};

acl dhcp-srvr {10.3.0.2;166.163.128.5 ;

logging {
channel normal_logs {
severity info; // level 3 debugging to file
file "/var/log/named"; // /var/adm/named
print-time yes; // timestamp log entries
print-category yes; // print category name
print-severity yes; // print severity level
};

category default \{ normal_logs; };
};

/**/
/*DDNS STUFF*/
/**/

/*VOICE REVERSE LOOKUP DDNS*/
zone "0.48.10.in-addr.arpa." {
type master;
allow-update { dhcp-srvr; };
file "ddns/10.48.0.ndb";
};

zone 1.85.10/.in-addr.arpa." {
type master;
allow-update { dhcp-srvr; };
file "ddns/10.85.1.ndb";
};

zone "1.48.10.in-addr.arpa." {
type master;
allow-update { dhcp-srvr; };
file "ddns/10.48.1.ndb";
};

zone "2.48.10.in-addr.arpa." {
type master;
allow-update { dhcp-srvr; };
file "ddns/10.48.2.ndb";
};
zone "3.48.10.in-addr.arpa." {
type master;
allow-update { dhcp-srvr; };
file "ddns/10.48.3.ndb";
};

zone "4.48.10.in-addr.arpa." {
type master;
allow-update { dhcp-srvr; };
file "ddns/10.48.4.ndb";
};

zone "5.48.10.in-addr.arpa." {
type master;
allow-update { dhcp-srvr; };
file "ddns/10.48.5.ndb";
};

```



```
zone "6.48.10.in-addr.arpa." {
    type master;
    allow-update { dhcp-srvr; };
    file "ddns/10.48.6.ndb";
};

zone "7.48.10.in-addr.arpa." {
    type master;
    allow-update { dhcp-srvr; };
    file "ddns/10.48.7.ndb";
};

/*RG FORWARD LOOKUP DDNS*/
zone "rg" {
    type master;
    allow-update { dhcp-srvr; };
    file "ddns/rg.ndb";
};

/**/
/*END OF DDNS*/
/**/

/*Fixed REVERSE LOOKUP DNS files here...*/
zone "2.1.10.in-addr.arpa." {
    type master;
    file "networks/10.1.2.ndb";
};

zone "3.1.10.in-addr.arpa." {
    type master;
    file "networks/10.1.3.ndb";
};

zone "4.1.10.in-addr.arpa." {
    type master;
    file "networks/10.1.4.ndb";
};

zone "5.1.10.in-addr.arpa." {
    type master;
    file "networks/10.1.5.ndb";
};

zone "6.1.10.in-addr.arpa." {
    type master;
    file "networks/10.1.6.ndb";
};

zone "0.3.10.in-addr.arpa." {
    type master;
    file "networks/10.3.0.ndb";
};

zone "0.4.10.in-addr.arpa." {
    type master;
    file "networks/10.4.0.ndb";
};

zone "1.6.10.in-addr.arpa." {
    type master;
    file "networks/10.6.1.ndb";
};

zone "2.6.10.in-addr.arpa." {
    type master;
    file "networks/10.6.2.ndb";
};

zone "1.40.10.in-addr.arpa." {
    type master;
    file "networks/10.40.1.ndb";
};

zone "map" {
    type master;
    file "master/map.ndb";
};

zone "net" {
    type master;
    file "master/net.ndb";
};
```

